

World's Largest Body Hardware
And Specialty Fastener Selection

\$12.50

**100 Year
Anniversary**



Then - Now - and serving you into the Future.

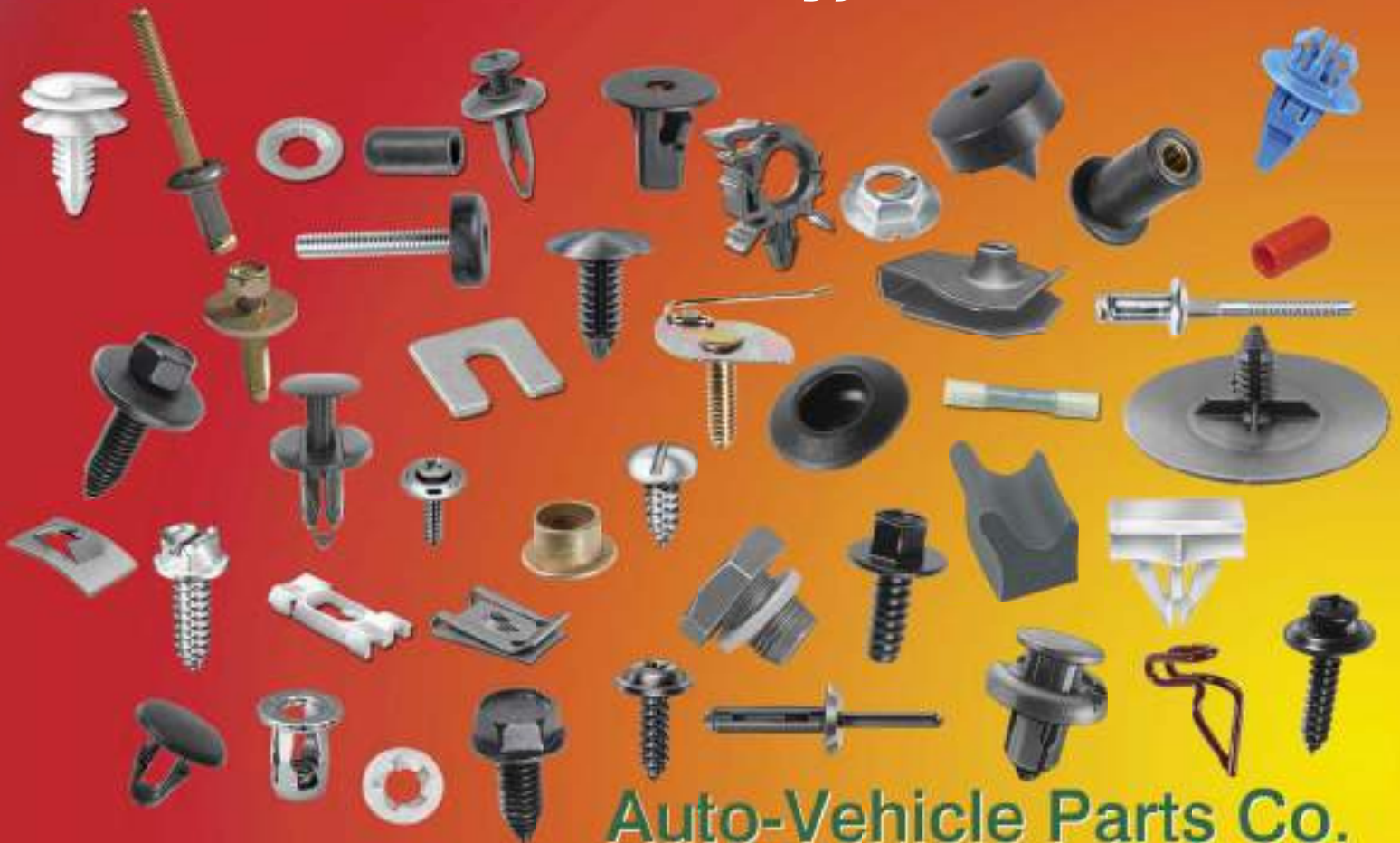

Auto-Vehicle Parts Co.

TAPPING SCREWS

Listed According To Size

Sec. 1



Phillips Oval Head Tapping Screws

Size	Zinc Part No.	Chrome Part No.	Bk. Oxide Part No.	Unit Pkg.	Size	Zinc Part No.	Chrome Part No.	Bk. Oxide Part No.	Unit Pkg.
4 x 3/8"	3062		12893	100	10 x 1-3/4" ...8 Hd	2663			100
4 x 1/2"	3063	3068	12894	100	10 x 1-3/4"	2586			100
4 x 5/8"		5604	12895	100	10 x 2" ...8 Hd	2665			100
4 x 3/4"		3069	12896	100	10 x 2"	2666			100
4 x 1"			12897	100	10 x 2-1/2"	3207			100
6 x 3/8" ...4 Hd		2802		100	12 x 1/2"	8044			100
6 x 1/2"	2571	2698	12795	100	12 x 3/4" ...10 Hd	8049			100
6 x 5/8"	2699	1793		100	12 x 3/4"	8050			100
6 x 3/4"	2700	1794	12796	100	12 x 1"	8056			100
6 x 7/8"	2572			100	12 x 1-1/2" .10 Hd	8061			100
6 x 1"	2702	1796	12797	100	12 x 1-1/2"	8062			100
6 x 1-1/4"	2704	1797	12798	100	12 x 2"	8068			100
8 x 3/8" ...6 Hd	2705	2024		100	14 x 1"	8083			100
8 x 3/8"	3484			100					
8 x 1/2" ...6 Hd	2706	2027	10162	100					
8 x 1/2"	2358	2707	10163	100					
8 x 5/8" ...6 Hd	2708	1421		100					
8 x 5/8"	2574	2709		100					
8 x 3/4" ...6 Hd	1798	1799	10164	100					
8 x 3/4"	2359	2710	10165	100					
8 x 3/4" ...10 Hd		20373		100					
8 x 7/8" ...6 Hd	1800	2711		100					
8 x 7/8"	2575	2712		100					
8 x 1" ...6 Hd	1801	1483	10166	100					
8 x 1"	2360	2713	10167	100					
8 x 1-1/8" ...6 Hd		1802		100					
8 x 1-1/4" ...6 Hd	1803	1423	10168	100					
8 x 1-1/4"	2361	2716	10169	100					
8 x 1-1/2" ...6 Hd	2717	1932	10170	100					
8 x 1-1/2" ...6 Hd		1424		100					
(Special Long Shank)									
8 x 1-1/2"	2362	2718	10171	100					
8 x 1-3/4" ...6 Hd		1933		100					
8 x 2" ...6 Hd	2632			100					
8 x 2"	2633			100					
8 x 2-1/2"	3205			100					
10 x 1/2" ...6 Hd	2720	2656		100					
10 x 1/2" ...8 Hd		2657		100					
10 x 1/2"	2579	2722	11084	100					
10 x 5/8" ...8 Hd		2724		100					
10 x 5/8"	2580			100					
10 x 3/4" ...6Hd	2726			100					
10 x 3/4" ...8 Hd	2727	1717	11087	100					
10 x 3/4"	2581	2728	11086	100					
10 x 1" ...6 Hd	2729	1804		100					
10 x 1" ...8 Hd	2578	2730	11089	100					
10 x 1"	2582	2731	11088	100					
10 x 1-1/8"		1807		100					
10 x 1-1/4" ...8 Hd	2661	2734	11091	100					
10 x 1-1/4"	2583	2735	11090	100					
10 x 1-1/2" ...6 Hd		2046		100					
10 x 1-1/2" ...8 Hd	2662	20374	11093	100					
10 x 1-1/2"	2585		11092	100					

For assortments of Phillips Oval Head Tapping Screws, refer to Fix-Kits 6003 and 6501 in the green pages.



Phillips Oval Head Tek[®] Tapping Screws

Phosphate

Auveco Part No.	Size	Unit Pkg.
16736	8 x 1" ...6 Hd	50
16737	8 x 1-1/4" ...6 Hd	50



Slotted Oval Head Tapping Screws

Bright Zinc Chromate

Auveco Part No.	Size	Unit Pkg.
1432	6 x 1/2"	100
1144	6 x 5/8"	100
1149	8 x 3/4"	100
1137	8 x 1"	100
5616	12 x 5/8"	100
3483	12 x 7/8"	100
5617	14 x 5/8"	100
5618	14 x 2-1/4"	100

Sec. 1

TAPPING SCREWS

Listed According To Size



Pop On Polypropylene Screw Covers & Bases

They're simple to use:

1. Place washer over pilot or starting hole for screw, nail or rivet.
2. Install fastener.
3. Place Snap Cap over washer at slight angle.
4. Simply push Snap Cap down firmly.



Covers

Auveco Part No.	Screw Size	Color	O.D.	Unit Pkg.
13831	#4	Black	1/2"	50
13832	#4	White	1/2"	50
13833	#6	Black	1/2"	50
13834	#6	White	1/2"	50
13835	#8	Black	5/8"	50
13836	#8	White	5/8"	50
13837	#10	Black	5/8"	50
13838	#10	White	5/8"	50

Bases

Auveco Part No.	Screw Size	Use with Cover	Unit Pkg.
13839	#4	13831 & 13832	50
13840	#6	13833 & 13834	50
13841	#8	13835 & 13836	50
13842	#10	13837 & 13838	50



Phillips Flat Head Tapping Screws

Size	Zinc Part No.	Unit Pkg.	Bk. Oxide Part No.	Unit Pkg.
4 x 1/4"	5646	100		
4 x 3/8"	5647	100	12899	100
4 x 1/2"	5648	100	12900	100
4 x 5/8"	5649	100		
4 x 3/4"	5650	100		
6 x 5/16" ...4 Hd.	2736	100		
6 x 1/2" ...4 Hd.	5651	100		
6 x 1/2"	1946	100	12801	100
6 x 5/8"	5653	100		
6 x 3/4" ...4 Hd.	*2803	100		
6 x 3/4"			12802	100
6 x 1"			12803	100
* Chrome				
8 x 3/8" ...6 Hd.	5654	100		
8 x 7/16" ...6 Hd.	1479	100		
8 x 1/2" ...6 Hd.	2804	100	10173	100
8 x 1/2"	5655	100	10172	100
8 x 5/8" ...6 Hd.	5656	100		
8 x 3/4" ...6 Hd.	1712	100	10174	100
8 x 3/4"	2807	100	10175	100
8 x 1" ...6 Hd.	5660	100	10176	100
8 x 1"	5661	100	10177	100
8 x 1-1/4" ...6 Hd.			10178	100
8 x 1-1/4"			10179	100
8 x 1-1/2" ...6 Hd.			12805	50
8 x 1-1/2"			12806	50
10 x 1/2"			12807	100
10 x 3/4"	2810	100	12809	100
10 x 1"	5672	100	12811	50



Metric Torx® Head Tapping Screws

300 Series Stainless Steel

Auveco Part No.	Size	Head Style	Finish	Unit Pkg.
11937	4.2 x 20mm	M7 Oval	Chrome	50
11938	4.2 x 20mm	M7 Oval	Black Ox	50
11944	4.2 x 20mm	M8 Pan	Black Ox	50
14046	4.2 x 25mm	M8 Pan	Black Ox	50
14049	4.2 x 25mm	M8 Pan	Chrome	50
14053	4.2 x 25mm	M7 Oval	Black Ox	50
11945	4.2 x 35mm	M8 Pan	Chrome	25
14047	4.2 x 35mm	M7 Oval	Black Ox	50
14952*	4.2 x 55mm	M8 Pan	Black Ox	50

* Not Fully Threaded



Torx® Insert Bits For Torx® Screws

1" Shank

Auveco Part No.	Bit Size	For Screw Size	Unit Pkg.
12472	T-10	No. 4	1
11949	T-15	No. 6, 8, M4.2	1
11950	T-20	No. 8, M4.2	1
12103	T-25	No. 10	1
14913	T-27	No. 12, 1/4"	1
12104	T-30	1/4"	1
12105	T-40	5/16"	1
14916*	T-55	1/2", 9/16", 5/8"	1

*1-1/4" Shank

Torx® Tools

Torx® Short Arm Key, Power Drive Bits and Hand Drivers are available for installing Torx® Screws. Refer to the "Tools" listing in the Alphabetical Index.

TAPPING SCREWS

Sec. 1



Flat Head Torx® Drive Floor Screws

Thread Cutting Screws - Type F
Phosphate & Oil Finish

Auveco Part No.	Size	Drive Size	Unit Pkg.
12098	1/4-20 x 2"	T-30	50
12100	1/4-20 x 2-1/2"	T-30	50



Slotted Pan Head Tapping Screws

Bright Zinc Chromate

Auveco Part No.	Size	Unit Pkg.
3020	4 x 1/4"	100
3022	4 x 1/2"	100
5636	4 x 7/8"	100
3024	4 x 1"	100
1263	6 x 3/8"	100
1452	6 x 1/2"	100
1453	6 x 5/8"	100
1454	6 x 3/4"	100
1455	6 x 1"	100
5639	6 x 1-3/8"	100
1456	8 x 3/8"	100
1146	8 x 1/2"	100
1092	8 x 5/8"	100
1457	8 x 1"	100
3028	8 x 1-1/2"	100
1458	10 x 1/2"	100
1787	10 x 5/8"	100
1265	10 x 3/4"	100
1459	10 x 1"	100
1460	10 x 1-1/2"	100
1266	10 x 1-3/4"	100
5642	12 x 5/8"	100
1344	12 x 3/4"	100
1346	12 x 1"	100
3032	12 x 1-1/2"	100
1347	14 x 1/2"	100
2039	14 x 5/8"	100
1381	14 x 3/4"	100
1382	14 x 1"	100
3036	14 x 1-1/2"	100
3037	14 x 1-3/4"	100
5645	14 x 2-1/4"	100



Phillips Pan Head Tapping Screws

Size	Zinc Part No.	Unit Pkg.	Bk. Oxide Part No.	Unit Pkg.
4 x 1/4"	3071	100	12902	100
4 x 3/8"	3072	100	12903	100
4 x 1/2"	3073	100	12904	100
4 x 5/8"	5619	100		
4 x 3/4"	3074	100	12905	100
4 x 1"	3075	100		
6 x 1/4"	1935	100		
6 x 3/8"	1936	100	16889	100
6 x 1/2"	1937	100	11917	100
6 x 5/8"	5621	100		
6 x 3/4"	2364	100	11918	100
6 x 1"	3076	100	11919	100
6 x 1-1/8"	5623	100		
6 x 1-1/4"	3077	100	11920	100
6 x 1-1/2"	3078	100		
8 x 3/8"	1939	100		
8 x 1/2"	1940	100	10180	100
8 x 5/8"	5625	100		
8 x 3/4"	2365	100	10181	100
8 x 7/8"	5626	100		
8 x 1"	3079	100	10182	100
8 x 1-1/4"	3080	100	10183	100
8 x 1-1/2"	3081	100	12799	50
10 x 3/8"	1942	100		
10 x 1/2"	1943	100	11921	100
10 x 5/8"	2808	100		
10 x 3/4"	2366	100	11922	100
10 x 7/8"	5629	100		
10 x 1"	3082	100	11923	50
10 x 1-1/4"	3083	100	11924	50
10 x 1-1/2"	3084	100	12800	50
12 x 1/2"	3085	100		
12 x 5/8"	5630	100		
12 x 3/4"	2367	100		
12 x 1"	3086	100		
12 x 1-1/4"	3087	100		
12 x 1-1/2"	3088	100		
14 x 1/2"	3089	100		
14 x 5/8"	5632	100		
14 x 3/4"	3090	100		
14 x 7/8"	5633	100		
14 x 1"	3091	100		
14 x 1-1/4"	3092	100		
14 x 1-1/2"	3093	100		
14 x 1-3/4"	3211	100		
14 x 2"	5634	100		
14 x 2-1/4"	2371	50		

For assortments of Phillips Pan Head Tapping Screws refer to Fix Kits 6004 and 6038 in the green pages.

TAPPING SCREWS

Listed According To Size



Phillips Oval Head Sems® Countersunk Washer Tapping Screws

Size	Chrome Part No.	Unit Pkg.	Bk. Phos Part No.	Unit Pkg.
6 x 5/8"	3537	100	11784	100
6 x 3/4"	3538	100	11785	100
6 x 1"	3539	100	11786	100
8 x 1/2"6 Hd			*16930	100
8 x 5/8"6 Hd	2771	100	11787	100
8 x 3/4"6 Hd	2751	100	11788	100
8 x 1"6 Hd	2772	100	11789	100
8 x 1-1/4"6 Hd	2773	100	11790	100
8 x 1-1/2"6 Hd	14970	50		
10 x 5/8"8 Hd	3465	100	14972	100
10 x 3/4"8 Hd	3466	100	11791	50
10 x 1"8 Hd	3467	100	11792	50
10 x 1-1/4"8 Hd	3468	100	14973	50

* Black Oxide Finish



Phillips Oval Head Sems® Flush Washer Tapping Screws

Size	Chrome Part No.	Bk Oxide Part No.	Unit Pkg.
8 x 1/2"6 Hd		12956	100
8 x 5/8"6 Hd	2774	10652	100
8 x 11/16"6 Hd		10653	100
8 x 7/8"6 Hd	2775		100
8 x 1"6 Hd		12957	100
8 x 1-1/4"6 Hd		10654	100



Countersunk



Flush

Phillips Oval Head Sems® Teks® Finishing Screws With No. 6 Head & No. 2 Drill Point

Size	Washer Type	Chrome Part No.	Phos. Part No.	Unit Pkg.
8 x 5/8"Flush		11448	11453	100
8 x 5/8"Ctrsnk		11449	11454	100
8 x 3/4"Flush			20513	100
8 x 3/4"Ctrsnk		11450	11455	100
8 x 1"Ctrsnk		11451	11456	50
8 x 1-1/4"Ctrsnk		11452	11457	50
8 x 1-1/4"Flush			18460	50



Phillips Flat Top Washer Head Tapping Screws Black E-Coat or Zinc

Size	Washer Head O.D.	Zinc Part No.	Black E-Coat Part No.	Unit Pkg.
6 x 1/2"3/8"			12950	100
6 x 3/4"3/8"			*12951	100
6 x 1"3/8"			*12952	100
8 x 1/2"13/32"		14859	12213	100
8 x 5/8"13/32"		14860	12214	100
8 x 3/4"13/32"		14861	12215	100
8 x 1"13/32"		14862	12216	100
8 x 1-1/4"13/32"			12217	50
8 x 1-1/2"13/32"			12218	50
8 x 2"13/32"			19798	50
10 x 3/4"15/32"			12953	50
10 x 1"15/32"			12954	50
10 x 1-1/4"15/32"			12955	50

*Black Oxide

Black E-Coat Is Excellent For Interior/Exterior Use. 168 Hour Salt Spray



Phillips Pan Head Sems® Tapping Screws Black Phosphate

Auveco Part No.	Size	Washer O.D.	Unit Pkg.
12818	8 x 1/2"	1/2"	50
12820	8 x 3/4"	1/2"	50
12821	8 x 1"	1/2"	50

TAPPING SCREWS

Sec. 1

Listed According To Size



**Slotted Pan Head
Thread Cutting Screws - Type "F"**
Bright Zinc Chromate

Auveco Part No.	Size	Unit Pkg.
5290	8-32 x 1/4"	100
5291	8-32 x 3/8"	100
5292	8-32 x 1/2"	100
5294	8-32 x 3/4"	100
5298	10-24 x 3/8"	100
5301	10-24 x 3/4"	100
5307	1/4-20 x 5/8"	100



**Acorn Indented Hex Washer Head
Tapping Screws
With Phillips Recess**

Auveco Part No.	Size	Hex Size	Washer O.D.	Finish	Unit Pkg.
13736	6 x 1/2"	1/4"	5/16"	Blk Phos.	100
13727	6 x 3/4"	1/4"	5/16"	Zinc	100
13728	6 x 1"	1/4"	5/16"	Zinc	100



Drill Screws
Bright Zinc Chromate
Pinch Point Slotted Hex Washer Head
Tapping Screws

Auveco Part No.	Size	Hex Size	Unit Pkg.
3367	6 x 3/8"	1/4"	100
3374	8 x 1/2"	1/4"	100
3376	8 x 3/4"	1/4"	100

Use Auveco Magnetic Socket Tool No. 7767

Self-Piercing Screws
Zinc



For material thickness up to .060
Use with magnetic chuck 7767

Auveco Part No.	Size	Hex Size	Unit Pkg.
12365	7 x 1/2"	1/4"	100
12367	8 x 5/8"	1/4"	100
12368	8 x 3/4"	1/4"	50
12369	10 x 1/2"	1/4"	50
12370	10 x 3/4"	1/4"	50



**Hexagon Washer Head
Thread Cutting Screws - Type "F"**
Bright Zinc Chromate

Auveco Part No.	Size	Hex Size	Unit Pkg.
5759	6-32 x 3/8"	1/4"	100
5764	6-32 x 1"	1/4"	100
5766	8-32 x 3/8"	1/4"	100
5767	8-32 x 1/2"	1/4"	100
5768	8-32 x 5/8"	1/4"	100
5769	8-32 x 3/4"	1/4"	100
5773	10-24 x 3/8"	5/16"	100
5774	10-24 x 1/2"	5/16"	100
5775	10-24 x 5/8"	5/16"	100
5776	10-24 x 3/4"	5/16"	100
5778	10-24 x 1"	5/16"	100
8437	12-24 x 1/2"	5/16"	100
8438	12-24 x 3/4"	5/16"	100
8439	12-24 x 1"	5/16"	100
5781	1/4-20 x 3/8"	3/8"	100
5782	1/4-20 x 1/2"	3/8"	100
5783	1/4-20 x 5/8"	3/8"	100
5784	1/4-20 x 3/4"	3/8"	100
5786	1/4-20 x 1"	3/8"	100
5787	1/4-20 x 1-1/4"	3/8"	100
8441	5/16-18 x 1/2"	1/2"	100
8442	5/16-18 x 3/4"	1/2"	100
8443	5/16-18 x 1"	1/2"	100
8444	5/16-18 x 1-1/4"	1/2"	100
15355	5/16-18 x 1-1/2"	1/2"	50
15356	5/16-18 x 1-3/4"	1/2"	50
11294	3/8-16 x 3/4"	9/16"	50
11295	3/8-16 x 1"	9/16"	50
11296	3/8-16 x 1-1/4"	9/16"	25
11297	3/8-16 x 1-1/2"	9/16"	25
15357	3/8-16 x 1-3/4"	9/16"	25
15358	3/8-16 x 2"	9/16"	25

TRI-LOBULAR "TT" SCREWS



Thread Cutting • Grade 5 • Zinc Plated

Auveco Part No.	Size	Unit Pkg.
-----------------	------	-----------

Phillips Pan Head

16491	8-32 x 3/4"	100
-------	-------------	-----

TAPPING SCREWS

Listed According To Size



Teks®

Self-Drilling Self-Tapping Screws



Indented Hex Head Tapping Screws

Bright Zinc Chromate

Size	Hex Size	Zinc Part No.	Unit Pkg.	Bk. Oxide Part No.	Unit Pkg.
Phillips Pan Head					
#2 Teks® Point					
8 x 7/16"		9604	100		
8 x 1/2"		9605	100	16033	100
8 x 3/4"		9606	100	16034	100
8 x 1"		11904	100	16035	50
10 x 1/2"		9607	100	16036	50
10 x 3/4"		9608	100	16037	50
10 x 1"		9609	100	16038	50
12 x 1"		11905	50		

Hex Washer Head					
#2 Teks® Point					
8 x 7/16"	1/4"	9610	100		
8 x 1/2"	1/4"	9611	100	16039	100
8 x 3/4"	1/4"	9612	100	16040	100
8 x 1"	1/4"	11906	100	16041	50
8 x 1-1/4"	1/4"	11907	50		
8 x 1-1/2"	1/4"	11908	50		
10 x 1/2"	5/16"	9613	100	16042	50
10 x 5/8"	5/16"	9614	100		
10 x 3/4"	5/16"	9615	100	16043	50
10 x 1"	5/16"	9616	100	16044	50

Super Teks® - Hex Washer Head					
#3 Teks® Point					
10 x 1-1/4"	5/16"	11909	50		
10 x 1-1/2"	5/16"	11910	50		
12 x 3/4"	5/16"	9617	100		
12 x 1"	5/16"	11911	25		
12 x 1-1/4"	5/16"	11912	25		
12 x 1-1/2"	5/16"	11913	25		
14 x 3/4"	3/8"	9620	100		
14 x 1"	3/8"	11914	25		
14 x 1-1/4"	3/8"	11915	25		
14 x 1-1/2"	3/8"	11916	25		

Teks® Point Material Thickness		
Screw Size	#2 Point	#3 Point
#8	.035" - .100"	.100" - .140"
#10	.035" - .110"	.110" - .175"
#12	.035" - .140"	.110" - .210"
#14	.035" - .175"	.110" - .210"

For an assortment of Teks® Tapping Screws see Fix-Kit No. 6144 in the green pages.

Auveco Part No.	Size	Hex Size	Unit Pkg.
2389	8 x 1/2"	1/4"	100
5676	8 x 5/8"	1/4"	100
2485	8 x 3/4"	1/4"	100
2486	8 x 1"	1/4"	100
3212	8 x 1-1/4"	1/4"	100
8011	10 x 1/2"	5/16"	100
2487	10 x 3/4"	5/16"	100
3214	10 x 1-1/4"	5/16"	100
3215	10 x 1-1/2"	5/16"	100
1780	12 x 1/2"	5/16"	100
2107	12 x 3/4"	5/16"	100
3216	12 x 1"	5/16"	100
3217	12 x 1-1/4"	5/16"	100
2012	14 x 1/2"	3/8"	100
2391	14 x 5/8"	3/8"	100
1781	14 x 3/4"	3/8"	100
2109	14 x 3/4"	7/16"	100
2266	14 x 1"	7/16"	100
2267	14 x 1-1/4"	7/16"	100
3219	14 x 1-1/2"	7/16"	100
5685	14 x 2"	7/16"	100
2110	5/16 x 3/4"	1/2"	100
2268	5/16 x 1"	1/2"	100
2269	5/16 x 1-1/4"	1/2"	100
3220	5/16 x 1-1/2"	1/2"	100
5329	3/8 x 3/4"	9/16"	50
5330	3/8 x 1"	9/16"	50
5331	3/8 x 1-1/4"	9/16"	50
5332	3/8 x 1-1/2"	9/16"	50



Phillips Oval Head Teks® Tapping Screws

Phosphate

Auveco Part No.	Size	Unit Pkg.
16736	8 x 1".....6 Hd.	50
16737	8 x 1-1/4".....6 Hd.	50

TAPPING SCREWS

Listed According To Size



Hexagon Washer Head Tapping Screws
(Washer Attached Solid To Head)

Size	Hex Size	Zinc Part No.	Unit Pkg.	Bk Oxide Part No.	Unit Pkg.
10 x 1/2"	5/16"	2369	100	16149	100
10 x 5/8"	5/16"	2809	100		
12 x 5/8"	5/16"	2967	100		
12 x 3/4"	5/16"	2968	100		
12 x 1"	5/16"	2969	100		
14 x 1/2"	3/8"	9825	100		
14 x 5/8"	3/8"	2370	100		
14 x 3/4"	3/8"	2330	100	16152	100
14 x 3/4"	7/16"	2973	100		
14 x 1"	3/8"	2974	100		
14 x 1-1/2"	3/8"	2976	100		
5/16 x 3/4"	7/16"	2978	100		
5/16 x 1"	7/16"	2979	100		
5/16 x 1-1/4"	7/16"	2980	100		
5/16 x 1-1/2"	7/16"	2981	100		



Hexagon Head Sems® Tapping Screws
(Washer Loose From Head)

Bright Zinc Chromate

Auveco Part No.	Size	Hex Size	Washer O.D.	Unit Pkg.
2983	12 x 3/4"	7/16"	5/8"	100
2604	14 x 3/4"	3/8"	5/8"	100
2988	14 x 3/4"	7/16"	21/32"	100
2605	14 x 1"	3/8"	21/32"	100
2989	14 x 1"	7/16"	21/32"	100
2991	14 x 1-1/2"	7/16"	21/32"	100
2994	5/16 x 1"	7/16"	11/16"	100
2996	5/16 x 1-1/2"	7/16"	11/16"	100



Slotted Hexagon Head Tapping Screws

Bright Zinc Chromate

Auveco Part No.	Size	Hex Size	Unit Pkg.
3342	6 x 3/4"	1/4"	100
3350	8 x 1"	1/4"	100
3352	10 x 3/8"	5/16"	100



Slotted Hexagon Washer Head Tapping Screws

Bright Zinc Chromate

Auveco Part No.	Size	Hex Size	Unit Pkg.
3367	6 x 3/8"	1/4"	100
3368	6 x 1/2"	1/4"	100
3369	6 x 5/8"	1/4"	100
3373	8 x 3/8"	1/4"	100
3374	8 x 1/2"	1/4"	100
3375	8 x 5/8"	1/4"	100
3376	8 x 3/4"	1/4"	100
3378	8 x 1"	1/4"	100
3379	8 x 1-1/4"	1/4"	100
3380	10 x 3/8"	5/16"	100
3381	10 x 1/2"	5/16"	100
3382	10 x 5/8"	5/16"	100
3383	10 x 3/4"	5/16"	100
3385	10 x 1"	5/16"	100
3386	10 x 1-1/4"	5/16"	100
3387	10 x 1-1/2"	5/16"	100
3388	12 x 1/2"	5/16"	100
3389	12 x 5/8"	5/16"	100
3390	12 x 3/4"	5/16"	100
3392	12 x 1"	5/16"	100
3393	12 x 1-1/4"	5/16"	100
3394	12 x 1-1/2"	5/16"	100



Hex Head Lag Screws
Zinc Plated

Auveco Part No.	Size	Hex Size	Unit Pkg.
9091	5/16 x 2-1/2"	1/2"	50
9100	3/8 x 4"	9/16"	25



Phillips Flat Head Wood Screws
Steel - Zinc Plated

Auveco Part No.	Size	Unit Pkg.
9555	6 x 1/2"	100
9556	6 x 3/4"	100
9557	6 x 1"	100
9564	8 x 3/4"	100
9565	8 x 1"	100
9566	8 x 1-1/4"	100
9568	8 x 1-3/4"	100
9569	10 x 3/4"	100
9570	10 x 1"	100
9571	10 x 1-1/4"	100
9572	10 x 1-1/2"	100
9575	12 x 1"	100
9576	12 x 1-1/4"	100
9577	12 x 1-1/2"	100
9578	12 x 2"	100
9581	14 x 1-1/2"	100
9582	14 x 2"	100



Hex Washer Head Spin Lock Bolts

Black Phosphate • Grade 2 • Case Hardened

Auveco Part No.	Size	Hex	Washer Head O.D.	Unit Pkg.
2753*	1/4-20 x 5/8"	3/8"	5/8"	100
3615	5/16-18 x 3/4"	1/2"	13/16"	100
5711	5/16-18 x 1"	1/2"	13/16"	50
5713	5/16-18 x 1-1/4"	1/2"	13/16"	50
2688	5/16-24 x 1"	1/2"	13/16"	50
10296*	3/8-16 x 1"	9/16"	3/4"	50

*Not Dog Point



Slotted Oval Head Machine Screws
Zinc Plated

Auveco Part No.	Size	Unit Pkg.
2354	10-24 x 1-1/2"	100



Phillips Oval Head Machine Screws

Size	Chrome Part No.	Zinc Part No.	Unit Pkg.
6-32 x 3/8"		16362	100
6-32 x 1/2"		16363	100
6-32 x 3/4"		16364	100
6-32 x 1-1/4"		16365	100
8-32 x 1/2"	2299	16368	100
8-32 x 3/4"		16369	100
8-32 x 3/4" 6 Hd.	1863		100
8-32 x 1"		16370	100
8-32 x 1-1/4"		16371	100
8-32 x 1-1/2"		16372	50
10-24 x 1/2"		1877	100
10-24 x 3/4"	1934	16375	100
10-24 x 1"		16376	100
10-24 x 1-1/4"		16377	100
10-24 x 1-1/2"		16378	100
10-32 x 3/8"		16379	100
10-32 x 1/2"		16380	100
10-32 x 3/4"		16381	100
10-32 x 1" 8 Hd.	1413		100
10-32 x 1"		16382	100
10-32 x 1-1/4"		16383	50
10-32 x 1-1/2"		16384	50
1/4-20 x 1/2"		16385	50
1/4-20 x 3/4"		16386	50
1/4-20 x 1"		16387	50
1/4-20 x 1-1/4"		16388	50
1/4-20 x 1-1/2"		16389	50



Slotted Round Head Machine Screws
Plain Brass

Auveco Part No.	Size	Unit Pkg.
3854	10-24 x 1"	100
3859	10-32 x 5/8"	100



Phillips Pan Head Machine Screws

Zinc Plated

Auveco Part No.	Size	Unit Pkg.
15374	6-32 x 3/8"	100
15375	6-32 x 1/2"	100
15376	6-32 x 3/4"	100
15377	6-32 x 1"	100
15378	6-32 x 1-1/4"	100
15379	6-32 x 1-1/2"	100
15380	8-32 x 3/8"	100
15381	8-32 x 1/2"	100
15382	8-32 x 3/4"	100
15383	8-32 x 1"	100
15385	8-32 x 1-1/2"	100
15386	10-24 x 3/8"	100
15387	10-24 x 1/2"	100
15388	10-24 x 3/4"	100
15389	10-24 x 1"	100
15390	10-24 x 1-1/4"	100
15391	10-24 x 1-1/2"	50
15392	10-32 x 3/8"	100
15393	10-32 x 1/2"	100
15394	10-32 x 3/4"	100
15395	10-32 x 1"	100
15396	10-32 x 1-1/4"	100
15397	10-32 x 1-1/2"	50
15398	1/4-20 x 1/2"	100
15399	1/4-20 x 3/4"	100
15400	1/4-20 x 1"	50
15401	1/4-20 x 1-1/4"	50
15402	1/4-20 x 1-1/2"	50
15403	1/4-20 x 1-3/4"	50
15404	1/4-20 x 2"	50



Slotted Round Head Machine Screws

Bright Zinc Chromate

Auveco Part No.	Size	Unit Pkg.
5700	6-32 x 3/8"	100
2530	6-32 x 1/2"	100
2531	6-32 x 3/4"	100
2532	6-32 x 1"	100
8588	6-32 x 1-1/2"	100
5702	8-32 x 3/8"	100
2533	8-32 x 1/2"	100
2534	8-32 x 3/4"	100
2535	8-32 x 1"	100
8589	8-32 x 1-1/2"	100
8590	10-32 x 3/8"	100
2536	10-32 x 1/2"	100
2537	10-32 x 3/4"	100
2538	10-32 x 1"	100
2539	10-32 x 1-1/4"	100
2540	10-32 x 1-1/2"	100
2541	10-24 x 1/2"	100
2542	10-24 x 3/4"	100
2543	10-24 x 1"	100
2544	10-24 x 1-1/4"	100
2545	10-24 x 1-1/2"	100
8594	10-24 x 2"	100
2546	12-24 x 1/2"	100
5704	12-24 x 3/4"	100
2548	12-24 x 1"	100
2550	12-24 x 1-1/2"	100
8029	1/4-20 x 1/2"	100
8030	1/4-20 x 3/4"	100
8031	1/4-20 x 1"	100
8033	1/4-20 x 1-1/2"	100
8035	1/4-20 x 2"	100
8036	1/4-20 x 2-1/2"	100



Round Head Stove Bolts & Hex Nuts

Bright Zinc Chromate
U.S.S. Coarse Thread

Auveco Part No.	Size	Unit Pkg.
5697	1/8 x 1"	100
3711	3/16 x 1/2"	100
3712	3/16 x 3/4"	100
3713	3/16 x 1"	100
3715	3/16 x 1-1/2"	100
3716	3/16 x 1-3/4"	100
3717	3/16 x 2"	100
3718	1/4 x 1/2"	100
3719	1/4 x 3/4"	100
3720	1/4 x 1"	100
3722	1/4 x 1-1/2"	100
3724	1/4 x 2"	100

For assortments of Slotted Round Head Machine Screws refer to Fix Kits 6011 and 6503 in the green pages.



Phillips Round Head Machine Screws

Zinc Plated

Auveco Part No.	Size	Unit Pkg.
16407	6-32 x 1/2"	100
16411	8-32 x 1"	100
16412	10-32 x 1/2"	100
16413	10-32 x 3/4"	100
16416	10-24 x 3/4"	100



Carriage Bolts With Hex Nuts
U.S.S. Coarse Thread • Zinc Plated • Grade 2

Auveco Part No.	Size	Unit Pkg.	Auveco Part No.	Size	Unit Pkg.
9482	1/4 x 1"	50	9498	3/8 x 1"	25
9483	1/4 x 1-1/2"	50	9499	3/8 x 1-1/2"	25
9484	1/4 x 2"	50	9500	3/8 x 2"	25
9485	1/4 x 2-1/2"	50	9501	3/8 x 3"	25
9486	1/4 x 3"	50	9502	3/8 x 4"	25
9487	1/4 x 4"	25	9503	3/8 x 5"	25
9489	1/4 x 6"	25			
9490	5/16 x 1"	50	9507	1/2 x 2"	10
9491	5/16 x 1-1/2"	50	9509	1/2 x 4"	10
9492	5/16 x 2"	25	9510	1/2 x 6"	10
9493	5/16 x 3"	25			
9494	5/16 x 4"	25			



Socket Head Set Screws
Cup Point



Auveco Part No.	Size	Unit Pkg.	Use Tool No.	Part No. USS	Part No. SAE	Size	Unit Pkg.	Use Tool No.
5365	6-32 x 3/16"	50	5414					
5366	6-32 x 1/4"	50	5414					
5367	6-32 x 5/16"	50	5414					
5368	6-32 x 3/8"	50	5414					
5369	8-32 x 3/16"	50	5415					
5370	8-32 x 1/4"	50	5415					
5371	8-32 x 5/16"	50	5415					
5372	8-32 x 3/8"	50	5415					
5373	8-32 x 1/2"	50	5415					

Part No. USS	Part No. SAE	Size	Unit Pkg.	Use Tool No.
--------------	--------------	------	-----------	--------------

#10 U.S.S. (Coarse) Threads Per Inch: 24
S.A.E. (Fine) Threads Per Inch: 32

5374	5394	10 x 3/16"	50	
5375	5395	10 x 1/4"	50	
5376	5396	10 x 5/16"	50	
5377	5397	10 x 3/8"	50	
5378	5398	10 x 1/2"	50	

1/4" U.S.S. (Coarse) Threads Per Inch: 20
S.A.E. (Fine) Threads Per Inch: 28

5379	5399	1/4 x 1/4"	50	5417
5380	5400	1/4 x 5/16"	50	5417
5381	5401	1/4 x 3/8"	50	5417
5382	5402	1/4 x 7/16"	50	5417
5383	5403	1/4 x 1/2"	50	5417

*Fold-up Key Set

Note: All Socket Wrenches packed 10 per Unit Package except Key Sets 7977 & 7978 which are packed 1 per Unit Package
For an assortment of Socket Head Set Screws, see Fix-Kit No. 6073 in the green pages.

5/16" U.S.S. (Coarse) Threads Per Inch: 18
S.A.E. (Fine) Threads Per Inch: 24

5384	5404	5/16 x 1/4"	50	7977*
5385	5405	5/16 x 5/16"	50	7977*
5386	5406	5/16 x 3/8"	50	7977*
5387	5407	5/16 x 7/16"	50	7977*
5388	5408	5/16 x 1/2"	50	7977*

3/8" U.S.S. (Coarse) Threads Per Inch: 16
S.A.E. (Fine) Threads Per Inch: 24

5389	5409	3/8 x 5/16"	25	7978*
5390	5410	3/8 x 3/8"	25	7978*
5391	5411	3/8 x 7/16"	25	7978*
5392	5412	3/8 x 1/2"	25	7978*
5393	5413	3/8 x 5/8"	25	7978*

7/16" U.S.S. (Coarse) Threads Per Inch: 14
S.A.E. (Fine) Threads Per Inch: 20

15898	15905	7/16 x 3/8"	25	7978*
-------	-------	-------------	----	-------

1/2" U.S.S. (Coarse) Threads Per Inch: 13
S.A.E. (Fine) Threads Per Inch: 20

	15907	1/2 x 3/8"	25	7978*
15902		1/2 x 7/16"	25	7978*
15903		1/2 x 1/2"	25	7978*
	15910	1/2 x 5/8"	25	7978*

Sec. 2

CAP SCREWS



Grade 5

**Bright Zinc Chromate
Medium Carbon Heat Treated Steel
120,000 P.S.I. Minimum Tensile Strength
Head is Identified With 3 Radial Lines**

Size	Part No. USS	Part No. SAE	Unit Pkg.
------	-----------------	-----------------	--------------

1/4"

U.S.S. (Coarse) Threads Per Inch: 20
S.A.E. (Fine) Threads Per Inch: 28

1/4 x 1/2"	*5434	*5495	100
1/4 x 5/8"	*5435		100
1/4 x 3/4"	*5436	*5497	100
1/4 x 1"	*5438	*5499	100
1/4 x 1-1/4"	5439	5500	100
1/4 x 1-1/2"	5440	5501	100
1/4 x 1-3/4"	5441		100
1/4 x 2"	5442		100
1/4 x 2-1/4"	5443		100
1/4 x 2-1/2"	5444	5505	100
1/4 x 2-3/4"	5445		100
1/4 x 3"	5446		100
1/4 x 3-1/2"	8449		100

5/16"

U.S.S. (Coarse) Threads Per Inch: 18
S.A.E. (Fine) Threads Per Inch: 24

5/16 x 1/2"	*5447		100
5/16 x 5/8"	*5448		100
5/16 x 3/4"	*5449	*5510	100
5/16 x 7/8"	*5450		100
5/16 x 1"	*5451	*5512	100
5/16 x 1-1/4"	*5452	*5513	100
5/16 x 1-1/2"	5453	5514	100
5/16 x 1-3/4"	5454		100
5/16 x 2"	5455	5516	50
5/16 x 2-1/4"	5456		50
5/16 x 2-1/2"	5457		50
5/16 x 3"	5459		50
5/16 x 3-1/2"	5461		50
5/16 x 4"	8450		50

3/8"

U.S.S. (Coarse) Threads Per Inch: 16
S.A.E. (Fine) Threads Per Inch: 24

3/8 x 5/8"	*5462		50
3/8 x 3/4"	*5463	*5524	50
3/8 x 7/8"	*5464		50
3/8 x 1"	*5465	*5526	50
3/8 x 1-1/4"	*5466	*5527	50
3/8 x 1-1/2"	5467	5528	50
3/8 x 1-3/4"	5468		50
3/8 x 2"	5469	5530	50
3/8 x 2-1/4"	5470		50
3/8 x 2-1/2"	5471		50
3/8 x 3"	5472	5533	50
3/8 x 3-1/2"	5473		50
3/8 x 4"	5474		50
3/8 x 4-1/2"	8096		25
3/8 x 5"	8097		25

*Items Threaded To Head



Grade 5

**Bright Zinc Chromate
Medium Carbon Heat Treated Steel
120,000 P.S.I. Minimum Tensile Strength
Head is Identified With 3 Radial Lines**

Size	Part No. USS	Part No. SAE	Unit Pkg.
------	-----------------	-----------------	--------------

7/16"

U.S.S. (Coarse) Threads Per Inch: 14
S.A.E. (Fine) Threads Per Inch: 20

7/16 x 3/4"	*5475		50
7/16 x 1"	*5476	*5537	50
7/16 x 1-1/4"	*5477	*5538	50
7/16 x 1-1/2"	*5478	*5539	50
7/16 x 1-3/4"	5479		50
7/16 x 2"	5480		25
7/16 x 2-1/2"	5481	5542	25
7/16 x 3"	5482		25
7/16 x 3-1/2"	5483		25
7/16 x 4"	5484		25

1/2"

U.S.S. (Coarse) Threads Per Inch: 13
S.A.E. (Fine) Threads Per Inch: 20

1/2 x 3/4"	*5485		50
1/2 x 1"	*5486	*5547	50
1/2 x 1-1/4"	*5487		50
1/2 x 1-1/2"	*5488		25
1/2 x 1-3/4"	*5489	*5550	25
1/2 x 2"	5490	5551	25
1/2 x 2-1/2"	5491		25
1/2 x 3"	5492	5553	25
1/2 x 3-1/2"	5493		25
1/2 x 4"	5494		25
1/2 x 4-1/2"	8104		25
1/2 x 5"	8105		25
1/2 x 6"	8107		25

5/8"

U.S.S. (Coarse) Threads Per Inch: 11
S.A.E. (Fine) Threads Per Inch: 18

5/8 x 1"	*9520		25
5/8 x 1-1/2"	*9521	*9528	25
5/8 x 2"	*9522	*9529	25
5/8 x 2-1/2"	9523		25
5/8 x 3"	9524		25
5/8 x 3-1/2"	9525		25
5/8 x 4"	9526		25

3/4"

U.S.S. (Coarse) Threads Per Inch: 10

3/4 x 2"	*8453		10
3/4 x 2-1/2"	*8454		10
3/4 x 3"	8455		10
3/4 x 3-1/2"	8456		10

*Items Threaded To Head

Refer to Assortment 1020 in the green pages

CAP SCREWS



Grade 8

**Zinc & Yellow Dichromate
Medium Carbon Alloy Steel
150,000 P.S.I. Minimum Tensile Strength
Head Is Identified With 6 Radial Lines**

Size	Part No. USS	Part No. SAE	Unit Pkg.
1/4"	U.S.S. (Coarse) Threads Per Inch: 20 S.A.E. (Fine) Threads Per Inch: 28		
1/4 x 1/2"	*9118		50
1/4 x 3/4"	*9119	*9174	50
1/4 x 1"	*9120		50
1/4 x 1-1/4"	9121		50
1/4 x 1-1/2"	9122	9177	50
1/4 x 2"	9124		50
1/4 x 2-1/4"	9125		25
1/4 x 2-1/2"	9126		25

5/16"	U.S.S. (Coarse) Threads Per Inch: 18 S.A.E. (Fine) Threads Per Inch: 24		
5/16 x 1/2"	*9127		50
5/16 x 3/4"	*9128		50
5/16 x 1"	*9129	*9184	50
5/16 x 1-1/4"	*9130		50
5/16 x 1-1/2"	9131	9186	50
5/16 x 1-3/4"	9132		50
5/16 x 2"	9133	9188	50
5/16 x 2-1/2"	9134		25
5/16 x 3"	9135		25

3/8"	U.S.S. (Coarse) Threads Per Inch: 16 S.A.E. (Fine) Threads Per Inch: 24		
3/8 x 3/4"	*9136	*9191	50
3/8 x 1"	*9137	*9192	50
3/8 x 1-1/4"	*9138	*9193	50
3/8 x 1-1/2"	9139	*9194	50
3/8 x 2"	9140		25
3/8 x 2-1/2"	9141		25
3/8 x 3"	9142		25
3/8 x 3-1/2"	17028		15
3/8 x 4"	9143		25

*Items Threaded To Head



Grade 8

**Zinc & Yellow Dichromate
Medium Carbon Alloy Steel
150,000 P.S.I. Minimum Tensile Strength
Head Is Identified With 6 Radial Lines**

Size	Part No. USS	Part No. SAE	Unit Pkg.
7/16"	U.S.S. (Coarse) Threads Per Inch: 14 S.A.E. (Fine) Threads Per Inch: 20		
7/16 x 1"	*9144	*9199	25
7/16 x 1-1/4"	*9145		25
7/16 x 1-1/2"	*9146	*9201	25
7/16 x 2"	9147		25
7/16 x 2-1/2"	9148	9203	25
7/16 x 3"	9149		25
7/16 x 4"	9150		25
7/16 x 5-1/2"	17031		10

1/2"	U.S.S. (Coarse) Threads Per Inch: 13 S.A.E. (Fine) Threads Per Inch: 20		
1/2 x 1"	*9151		25
1/2 x 1-1/4"	*9152		25
1/2 x 1-1/2"	*9153	*9208	25
1/2 x 1-3/4"	*9154		25
1/2 x 2"	9155	9210	25
1/2 x 2-1/2"	9156		25
1/2 x 2-3/4"		17983	10
1/2 x 3"	9157	9212	10
1/2 x 4"	9158		10
1/2 x 5"	9159		10

5/8"	U.S.S. (Coarse) Threads Per Inch: 11 S.A.E. (Fine) Threads Per Inch: 18		
5/8 x 1-1/2"	*9160		10
5/8 x 2"	*9161		10
5/8 x 2-1/2"	9162		10
5/8 x 3"	9163		10
5/8 x 3-1/2"	17499		10
5/8 x 4"	9164	9219	10
5/8 x 5"	9165		10

3/4"	U.S.S. (Coarse) Threads Per Inch: 10 S.A.E. (Fine) Threads Per Inch: 16		
3/4 x 2"	*9167		10
3/4 x 3"	9169	9224	10
3/4 x 3-1/2"	9170		10
3/4 x 4"	9171		10
3/4 x 5"	9172		10

* Items Threaded to Head

Refer to Assortment 1030 in the green pages

STAINLESS STEEL

18-8 (300 SERIES)



**Stainless Steel Phillips
Pan Head Tapping Screws**

Auveco Part No.	Size	Unit Pkg.
13265	6 x 1/2"	100
13266	6 x 3/4"	100
13267	6 x 1"	100
13268	6 x 1-1/4"	100
13269	8 x 1/2"	100
13270	8 x 3/4"	50
13271	8 x 1"	50
13272	8 x 1-1/4"	50
13273	8 x 1-1/2"	25
13274	10 x 1/2"	100
13275	10 x 3/4"	50
13276	10 x 1"	50
13277	10 x 1-1/4"	50
13278	10 x 1-1/2"	25
13279	10 x 1-3/4"	25
13280	12 x 1/2"	50
13281	12 x 3/4"	50
13282	12 x 1"	50
13283	12 x 1-1/4"	25
13284	12 x 1-1/2"	25
21609	14 x 3/4"	100



**Stainless Steel Phillips
Oval Head Tapping Screws**

Auveco Part No.	Size	Unit Pkg.
9399	6 x 1/2"	100
9400	6 x 3/4"	100
9401	6 x 1"	100
9402	6 x 1-1/4"	100
9403	8 x 1/2"	100
9404	8 x 3/4"	100
9405	8 x 1"	100
9406	8 x 1-1/4"	100
9407	8 x 1-1/2"	100
9408	10 x 1/2"	100
9409	10 x 3/4"	100
9410	10 x 1"	100
9411	10 x 1-1/4"	100
9412	10 x 1-1/2"	100
13286	10 x 1-3/4"	25
13288	12 x 3/4"	50
13289	12 x 1"	50
13290	12 x 1-1/4"	25
13291	12 x 1-1/2"	25
13292	12 x 1-3/4"	25



**Stainless Steel Slotted
Round Head Machine Screws**

Auveco Part No.	Size	Unit Pkg.
13293	6-32 x 1/4"	100
13294	6-32 x 1/2"	100
13298	8-32 x 1/4"	100
13299	8-32 x 1/2"	100
13300	8-32 x 3/4"	100
13301	8-32 x 1"	100
13302	8-32 x 1-1/4"	50
13304	10-24 x 1/2"	100
13305	10-24 x 3/4"	100
13306	10-24 x 1"	50
13308	10-24 x 1-1/2"	50
13310	10-32 x 1/2"	100
13311	10-32 x 3/4"	100
13312	10-32 x 1"	50
13314	10-32 x 1-1/2"	50
13316	1/4-20 x 3/4"	50
13320	1/4-20 x 1-3/4"	25



**Stainless Steel Phillips Oval Head
Machine Screws**

Auveco Part No.	Size	Unit Pkg.
13322	6-32 x 1/2"	100
13323	6-32 x 3/4"	100
13324	6-32 x 1"	100
13325	6-32 x 1-1/4"	100
13326	8-32 x 1/4"	100
13327	8-32 x 1/2"	100
13328	8-32 x 3/4"	100
13329	8-32 x 1"	100
13330	8-32 x 1-1/4"	50
13331	10-24 x 1/2"	100
13332	10-24 x 3/4"	50
13333	10-24 x 1"	50
13334	10-24 x 1-1/4"	50
13335	10-24 x 1-1/2"	50
13336	10-32 x 1/2"	100
13337	10-32 x 3/4"	50
13338	10-32 x 1"	50
13339	10-32 x 1-1/4"	50
13340	10-32 x 1-1/2"	50
13341	1/4-20 x 1/2"	50
13342	1/4-20 x 3/4"	50
13343	1/4-20 x 1"	25
13344	1/4-20 x 1-1/4"	25
13345	1/4-20 x 1-1/2"	25

STAINLESS STEEL

18-8 (300 SERIES)



U.S.S. Coarse Thread Stainless Steel Hex Head Cap Screws

Auveco Part No.	Bolt Size	Unit Pkg.	Auveco Part No.	Bolt Size	Unit Pkg.
* 13346	1/4-20 x 1/2"	50	*13362	3/8-16 x 1/2"	50
* 13347	1/4-20 x 3/4"	50	*13363	3/8-16 x 3/4"	50
13348	1/4-20 x 1"	50	*13364	3/8-16 x 1"	50
13349	1/4-20 x 1-1/4"	50	13365	3/8-16 x 1-1/4"	25
13350	1/4-20 x 1-1/2"	50	13366	3/8-16 x 1-1/2"	25
13352	1/4-20 x 2"	25	13367	3/8-16 x 1-3/4"	25
* 13353	5/16-18 x 1/2"	50	13368	3/8-16 x 2"	25
* 13354	5/16-18 x 3/4"	25	13370	3/8-16 x 2-1/2"	25
13355	5/16-18 x 1"	25	13391	3/8-16 x 3"	25
13356	5/16-18 x 1-1/4"	25	*13373	1/2-13 x 1"	10
13357	5/16-18 x 1-1/2"	25	*13374	1/2-13 x 1-1/4"	10
13359	5/16-18 x 2"	25	13375	1/2-13 x 1-1/2"	10
13360	5/16-18 x 2-1/4"	25	13377	1/2-13 x 2"	10
13361	5/16-18 x 2-1/2"	25			

* Items Threaded To Head



Stainless Steel Cotter Pins Extended Prong Type

Auveco Part No.	Size	Rec. Hole Size	Unit Pkg.	Auveco Part No.	Size	Rec. Hole Size	Unit Pkg.
13409	1/16 x 3/4"	.078	100	13422	1/8 x 1-1/2"	.141	50
13410	1/16 x 1"	.078	100	13424	1/8 x 2"	.141	25
13411	3/32 x 1/2"	.109	100	13426	1/8 x 2-1/2"	.141	25
13412	3/32 x 3/4"	.109	100	13429	5/32 x 1-1/4"	.172	25
13413	3/32 x 1"	.109	100	13430	5/32 x 1-1/2"	.172	25
13414	3/32 x 1-1/4"	.109	50	13431	5/32 x 1-3/4"	.172	25
13415	3/32 x 1-1/2"	.109	50	13434	5/32 x 2-1/2"	.172	25
13417	3/32 x 2"	.109	50				
13420	1/8 x 1"	.141	50				
13421	1/8 x 1-1/4"	.141	50				

STAINLESS STEEL

18-8 (300 SERIES)

Stainless Steel Wing Nuts



Auveco Part No.	Size	Wing Spread (A)		Overall Height (B)		Between Wing (c)		Unit Pkg.
		Max.	Min.	Max.	Min.	Max.	Min.	
13256	10-24	.91	.78	.47	.34	.27	.22	25
13258	1/4-20	1.10	.97	.57	.43	.39	.26	25

Stainless Steel Hex Machine Screw Nuts



Auveco Part No.	Size	Hex Width	Unit Pkg.
13260	6-32	5/16"	100
13261	8-32	11/32"	100
13262	10-24	3/8"	100
13263	10-32	3/8"	100
13264	1/4-20	7/16"	100

Stainless Steel Nylon Insert Lock Nuts



Auveco Part No.	Size	Hex Width	Unit Pkg.
13239	6-32	5/16"	50
13240	8-32	11/32"	50
13241	10-24	3/8"	50
13242	10-32	3/8"	50
13243	1/4-20	7/16"	50
13244	5/16-18	1/2"	25
13245	3/8-16	9/16"	25
13246	1/2-13	3/4"	10

Stainless Steel Acorn Nuts



Auveco Part No.	Size	Hex Width	Unit Pkg.
13248	6-32	5/16"	25
13249	8-32	5/16"	25
13250	10-24	3/8"	25
13251	10-32	3/8"	25
13252	1/4-20	7/16"	25
13253	5/16-18	9/16"	10

Stainless Steel Medium Split Washers



Auveco Part No.	Size	O.D.	Thick-ness	Unit Pkg.
13400	#6 (1/8")	1/4"	.031	100
13401	#8	19/64"	.040	100
13402	#10 (3/16")	21/64"	.047	100
13403	1/4"	31/64"	.062	100
13404	5/16"	19/32"	.078	100
13405	3/8"	11/16"	.094	100
13406	1/2"	7/8"	.125	50

Stainless Steel Hex Nuts



Auveco Part No.	Size	Hex Width	Thick-ness	Unit Pkg.
13234	1/4-20	7/16"	7/32"	100
13235	5/16-18	1/2"	17/64"	50
13236	3/8-16	9/16"	21/64"	50
13237	1/2-13	3/4"	7/16"	25

Stainless Steel Flat Washers



Auveco Part No.	Bolt Size	I.D.	O.D.	Thick-ness	Unit Pkg.
13392	#6 (1/8")	9/64"	3/8"	.030	100
13393	#8	5/32"	3/8"	.030	100
13394	#10 (3/16")	7/32"	7/16"	.030	100
13395	1/4"	9/32"	5/8"	.043	100
13396	5/16"	11/32"	3/4"	.050	100
13397	3/8"	13/32"	7/8"	.060	50
13398	1/2"	33/64"	1-1/4"	.060	50

BUMPER BOLTS

Listed According To Size

Zinc Plated



Auveco Part No.	Size	Head Style	Head Diameter	Unit Pkg.
Round Polished Stainless Steel Capped Heads				
5714*	5/16-18x 7/8"	Round	11/16"	Without Nuts 25
5238	3/8-16x 7/8"	Round	27/32"	Without Nuts 25
3414	3/8-16x 7/8"	Round	27/32"	With Hex Nuts 25
3432	3/8-16x 7/8"	Round	27/32"	With Lock Nuts 25
5239	3/8-16x 1"	Round	27/32"	Without Nuts 25
3415	3/8-16x 1"	Round	27/32"	With Hex Nuts 25
3433	3/8-16x 1"	Round	27/32"	With Lock Nuts 25
5240	3/8-16x 1-1/4"	Round	27/32"	Without Nuts 25
3820	3/8-16x 1-1/4"	Round	27/32"	With Hex Nuts 25
3821	3/8-16x 1-1/4"	Round	27/32"	With Lock Nuts 25
5241	3/8-16x 1-1/2"	Round	27/32"	Without Nuts 25
3822	3/8-16x 1-1/2"	Round	27/32"	With Hex Nuts 25
3823	3/8-16x 1-1/2"	Round	27/32"	With Lock Nuts 25
8626	7/16-14x 7/8"	Round	31/32"	Without Nuts 25
8627	7/16-14x 7/8"	Round	31/32"	With Hex Nuts 25
8552	7/16-14x 1"	Round	31/32"	Without Nuts 25
8557	7/16-14x 1"	Round	31/32"	With Hex Nuts 25
8562	7/16-14x 1"	Round	31/32"	With Lock Nuts 25
5242	7/16-14x 1-1/4"	Round	31/32"	Without Nuts 25
3099	7/16-14x 1-1/4"	Round	31/32"	With Hex Nuts 10
3434	7/16-14x 1-1/4"	Round	31/32"	With Lock Nuts 25
5243	7/16-14x 1-1/2"	Round	31/32"	Without Nuts 25
3100	7/16-14x 1-1/2"	Round	31/32"	With Hex Nuts 10
3435	7/16-14x 1-1/2"	Round	31/32"	With Lock Nuts 25
5246	1/2-13x 1-1/2"	Round	1-3/32"	Without Nuts 25
3102	1/2-13x 1-1/2"	Round	1-3/32"	With Hex Nuts 10
3438	1/2-13x 1-1/2"	Round	1-3/32"	With Lock Nuts 25

* Not Stainless Steel Cap - Chrome Plated

Sec. 3

BUMPER BOLTS
(ILLUSTRATIONS ACTUAL SIZE)



15545
Zinc

1/4"-20 x 3/4"
Stainless Steel Cap
w/o Nuts
Head Diameter: 5/8"
Shoulder Length: 9/64"

UNIT PACKAGE: 25



9853
(376337-S100)
Zinc

5/16"-18 x 3/4"
Stainless Steel Cap
w/o Nuts
Head Diameter: 3/4"
Shoulder Length: 3/16"
Ford

UNIT PACKAGE: 25

9854

Same as 9853 except with Hex Nuts

UNIT PACKAGE: 25

9855

Same as 9853 except with Lock Nuts

UNIT PACKAGE: 25



16985
Zinc

5/16"-18 x 1"
Stainless Steel Cap
w/o Nuts
Head Diameter: 3/4"
Shoulder Length: 3/16"

UNIT PACKAGE: 25



11614
(9433489)
Zinc

3/8"-16 x 1"
Stainless Steel Capped
Pan Head
w/o Nuts
Head Diameter: 7/8"
Shoulder Length: 3/32"
GM

UNIT PACKAGE: 25

11615

Same as 11614 except
with Hex Nuts

UNIT PACKAGE: 25



10655
(6026723)
Zinc

3/8"-16 x 1"
Stainless Steel Capped
Pan Head
w/o Nuts
Head Dia: 7/8"
Shoulder Length: 3/32"
Chrysler

UNIT PACKAGE: 25

10656

Same as 10655 except
with Hex Nuts

UNIT PACKAGE: 25

10657

Same as 10655 except
with Lock Nuts

UNIT PACKAGE: 25



16544

Zinc & Yellow

3/8"-16 x 1-1/4"
Stainless Steel Capped
Pan Head
w/o Nuts
Head Diameter: 7/8"
Shoulder Length: 1/8"

UNIT PACKAGE: 10



8623
Zinc

7/16"-14 x 1"
Stainless Steel Capped Pan Head
w/o Nuts
Head Diameter: 29/32"
Shoulder Length: 5/32"
GM

UNIT PACKAGE: 25

8624

Same as 8623 except with Hex Nuts

UNIT PACKAGE: 25

8625

Same as 8623 except
with Lock Nuts

UNIT PACKAGE: 25

BUMPER BOLTS
(ILLUSTRATIONS ACTUAL SIZE)



9354
(9786454)
Zinc

7/16"-14 x 1-3/8"
Stainless Steel Capped
Pan Head
w/o Nuts
Head Diameter: 29/32"
Shoulder Length: 5/32"
GM

UNIT PACKAGE: 25

9355

Same as 9354 except with Hex Nuts

UNIT PACKAGE: 25

9356

Same as 9354 except with Lock Nuts

UNIT PACKAGE: 25



10068
(9795883)
Zinc

7/16"-14 x 1-1/4"
Uncapped Round Head
w/o Nuts
Head Diameter: 15/16"
Shoulder Length: 7/32"
GM

UNIT PACKAGE: 25



11770
(490067)
Zinc

7/16"-14 x 1-1/2"
Uncapped Round Head
w/o Nuts
Head Diameter: 15/16"
Shoulder Length: 3/16"
GM

UNIT PACKAGE: 25

11771

Same as 11770 except
with Hex Nuts

UNIT PACKAGE: 25



16986
(14003784)
Zinc

M8-1.25 x 25mm
Stainless Steel Capped
Pan Head
w/o Nuts
Head Diameter: 19mm
Shoulder Length: 3mm
GM

UNIT PACKAGE: 25



15310
(11503687)
Phosphate

M8-1.25 x 30mm
Uncapped Round Head
w/o Nuts
Head Diameter: 17.5mm
Shoulder Length: 3mm
GM

UNIT PACKAGE: 25



10078
(6026724)
Zinc

1/2"-13 x 1-3/8"
Stainless Steel Capped Pan Head
w/o Nuts
Head Diameter: 1-7/64"
Shoulder Length: 3/32"
Chrysler

UNIT PACKAGE: 25

10079

Same as 10078 except w/ Hex Nuts

UNIT PACKAGE: 25

10083

Same as 10078 except w/ Lock Nuts

UNIT PACKAGE: 25

**You Can
Email Your
New Item
Suggestions To
mail@auveco.com**

**Please Order
In Unit Package
Quantities
Not Number Of
Pieces**

Sec. 3



Body Bolt Specification Chart



Auveco Part No.	Size	Length	Hex Size	Washer/ Head O.D.	Type	Point Type	Finish	Unit Pkg.	Page No.
2209	#8-32	5/16"		11/32"	Phillips Truss Head	C	Chrome	100	21
2753	1/4"-20	5/8"	3/8"	5/8"	Hex Washer Head Spin Lock	C	Blk Phos	100	8
10823	1/4"-20	7/8"	7/16"	3/4"	Hex Head Sems®	Dog Pt.	Blk Phos	50	21
13231	1/4"-20	7/8"	3/8"	5/8"	Hex Washer Head with Sems® Nylon Washer	CA	Phosphate Organic	25	21
13232	1/4"-20	7/8"	3/8"	5/8"	Hex Washer Head with Sems® Nylon Washer & Jack Nut®	CA	Phosphate Organic	25	21 Sets
17034	1/4"-20	7/8"	7/16"	3/4"	Hex Head Sems®	Dog Point	Zinc & Yellow Dichromate	50	21
15510	1/4"-20	1"	3/8"	1/2"	Hex Washer Head	C	Zinc	50	21
9757	1/4"-20	1"	3/8"	1"	Hex Head Sems®	C	Phosphate	100	21
9480	1/4"-20	1"	7/16"	5/8"	Hex Head Sems®	Dog Pt.	Phosphate	50	21
14976	1/4"-20	1-1/4"	3/8"	5/8"	Hex Washer Head with Nylon Washer	CA	Stainless Steel Bright Plated	25	21
14977	1/4"-20	1-1/4"	3/8"	5/8"	Hex Washer Head with Nylon Washer & Jack Nut®	CA	Stainless Steel Bright Plated	10	21 Sets
2688	5/16"-24	1"	1/2"	13/16"	Hex Washer Head Spin Lock	Dog Pt.	Black Phos.	50	8
10084	5/16"-18	3/4"	1/2"	21/32"	Hex Washer Head	CA	Blk Phos	100	21
3615	5/16"-18	3/4"	1/2"	13/16"	Hex Washer Head Spin Lock	Dog Pt.	Blk Phos	100	8
10362	5/16"-18	13/16"	1/2"	41/64"	Hex Washer Head	CA	Blk Phos	50	21
15792	5/16"-18	7/8"	1/2"	3/4"	Hex Head Sems®	CA	Phos. Organic	50	21
15783	5/16"-18	7/8"	1/2"	3/4"	Hex Head Sems®	CA	Phosphate	50	22
5711	5/16"-18	1"	1/2"	13/16"	Hex Washer Head Spin Lock	Dog Pt.	Blk Phos	50	8
9756	5/16"-18	1"	1/2"	7/8"	Hex Head Sems®	C	Phosphate	100	22
11320	5/16"-18	1"	1/2"	7/8"	Hex Head Sems®	CA	Phosphate	25	22
17035	5/16"-18	1-1/16"	1/2"	7/8"	Hex Head Sems®	Dog Pt.	Zinc & Yellow Dichromate	25	22
5713	5/16"-18	1-1/4"	1/2"	13/16"	Hex Washer Head Spin Lock	Dog Pt.	Blk Phos	50	8
8847	5/16"-18	1-1/4"	1/2"	7/8"	Hex Head Sems®	Dog Pt.	Blk Phos	50	22
11061	5/16"-18	1-1/4"	1/2"	21/32"	Hex Washer Head	Pinch	Plain	50	22
12009	5/16"-18	1-1/2"	1/2"	21/32"	Hex Washer Head	CA	Phos & Oil	50	22
10296	3/8"-16	1"	9/16"	3/4"	Hex Washer Head Spin Lock	C	Blk Phos	50	8
11109	3/8"-16	1"	9/16"	1"	Hex Head Sems®	CA	Phosphate	25	22
11110	3/8"-16	1-1/2"	9/16"	1-1/8"	Hex Head Sems®	CA	Phosphate	25	22
16739	3/8"-16	1-7/8"	9/16"	3/4"	Hex Washer Head	C	Zinc	5	22

METRIC BODY BOLT CHART APPEARS ON PAGES 49-50

BODY BOLTS

Sec. 3



2209
Chrome

#8-32 x 5/16"
Phillips Truss Head
UNIT PACKAGE: 100



10823

Black Phosphate

1/4"-20 x 7/8"
Hex Head Sems®
with Dog Point
3/4" Washer O.D.
7/16" Hex

UNIT PACKAGE: 50



17034

(57030-S36)
Zinc & Yellow
Dichromate

1/4"-20 x 7/8"
Hex Head Sems®
With Dog Point
3/4" Washer O.D.
7/16" Hex
Ford

UNIT PACKAGE: 50



13231

(14007510)
Phos. Organic

1/4"-20 x 7/8"
Hex Washer Head
w/ Sems® Nylon Washer
5/8" Washer O.D.
3/8" Hex
Truck Mirror
Mounting Screw
GM

UNIT PACKAGE: 25



13232

(14007510,
367292)

Phos. Organic Screw
Zinc w/Sealer Jack Nut

1/4"-20 x 7/8"
Hex Washer Head
w/ Sems® Nylon Washer
5/8" Washer O.D.
3/8" Hex
Truck Mirror Mounting Screw
& Jack Nut
GM, Chrysler

UNIT PACKAGE: 25 Sets



9480

(6025329)
Phosphate

1/4"-20 x 1"
Hex Head Sems®
with Dog Point
5/8" Washer O.D.
7/16" Hex
Chrysler

UNIT PACKAGE: 50



9757

Phosphate

1/4"-20 x 1"
Hex Head Sems®
1" Washer O.D.
3/8" Hex
GM, Ford

UNIT PACKAGE: 100



15510

Zinc

1/4"-20 x 1"
Hex Washer Head
1/2" Washer Head O.D.
3/8" Hex

UNIT PACKAGE: 50



14976

(367291, 474821, 14007511)
400 Series Stainless Steel
Bright Plated

1/4"-20 x 1-1/4"
Hex Washer Head
With Nylon Washer
5/8" Washer O.D.
3/8" Hex
Truck Mirror Mounting Screw
GM, Chrysler

UNIT PACKAGE: 25



14977

(367291, 367292,
474821, 14007511)
400 Series Stainless
Steel - Bright Plated
Zinc w/Sealer
Jack Nut

1/4"-20 x 1-1/4"
Hex Washer Head
With Nylon Washer
5/8" Washer O.D.
3/8" Hex
Truck Mirror Mounting
Screw & Jack Nut
GM, Chrysler

UNIT PACKAGE: 10 Sets



10084

Black Phosphate

5/16"-18 x 3/4"
Hex Washer Head
21/32" Washer Head O.D.
1/2" Hex
GM

UNIT PACKAGE: 100



10362

Black Phosphate

5/16"-18 x 13/16"
Hex Washer Head
41/64" Washer Head O.D.
1/2" Hex
GM

UNIT PACKAGE: 50



15792

(15598757, 15686047)
Phosphate Organic

5/16"-18 x 7/8"
Indented Hex Head Sems®
3/4" Washer O.D.
1/2" Hex
GM

UNIT PACKAGE: 50



15783
(3846202)
Phosphate

5/16"-18 x 7/8"
Indented Hex Head Sems®
3/4" Washer O.D.
1/2" Hex
GM

UNIT PACKAGE: 50



9756
Phosphate

5/16"-18 x 1"
Hex Head Sems®
7/8" Washer O.D.
1/2" Hex
GM, Ford

UNIT PACKAGE: 100



11320
Phosphate

5/16"-18 x 1"
Hex Head Sems®
7/8" Washer O.D.
1/2" Hex
GM, Ford

UNIT PACKAGE: 25



17035
(384931-S36)
Zinc & Yellow Dichromate

5/16"-18 x 1-1/16"
Hex Hd. Sems® with Dog Pt.
7/8" Washer O.D.
1/2" Hex
Ford

UNIT PACKAGE: 25



8847
(380575-S2)
Black
Phosphate

5/16"-18 x 1-1/4"
Hex Head Sems® With Dog Point
7/8" Washer O.D.
1/2" Hex
Ford

UNIT PACKAGE: 50



11061
Plain

5/16"-18 x 1-1/4"
Hex Washer Head
With Pinch Point
21/32" Washer Head O.D.
1/2" Hex
Grade 5

UNIT PACKAGE: 50



12009
Phosphate & Oil

5/16"-18 x 1-1/2"
Hex Washer Head
21/32" Washer Head O.D.
1/2" Hex
GM

UNIT PACKAGE: 50



11109
(3986997,
14011722)
Phosphate

3/8"-16 x 1"
Hex Head Sems®
1" Washer O.D.
9/16" Hex
GM

UNIT PACKAGE: 25



11110
(407217, 1564180)
Phosphate

3/8"-16 x 1-1/2"
Hex Head Sems®
1-1/8" Washer O.D.
9/16" Hex
Hood Hinge To Sheet Metal Bolt
GM

UNIT PACKAGE: 25



16739
(1366042)
Zinc

3/8"-16 x 1-7/8"
Hex Washer Head
3/4" Washer Head O.D.
9/16" Hex
Starter Bolt
Grade 5
GM

UNIT PACKAGE: 5

Special Tapping Screw Specification Chart



Auveco Part No.	Size	Length	Hex Size	Washer/ Head O.D.	Type	Point Type	Finish	Unit Pkg.	Page No.
9877	#4-24	3/8"		7/32"	Phillips Flat Head	AB	Zinc	100	26
10642	#8	3/8"		3/8"	Phillips Oval Washer Head	AB	Zinc	100	26
16997	#8	3/8"		3/8"	Phillips Oval Washer Head	AB	Black E-Coat	100	26
9863	#8	3/8"		9/32"	Phillips Round Washer Head	AB	Zinc	100	26
13707	#8	3/8"		13/32"	Phillips Flat Top Washer Head	AB	Zinc	100	26
8944	#8	3/8"		7/16"	Phillips Washer Head	AB	Chrome	100	26
12062	M4.2 (#8)	10mm (13/32")		11mm (7/16")	Phillips Washer Head, Pozi-Drive	AB	Black Oxide	100	26
2805	#8	7/16"		3/8"	Phillips Washer Head	AB	Zinc	100	26
15037	#8	7/16"		5/16"	Phillips Washer Head	AB	Chrome	100	27
9229	#8	7/16"		9/32"	Phillips Washer Head, Pozi-Drive	AB	Zinc	100	27
1826	#8	7/16"		13/32"	Phillips Truss Head	AB	Chrome	100	27
15941	M4.2 (#8)	12mm (15/32")		9.5mm (3/8")	Phillips Truss Head	AB	Black Oxide	10	27
16596	M4.2 (#8)	12mm (15/32")		9.5mm (3/8")	Phillips Truss Head	AB	Black Oxide	100	27
12739	M4.2 (#8)	12mm (15/32")		10mm (25/64")	Phillips Washer Head, Pozi-Drive	AB	Chrome	100	27
13708	#8	1/2"		13/32"	Phillips Flat Top Washer Head	AB	Zinc	100	27
12213	#8	1/2"		13/32"	Phillips Flat Top Washer Head	AB	Black E-Coat	100	27
13025	#8	1/2"		31/64"	Phillips Washer Head	AB	Phosphate	100	27
20375	#8	1/2"		1/2"	Phillips Round Washer Head	AB	Black Phos	100	27
15172	#8	1/2"		13/32"	Phillips Washer Head	Teks®	Zinc	100	27
15171	#8	1/2"		23/64"	Phillips Low Profile Round Wash Head	Teks®	Zinc	100	27
12095	#8	1/2"		7/16"	Phillips Washer Head	Teks®	Zinc	50	27
15774	#8	1/2"		7/16"	Phillips Washer Head	Teks®	Black Phosphate	50	27
16478	#8	1/2"		13/32"	Phillips Flat Top Round Washer Head	Teks®	Black Zinc	100	27
12059	M4.2 (#8)	13mm (33/64")		11mm (7/16")	Phillips Washer Head	AB	Zinc	100	27
12061	M4.2 (#8)	13mm (33/64")		8.5mm (11/32")	Phillips Round Washer Head, Pozi-Drive	AB	Black Oxide	100	27
13712	M4.2 (#8)	13mm (33/64")		11mm (7/16")	Phillips Washer Head	AB	Black Zinc	50	28
12740	M4.2 (#8)	13mm (33/64")	7mm	12mm (15/32")	Hex Head Sems®	AB	Phosphate	100	28
12743	M4.2 (#8)	13mm (33/64")	7mm	9mm (11/32")	Hex Washer Head	AB	Zinc	100	28
15721	M4.2 (#8)	13mm (33/64")	7mm	16mm (5/8")	Hex Head Sems®	AB	Phosphate	50	28
18781	M4.2 (#8)	14mm (9/16")	7mm	8mm (5/16")	Hex Head Sems®	AB	Phosphate	50	28
21122	M4.2 (#8)	14mm (9/16")		11mm (7/16")	Phillips Washer Head, Pozi-Drive	Teks®	Chrome	50	28

(Continued on Next Page)

Sec. 4

Special Tapping Screw Specification Chart



Auveco Part No.	Size	Length	Hex Size	Washer/ Head O.D.	Type	Point Type	Finish	Unit Pkg.	Page No.
2806	#8	5/8"		13/32"	Phillips Round Washer Head	AB	Chrome	100	28
13711	#8	5/8"		31/64"	Phillips Washer Head	AB	Phosphate	100	28
18817	M4.2 (#8)	16mm (5/8")		11mm (7/16")	Phillips Round Washer Head, Pozi-Drive	Teks®	Black Zinc	100	28
16720	M4.2 (#8)	16mm (5/8")		9.5mm (3/8")	Phillips Truss Head	AB	Black Oxide	100	28
12741	M4.2 (#8)	16mm (5/8")	7mm	12mm (15/32")	Hex Head Sems®	AB	Phosphate	100	28
18261	M4.2 (#8)	16mm (5/8")	7mm	12mm (15/32")	Hex Washer Head Sems®	Teks®	Phosphate	50	28
13687	#8	3/4"		9/32"	Phillips Washer Head	AB	Zinc	100	28
13026	#8	3/4"		31/64"	Phillips Washer Head	AB	Phosphate	100	28
17460	#8	3/4"		7/16"	Phillips Round Washer Head	Teks®	Zinc	50	28
17650	#8	3/4"		7/16"	Phillips Round Washer Head	Teks®	Phosphate	50	28
16531	#8	3/4"		9/32"	Phillips Flat Top, with Sealer	AB	Decorative Blk.	50	29
16534	#8	3/4"		5/16"	Phillips Pan Head, with Sealer	Teks®	Black Zinc	50	29
12060	M4.2 (#8)	20mm (25/32")		11mm (7/16")	Phillips Washer Head	AB	Black Oxide	100	29
12097	M4.2 (#8)	20mm (25/32")		12mm (15/32")	Phillips Pan Head Sems®	AB	Chrome	50	29
12738	M4.2 (#8)	20mm (25/32")	7mm	12mm (15/32")	Hex Washer Head Sems®	AB	Phosphate	50	29
12742	M4.2 (#8)	20mm (25/32")	7mm	12mm (15/32")	Hex Head Sems®	AB	Phosphate	100	29
15373	M4.2 (#8)	20mm (25/32")	7mm	16mm (5/8")	Hex Head Sems®	AB	Phosphate	50	29
20271	M4.2 (#8)	20mm (25/32")		16mm (5/8")	Phillips Pan Head Sems®	AB	Phosphate	50	29
20476	M4.2 (#8)	20mm (25/32")	7mm	17mm (11/16")	Hex Washer Head Sems®	Teks®	Phosphate	50	29
19278	M4.2 (#8)	20mm (25/32")	7mm	20mm (25/32")	Hex Head Sems®	AB	Black Phos.	50	29
15775	M4.2 (#8)	20mm (25/32")	7mm	12mm (15/32")	Hex Head Sems®	Teks®	Phosphate	50	29
18296	#8	1"		7/16"	Phillips Round Washer Head	Teks®	Zinc	50	29
19006	M4.2 (#8)	25mm (1")		11mm (7/16")	Round Washer Head, Pozi-Drive	Teks®	Phosphate	100	29
20382	M4.2 (#8)	25mm (1")	T-15 Drive	12mm (15/32")	Torx® Pan Head Sems®	AB	Black Zinc	50	29
20376	#8	1"		1/2"	Phillips Round Washer Head	AB	Black Phos.	100	29
18336	M4.2 (#8)	25mm (1")	7mm	12mm (15/32")	Hex Head Sems®	AB	Black Phos.	100	29
19653	M4.2 (#8)	30mm (1-3/16")	7mm	17mm (11/16")	Hex Head Sems®	AB	Black Phos.	15	30
18460	#8	1-1/4"		3/8"	Phillips Oval Head Sems® Flush Washer	Teks®	Phosphate	50	30
19778	#8	1-1/4"		7/16"	Phillips Round Washer Head	Teks®	Zinc	50	30

Special Tapping Screw Specification Chart



Auveco Part No.	Size	Length	Hex Size	Washer/ Head O.D.	Type	Point Type	Finish	Unit Pkg.	Page No.
2178	#10	3/8"		31/64"	Phillips Round Washer Head	AB	Zinc	100	30
2028	#10	1/2"		11/32"	Phillips Round Head	AB	Zinc	100	30
13027	#10	1/2"		15/32"	Phillips Flat Washer Head	AB	Zinc	100	30
15827	#10	1/2"		15/32"	Phillips Flat Washer Head	AB	Phosphate	100	30
18340	M4.8 (#10)	15mm (19/32")		14mm (9/16")	Phillips Truss Head	AB	Black Phos.	50	30
20364	#10	5/8"		7/16"	Phillips Washer Head	Teks®	Zinc	100	30
17459	M4.8 (#10)	16mm (5/8")		11mm (7/16")	Phillips Truss Head	AB	Black Oxide	100	30
20259	M4.8 (#10)	19mm (3/4")		16mm (5/8")	Phillips Truss Head Sems®	AB	Black E Coat	25	30
13709	#10	3/4"		15/32"	Phillips Flat Top Washer Head	AB	Zinc	50	30
19240	#10	3/4"		1/2"	Phillips Flat Top Round Washer Head	AB	Black E-Coat	100	30
16589	M4.8 (#10)	19mm (3/4")	8mm	15mm (19/32")	Hex Head Sems®	AB	Zinc & Yellow Dichromate	50	30
20455	M4.8 (#10)	20mm (25/32")		14mm (9/16")	Phillips Truss Head	AB	Black Phos.	50	30
19237	#10	1-1/32"		9/16"	Nylon Phillips Pan Head	AB	Black Nylon	50	30
19517	#10	2-1/16"		9/16"	Nylon Phillips Truss Head	AB	Black Nylon	25	31
17461	M5.5 (#12)	18mm (45/64")	8mm	15mm (19/32")	Hex Head Sems®	AB	Zinc & Yellow Dichromate	50	31
21541	M5.5 (#12)	20mm (25/32")	T-20 Drive	15mm (19/32")	Torx® Truss Head	AB	Black Zinc	25	31
12318	M6.3 (#14)	13mm (33/64")	10mm	12mm (15/32")	Hex Washer Head	AB	Zinc	50	31
19718	M6.3 (#14)	16mm (5/8")	T-30 Drive	13mm (1/2")	Torx® Oval Head	AB	Mechanical Zinc & Yellow Chromate	50	31
19170	M6.3 (#14)	16mm (5/8")		15mm (19/32")	Phillips Truss Head	AB	Black Phos.	50	31
15776	M6.3 (#14)	16mm (5/8")	8mm	16mm (5/8")	Hex Head Sems®	AB	Phosphate	50	31
12057	M6.3 (#14)	16mm (5/8")	10mm	17mm (11/16")	Hex Head Sems®	AB	Phosphate	50	31
15962	M6.3 (#14)	18mm (23/32")	10mm	22mm (7/8")	Hex Head Sems®	AB	Zinc & Yellow Dichromate	25	31
13021	#14	3/4"	3/8"	1/2"	Hex Washer Head	AB	Phosphate	50	31
13019	M6.3 (#14)	19mm (3/4")	8mm	11.5mm (29/64")	Hex Washer Head	AB	Phosphate	50	31
20556	M6.3 (#14)	20mm (25/32")	10mm	16mm (5/8")	Phillips Hex Head Sems®	AB	Black Zinc	50	31
12351	M6.3 (#14)	20mm (25/32")	10mm	17mm (11/16")	Hex Washer Head Sems®	AB	Black Polyseal	50	31









(Continued on Next Page)

Sec. 4

Special Tapping Screw Specification Chart



Auveco Part No.	Size	Length	Hex Size	Washer/ Head O.D.	Type	Point Type	Finish	Unit Pkg.	Page No.
16828	M6.3 (#14)	20mm (25/32")	10mm	18mm (45/64")	Hex Head Sems®	AB	Zinc & Yellow Dichromate	25	32
20557	M6.3 (#14)	20mm (25/32")	10mm	20mm (25/32")	Phillips Hex Head Sems®	AB	Black Zinc	50	32
18934	#14	7/8"	3/8"	13/16"	Hex Washer Head	AB	Zinc Organic	25	32
12339	M6.3 (#14)	25mm (1")	10mm	17mm (11/16")	Hex Head Sems®	AB	Phosphate	50	32
12354	M6.3 (#14)	30mm (1-3/16")	10mm	17mm (11/16")	Hex Head Sems®	AB	Phosphate	50	32
12068	M6.3 (#14)	30mm (1-3/16")	10mm	24mm (15/16")	Hex Head Sems®	AB	Phosphate	50	32
19417	M7.5	35mm (1-3/8")	#3 Sq. Drive	22mm (7/8")	Nylon Square Drive Truss Head	AB	Black Nylon	15	32
12350	M8 (5/16"-12)	20mm (25/32")	13mm	16mm (5/8")	Hex Washer Head	AB	Phosphate	25	32
10364	5/16"-12	7/8"	1/2"	21/32"	Hex Washer Head	AB	Black Oxide	100	32
10714	5/16"-12	1"	1/2"	21/32"	Hex Washer Head	AB	Phosphate	50	32
21517	M9.5	46mm (1-13/16")	#3 Sq. Drive	22mm (7/8")	Nylon Square Drive Truss Head	AB	Black Nylon	25	32
20970	M14	34mm (1-11/32")	#3 Sq. Drive	22mm (7/8")	Nylon Square Drive Truss Head	AB	Black Nylon	25	32

 <p>9877 Zinc #4-24 x 3/8" Special Phillips Flat Head 7/32" Head Diameter Use To Replace Welded Studs For Moulding Clips UNIT PACKAGE: 100</p>	 <p>16997 Same As 10642 With Black E-Coat (168 Hours Salt Spray) #8 x 3/8" Phillips Oval Washer Head 3/8" Washer Head O.D. Wheel Opening Mouldings UNIT PACKAGE: 100</p>	 <p>13707 (9422246) Zinc #8 x 3/8" Phillips Flat Top Wshr Hd 13/32" Washer Head O.D. Chrysler UNIT PACKAGE: 100</p>	 <p>12062 (11501903) Black Oxide M4.2-1.41 x 10mm (#8 x 13/32") Phillips Washer Head Pozi-Drive 11mm (7/16") Washer Hd. O.D. GM UNIT PACKAGE: 100</p>
 <p>10642 (381671-S) Zinc #8 x 3/8" Phillips Oval Washer Head 3/8" Washer Head O.D. Wheel Opening Mouldings Ford UNIT PACKAGE: 100</p>	 <p>9863 Zinc #8-18 x 3/8" Phillips Round Washer Head 9/32" Head Dia. Chrysler UNIT PACKAGE: 100</p>	 <p>8944 Chrome #8-18 x 3/8" Phillips Washer Head 7/16" Washer Head O.D. For Attaching Chrome Floor Strips Ford UNIT PACKAGE: 100</p>	 <p>2805 Zinc #8 x 7/16" Phillips Washer Head 3/8" Washer Head O.D. UNIT PACKAGE: 100</p>

Special Tapping Screws

Sec. 4

 <p>15037 (588546) Chrome</p> <p>#8 x 7/16" Phillips Washer Head 410 Stainless Steel 5/16" Washer Head O.D. Wheel Mouldings GM</p> <p>UNIT PACKAGE: 100</p>	 <p>12739 (11501794) Chrome</p> <p>M4.2-1.41 x 12mm (#8 x 15/32") Phillips Washer Head Pozi-Drive 10mm (25/64") Washer Head O.D. GM</p> <p>UNIT PACKAGE: 100</p>	 <p>20375 Black Phosphate</p> <p>#8 x 1/2" Phillips Round Washer Head 1/2" Head Diameter</p> <p>UNIT PACKAGE: 100</p>	 <p>15774 (GM: 20423550) (Ford: 381801-S2, 390017-S2) Black Phosphate</p> <p>#8 x 1/2" Phillips Washer Head With Tek's® Point 7/16" Washer Head O.D. GM & Ford</p> <p>UNIT PACKAGE: 50</p>
 <p>9229 (4879431) Zinc</p> <p>#8-18 x 7/16" Phillips Washer Head Pozi-Drive 9/32" Washer Head O.D. Wheel Mouldings GM</p> <p>UNIT PACKAGE: 100</p>	 <p>13708 (9422202) Zinc</p> <p>#8 x 1/2" Phillips Flat Top Wshr Hd 13/32" Washer Head O.D. Chrysler</p> <p>UNIT PACKAGE: 100</p>	 <p>15172 Zinc</p> <p>#8 x 1/2" Phillips Washer Head With #2 Tek's® Point 13/32" Washer Head O.D.</p> <p>UNIT PACKAGE: 100</p>	 <p>16478 (153297) Black Zinc</p> <p>#8-18 x 1/2" Phillips Flat Top Round Washer Head Tek's® 13/32" Washer Head O.D. Chrysler</p> <p>UNIT PACKAGE: 100</p>
 <p>1826 Chrome</p> <p>#8 x 7/16" Phillips Truss Head 13/32" Head Diameter</p> <p>UNIT PACKAGE: 100</p>	 <p>12213 (11503421, 11503636) Black E-Coat</p> <p>#8-18 x 1/2" Phillips Flat Washer Head 13/32" Washer Head O.D. GM</p> <p>UNIT PACKAGE: 100</p>	 <p>15171 Zinc</p> <p>#8 x 1/2" Phillips Low Profile Round Washer Head With #2 Tek's® Point 23/64" Washer Head O.D.</p> <p>UNIT PACKAGE: 100</p>	 <p>12059 (11501883) Zinc</p> <p>M4.2-1.41 x 13mm (#8 x 33/64") Phillips Washer Head Pozi-Drive 11mm (7/16") Washer Head O.D. GM</p> <p>UNIT PACKAGE: 100</p>
 <p>15941 Black Oxide</p> <p>M4.2-1.41 x 12mm (#8 x 15/32") Phillips Truss Head 9.5mm (3/8") Head Diameter Japanese Imports</p> <p>UNIT PACKAGE: 10</p> <p>16596</p> <p>Same As 15941 Except For Unit Package</p> <p>UNIT PACKAGE: 100</p>	 <p>13025 (56910-S2) Phosphate</p> <p>#8 x 1/2" Phillips Washer Head 31/64" Washer Head O.D. Ford</p> <p>UNIT PACKAGE: 100</p>	 <p>12095 (1689827) Zinc</p> <p>#8 x 1/2" Phillips Washer Head with Tek's® Point 7/16" Washer Head O.D. Reveal Moulding To Panel GM</p> <p>UNIT PACKAGE: 50</p>	 <p>12061 (11501896) Black Oxide</p> <p>M4.2-1.41 x 13mm (#8 x 33/64") Phillips Round Washer Head Pozi-Drive 8.5mm (11/32") Washer Hd. O.D. GM</p> <p>UNIT PACKAGE: 100</p>

Sec. 4

SPECIAL TAPPING SCREWS



13712
(11505104)
Black Zinc

M4.2-1.41 x 13mm
(#8 x 33/64")
Phillips Washer Head
11mm (7/16")
Washer Hd. O.D.
GM

UNIT PACKAGE: 50



21122
Chrome

M4.2-1.41 x 14mm
(#8 x 9/16")
Phillips Pozzi Drive
Washer Head Teks®
11mm (7/16")
Washer Head O.D.

UNIT PACKAGE: 50



18817
(1746408)
Black Zinc

M4.2-1.41 x 16mm
(#8 x 41/64")
Phillips Round Washer Hd
w/Serrations Under The Hd
Pozzi-Drive With Teks® Point
11mm (7/16") Wshr Hd O.D.
Moulding, Trim & General
Purpose
GM

UNIT PACKAGE: 100



13687
Zinc

#8 x 3/4"
Phillips Washer Hd
9/32" Washer Head O.D.

UNIT PACKAGE: 100



12740
(11503394)
Phosphate

M4.2-1.41 x 13mm
(#8 x 33/64")
Hex Head Sems®
12mm (15/32")
Washer O.D.
7mm Hex
GM

UNIT PACKAGE: 100



18781
(11515566)
Phosphate

M4.2-1.41 x 14mm
(#8 x 9/16")
Hex Head Sems®
8mm (5/16") Washer O.D.
7mm Hex
GM

UNIT PACKAGE: 50



16720
Black Oxide

M4.2-1.41 x 16mm
(#8 x 5/8")
Phillips Truss Head
9.5mm (3/8") Head O.D.
Honda

UNIT PACKAGE: 100



13026
(56912-S2)
Phosphate

#8 x 3/4"
Phillips Washer Head
31/64" Washer Head O.D.
Ford

UNIT PACKAGE: 100



12743
(11502843)
Zinc

M4.2-1.41 x 13mm
(#8 x 33/64")
Hex Washer Head
9mm (11/32") Washer O.D.
7mm Hex
GM

UNIT PACKAGE: 100



2806
Chrome

#8 x 5/8"
Phillips Round Washer Hd
13/32" Washer Head O.D.

UNIT PACKAGE: 100



12741
(11503395)
Phosphate

M4.2-1.41 x 16mm
(#8 x 5/8")
Hex Head Sems®
12mm (15/32") Wshr O.D.
7mm Hex
GM

UNIT PACKAGE: 100



17460
(382413-S9)
Zinc

#8 x 3/4"
Phillips Round Washer Hd
With Teks® Point
7/16" Washer Head O.D.
Door Scuff Plate
Ford

UNIT PACKAGE: 50



15721
(11504010)
Phosphate

M4.2-1.41 x 13mm
(#8 x 19/32")
Indented Hex Head Sems®
16mm (5/8") Washer O.D.
7mm Hex
GM

UNIT PACKAGE: 50



13711
(56911-S2, 56929-S2)
Phosphate

#8 x 5/8"
Phillips Washer Head
31/64" Washer Head O.D.
Ford

UNIT PACKAGE: 100



18261
(11503578,
11503785)
Phosphate

M4.2-1.41 x 16mm
(#8 x 5/8")
Hex Washer Head Sems®
With Teks® Point
12mm (1/2") Washer O.D.
7mm Hex
GM

UNIT PACKAGE: 50



17650
Phosphate

#8 x 3/4"
Phillips Round Washer Hd
With Teks® Point
7/16" Washer Hd. O.D.

UNIT PACKAGE: 50

SPECIAL TAPPING SCREWS

Sec. 4



16531
(154508)
Decorative Black

#8-15 x 3/4"
Phillips Flat Top
Self-Piercer; With Sealer
9/32" Head Diameter
Quarter Panel Side
Reflector
Chrysler

UNIT PACKAGE: 50



12738
(11504056, 11513801)
Phosphate

M4.2-1.41 x 20mm
(#8 x 25/32")
Hex Washer Head Sems®
12mm (1/2") Washer O.D.
7mm Hex
Radiator & Grille
GM

UNIT PACKAGE: 50



20476
Phosphate

M4.2-1.41 x 20mm
(#8 x 25/32")
Hex Washer Head
Sems® Teks®
17mm (11/16") Washer
O.D.
7mm Hex
General Purpose

UNIT PACKAGE: 50



19006
Phosphate

M4.2-1.41 x 25mm
(#8 x 1")
Round Washer Head
Pozi-Drive
With Teks® Point
11mm (7/16") Washer Hd.
O.D.
General Purpose

UNIT PACKAGE: 100



16534
(154534)
Black Zinc

#8-18 x 3/4"
Phillips Pan Head
With Teks® Point & Sealer
5/16" Head Diameter
Cargo Door Scuff Plate
Chrysler Full Size Van

UNIT PACKAGE: 50



12742
(11503396, 11503483)
Phosphate

M4.2-1.41 x 20mm
(#8 x 25/32")
Hex Head Sems®
12mm (1/2") Washer O.D.
7mm Hex
Front End & Air Cond.
GM

UNIT PACKAGE: 100



19278
(GM: 14090382;
Chrys: 6506161-AA)
Black Phosphate

M4.2-1.41 x 20mm
(#8 x 25/32")
Hex Head Sems®
20mm (25/32") Washer
O.D.
7mm Hex
GM

UNIT PACKAGE: 50



20382
(Not Available
From O.E.M.)
Black Zinc

M4.2-1.41 x 25mm
(#8 x 1")
Torx® Pan Head Sems®
T-15 Drive
12mm (1/2") Washer O.D.

UNIT PACKAGE: 50



12060
(11501884)
Black Oxide

M4.2-1.41 x 20mm
(#8 x 25/32")
Phillips Washer Head
11mm (7/16") Washer O.D.
GM

UNIT PACKAGE: 100



15373
(11503892,
11500434)
Phosphate

M4.2-1.41 x 20mm
(#8 x 25/32")
Hex Head Sems®
16mm (5/8") Washer O.D.
7mm Hex
GM

UNIT PACKAGE: 50



15775
Phosphate

M4.2-1.41 x 20mm
(#8 x 25/32")
Hex Head Sems®
With Teks® point
12mm (1/2") Washer O.D.
7mm Hex

UNIT PACKAGE: 50



20376
Black Phosphate

#8 x 1"
Phillips Round
Washer Head
1/2" Head Diameter

UNIT PACKAGE: 100



12097
(9420052, 11502483)
Chrome

M4.2-1.41 x 20mm
(#8 x 25/32")
Phillips Pan Head Sems®
Pozi-Drive
12mm (1/2") Washer O.D.
GM

UNIT PACKAGE: 50



20271
Phosphate

M4.2-1.41 x 20mm
(#8 x 25/32")
Phillips Pan Head Sems®
16mm (5/8") Washer O.D.
Ford

UNIT PACKAGE: 50

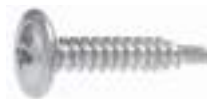

18296
Zinc

#8 x 1"
Phillips Round Washer Hd
With Teks® Point
7/16" Washer Head O.D.
General Purpose

UNIT PACKAGE: 50



18336
Black Phosphate

M4.2-1.41 x 25mm
(#8 x 1")
Hex Head Sems®
12mm (1/2") Washer O.D.
7mm Hex

UNIT PACKAGE: 100

Sec. 4

SPECIAL TAPPING SCREWS



19653
(N811534-S61)
Black Phosphate

M4.2-1.41 x 30mm
(#8 x 1-3/16")
Hex Head Sems®
17mm (11/16") Washer
O.D.
7mm Hex
Ford

UNIT PACKAGE: 15



18460
Phosphate

#8 x 1-1/4"
Phillips Oval Head
Sems® Flush Washer
With #2 Teks® Point
3/8" Washer O.D.
Interior Trim

UNIT PACKAGE: 50



19778
Zinc

#8 x 1-1/4"
Phillips Round
Washer Head
With Teks® Point
7/16" Washer Head O.D.
General Purpose

UNIT PACKAGE: 50



2178
Zinc

#10 x 3/8"
Phillips Round Wshr Hd
31/64" Washer Head O.D.

UNIT PACKAGE: 100



2028
Zinc

#10 x 1/2"
Phillips Round Head
11/32" Head Diameter

UNIT PACKAGE: 100



13027
(9428273)
Zinc

#10 x 1/2"
Phillips Flat Washer Head
15/32" Washer Head O.D.
Chrysler

UNIT PACKAGE: 100



15827
(9423950)
Phosphate

#10 x 1/2"
Phillips Flat Washer Head
15/32" Washer Head O.D.
Chrysler

UNIT PACKAGE: 100



18340
Black Phosphate

M4.8-1.6 x 15mm
(#10 x 19/32")
Phillips Truss Head
14mm (9/16") Head O.D.
Nissan Bumpers

UNIT PACKAGE: 50



20364
Zinc

#10 x 5/8"
Phillips Washer Head
With Teks® Point
Serrations Under The
Washer Head
7/16" Washer Head O.D.
GM

UNIT PACKAGE: 100



17459
Black Oxide

M4.8-1.61 x 16mm
(#10 x 5/8")
Phillips Truss Head
11mm (7/16") Head O.D.
Imports

UNIT PACKAGE: 100



20259
(90114-SZ3-000,
90114-SE0-000)
Black E-Coat

M4.8-1.61 x 19mm
(#10 x 3/4")
Phillips Truss Head Sems®
Washer O.D.: 16mm (5/8")
Splash Shield & General
Purpose
Honda 1986 - On

UNIT PACKAGE: 25



13709
(9427977)
Zinc

#10 x 3/4"
Phillips Flat Top
Washer Head
15/32" Washer Head O.D.
Chrysler

UNIT PACKAGE: 50

**Please Order In
Unit Package
Quantities
Not Number Of
Pieces**



19240
Black E-Coat

#10 x 3/4"
Phillips Flat Top
Round Washer Head
1/2" Washer Head O.D.
General Purpose

UNIT PACKAGE: 100



16589
Zinc &
Yellow Dichromate

#10 x 3/4" (19mm)
Indented Hex Head Sems®
Washer O.D.: 19/32"
5/16" (8mm) Hex
Honda, Nissan, Toyota

UNIT PACKAGE: 50



20455
Black Phosphate

M4.8-2.12 x 20mm
(#10 x 25/32")
Phillips Truss Head
14mm (9/16") Head O.D.
Imports

UNIT PACKAGE: 50



19237
(W701649-S,
W704881-S300)
Black Nylon

Cowl Top Vent Grille
Nylon Screw
#10 x 1-1/32"
9/16" Head O.D.
Use With Auveco 19238
Ford Taurus & Sable
1996-On

UNIT PACKAGE: 50

SPECIAL TAPPING SCREWS

Sec. 4



19517

(N811849-S300)
Black Nylon

Cowl Top
Vent Grille
Nylon Screw
#10 x 2-1/16"
9/16" Head O.D.
Ford Trucks
1998-On

UNIT PACKAGE: 25

**At Auveco
We Continually Strive
To Have The
Best Selection
Of Body Hardware
And Specialty
Fasteners.**

**Please Email Your
New Item
Suggestions
To:
mail@auveco.com**



17461

Zinc & Yellow Dichromate

M5.5-1.81 x 18mm
(#12 x 45/64")
Hex Head Sems®
15mm (19/32") Wshr O.D.
8mm Hex
Imports

UNIT PACKAGE: 50



21541

(13144822)
Black Zinc

M5.5 x 20mm (12 x 25/32")
Torx® Truss Head
T-20 Drive
15mm (19/32") Head O.D.
**Use With Auveco 21539 &
21540**

GM 2011 - On
Saab 2003 - On

UNIT PACKAGE: 25



19718

(6501220)
Mechanical Zinc
& Yellow Chromate

M6.3-1.81 x 16mm
(#14 x 5/8")
Torx® Drive Oval Head
T-30 Drive
13mm (1/2") Head O.D.
Door Latch Mounting
Chrysler
1986-On

UNIT PACKAGE: 50



19170

Black Phosphate

M6.3-1.81 x 16mm
(#14 x 5/8")
Phillips Truss Head
15mm (19/32") Head O.D.
Japanese Imports

UNIT PACKAGE: 50



15776

(N800312-S2)
Phosphate

M6.3-1.81 x 16mm
(#14 x 41/64")
Hex Head Sems®
16mm (5/8") Washer O.D.
8mm Hex; Ford

UNIT PACKAGE: 50



12057

(11500994,
11509371)
Phosphate

M6.3-1.81 x 16mm
(#14 x 41/64")
Hex Head Sems®
17mm (11/16") Wshr O.D.
10mm Hex
GM

UNIT PACKAGE: 50



15962

Zinc & Yellow Dichromate

M6.3-1.81 x 18mm
(#14 x 23/32")
Hex Head Sems®
22mm (7/8") Washer O.D.
10mm Hex
Honda, Nissan, Toyota

UNIT PACKAGE: 25



13021

(55914-S2)
Phosphate

#14 x 3/4"
Hex Washer Head
1/2" Washer Head O.D.
3/8" Hex
Ford

UNIT PACKAGE: 50



13019

(N610959-S2)
Phosphate

M6.3-1.81 x 19mm
(#14 x 3/4")
Hex Washer Head
11.5mm (29/64")
Washer Hd. O.D.
8mm Hex
Ford

UNIT PACKAGE: 50



20556

Black Zinc

M6.3-1.81 x 20mm
(#14 x 25/32")
Phillips Hex Head Sems®
16mm (5/8") Washer O.D.
10mm Hex
Imports

UNIT PACKAGE: 50



12351

(11505022)
Black Polyseal Finish

M6.3-1.81 x 20mm
(#14 x 25/32")
Hex Washer Head Sems®
17mm (11/16") Wshr O.D.
10mm Hex
GM

UNIT PACKAGE: 50



16828

Zinc & Yellow
Dichromate

M6.3-1.81 x 20mm
(#14 x 25/32")

Hex Head Sems®
18mm (45/64")
Washer O.D.

10mm Hex
Honda, Nissan & Toyota

UNIT PACKAGE: 25



12339

(11500996, 11505023)
Phosphate

M6.3-1.81 x 25mm
(#14 x 1")

Hex Head Sems®
17mm (21/32") Wshr O.D.
10mm Hex
GM

UNIT PACKAGE: 50



19417

(Chrys: 6503819, 6503401;
GM: 25631448)
Black Nylon

M7.5 x 35mm
Square Drive Truss Head
22mm Head Diameter
9mm Shoulder Diameter
Foam To Bumper Fascia

Chrysler
1993-On
GM 1997-On

UNIT PACKAGE: 15



10714

(9796223)
Phosphate

5/16"-12 x 1"
Hex Washer Head
21/32" Washer Head O.D.

1/2" Hex
GM

UNIT PACKAGE: 50



20557

Black Zinc

M6.3-1.81 x 20mm
(#14 x 25/32")

Phillips Hex Head Sems®
20mm (25/32") Washer O.D.
10mm Hex

Imports

UNIT PACKAGE: 50



12354

(11500997)
Phosphate

M6.3-1.81 x 30mm
(#14 x 1-3/16")

Hex Head Sems®
17mm (21/32")
Washer O.D.

10mm Hex
GM

UNIT PACKAGE: 50



12350

(11500086)
Phosphate

M8-2.12 x 20mm
(5/16"-12 x 25/32")

Hex Washer Head
16mm (5/8")
Washer Hd. O.D.

13mm Hex
GM

UNIT PACKAGE: 25



21517

(GM:
25705182)
Black Nylon

M9.5 x 46mm
Bumper Fascia
Nylon Screw
Head Diameter: 22mm
Square Drive
GM 2004 - On

UNIT PACKAGE: 25



18934

(6034703,
6035188)
Zinc Organic

#14 x 7/8"

Hex Washer Head
Serrations Under The
Washer Head
13/16" Washer Head O.D.
3/8" Hex

Front Fender & Fascia
Attachment
Chrysler 1993-On

UNIT PACKAGE: 25



12068

(11504981)
Phosphate

M6.3-1.81 x 30mm
(#14 x 1-3/16")

Hex Head Sems®
24mm(15/16") Washer O.D.
10mm Hex
GM

UNIT PACKAGE: 50



10364

Black Oxide

5/16"-12 x 7/8"
Hex Washer Head
21/32" Washer Head O.D.
1/2" Hex

UNIT PACKAGE: 100



20970

(Not Available
From O.E.M.)
Black Nylon

M14 x 34mm
Bumper and Door Insulator
Nylon Screw
22mm Head O.D.
No. 3 Square Drive
Fits Into 12mm Hole
GM, Ford & Chrysler
2005 - On

UNIT PACKAGE: 25

License Plate Screw Specification Chart

Sec. 5

Auveco
Part No.



Size

Length

Hex
Size

Washer/
Head O.D.

Type

Point
Type



Finish

Unit Page
Pkg. No.

Machine Screw Thread

18779	M5-0.8	12mm (15/32")		12.7mm (1/2")	Phillips Pan Washer Head	B	Zinc & Yellow Dichromate	100	35
17315	M6-1.0	12mm (15/32")	10mm	14mm (9/16")	Hex Flange Head	B	Zinc & Clear	50	35
17316	M6-1.0	16mm (5/8")	10mm	14mm (9/16")	Hex Flange Head	B	Zinc & Clear	50	35
14473	M6-1.0	16mm (5/8")		14mm (9/16")	Slotted Round Washer Head	B	Zinc	50	35
17152	M6-1.0	16mm (5/8")		14mm (9/16")	Slotted Round Washer Head	B	Black E-Coat	50	35
20680	M6-1.0	16mm (5/8")		14mm (9/16")	Phillips Round Washer Head	BT	Black Zinc	50	35
21181	M6-1.0	16mm (5/8")		12mm (15/32")	Slotted Pan Head With Hex Nut	B	Black Nylon	50 Sets	37
15413	M6-1.0	20mm (25/32")		12mm (15/32")	Slotted Pan Head With Hex Nut	B	Black Nylon	50 Sets	37
21606	M6-1.0	20mm (25/32")		12mm (15/32")	Phillips Pan Head With Hex Nut	B	Black Nylon	50 Sets	37
13934	M6-1.0	20mm (25/32")		12mm (15/32")	Slotted Pan Head With Hex Nut	B	Natural Nylon	25 Sets	37
18769	M6-1.0	20mm (25/32")		12mm (15/32")	Phillips Pan Head	B	Black E-Coat	50	36
16826	M6-1.0	20mm (25/32")	10mm	13mm (1/2")	Slotted Hex Washer Head	CA	Zinc	50	36
18239	M6-1.0	25mm (1")		12mm (15/32")	Slotted Pan Head With Hex Nut	B	Natural Nylon	25 Sets	38
18241	M6-1.0	25mm (1")		12mm (15/32")	Slotted Pan Head With Hex Nut	B	Black Nylon	25 Sets	38
13935	M8-1.25	20mm (25/32")		16mm (5/8")	Slotted Pan Head With Hex Nut	B	Natural Nylon	25 Sets	38
5908	1/4"-20	1/2"		9/16"	Slotted Round Head	B	Zinc	100	35
5909	1/4"-20	1/2"		1/2"	Slotted Round Washer Head	B	Zinc	100	35
1313	1/4"-20	1/2"		9/16"	Slotted Truss Head With Hex Nut	B	Zinc	100 Sets	36
3184	1/4"-20	1/2"		9/16"	Slotted Truss Head With Square Nut	B	Zinc	100 Sets	36
3182	1/4"-20	1/2"		1/2"	Slotted Round Washer Head With Hex Nut	B	Zinc	100 Sets	36
3183	1/4"-20	1/2"		1/2"	Slotted Round Washer Head With Square Nut	B	Zinc	100 Sets	36
5885	1/4"-20	1/2"		1/2"	Slotted Round Washer Head With Wing Nut	B	Zinc	50 Sets	36
8427	1/4"-20	5/8"		1/2"	Slotted Pan Head With Nylon Nut	F	Zinc	50 Sets	37

(Continued on Next Page)

Sec. 5

License Plate Screw Specification Chart



Auveco Part No.	Size	Length	Hex Size	Washer/ Head O.D.	Type	Point Type	Finish	Unit Pkg.	Page No.
-----------------	------	--------	----------	-------------------	------	------------	--------	-----------	----------

Machine Screw Thread (Continued)

13922	1/4"-20	5/8"		19/32"	Slotted Truss Washer Head With Washer Nut	B	Natural Nylon	25 Sets	37
18484	1/4"-20	5/8"		19/32"	Slotted Truss Washer Head With Washer Nut	B	Black Nylon	25 Sets	37
5910	1/4"-20	3/4"		9/16"	Slotted Truss Head	B	Zinc	100	36
2472	1/4"-20	3/4"		9/16"	Slotted Round Washer Head With Square Nut	B	Zinc	100 Sets	37

Tapping Screw Thread

18156	M4.8-1.59 (#10)	16mm (5/8")		10mm (3/8")	Phillips Wafer Head	AB	Zinc & Yellow	50	35
--------------	-----------------	-------------	--	-------------	---------------------	----	---------------	----	----

5278	#10	5/8"		1/2"	Slotted Truss Washer Head	AB	Zinc	100	35
17558	#10	3/4"		15/32"	Phillips Flat Washer Head	AB	Black E-Coat	100	35

17098	M6-1.81 (1/4"-14)	15mm (19/32")		13mm (1/2")	Phillips Truss Head	AB	Zinc & Yellow Dichromate	50	35
17980	M6-1.81 (1/4"-14)	16mm (5/8")	10mm	13mm (1/2")	Phillips Hex Washer Head	AB	Zinc & Yellow Dichromate	50	35
16960	M6-1.81 (1/4"-14)	20mm (25/32")	10mm	12mm (15/32")	Phillips Hex Washer Head	AB	Zinc & Yellow Dichromate	50	36

19777	M6.3-1.81 (#14)	16mm (5/8")		14mm (9/16")	Duo-Drive Truss Head	B	Dacromet 320	50	35
21081	M6.3-1.81 (#14)	20mm (25/32")		14mm (9/16")	Duo-Drive Truss Head	AB	Dacromet 320	50	36

15170	#14	1/2"			Thumb Screw	AB	Zinc Die Cast	25	36
15758	#14	5/8"		9/16"	Slotted Truss Head	Dog Pt.	Zinc	50	35
8249	1/4"	5/8"		9/16"	Slotted Round Washer Head	B	Zinc	100	35
8250	1/4"	5/8"		9/16"	Slotted Round Washer Head With Nylon Nut	B	Zinc	25 Sets	36
16421	#14 (1/4")	5/8"	5/16"	5/8"	Slotted Hex Washer Head	B	Black E-Coat	50	35
16422	#14 (1/4")	5/8"	5/16"	5/8"	Slotted Hex Washer Head	B	Zinc	50	35
20446	#14 (1/4")	5/8"	5/16"	5/8"	Slotted Hex Washer Head	AB	Black E-Coat	50	35
21069	#14	3/4"		15/32"	Phillips Pan Head	A	Stainless Steel	100	35
9603	#14	3/4"		9/16"	Slotted Truss Head	AB	Zinc	100	36
16323	#14	3/4"		9/16"	Slotted Truss Head	AB	Black E-Coat	100	36
11369	#14	3/4"	3/8"	1/2"	Slotted Hex Washer Head	AB	Zinc	50	36
11370	#14	3/4"	3/8"	1/2"	Slotted Hex Washer Head With Nylon Nut	AB	Zinc	25 Sets	37
18354	#14	3/4"	3/8"	1/2"	Slotted Hex Washer Head	AB	Black E-Coat	50	36
20301	#14	1-3/16"		9/16"	Slotted Truss Head	B	Black E-Coat	50	36

LICENSE PLATE FASTENERS
(ILLUSTRATIONS ACTUAL SIZE)



18156
(51-81-1-821-830)
Zinc & Yellow
M4.8-1.59 x 16mm
(#10 x 5/8")
Phillips Wafer Head
License Plate Screw
10mm (3/8") Head O.D.
BMW
UNIT PACKAGE: 50



5908
Zinc
1/4"-20 x 1/2"
Slotted Round Head
License Plate Screw
9/16" Head Diameter
UNIT PACKAGE: 100



16421
(N800369-S2)
Black E-Coat
#14 (1/4") x 5/8"
Slotted Hex Washer Head
License Plate Screw
5/8" Washer Head O.D.
5/16" Hex
Ford
UNIT PACKAGE: 50



14473
Zinc
M6-1.0 x 16mm
Slotted Round
Washer Head
License Plate Screw
14mm (9/16")
Washer Head O.D.
UNIT PACKAGE: 50



5278
(3783002)
Zinc
#10 x 5/8"
Slotted Truss Washer Head
License Plate Screw
1/2" Washer Head O.D.
GM
**Use With Auveco Nut
5228**
UNIT PACKAGE: 100



5909
Zinc
1/4"-20 x 1/2"
Slotted Round Wshr Head
License Plate Screw
1/2" Washer Head O.D.
UNIT PACKAGE: 100



16422
(N800369)
Zinc
#14 (1/4") x 5/8"
Slotted Hex Washer Head
License Plate Screw
5/8" Washer Head O.D.
5/16" Hex
Ford
UNIT PACKAGE: 50



17152
Black E-Coat
(168 Hours Salt Spray)
M6-1.0 x 16mm
Slotted Round Wshr Hd
License Plate Screw
14mm (9/16")
Washer Head O.D.
UNIT PACKAGE: 50



17558
Black E-Coat
(168 Hours Salt Spray)
#10 x 3/4"
Phillips Flat Washer Head
License Plate Screw
15/32" Washer Hd. O.D.
UNIT PACKAGE: 100



17098
Zinc & Yellow Dichromate
M6-1.81 x 15mm
(1/4"-14 x 19/32")
Phillips Truss Head
License Plate Screw
13mm (1/2") Head Dia.
UNIT PACKAGE: 50



20446
Black E-Coat
#14 (1/4") x 5/8"
Slotted Hex Washer Head
License Plate Screw
5/8" Washer Head O.D.
5/16" Hex
Ford
UNIT PACKAGE: 50



20680
Black Zinc
M6-1.0 x 16mm
Phillips Round Washer
Head Thread Cutting
License Plate Screw
Washer Head O.D.:
14mm (9/16")
Hyundai
UNIT PACKAGE: 50



18779
Zinc & Yellow Dichromate
M5-0.8 x 12mm
Phillips Pan Washer Head
License Plate Screw
12.7mm (1/2")
Washer Hd. O.D.
Ford Contour & Mercury
Mystique
1995-On
UNIT PACKAGE: 100



15758
Zinc
#14 x 5/8"
Slotted Truss Head
With Dog Point
License Plate Screw
9/16" Head O.D.
UNIT PACKAGE: 50



17980
Zinc & Yellow Dichromate
M6-1.81 x 16mm
(1/4"-14 x 5/8")
Phillips Hex Washer Head
License Plate Screw
13mm (1/2")
Washer Head O.D.
10mm Hex
UNIT PACKAGE: 50



19777
Dacromet 320
M6.3-1.81 x 16mm
(#14 x 5/8")
Duo-Drive Truss Head
License Plate Screw
14mm Head Diameter
GM
UNIT PACKAGE: 50



17315
Zinc & Clear
M6-1.0 x 12mm
Hex Flange
License Plate Screw
14mm (9/16") Flange O.D.
10mm Hex
Class 10.9
Acura
UNIT PACKAGE: 50



8249
Zinc
1/4" x 5/8"
Slotted Round Wshr Head
License Plate Screw
9/16" Washer Head O.D.
**Use With Auveco
Nut 8242**
UNIT PACKAGE: 100



17316
Zinc & Clear
M6-1.0 x 16mm
Hex Flange
License Plate Screw
14mm (9/16") Flange O.D.
10mm Hex
Class 10.9
Acura
UNIT PACKAGE: 50



21609
Stainless Steel
#14 x 3/4"
Phillips Pan Head
License Plate Screw
15/32" Head O.D.
UNIT PACKAGE: 100

Sec. 5**LICENSE PLATE FASTENERS**
(ILLUSTRATIONS ACTUAL SIZE)**5910**
Zinc1/4"-20 x 3/4"
Slotted Truss Head
License Plate Screw
9/16" Head Diameter
UNIT PACKAGE: 100**9603**
Zinc#14 x 3/4"
Slotted Truss Head
License Plate Screw
9/16" Head Diameter
UNIT PACKAGE: 100**16323**
Black E-Coat
(168 Hours Salt Spray)#14 x 3/4"
Slotted Truss Head
License Plate Screw
9/16" Head Diameter
UNIT PACKAGE: 100**18769**Black E-Coat
(168 Hours Salt Spray)M6-1.0 x 20mm
Phillips Pan Head
License Plate Screw
12mm (15/32") Head Dia.
UNIT PACKAGE: 50**16826**(Chry: 34201287;
AMC: 8934201287)
ZincM6-1.0 x 20mm
Slotted Hex Washer Head
License Plate Screw
13mm (1/2") Wshr Hd. O.D.
10mm Hex
Chrysler, Honda & AMC
UNIT PACKAGE: 50**16960**(Toyota: 93904-46320;
Honda: 91500-SM4-999AH)
Zinc & Yellow DichromateM6-1.81 x 20mm
(1/4"-14 x 3/4")
Phillips Hex Washer Head
License Plate Screw
12mm (1/2")
Wshr Hd. O.D.
10mm Hex
Honda 1990-On
GEO Prizm, Toyota
UNIT PACKAGE: 50**11369**
Zinc#14 x 3/4"
Slotted Hex Washer Head
License Plate Screw
1/2" Washer Head O.D.
3/8" Hex
Ford
UNIT PACKAGE: 50**18354**Black E-Coat
(168 Hours Salt Spray)#14 x 3/4"
Slotted Hex Washer Head
License Plate Screw
1/2" Washer Head O.D.
3/8" Hex
Ford
UNIT PACKAGE: 50**21081**(25732397)
Dacromet 320M6.3-1.81 x 20mm
(#14 x 3/4")
Duo-Drive Truss Head
License Plate Screw
14mm Head Diameter
GM
2002 - On
UNIT PACKAGE: 50**20301**(16502342)
Black E-Coat
(168 Hours Salt Spray)#14 x 1-3/16"
Slotted Truss Head
License Plate Screw
9/16" Head Diameter
GM S & T Trucks
1998 - On
UNIT PACKAGE: 50**15170**#14 x 1/2"
Dealer License Plate
Thumb Screw
1-1/8" Overall Length
UNIT PACKAGE: 25**1313**

Zinc

1/4"-20 x 1/2"
Slotted Truss Head
License Plate Screw
With Hex Nut
9/16" Head Diameter
7/16" Hex Width (ATF)
UNIT PACKAGE: 100 Sets**3184**

Zinc

1/4"-20 x 1/2"
Slotted Truss Head
License Plate Screw
With Square Nut
9/16" Head Diameter
7/16" ATF
UNIT PACKAGE: 100 Sets**3182**

Zinc

1/4"-20 x 1/2"
Slotted Round
Washer Head
License Plate Screw
With Hex Nut
1/2" Washer Head O.D.
7/16" Hex Width (ATF)
UNIT PACKAGE: 100 Sets**3183**

Zinc

1/4"-20 x 1/2"
Slotted Round Washer Hd
License Plate Screw
With Square Nut
1/2" Washer Head O.D.
7/16" ATF
UNIT PACKAGE: 100 Sets**5885**

Zinc

1/4"-20 x 1/2"
Slotted Round
Washer Head
License Plate Screw
With Flat Washer
And Wing Nut
1/2" Washer Head O.D.
5/8" Washer O.D.
UNIT PACKAGE: 50 Sets**8250**

Zinc

1/4" x 5/8"
Slotted Round Wshr Head
License Plate Screw
And Nylon Nut
(Auveco No. 8249 & 8242)
9/16" Washer Head O.D.
Chrysler
UNIT PACKAGE: 25 Sets

LICENSE PLATE FASTENERS

(ILLUSTRATIONS ACTUAL SIZE)

Sec. 5



8427
(379046-S)
Zinc

1/4"-20 x 5/8"
Slotted Pan Head
Type "F" Thread Cutting
License Plate Screw
And Nylon Nut
(Auveco No. 5307 & 3682)
1/2" Head Diameter

UNIT PACKAGE: 50 Sets



2472
Zinc

1/4"-20 x 3/4"
Slotted Truss Head
License Plate Screw
With Square Nut
9/16" Head Diameter
7/16" ATF

UNIT PACKAGE: 100 Sets



11370
Zinc

#14 x 3/4"
Slotted Hex Washer Head
License Plate Screw
And Nylon Nut
(Auveco # 11368 &
11369)
1/2" Washer Head O.D.
3/8" Hex
Ford

UNIT PACKAGE: 25 Sets



13922
Natural Nylon

1/4"-20 x 5/8"
Slotted Truss
Washer Head
19/32" Washer Head O.D.
9/16" Washer Nut O.D.
7/16" Hex Width (ATF)

UNIT PACKAGE: 25 Sets

17171
Screw Only From 13922
UNIT PACKAGE: 50

18342
Screw Only From 13922
UNIT PACKAGE: 1000

17228
Nut Only From 13922
UNIT PACKAGE: 50

18346
Nut Only From 13922
UNIT PACKAGE: 1000



18484
Black Nylon

1/4"-20 x 5/8"
Slotted Truss
Washer Head
19/32" Washer Head O.D.
9/16" Washer Nut O.D.
7/16" Hex Width (ATF)

UNIT PACKAGE: 25 Sets

18485
Screw Only From 18484
UNIT PACKAGE: 50

18486
Screw Only From 18484
UNIT PACKAGE: 1000

18487
Nut Only From 18484
UNIT PACKAGE: 50

18488
Nut Only From 18484
UNIT PACKAGE: 1000



21181
Black Nylon

M6-1.0 x 16mm
Slotted Pan Head
12mm (15/32") Head Dia.
10mm (25/64")
Hex Width (ATF)

UNIT PACKAGE: 50 Sets

21182
Screw Only From 21181
UNIT PACKAGE: 100

21183
Screw Only From 21181
UNIT PACKAGE: 1000

18348
Nut Only From 21181
UNIT PACKAGE: 1000



15413
Black Nylon

M6-1.0 x 20mm
Slotted Pan Head
12mm (15/32") Head Dia.
10mm (25/64")
Hex Width (ATF)

UNIT PACKAGE: 50 Sets

17091
Screw Only From 15413
UNIT PACKAGE: 100

18344
Screw Only From 15413
UNIT PACKAGE: 1000

18348
Nut Only From 15413
UNIT PACKAGE: 1000



13934
Natural Nylon

M6-1.0 x 20mm
Slotted Pan Head
12mm (15/32") Head Dia.
10mm (25/64")
Hex Width (ATF)

UNIT PACKAGE: 25 Sets

17169
Screw Only From 13934
UNIT PACKAGE: 100

18343
Screw Only From 13934
UNIT PACKAGE: 1000

18347
Nut Only From 13934
UNIT PACKAGE: 1000



21606
Black Nylon

M6-1.0 x 20mm
Phillips Pan Head
12mm (15/32") Head Dia.
10mm (25/64")
Hex Width (ATF)

UNIT PACKAGE: 50 Sets

21607
Screw Only From 21606
UNIT PACKAGE: 100

21608
Screw Only From 21606
UNIT PACKAGE: 1000

18348
Nut Only From 21606
UNIT PACKAGE: 1000

LICENSE PLATE FASTENERS

(ILLUSTRATIONS ACTUAL SIZE)



18239

Natural Nylon

M6-1.0 x 25mm
Slotted Pan Head
12mm (15/32") Head Dia.
10mm (25/64")
Hex Width (ATF)

UNIT PACKAGE: 25 Sets

18238

Screw Only From 18239

UNIT PACKAGE: 50



18241

Black Nylon

M6-1.0 x 25mm
Slotted Pan Head
12mm (15/32") Head Dia.
10mm (25/64")
Hex Width (ATF)

UNIT PACKAGE: 25 Sets

18240

Screw Only From 18241

UNIT PACKAGE: 50



13935

Natural Nylon

M8-1.25 x 20mm
Slotted Pan Head
16mm (5/8") Head Dia.
8mm (5/16") Hex Width (ATF)

UNIT PACKAGE: 25 Sets

18345

Screw Only From 13935

UNIT PACKAGE: 1000

18349

Nut Only From 13935

UNIT PACKAGE: 1000



16669

Bagged Hardware

2 Pieces Each of 9603
(#14 x 3/4" Slotted Truss
Head Screw) And 11719
(Nylon Nut) Packaged
In Unmarked, See-Thru Plastic Bags.

UNIT PACKAGE: 50 Sets



16670

Bagged Hardware

4 Pieces Each of 9603
(#14 x 3/4" Slotted Truss
Head Screw) And 11719
(Nylon Nut) Packaged
In Unmarked, See-Thru
Plastic Bags.

UNIT PACKAGE: 50 Sets

16690

Same As 16670 Except
For Unit Package Quantity

UNIT PACKAGE: 100 Sets



16800

Nylon Screw,
Spacer & Washer
Brass Nut

M6-1.0 x 20mm
Slotted Pan Head License
Plate Screw & Hardware
12mm (15/32") Head Dia.
10mm (25/64") Hex Width (ATF)
12.5mm (1/2") Washer O.D.
19mm (3/4") Spacer O.D.
Toyota

UNIT PACKAGE: 25 Sets



17636

Nylon

License Plate
Bracket Spacer
1/4" (6mm) I.D.
3/4" (19mm) O.D.
1/4" (6mm) Thick
Toyota

UNIT PACKAGE: 50



2625

Nylon

#8 Screw Size
License Plate Nut &
Headlight Door Mounting
Screw Nut
Chrysler

UNIT PACKAGE: 100



5228

(3783006)

Nylon

#10 Screw Size
License Plate Nut
GM

Use With Auveco Screw 5278

UNIT PACKAGE: 50



13466

(6032516)

Black Nylon

License Plate Nut
#12 Screw Size
Chrysler

UNIT PACKAGE: 25

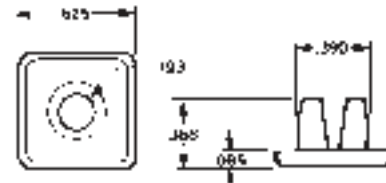

3682

(1196781)

Nylon

1/4"-20 Screw Size
License Plate Nut
GM

Use With Auveco Screw 5307

UNIT PACKAGE: 50

LICENSE PLATE FASTENERS

(ILLUSTRATION ACTUAL SIZE)

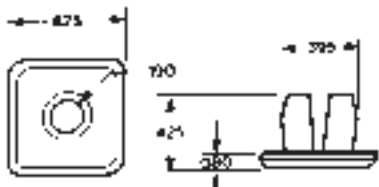

8435
(4755299)
Nylon

1/4" (#14) Screw Size
License Plate Nut
GM

UNIT PACKAGE: 50

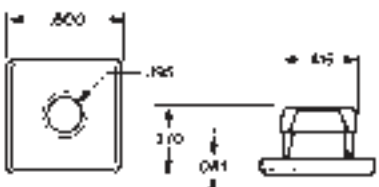

8418
(380370)
Nylon

1/4" (#14) Screw Size
License Plate Nut
GM

UNIT PACKAGE: 50



20927
(N811478-S100)
Black Nylon

License Plate & Rear Bumper
Nylon Nut With Sealer
M6.3 (#14) Screw Size
Head Size: 16mm x 16mm
Stem Length: 8mm
Ford Fusion & Mustang
2005 - On

UNIT PACKAGE: 15



11368
(380707-S)
Nylon

#14 Screw Size
License Plate Nut
Ford

UNIT PACKAGE: 50



8242
(6023925)
Nylon

1/4" (#14) Screw Size
License Plate Nut
Chrysler

Use With Auveco Screw 8249

UNIT PACKAGE: 50



8418
(380370)
Nylon

#14 Screw Size
License Plate Nut
GM

Use With Auveco Screw 3089

UNIT PACKAGE: 50



8954
Nylon

#14 Screw Size
License Plate Nut
**Use With Auveco Screws
8249 or 8952**

UNIT PACKAGE: 50



19485
(6027958)
Natural Nylon

1/4" (#14) Screw Size
License Plate Nut
Chrysler

UNIT PACKAGE: 10



20937
(22546934)
Black Nylon

License Plate
Screw Grommet
M6.3 (#14) Screw Size
Head Size: 20mm x 20mm
Stem Length: 14mm
Buick Skylark, Chevrolet
Malibu, Oldsmobile Achieva,
Cutlass & Intrigue
1992 - On

UNIT PACKAGE: 50



19317
(15707256)
Zinc Organic

Front Fender Extension
& License Plate Bracket
Retainer Nut
M6-1.0 Screw Size
GM Express & Savanna
1996-On

UNIT PACKAGE: 10



21014
(10266978)
White Nylon

License Plate
Screw Grommet
#14 (M6.3) Screw Size
Head Size: 17mm x 33mm
Stem Length: 9mm
GM 1997 - On

UNIT PACKAGE: 15

**When The World Thinks Of
Body Hardware & Specialty
Fasteners Only One Name
Comes To Mind...**



Sec. 6

CYLINDER HEAD AND MANIFOLD STUDS

Grade 8 Medium Carbon Heat Treated Alloy Steel

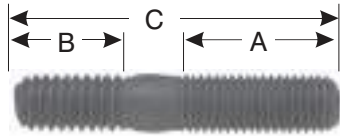

Auveco Part No.	A Dia. & Length	B Dia & Length	C Overall Length	Unit Pkg.
19595•	1/4"-20 USS x 1/2"	1/4"-20 USS x 8"	9"	10
9667	1/4"-28 SAE x 3/8"	1/4"-20 USS x 7/16"	1"	10
9668	1/4"-28 SAE x 1/2"	1/4"-20 USS x 1/2"	1-1/4"	10
9669	1/4"-28 SAE x 3/4"	1/4"-20 USS x 1/2"	1-1/2"	10
9670	1/4"-28 SAE x 1"	1/4"-20 USS x 1/2"	2"	10
9673	5/16"-24 SAE x 7/16"	5/16"-18 USS x 7/16"	1"	10
9674	5/16"-24 SAE x 5/8"	5/16"-18 USS x 1/2"	1-1/4"	10
9675	5/16"-24 SAE x 5/8"	5/16"-18 USS x 3/4"	1-1/2"	10
9676	5/16"-24 SAE x 7/8"	5/16"-18 USS x 9/16"	1-3/4"	10
9677	5/16"-24 SAE x 1"	5/16"-18 USS x 9/16"	2"	10
14824	5/16"-24 SAE x 1-5/8"	5/16"-18 USS x 1/2"	2-1/2"	10
9679	5/16"-18 USS x 7/8"	5/16"-18 USS x 7/16"	1-1/2"	10
9680	5/16"-18 USS x 1"	5/16"-18 USS x 7/16"	2"	10
9681	5/16"-24 SAE x 1-1/2"	5/16"-18 USS x 5/8"	3"	10
9683	3/8"-24 SAE x 3/4"	3/8"-16 USS x 1/2"	1-1/2"	10
9684	3/8"-24 SAE x 3/4"	3/8"-16 USS x 1/2"	1-3/4"	10
9685	3/8"-24 SAE x 3/4"	7/16"-14 USS x 7/8"	1-7/8"	10
9686	3/8"-24 SAE x 1"	3/8"-16 USS x 5/8"	2"	10
9687	3/8"-16 USS x 1"	3/8"-16 USS x 3/4"	2"	10
9688	3/8"-16 USS x 1"	3/8"-16 USS x 5/8"	2-1/8"	10
14827*	3/8"-16 USS x 1-5/8"	3/8"-16 USS x 7/16"	2-7/32"	10
19597*	3/8"-16 USS x 1/2"	3/8"-16 USS x 1-7/8"	2-1/2"	10
9689	3/8"-24 SAE x 1"	3/8"-16 USS x 3/4"	2-3/4"	10
12129	3/8"-16 USS x 5/8"	3/8"-16 USS x 2"	3"	10
9690	3/8"-24 SAE x 2"	3/8"-16 USS x 5/8"	3"	10
9692	3/8"-16 USS x 1-5/8"	3/8"-16 USS x 7/16"	3-1/4"	10
9694	3/8"-24 SAE x 1"	3/8"-16 USS x 3/4"	3-3/4"	10
9695	3/8"-16 USS x 2"	3/8"-16 USS x 3/4"	4"	10
9696	3/8"-24 SAE x 1-7/8"	3/8"-16 USS x 1/2"	4"	10
9697	7/16"-20 SAE x 3/4"	7/16"-14 USS x 1/2"	1-1/2"	10
9699	7/16"-20 SAE x 3/4"	7/16"-14 USS x 9/16"	1-3/4"	10
9701	7/16"-20 SAE x 7/8"	7/16"-14 USS x 3/4"	2"	10
9702	7/16"-14 USS x 15/16"	7/16"-14 USS x 3/4"	2"	10
9705	7/16"-20 SAE x 3/4"	7/16"-14 USS x 3/4"	2-1/4"	10
9709	7/16"-20 SAE x 7/8"	7/16"-14 USS x 3/4"	2-1/2"	10
9711	7/16"-14 USS x 1-1/4"	7/16"-14 USS x 3/4"	2-1/2"	10
9712	7/16"-20 SAE x 1-3/8"	7/16"-14 USS x 3/4"	2-1/2"	10
9715	7/16"-20 SAE x 1-13/16"	7/16"-14 USS x 3/4"	3"	10
19598	7/16"-14 USS x 1-7/8"	7/16"-14 USS x 3/4"	3-1/4"	10
9727	1/2"-20 SAE x 3/4"	1/2"-13 USS x 3/4"	1-7/8"	10
9728	1/2"-20 SAE x 15/16"	1/2"-13 USS x 13/16"	2"	10
9729	1/2"-20 SAE x 1"	1/2"-13 USS x 3/4"	2-1/4"	10
9731	1/2"-20 SAE x 1"	1/2"-13 USS x 3/4"	2-1/2"	10
9732	1/2"-20 SAE x 2"	1/2"-13 USS x 3/4"	3"	10
9739	9/16"-18 SAE x 1-1/4"	9/16"-12 USS x 1"	3"	10
9743	5/8"-18 SAE x 1"	5/8"-11 USS x 3/4"	2-1/2"	10
9744	5/8"-11 USS x 1-1/2"	5/8"-11 USS x 13/16"	2-3/4"	10
9745	5/8"-18 SAE x 1-1/4"	5/8"-11 USS x 1"	3"	10
9748**	3/4"-10 USS x 1-9/16"	3/4"-10 USS x 1-1/16"	2-13/16"	10

•Grade 2, Zinc Plated

*w/Dog Point

** Zinc Plated

CYLINDER HEAD AND MANIFOLD METRIC STUDS

Grade 8 Medium Carbon Heat Treated Alloy Steel

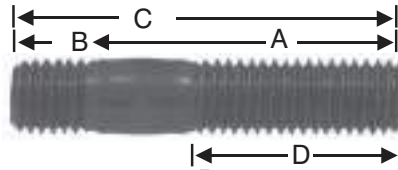

Auveco Part No.	A Diameter & Length	B Diameter & Length	C Overall Length	D Length	Unit Pkg.
11973	6mm-1.00 x 20mm	6mm-1.00 x 7.5mm	27.5mm	18mm	10
11974	6mm-1.00 x 25mm	6mm-1.00 x 7.5mm	32.5mm	18mm	10
11980	8mm-1.25 x 20mm	8mm-1.25 x 10mm	30.0mm	16mm	10
11981	8mm-1.25 x 25mm	8mm-1.25 x 10mm	35.0mm	22mm	10
11982	8mm-1.25 x 30mm	8mm-1.25 x 10mm	40.0mm	22mm	10
11983	8mm-1.25 x 35mm	8mm-1.25 x 10mm	45.0mm	22mm	10
11984	8mm-1.25 x 40mm	8mm-1.25 x 10mm	50.0mm	22mm	10
11987	8mm-1.25 x 55mm	8mm-1.25 x 10mm	65.0mm	22mm	10
11989	10mm-1.50 x 30mm	10mm-1.50 x 12mm	42.0mm	18mm	10
11990	10mm-1.50 x 35mm	10mm-1.50 x 12mm	47.0mm	26mm	10
11991	10mm-1.50 x 40mm	10mm-1.50 x 12mm	52.0mm	26mm	10
11993	10mm-1.50 x 50mm	10mm-1.50 x 12mm	62.0mm	26mm	10
11995	10mm-1.50 x 65mm	10mm-1.50 x 12mm	77.0mm	26mm	5
11998	12mm-1.75 x 30mm	12mm-1.75 x 15mm	45.0mm	25mm	5



11404
(N14-4003)
Plain
M8-1.25 x 35mm
Class 4.8
Volkswagen Intake Manifold
UNIT PACKAGE: 25



17560
Zinc & Yellow Dichromate
M10-1.25 x 48mm
Dim. A: 15mm; Dim. B: 25mm
Class 8.8
Exhaust Systems
Honda, Nissan & Toyota
UNIT PACKAGE: 10



17559
Zinc & Yellow Dichromate
M10-1.25 x 42mm
Class 8.8
Exhaust Systems
Honda, Nissan & Toyota
UNIT PACKAGE: 10



17596
Zinc & Yellow Dichromate
M12-1.25 x 50mm
Class 8.8
Catalytic Converter
Mazda
UNIT PACKAGE: 5

View the Auveco catalog on-line at www.auveco.com.
You can search by Auveco part number, description,
OEM number and competitive part number.



**Phillips Pan Head
Metric Machine Screws**
DIN 7985
Regular Pitch • Zinc Plated

Auveco Part No.	Diameter & Pitch	Length	Unit Pkg.
15867	4mm-.70	8mm	100
15868	4mm-.70	10mm	100
15869	4mm-.70	16mm	100
15870	5mm-.80	8mm	100
15871	5mm-.80	10mm	100
15872	5mm-.80	12mm	100
15873	5mm-.80	16mm	100
15874	5mm-.80	20mm	100
15875	5mm-.80	25mm	100
15876	6mm-1.00	10mm	100
15877	6mm-1.00	12mm	100
15878	6mm-1.00	16mm	50
15879	6mm-1.00	20mm	50
15880	6mm-1.00	25mm	50
15881	6mm-1.00	30mm	50



**Slotted Pan Head
Metric Machine Screws**
DIN 85
Regular Pitch • Zinc Plated

Auveco Part No.	Diameter & Pitch	Length	Unit Pkg.
10427	4mm-.70	10mm	25
10431	5mm-.80	12mm	25
10436	6mm-1.00	10mm	25
14391	6mm-1.00	10mm	100
10437	6mm-1.00	12mm	25
14392	6mm-1.00	12mm	100
10438	6mm-1.00	16mm	25
14393	6mm-1.00	16mm	100
10439	6mm-1.00	18mm	25
14394	6mm-1.00	18mm	100
10440	6mm-1.00	20mm	25
14395	6mm-1.00	20mm	100
10441	6mm-1.00	25mm	25
10442	6mm-1.00	30mm	25



**Slotted Flat Fillister Head
Metric Machine Screws**
DIN 84
Regular Pitch • Zinc Plated

Auveco Part No.	Diameter & Pitch	Length	Unit Pkg.
10459	5mm-.80	16mm	25
10460	5mm-.80	20mm	25
14396	6mm-1.00	10mm	100
10463	6mm-1.00	16mm	25
14397	6mm-1.00	16mm	100
10464	6mm-1.00	20mm	25
14398	6mm-1.00	20mm	50
10466	6mm-1.00	30mm	25
10476	10mm-1.50	35mm	5



**Phillips Oval Head
Metric Machine Screws**
DIN 966
Regular Pitch • Zinc Plated

Auveco Part No.	Diameter & Pitch	Length	Unit Pkg.
15888	5mm-.80	12mm	100
15890	5mm-.80	20mm	100
15892	6mm-1.00	10mm	100
15893	6mm-1.00	12mm	100
15895	6mm-1.00	20mm	50
15896	6mm-1.00	25mm	50

METRIC ITEMS

**Slotted Flat Head Metric Machine Screws
DIN 963 (Medium Head)**



Regular Pitch • Zinc Plated

Auveco Part No.	Diameter & Pitch	Length	Unit Pkg.	Auveco Part No.	Diameter & Pitch	Length	Unit Pkg.
10478	4mm-.70	8mm	25	10497	10mm-1.50	25mm	10
10480	4mm-.70	15mm	25	10498	10mm-1.50	30mm	10
10488	6mm-1.00	25mm	25				

DIN 931 & DIN 933

Regular Pitch Metric Hex Head Cap Screws



Fully Threaded • Zinc Plated • 8.8 Heat Treated Alloy Steel
Tensile Strength: 116,000 PSI

Auveco Part No.	Diameter & Pitch	Length	Unit Pkg.	Auveco Part No.	Diameter & Pitch	Length	Unit Pkg.
4mm (7mm Hex)				10512	6mm-1.00	25mm	10
14581	4mm-.7	12mm	50	14410	6mm-1.00	25mm	25
10501	4mm-.7	16mm	25	16700	6mm-1.00	25mm	100
14400	4mm-.7	16mm	50	10513	6mm-1.00	30mm	10
10502	4mm-.7	20mm	25	14411*	6mm-1.00	30mm	25
14401	4mm-.7	20mm	50	16701*	6mm-1.00	30mm	100
14582	4mm-.7	25mm	50	10514*	6mm-1.00	35mm	10
5mm (8mm Hex)				14412*	6mm-1.00	35mm	25
10504	5mm-.8	10mm	25	10515*	6mm-1.00	40mm	10
14402	5mm-.8	10mm	50	14413*	6mm-1.00	40mm	25
14583	5mm-.8	12mm	50	10516*	6mm-1.00	45mm	10
10505	5mm-.8	16mm	25	14414*	6mm-1.00	45mm	25
14403	5mm-.8	16mm	50	14585*	6mm-1.00	50mm	25
10506	5mm-.8	20mm	25	15514*	6mm-1.00	60mm	25
14404	5mm-.8	20mm	50	7mm(11mm Hex)			
10507	5mm-.8	25mm	25	14586	7mm-1.00	12mm	25
14405	5mm-.8	25mm	50	10517	7mm-1.00	16mm	10
10508	5mm-.8	30mm	10	14415	7mm-1.00	16mm	25
14406	5mm-.8	30mm	25	10519	7mm-1.00	25mm	10
15512	5mm-.8	40mm	50	14417	7mm-1.00	25mm	25
6mm (10mm Hex)				10520	7mm-1.00	30mm	10
14584	6mm-1.00	10mm	50	14418	7mm-1.00	30mm	25
10509	6mm-1.00	12mm	25	14587	7mm-1.00	40mm	25
14407	6mm-1.00	12mm	50	8mm (13mm Hex)			
16697	6mm-1.00	12mm	100	14588	8mm-1.25	12mm	25
10510	6mm-1.00	16mm	10	10521	8mm-1.25	16mm	10
14408	6mm-1.00	16mm	25	14419	8mm-1.25	16mm	25
16698	6mm-1.00	16mm	100	16702	8mm-1.25	16mm	50
10511	6mm-1.00	20mm	10	10522	8mm-1.25	20mm	10
14409	6mm-1.00	20mm	25	14420	8mm-1.25	20mm	25
16699	6mm-1.00	20mm	100	16703	8mm-1.25	20mm	50

*DIN 931 - Not Fully Threaded

(Continued on next page)



DIN 931 & DIN 933
Regular Pitch Metric Hex Head Cap Screws
 Fully Threaded • Zinc Plated • 8.8 Heat Treated Alloy Steel
 Tensile Strength: 116,000 PSI

Auveco Part No.	Diameter & Pitch	Length	Unit Pkg.	Auveco Part No.	Diameter & Pitch	Length	Unit Pkg.
8mm (13mm Hex) Continued				10541*	10mm-1.50	55mm	5
10523	8mm-1.25	25mm	10	14437*	10mm-1.50	55mm	10
14421	8mm-1.25	25mm	25	10542*	10mm-1.50	60mm	5
16704	8mm-1.25	25mm	50	14438*	10mm-1.50	60mm	10
10524	8mm-1.25	30mm	10	16714*	10mm-1.50	60mm	25
14422	8mm-1.25	30mm	25	10543*	10mm-1.50	70mm	5
16705	8mm-1.25	30mm	50	14439*	10mm-1.50	70mm	10
10525*	8mm-1.25	35mm	10	15515*	10mm-1.50	80mm	10
14423*	8mm-1.25	35mm	25	15516*	10mm-1.50	90mm	10
16706*	8mm-1.25	35mm	50	15517*	10mm-1.50	100mm	10
10526*	8mm-1.25	40mm	10	12mm (19mm Hex)			
14424*	8mm-1.25	40mm	25	10544	12mm-1.75	25mm	5
16707*	8mm-1.25	40mm	50	14440	12mm-1.75	25mm	10
10527*	8mm-1.25	45mm	10	16715	12mm-1.75	25mm	25
14425*	8mm-1.25	45mm	25	10545	12mm-1.75	30mm	5
10528*	8mm-1.25	50mm	10	14441	12mm-1.75	30mm	10
14426*	8mm-1.25	50mm	25	16716	12mm-1.75	30mm	25
10529*	8mm-1.25	55mm	10	10546	12mm-1.75	35mm	5
14427*	8mm-1.25	55mm	25	14442	12mm-1.75	35mm	10
10530*	8mm-1.25	60mm	10	16717	12mm-1.75	35mm	25
14428*	8mm-1.25	60mm	25	10547	12mm-1.75	40mm	5
10531*	8mm-1.25	65mm	5	14443	12mm-1.75	40mm	10
10532	8mm-1.25	70mm	5	16718	12mm-1.75	40mm	25
14429	8mm-1.25	70mm	10	10548*	12mm-1.75	45mm	5
14589*	8mm-1.25	75mm	10	14444*	12mm-1.75	45mm	10
17399*	8mm-1.25	80mm	15	10549*	12mm-1.75	50mm	5
17400*	8mm-1.25	90mm	15	14445*	12mm-1.75	50mm	10
17401*	8mm-1.25	100mm	10	10550*	12mm-1.75	60mm	5
10mm (17mm Hex)				14446*	12mm-1.75	60mm	10
10534	10mm-1.50	20mm	10	10551*	12mm-1.75	70mm	5
14430	10mm-1.50	20mm	25	14447*	12mm-1.75	70mm	10
16708	10mm-1.50	20mm	50	17403*	12mm-1.75	80mm	10
10535	10mm-1.50	25mm	10	17404*	12mm-1.75	90mm	10
14431	10mm-1.50	25mm	25	17405*	12mm-1.75	100mm	5
16709	10mm-1.50	25mm	50	14mm (22mm Hex)			
10536	10mm-1.50	30mm	10	14590	14mm-2.0	30mm	10
14432	10mm-1.50	30mm	25	14591	14mm-2.0	40mm	10
16710	10mm-1.50	30mm	50	14592	14mm-2.0	50mm	10
10537	10mm-1.50	35mm	5	14593*	14mm-2.0	60mm	10
14433	10mm-1.50	35mm	15	16mm (24mm Hex)			
16711	10mm-1.50	35mm	25	14595	16mm-2.0	30mm	5
10538*	10mm-1.50	40mm	5	14598*	16mm-2.0	60mm	5
14434*	10mm-1.50	40mm	15	20mm (30mm Hex)			
16712*	10mm-1.50	40mm	25	14602	20mm-2.5	60mm	5
10539*	10mm-1.50	45mm	5	*DIN 931 - Not Fully Threaded			
14435*	10mm-1.50	45mm	15				
10540*	10mm-1.50	50mm	5				
14436*	10mm-1.50	50mm	15				
16713*	10mm-1.50	50mm	25				

METRIC ITEMS

J.I.S. Small Head Cap Screws



J.I.S. B 1180 • Steel • Heat Treated • I.S.O. Class 8.8 • Zinc Plated

J.I.S. fasteners have a smaller hex dimension (across the flats) than DIN or ISO metric fasteners. They fit in those tight spots where the hex of an ISO or DIN fastener is too large. J.I.S. fasteners are OEM equipment on many GM and Japanese import car applications.

Auveco Part No.	Diameter & Pitch	Length	Unit Pkg.
M8-1.25 (12mm Hex)			
14777	8mm-1.25	16mm	25
14778	8mm-1.25	20mm	25
14779	8mm-1.25	25mm	25
14780	8mm-1.25	30mm	25
14781	8mm-1.25	35mm	25
14782	8mm-1.25	40mm	25
14784	8mm-1.25	50mm	25
M10-1.25 (14mm Hex)			
14787	10mm-1.25	20mm	25
14788	10mm-1.25	25mm	25
14789	10mm-1.25	30mm	25
14790	10mm-1.25	35mm	15

Auveco Part No.	Diameter & Pitch	Length	Unit Pkg.
14791	10mm-1.25	40mm	15
14792	10mm-1.25	45mm	15
14793	10mm-1.25	50mm	15
14794	10mm-1.25	60mm	10
14795	10mm-1.25	70mm	10
M12-1.25 (17mm Hex)			
16609	12mm-1.25	20mm	10
16610	12mm-1.25	25mm	10
16611	12mm-1.25	30mm	10
16612	12mm-1.25	35mm	10
16613	12mm-1.25	40mm	10
16614	12mm-1.25	50mm	10



DIN 960 & DIN 961

Fine Pitch Metric Hex Head Cap Screws
Fully Threaded • 8.8 Heat Treated Alloy Steel • Black Finish
Tensile Strength: 116,000 PSI

Auveco Part No.	Diameter & Pitch	Length	Unit Pkg.
8mm (13mm Hex)			
11255	8mm-1.00	10mm	10
11256	8mm-1.00	20mm	10
11257	8mm-1.00	25mm	10
11258	8mm-1.00	35mm	10
11259	8mm-1.00	40mm	10
14604*	8mm-1.00	50mm	25
10mm (17mm Hex)			
11262	10mm-1.00	30mm	10
11263	10mm-1.00	40mm	10
11264	10mm-1.00	50mm	10
14605	10mm-1.25	20mm	10
11265	10mm-1.25	25mm	10
11266	10mm-1.25	30mm	10
11267	10mm-1.25	35mm	10
11268	10mm-1.25	40mm	10
11269	10mm-1.25	50mm	10
14606*	10mm-1.25	60mm	10

Auveco Part No.	Diameter & Pitch	Length	Unit Pkg.
12mm (19mm Hex)			
11270	12mm-1.25	25mm	10
14607	12mm-1.25	30mm	5
11271	12mm-1.25	35mm	5
14608	12mm-1.25	40mm	5
14610*	12mm-1.25	70mm	5
11273	12mm-1.50	20mm	10
11274	12mm-1.50	30mm	10
11275	12mm-1.50	40mm	5
11276	12mm-1.50	50mm	5
14mm (22mm Hex)			
14611	14mm-1.50	30mm	5
14612	14mm-1.50	40mm	5
14613	14mm-1.50	50mm	5
16mm (24mm Hex)			
14616	16mm-1.50	30mm	5
14617	16mm-1.50	40mm	5
14618	16mm-1.50	50mm	5

*DIN 960 - Not Fully Threaded



Metric Hex Socket Head Cap Screws

DIN 912

Regular Pitch - Grade 12.9

Heat Treated Alloy Steel • Plain Finish

Tensile Strength: 177,000 PSI

Auveco Part No.		Diameter & Pitch	Length
Unit Package			
10	100		
10845	10872	4mm-.7	12mm
10846	10873	5mm-.8	12mm
10848	10875	5mm-.8	20mm
10851	10878	6mm-1.00	16mm
10853	6mm-1.00	25mm
10854	6mm-1.00	30mm
10855	8mm-1.25	16mm
10858	10885	8mm-1.25	30mm
10859	8mm-1.25	35mm
10861	10mm-1.50	20mm
10863	10mm-1.50	30mm
10864	10mm-1.50	40mm
10865	10mm-1.50	50mm
10866	12mm-1.75	30mm
10867	12mm-1.75	35mm
10868	12mm-1.75	40mm
10870	12mm-1.75	60mm



Metric Low Socket Head Cap Screws

DIN 6912

Regular Pitch - Grade 8.8

Heat Treated Alloy Steel • Plain Finish

Tensile Strength: 116,000 PSI

Auveco Part No.	Unit Pkg.	Diameter & Pitch	Length
10898	10	5mm-.8	10mm

All items available in bulk.

**Please Order
In Unit Package Quantities
Not Number Of Pieces**



Metric Flat Head Socket Cap Screws

DIN 7991

Regular Pitch - Grade 10.9

Heat Treated Alloy Steel • Plain Finish • Tensile Strength: 150,800 PSI

Auveco Part No.		Diameter & Pitch	Length
Unit Package			
10	100		
10960	10961	6mm-1.00	16mm

Auveco Part No.	Unit Package	Diameter & Pitch	Length
10970	10	8mm-1.25	20mm
10972	10	8mm-1.25	25mm



Metric Socket Set Screws - Cup Point

DIN 916
Regular Pitch - Grade 12.9
Heat Treated Alloy Steel
Plain Finish

Auveco Part No.	Diameter & Pitch	Length	Unit Pkg.
11006	5mm-.8	10mm	10
11008	5mm-.8	16mm	10
11022	8mm-1.25	16mm	10
11024	8mm-1.25	20mm	10
11032	10mm-1.50	20mm	10

Metric Hex Key Plain Finish



Use With Din 912 & Din 7991

Auveco Part No.	Hex Size	For Screw Size	Unit Pkg.
7965	3mm	4mm	10

Hex Head Sems® Split Wave Washer Body Bolts For Import Cars

Class 9.8 • Zinc & Yellow Dichromate Plated



Auveco Part No.	Size	Hex Size	Washer O.D.	Unit Pkg.
16751	M6-1.0 x 30mm	10mm	11mm	25
16753	M8-1.25 x 25mm	13mm	14mm	25
16754	M8-1.25 x 30mm	13mm	14mm	25
16755	M8-1.25 x 40mm	13mm	14mm	25



Hex Head Sems® Split Wave Washer Body Bolts With Flat Washers

(Flat Washer is packed loose in box)
For Import Cars

Class 9.8 • Zinc & Yellow Dichromate Plated

Auveco Part No.	Size	Hex Size	Wave Washer O.D.	Flat Washer O.D.	Unit Pkg.
16757	M6-1.0 x 25mm	10mm	11mm	12mm	25
16758	M6-1.0 x 30mm	10mm	11mm	12mm	25
16760	M8-1.25 x 25mm	13mm	14mm	17mm	25
16761	M8-1.25 x 30mm	13mm	14mm	17mm	25
16762	M8-1.25 x 40mm	13mm	14mm	17mm	25



Hex Head Sems® Body Bolts For Import Cars

Class 8.8

Zinc & Yellow Dichromate Plated

Auveco Part No.	Size	Hex Size	Washer O.D.	Unit Pkg.
20434	M6-1.0 x 12mm	10mm	12.5mm	50
18177	M6-1.0 x 16mm	10mm	12.5mm	50
20435	M6-1.0 x 20mm	10mm	12.5mm	50
18180	M6-1.0 x 30mm	10mm	12.5mm	50
18187	M8-1.25 x 45mm	12mm	17mm	25

METRIC ITEMS

Metric Hex Flange Serrated Bolts



Serrations Under The Head
Class 10.9 (Property Class 90)
Black Phosphate

Auveco Part No.	Size	Hex	Unit Pkg.
16793	M6-1.0 x 16mm	10mm	25
16794	M6-1.0 x 20mm	10mm	25
16795	M8-1.25 x 16mm	13mm	25
16796	M8-1.25 x 20mm	13mm	25
16797	M8-1.25 x 25mm	13mm	25



J.I.S. Small Head Hex Flange Bolts

J.I.S. B1189 • I.S.O. Class 10.9 • Zinc Plated

10mm Bolts Are Used With Auveco Hex Flange Nut 16470 On Import Car Exhaust Systems

Auveco Part No.	Size	Hex Size	Flange O.D.	Unit Pkg.
17315	M6-1.0 x 12mm	10mm	14mm	50
17316	M6-1.0 x 16mm	10mm	14mm	50
18807	M6-1.0 x 20mm	10mm	14mm	50
21048	M6-1.0 x 25mm	10mm	14mm	25
18808	M6-1.0 x 30mm	10mm	14mm	25
21049	M6-1.0 x 35mm	10mm	14mm	25
18809	M6-1.0 x 40mm	10mm	14mm	25
21050	M6-1.0 x 45mm	10mm	14mm	25
18980	M8-1.25 x 12mm	12mm	17.5mm	25
17387	M8-1.25 x 16mm	12mm	17.5mm	15
17388	M8-1.25 x 20mm	12mm	17.5mm	15
21051	M8-1.25 x 25mm	12mm	17.5mm	15
17389	M8-1.25 x 30mm	12mm	17.5mm	15
21052	M8-1.25 x 35mm	12mm	17.5mm	15
17390	M8-1.25 x 40mm	12mm	17.5mm	15
21053	M8-1.25 x 45mm	12mm	17.5mm	15
17188	M10-1.25 x 16mm	14mm	20mm	10
17189	M10-1.25 x 20mm	14mm	20mm	10
21054	M10-1.25 x 25mm	14mm	20mm	10
17190	M10-1.25 x 30mm	14mm	20mm	10
21055	M10-1.25 x 35mm	14mm	20mm	10
17191	M10-1.25 x 40mm	14mm	20mm	10
21056	M10-1.25 x 45mm	14mm	20mm	10

Torx® Round Washer Head Body Bolts

CA Point • Plated



Auveco Part No.	Size	Finish	Washer Head Dia.	Torx® Drive	Unit Pkg.
15807	M6-1.0 x 25mm	Zinc	18mm	T-30	50

METRIC ITEMS

Sec. 7



Metric Body Bolt Specification Chart

Auveco Part No.	Size	Length	Hex Size	Washer/Head O.D.	Type	Point Type	Finish	Unit Pkg.	Page No.
12232	M5-0.8	20mm	8mm	12mm	Hex Head Sems®	Dog Pt.	Phos.	50	51
20434	M6-1.0	12mm	10mm	12.5mm	Hex Head Sems®	C	Zinc & Yellow Dichromate	50	47
18177	M6-1.0	16mm	10mm	12.5mm	Hex Head Sems®	C	Zinc & Yellow Dichromate	50	47
15791	M6-1.0	16mm	10mm	17mm	Hex Head Sems®	C	Black Fluorocarbon	50	51
12064	M6-1.0	16mm	10mm	18.5mm	Hex Head Sems®	C	Zinc & Yellow	50	51
20176	M6-1.0	18.5mm	11mm	19mm	Hex Head Sems®	Dog Pt.	Phos.	50	51
18515	M6-1.0	20mm	T-30	13.5mm	Torx® Washer Head Drive	Dog Pt.	Black Organic	25	51
20435	M6-1.0	20mm	10mm	12.5mm	Hex Head Sems®	C	Zinc & Yellow Dichromate	50	47
12324	M6-1.0	20mm	10mm	13mm	Hex Washer Head	CA	Blk Polyseal	50	51
16826	M6-1.0	20mm	10mm	13mm	Slotted Hex Washer Head	CA	Zinc	50	51
12322	M6-1.0	20mm	10mm	17mm	Hex Head Sems®	C	Phos.	25	51
12693	M6-1.0	20mm	10mm	17mm	Hex Head Sems®	CA	Phos.	25	51
12067	M6-1.0	20mm	10mm	17mm	Hex Head Sems®	C	Phos.	50	51
19101	M6-1.0	20mm	T-30	18mm	Torx® Button Head Drive	Dog Pt.	Black Organic	15	51
13617	M6-1.0	20mm	10mm	24mm	Hex Head Sems®	CA	Phos.	50	51
12160	M6-1.0	22mm	8mm	19mm	High Hex Head Sems®	Dog Pt.	Phos.	25	51
15778	M6-1.0	22.5mm	8mm	19mm	Hex Head Sems®	Dog Pt.	Zinc	50	51
16757	M6-1.0	25mm	10mm	11mm	Hex Head Sems® & 12mm Split Wave Washer & Flat Washer	C	Zinc & Yellow Dichromate	25	47
13715	M6-1.0	25mm	10mm	13mm	Hex Washer Head	CA	Phos.	50	51
12338	M6-1.0	25mm	8mm	13mm	Hex Washer Head	C	Phos.	50	52
15807	M6-1.0	25mm	T-30	18mm	Torx® Round Washer Head Drive	CA	Zinc	50	48
12065	M6-1.0	25mm	10mm	17mm	Hex Head Sems®	CA	Phos.	50	52
15788	M6-1.0	25mm	10mm	17mm	Hex Head Sems®	CA	Zinc	50	52
19455	M6-1.0	25mm	10mm	19mm	Hex Head Sems®	Dog Pt.	Phos.	25	52
12066	M6-1.0	25mm	10mm	24mm	Hex Head Sems®	CA	Phos.	50	52
12323	M6-1.0	25mm	10mm	24mm	Hex Head Sems®	CA	Blk Polyseal	25	52
14947	M6-1.0	26mm	T-30	16mm	Pan Head Torx® Sems® Drive	Dog Pt.	Chrome	25	52
15757	M6-1.0	27mm	8mm	19mm	Hex Head Sems®	Dog Pt.	Phos.	50	52
15779	M6-1.0	28mm	8mm	19mm	Hex Head Sems®	Dog Pt.	Blk Zinc Phos.	50	52
12335	M6-1.0	28mm	8mm	19mm	Hex Head Sems®	Dog Pt.	Zinc & Yellow	25	52
16893	M6-1.0	28mm	8mm	25mm	Hex Head Sems®	Dog Pt.	Phos.	25	52
16751	M6-1.0	30mm	10mm	11mm	Hex Head Sems® & 12mm Split Wave Washer	C	Zinc & Yellow Dichromate	25	47
15818	M6-1.0	30mm	10mm	19mm	Hex Head Sems®	Dog Pt.	Phos.	50	52
20261	M6-1.0	30mm	10mm	20mm	Hex Head Sems®	CA	Phos.	25	52
13618	M6-1.0	30mm	10mm	24mm	Hex Head Sems®	CA	Phos.	50	52
16758	M6-1.0	30mm	10mm	11mm	Hex Head Sems® & 12mm Split Wave Washer & Flat Washer	C	Zinc & Yellow Dichromate	25	47

(Continued On Next Page)



Auveco Part No.	Size	Length	Hex Size	Washer/ Head O.D.	Type	Point Type	Finish	Unit Pkg.	Page No.
18180	M6-1.0	30mm	10mm	12.5mm	Hex Head Sems®	C	Zinc & Yellow Dichromate	50	47
18416	M6-1.0	35mm	10mm	17mm	Hex Head Sems®	CA	Blk Phos.	50	52
11633	M6.3-1.0	20mm	10mm	17mm	Hex Head Sems®	CA	Phos.	25	52
11935	M6.3-1.0	25mm	10mm	17mm	Hex Head Sems®	CA	Zinc	25	53
11638	M8-1.25	16mm	13mm	18mm	Hex Washer Head With Serrations Under The Head	Dog Pt.	Phos.	25	53
13704	M8-1.25	20mm	13mm	24mm	Hex Head Sems®	CA	Phos.	25	53
16753	M8-1.25	25mm	13mm	14mm	Hex Head Sems® Split Wave Washer	C	Zinc & Yellow Dichromate	25	47
16760	M8-1.25	25mm	13mm	14mm	Hex Head Sems® & 17mm Split Wave Washer & Flat Washer	C	Zinc & Yellow Dichromate	25	47
16361	M8-1.25	25mm	10mm	15mm	Hex Washer Head	Dog Pt.	Phos.	50	53
12336	M8-1.25	25mm	13mm	17mm	Hex Washer Head	CA	Blk Polyseal	25	53
15790	M8-1.25	25mm	13mm	17mm	Hex Head Sems®	CA	Phos.	50	53
11639	M8-1.25	25mm	13mm	17mm	Hex Washer Head	CA	Phos.	25	53
13613	M8-1.25	25mm	13mm	24mm	Hex Head Sems®	CA	Phos.	25	53
16754	M8-1.25	30mm	13mm	14mm	Hex Head Sems® Split Wave Washer	C	Zinc & Yellow Dichromate	25	47
16761	M8-1.25	30mm	13mm	14mm	Hex Head Sems® & 17mm Split Wave Washer & Flat Washer	C	Zinc & Yellow Dichromate	25	47
12348	M8-1.25	30mm	13mm	17mm	Hex Washer Head	CA	Phos.	25	53
11640	M8-1.25	30mm	13mm	17mm	Hex Washer Head	CA	Zinc Organic	25	53
13614	M8-1.25	30mm	13mm	24mm	Hex Head Sems®	CA	Phos.	25	53
15780	M8-1.25	33mm	10mm	22mm	Hex Head Sems®	Dog Pt.	Phos.	50	53
12343	M8-1.25	35mm	13mm	17mm	Hex Washer Head	CA	Phos.	25	53
13705	M8-1.25	35mm	13mm	24mm	Hex Head Sems®	CA	Phos.	25	53
16755	M8-1.25	40mm	13mm	14mm	Hex Head Sems® Split Wave Washer	C	Zinc & Yellow Dichromate	25	47
16762	M8-1.25	40mm	13mm	14mm	Hex Head Sems® & 17mm Split Wave Washer & Flat Washer	C	Zinc & Yellow Dichromate	25	47
16931	M8-1.25	42mm	10mm	22mm	Hex Head Sems®	Dog Pt.	Phos.	25	53
18187	M8-1.25	45mm	12mm	17mm	Hex Head Sems®	C	Zinc & Yellow Dichromate	25	47
12329	M10-1.50	25mm	13mm	20mm	Hex Washer Head	C	Phos.	25	54
13619	M10-1.50	30mm	15mm	29mm	Hex Head Sems®	CA	Phos.	10	54
12327	M10-1.50	33mm	13mm	20mm	Hex Washer Head	Dog Pt.	Phos.	25	54
21039	M10-1.50	35mm	15mm	22mm	Hex Washer Head Sems® & 25mm	Dog Pt.	Zinc Organic	10	54
11641	M10-1.50	40mm	15mm	29mm	Hex Head Sems®	CA	Phos.	25	54
13620	M10-1.50	45mm	15mm	30mm	Hex Head Sems®	CA	Phos.	10	54

METRIC ITEMS

Sec. 7



12232
(6100539)
Phosphate
M5-0.8 x 20mm
Hex Head Sems®
Thread Cutting Screw
With Dog Point
12mm (1/2") O.D. Washer
8mm Hex
Chrysler
UNIT PACKAGE: 50



20176
(N800510-S100)
Phosphate
M6-1.0 x 18.5mm
Hex Head Sems®
With Dog Point
Class 9.8
19mm (3/4") Washer O.D.
11mm Hex
Replaces Auveco 15719
Ford
UNIT PACKAGE: 50



12322
(11503815, 11508023)
Phosphate
M6-1.0 x 20mm
Hex Head Sems®
Class 9.8
17mm (21/32") Wshr O.D.
10mm Hex
GM
UNIT PACKAGE: 25



13617
(11503941)
Phosphate
M6-1.0 x 20mm
Hex Head Sems®
Class 9.8; 10mm Hex
24mm (15/16") Wshr O.D.
GM
UNIT PACKAGE: 50

**Please
Order In
Unit Package
Quantities
Not Number
Of Pieces**



18515
(21094240)
Black
500 Hr. Salt Spray
M6-1.0 x 20mm
Torx® Washer Head
With Dog Point & Sealant
On Threads
13.5 Washer Head O.D.
T-30 Drive
Front & Rear Door Lock
GM Saturn
UNIT PACKAGE: 25



12693
(11502941, 11506174)
Phosphate
M6-1.0 x 20mm
Hex Head Sems®
Class 9.8
17mm (21/32")
Washer O.D.
10mm Hex
GM
UNIT PACKAGE: 25



15778
(N606676-S36)
Zinc
M6-1.0 x 22.5mm
Hex Head Sems®
With Dog Point
Class 9.8
19mm (3/4") Washer O.D.
8mm Hex
Ford
UNIT PACKAGE: 50



15791
(11508930)
Black
Fluorocarbon
M6-1.0 x 16mm
Hex Head Sems®
Class 9.8; 10mm Hex
17mm (21/32") Wshr O.D.
GM
UNIT PACKAGE: 50



12324
(11503800)
Black Polyseal
M6-1.0 x 20mm
Hex Washer Head
Class 9.8
13mm (1/2") Wshr Hd. O.D.
10mm Hex
GM
UNIT PACKAGE: 50



12067
(11504570, 11509816,
11514623)
Phosphate
M6-1.0 x 20mm
Hex Head Sems®
Class 9.8; 10mm Hex
17mm (21/32") Wshr O.D.
GM
UNIT PACKAGE: 50



12160
(N606676-S2, S100)
Phosphate
M6-1.0 x 22mm
High Hex Head Sems®
With Dog Point
Class 9.8; 8mm Hex
19mm (3/4") Washer O.D.
Ford
UNIT PACKAGE: 25



12064
(11503812)
Zinc & Yellow
M6-1.0 x 16mm
Hex Head Sems®
Class 9.8; 10mm Hex
18.5mm (47/64") Wshr O.D.
GM
UNIT PACKAGE: 50



16826
(Chry: 34201287;
AMC: 8934201287)
Zinc
M6-1.0 x 20mm
Slotted Hex Washer Head
License Plate Screw
13mm (1/2") Wshr Hd. O.D.
10mm Hex
Chrysler, Honda & AMC
UNIT PACKAGE: 50



19101
(21075387)
Black Organic
M6-1.0 x 20mm
Torx® Button Head
18mm Washer O.D.
T-30 Drive
Fender To
Upper Engine Rail
GM Saturn 1991-On
UNIT PACKAGE: 15



13715
(11503958)
Phosphate
M6-1.0 x 25mm
Hex Washer Head
Class 9.8; 10mm Hex
13mm (1/2")
Washer Hd. O.D.
GM
UNIT PACKAGE: 50

Sec. 7**METRIC ITEMS****12338**(N605774-S2)
PhosphateM6-1.0 x 25mm
Hex Washer Head
Class 9.8
13mm (1/2")
Washer Hd. O.D.
8mm Hex
Ford

UNIT PACKAGE: 50

**12066**(11503982)
PhosphateM6-1.0 x 25mm
Hex Head Sems®
Class 9.8; 10mm Hex
24mm (15/16") Wshr O.D.
GM

UNIT PACKAGE: 50

**15779**(N606677-S43B)
Black Zinc PhosphateM6-1.0 x 28mm
Hex Hd Sems® w/ Dog Pt
19mm (3/4") Washer O.D.
8mm Hex
Ford

UNIT PACKAGE: 50

**20261**(10287379)
PhosphateM6-1.0 x 30mm
Hex Head Sems®
Class 9.8; 10mm Hex
20mm (13/16")
Washer O.D.
GM

UNIT PACKAGE: 25

**12065**(11503834,
20351035)
PhosphateM6-1.0 x 25mm
Hex Head Sems®
Class 9.8; 10mm Hex
17mm (21/32") Wshr O.D.
GM

UNIT PACKAGE: 50

**12323**(11504493)
Black PolysealM6-1.0 x 25mm
Hex Head Sems®
Class 9.8; 10mm Hex
24mm (15/16") Wshr O.D.
GM

UNIT PACKAGE: 25

**12335**(N606677-S36)
Zinc & YellowM6-1.0 x 28mm
Hex Hd Sems® w/ Dog Pt
Class 9.8; 8mm Hex
19mm (3/4") Washer O.D.
Ford

UNIT PACKAGE: 25

**13618**(11503825)
PhosphateM6-1.0 x 30mm
Hex Head Sems®
Class 9.8; 10mm Hex
24mm (15/16")
Washer O.D.
GM

UNIT PACKAGE: 50

**15788**(11503833)
ZincM6-1.0 x 25mm
Hex Head Sems®
17mm (21/32") Wshr O.D.
10mm Hex
GM

UNIT PACKAGE: 50

**14947**(N800928-S45,
N806345-S47, -S433
N801851-S45)
ChromeM6-1.0 x 26mm
Pan Head Internal
Torx® Drive Sems®
14mm Head Diameter
16mm (5/8") Washer O.D.
T-30 Drive
Truck Mirror Mounting
Bracket Bolt
Ford Trucks

UNIT PACKAGE: 25

**16893**(N800947-S,
AB-181-GG)
PhosphateM6-1.0 x 28mm
Hex Head Sems®
With Dog Point
Class 9.8
25mm (1") Washer O.D.
8mm Hex
Ford

UNIT PACKAGE: 25

**18416**(11505044)
Black PhosphateM6-1.0 x 35mm
Hex Head Sems®
Class 9.8
17mm (21/32")
Washer O.D.
10mm Hex
GM

UNIT PACKAGE: 50

**19455**(6100567)
PhosphateM6-1.0 x 25mm
Hex Head Sems®
w/ Dog Point
10mm Hex
19mm (3/4") Washer O.D.
Grille, Fender,
Hood Prop & Latch
Chrysler

UNIT PACKAGE: 25

**15757**

Phosphate

M6-1.0 x 27mm
Hex Hd Sems® w/ Dog Pt
Class 9.8; 8mm Hex
19mm (3/4") Washer O.D.

UNIT PACKAGE: 50

**15818**(6100568)
PhosphateM6-1.0 x 30mm
Hex Head Sems®
With Dog Point
Class 9.8; 10mm Hex
19mm (3/4") Washer O.D.
Chrysler

UNIT PACKAGE: 50

**11633**(11501105)
PhosphateM6-3-1.0 x 20mm
Hex Head Sems®
Class 9.8; 10mm Hex
17mm (21/32")
Wshr O.D.
GM

UNIT PACKAGE: 25

METRIC ITEMS



11935
(11502790)
Zinc
M6.3-1.0 x 25mm
Hex Head Sems®
Class 9.8; 10mm Hex
17mm (21/32") Wshr O.D.
GM
UNIT PACKAGE: 25



16361
(N801078-S58)
Phosphate
M8-1.25 x 25mm
Hex Washer Head
With Dog Point
15mm (19/32")
Washer Head O.D.
10mm Hex
Ford
UNIT PACKAGE: 50



12348
(11500971)
Phosphate
M8-1.25 x 30mm
Hex Washer Head
Class 9.8; 13mm Hex
17mm (21/32")
Washer Head O.D.
GM
UNIT PACKAGE: 25



12343
(11504982)
Phosphate
M8-1.25 x 35mm
Hex Washer Head
Class 9.8; 13mm Hex
17mm (21/32")
Washer Hd. O.D.
GM
UNIT PACKAGE: 25



11638
(362029m 11509589)
Phosphate
M8-1.25 x 16mm
Hex Washer Head
w/Serrations Under The
Head & Dog Point
18mm (23/32")
Washer Hd. O.D.
13mm Hex
GM
UNIT PACKAGE: 25



12336
(11503632)
Black Polyseal
M8-1.25 x 25mm
Hex Washer Head
Class 9.8; 13mm Hex
17mm (21/32")
Washer Head O.D.
GM
UNIT PACKAGE: 25



11640
(549790, 11500971)
Zinc Organic
M8-1.25 x 30mm
Hex Washer Head
Class 9.8; 13mm Hex
17mm (21/32")
Washer Hd. O.D.
GM
UNIT PACKAGE: 25



13705
(11503668)
Phosphate
M8-1.25 x 35mm
Hex Head Sems®
Class 9.8; 13mm Hex
24mm (15/16")
Washer O.D.
GM
UNIT PACKAGE: 25



13704
Phosphate
M8-1.25 x 20mm
Hex Head Sems®
Class 9.8; 13mm Hex
24mm (15/16") Wshr O.D.
UNIT PACKAGE: 25



15790
(11505326)
Phosphate
M8-1.25 x 25mm
Hex Head Sems®
Class 9.8; 13mm Hex
17mm (21/32")
Wshr O.D.
GM
UNIT PACKAGE: 50



13614
(11501188)
Phosphate
M8-1.25 x 30mm
Hex Head Sems®
Class 9.8; 13mm Hex
24mm (15/16") Wshr O.D.
GM
UNIT PACKAGE: 25



16931
(N606692-S2,
AB-187EH)
Phosphate
M8-1.25 x 42mm
Hex Hd. Sems®
With Dog Pt.
22mm (7/8")
Washer O.D.
Class 9.8
10mm Hex
Ford
UNIT PACKAGE: 25



11639
(11502605,
11502624, 11509511)
Phosphate
M8-1.25 x 25mm
Hex Washer Head
Class 9.8; 13mm Hex
17mm (21/32")
Wshr Hd OD
GM
UNIT PACKAGE: 25



13613
(11503619)
Phosphate
M8-1.25 x 25mm
Hex Head Sems®
Class 9.8; 13mm Hex
24mm (15/16") Wshr O.D.
GM
UNIT PACKAGE: 25



15780
(N606690-S2)
Phosphate
M8-1.25 x 33mm
Hex Head Sems®
With Dog Point
Class 9.8; 10mm Hex
22mm (7/8") Washer O.D.
Ford
UNIT PACKAGE: 50

For the most recent information on new items available from Auveco, refer to the "Hot New Items" section of the Auveco website (www.auveco.com)

Sec. 7

METRIC ITEMS



12329

(N605800-S2)
Phosphate

M10-1.50 x 25mm
Hex Washer Head
Class 9.8; 13mm Hex
20mm (13/16")
Washer Head O.D.
Ford

UNIT PACKAGE: 25



12327

(N605920-S2)
Phosphate

M10-1.50 x 33mm
Hex Washer Head
With Dog Point
Class 9.8; 13mm Hex
20mm (13/16")
Washer Hd. O.D.
Ford

UNIT PACKAGE: 25



11641

(11501193)
Phosphate

M10-1.50 x 40mm
Hex Head Sems®
Class 9.8
15mm Hex
29mm (1-5/32")
Washer O.D.
GM

UNIT PACKAGE: 25



13619

Phosphate

M10-1.50 x 30mm
Hex Head Sems®
Class 9.8
29mm (1-1/8")
Wshr O.D.
15mm Hex

UNIT PACKAGE: 10



21039

(11516845)
Zinc Organic

M10-1.5 x 35mm
Hex Washer Head Sems®
15mm Hex
25mm (1") Washer O.D.
22mm (7/8")
Washer Head O.D.
GM Front & Rear Bumpers,
Dash, Doors & General
Purpose
1997 - On

UNIT PACKAGE: 10



13620

Phosphate

M10-1.50 x 45mm
Hex Head Sems®
Class 9.8
15mm Hex
30mm (1-3/16")
Washer O.D.

UNIT PACKAGE: 10

Metric Special Tapping Screw Specification Chart

Auveco Part No.	Size	Length	Hex Size	Washer/Head O.D.	Type	Point Type	Finish	Unit Pkg.	Page No.
12062	M4.2-1.41 (#8)	14mm (13/32")	10mm	11mm (7/16")	Phillips Washer Head, Pozi-Drive	AB	Black Oxide	100	58
15941	M4.2-1.41 (#8)	12mm (15/32")	12mm	9.5mm (3/8")	Phillips Truss Head	AB	Black Oxide	10	58
16596	M4.2-1.41 (#8)	12mm (15/32")	12mm	9.5mm (3/8")	Phillips Truss Head	AB	Black Oxide	100	58
12739	M4.2-1.41 (#8)	12mm (15/32")	12mm	10mm (25/64")	Phillips Washer Head, Pozi-Drive	AB	Chrome	100	58
12059	M4.2-1.41 (#8)	13mm (33/64")	13mm	11mm (7/16")	Phillips Washer Head	AB	Zinc	100	58
12061	M4.2-1.41 (#8)	13mm (33/64")	13mm	8.5mm (11/32")	Phillips Round Washer Head, Pozi-Drive	AB	Black Oxide	100	58
13712	M4.2-1.41 (#8)	13mm (33/64")	13mm	11mm (7/16")	Phillips Washer Head	AB	Black Zinc	50	58
12740	M4.2-1.41 (#8)	13mm (33/64")	13mm	7mm (15/32")	Hex Head Sems®	AB	Phosphate	100	58
12743	M4.2-1.41 (#8)	13mm (33/64")	13mm	7mm (11/32")	Hex Washer Head	AB	Zinc	100	59

Metric Special Tapping Screw Specification Chart

Auveco Part No.	Size	Length	Hex Size	Washer/ Head O.D.	Type	Point Type	Finish	Unit Pkg.	Page No.
15721	M4.2-1.41 (#8)	13mm (33/64")	7mm	16mm (5/8")	Hex Head Sems®	AB	Phosphate	50	59
18781	M4.2-1.41 (#8)	14mm (9/16")	7mm	8mm (5/16")	Hex Head Sems®	AB	Phosphate	50	59
21122	M4.2-1.41 (#8)	14mm (9/16")		11mm (7/16")	Phillips Washer Head, Pozi-Drive	Teks®	Chrome	50	59
18817	M4.2-1.41 (#8)	16mm (5/8")		11mm (7/16")	Phillips Round Washer Head, Pozi-Drive	Teks®	Black Zinc	100	59
16720	M4.2-1.41 (#8)	16mm (5/8")		9.5mm (3/8")	Phillips Truss Head	AB	Black Oxide	100	59
12741	M4.2-1.41 (#8)	16mm (5/8")	7mm	12mm (15/32")	Hex Head Sems®	AB	Phosphate	100	59
18261	M4.2-1.41 (#8)	16mm (5/8")	7mm	12mm (15/32")	Hex Washer Head Sems®	Teks®	Phosphate	50	59
11937	M4.2-1.41 (#8)	20mm (25/32")		7mm (9/32")	Torx® Oval Head	AB	Chrome	50	57
11938	M4.2-1.41 (#8)	20mm (25/32")		7mm (9/32")	Torx® Oval Head	AB	Black Oxide	50	57
11944	M4.2-1.41 (#8)	20mm (25/32")		8mm (5/16")	Torx® Pan Head	AB	Black Oxide	50	57
12060	M4.2-1.41 (#8)	20mm (25/32")		11mm (7/16")	Phillips Washer Head	AB	Black Oxide	100	59
12097	M4.2-1.41 (#8)	20mm (25/32")		12mm (15/32")	Phillips Pan Head Sems®	AB	Chrome	50	59
12738	M4.2-1.41 (#8)	20mm (25/32")	7mm	12mm (15/32")	Hex Washer Head Sems®	AB	Phosphate	50	59
12742	M4.2-1.41 (#8)	20mm (25/32")	7mm	12mm (15/32")	Hex Head Sems®	AB	Phosphate	100	59
15373	M4.2-1.41 (#8)	20mm (25/32")	7mm	16mm (5/8")	Hex Head Sems®	AB	Phosphate	50	59
20271	M4.2-1.41 (#8)	20mm (25/32")		16mm (5/8")	Phillips Pan Head Sems®	AB	Phosphate	50	59
20476	M4.2-1.41 (#8)	20mm (25/32")	7mm	17mm (11/16")	Hex Washer Head Sems®	Teks®	Phosphate	50	59
19278	M4.2-1.41 (#8)	20mm (25/32")	7mm	20mm (25/32")	Hex Head Sems®	AB	Black Phos	50	59
15775	M4.2-1.41 (#8)	20mm (25/32")	7mm	12mm (15/32")	Hex Head Sems®	Teks®	Phosphate	50	60
14046	M4.2-1.41 (#8)	25mm (1")		8mm (5/16")	Torx® Pan Head	AB	Black Oxide	50	57
14049	M4.2-1.41 (#8)	25mm (1")		8mm (5/16")	Torx® Pan Head	AB	Chrome	50	57
14053	M4.2-1.41 (#8)	25mm (1")		7mm (9/32")	Torx® Oval Head	AB	Black Oxide	50	57
19006	M4.2-1.41 (#8)	25mm (1")		11mm (7/16")	Round Washer Head, Pozi-Drive	Teks®	Phosphate	100	60
20382	M4.2-1.41 (#8)	25mm (1")	T-15 Drive	12mm (15/32")	Torx® Pan Head Sems®	AB	Black Zinc	50	60
18336	M4.2-1.41 (#8)	25mm (1")	7mm	12mm (15/32")	Hex Head Sems®	AB	Black Phos	100	60

(Continued On Next Page)

Sec. 7

Metric Special Tapping Screw Specification Chart

Auveco Part No.	Size	Length	Hex Size	Washer/ Head O.D.	Type	Point Type	Finish	Unit Pkg.	Page No.
19653	M4.2-1.41 (#8)	30mm (1-3/16")	7mm	17mm (11/16")	Hex Head Sems®	AB	Black Phos	15	60
11945	M4.2-1.41 (#8)	35mm (1-3/8")		8mm (5/16")	Torx® Pan Head	AB	Chrome	25	57
14047	M4.2-1.41 (#8)	35mm (1-3/8")		7mm (9/32")	Torx® Oval Head	AB	Black Oxide	50	57
14952	M4.2-1.41 (#8)	55mm (2-3/16")		8mm (5/16")	Torx® Pan Head	AB	Black Oxide	50	57
18340	M4.8-1.61 (#10)	15mm (19/32")		14mm (9/16")	Phillips Truss Head	AB	Black Phos	50	60
17459	M4.8-1.61 (#10)	16mm (5/8")		11mm (7/16")	Phillips Truss Head	AB	Black Oxide	100	60
20259	M4.8-1.61 (#10)	19mm (3/4")		16mm (5/8")	Phillips Truss Head Sems®	AB	Black E Coat	25	60
16589	M4.8-1.61 (#10)	19mm (3/4")	8mm	15mm (19/32")	Hex Head Sems®	AB	Zinc & Yellow Dichromate	50	30
20455	M4.8-2.12 (#10)	20mm (25/32")		14mm (9/16")	Phillips Truss Head	AB	Black Phos	50	60
19251	M5-1.59	16mm	8mm	16mm	Phillips Hex Head Sems®	A	Black Zinc	50	60
17461	M5.5-1.81 (#12)	18mm (45/64")	8mm	15mm (19/32")	Hex Head Sems®	AB	Zinc & Yellow Dichromate	50	60
21541	M5.5 (#12)	20mm (25/32")	T-20 Drive	15mm (19/32")	Torx® Truss Head	AB	Black Zinc	25	60
19718	M6.3-1.81 (#14)	16mm (5/8")		T-30 Drive	Torx® Oval Head	AB	Mechanical Zinc & Yellow Chromate	50	60
19170	M6.3-1.81 (#14)	16mm (5/8")		15mm (19/32")	Phillips Truss Head	AB	Black Phos	50	60
15776	M6.3-1.81 (#14)	16mm (5/8")	8mm	16mm (5/8")	Hex Head Sems®	AB	Phosphate	50	60
12057	M6.3-1.81 (#14)	16mm (5/8")	10mm	17mm (11/16")	Hex Head Sems®	AB	Phosphate	50	61
15962	M6.3-1.81 (#14)	18mm (23/32")	10mm	22mm (7/8")	Hex Head Sems®	AB	Zinc & Yellow Dichromate	25	61
13019	M6.3-1.81 (#14)	19mm (3/4")	8mm	11.5mm (29/64")	Hex Washer Head	AB	Phosphate	50	61
20556	M6.3-1.81 (#14)	20mm (25/32")	10mm	16mm (5/8")	Phillips Hex Head Sems®	AB	Black Zinc	50	61
12351	M6.3-1.81 (#14)	20mm (25/32")	10mm	17mm (11/16")	Hex Washer Head Sems®	AB	Black Polyseal	50	61
16828	M6.3-1.81 (#14)	20mm (25/32")	10mm	18mm (45/64")	Hex Head Sems®	AB	Zinc & Yellow Dichromate	25	61
20557	M6.3-1.81 (#14)	20mm (25/32")	10mm	20mm (25/32")	Phillips Hex Head Sems®	AB	Black Zinc	50	61

Metric Special Tapping Screw Specification Chart

Sec. 7

Auveco Part No.	Size	Length	Hex Size	Washer/ Head O.D.	Type	Point Type	Finish	Unit Pkg.	Page No.
12339	M6.3-1.81 (#14)	25mm (1")	10mm	17mm (11/16")	Hex Head Sems®	AB	Phosphate	50	61
12354	M6.3-1.81 (#14)	30mm (1-3/16")	10mm	17mm (11/16")	Hex Head Sems®	AB	Phosphate	50	61
12068	M6.3-1.81 (#14)	30mm (1-3/16")	10mm	24mm (15/16")	Hex Head Sems®	AB	Phosphate	50	61
19417	M7.5	35mm (1-3/8")	#3 Sq Drive	22mm (7/8")	Nylon Square Drive Truss Head	AB	Black Nylon	15	61
12350	M8-2.12 (5/16"-12)	20mm (25/32")	13mm	16mm (5/8")	Hex Washer Head	AB	Phosphate	25	61
21517	M9.5	46mm (1-13/16")	#3 Sq Drive	22mm (7/8")	Nylon Square Drive Truss Head	AB	Black Nylon	25	61
20970	M14	34mm (1-11/32")	#3 Sq Drive	22mm (7/8")	Nylon Square Drive Truss Head	AB	Black Nylon	25	62

METRIC SPECIAL TAPPING SCREWS



Metric Torx® Head Tapping Screws 300 Series Stainless Steel

Auveco Part No.	Size	Head Style	GM Number	Finish	Unit Pkg.
11937	M4.2-1.41 x 20mm	M7 Oval	11504069	Chrome	50
11938	M4.2-1.41 x 20mm	M7 Oval	11504659	Black Ox	50
11944	M4.2-1.41 x 20mm	M8 Pan	11504655	Black Ox	50
14046	M4.2-1.41 x 25mm	M8 Pan	11504662	Black Ox	50
14049	M4.2-1.41 x 25mm	M8 Pan	11504661	Chrome	50
14053	M4.2-1.41 x 25mm	M7 Oval	11505182	Black Ox	50
11945	M4.2-1.41 x 35mm	M8 Pan	11504663	Chrome	25
14047	M4.2-1.41 x 35mm	M7 Oval	11504785	Black Ox	50
14952*	M4.2-1.41 x 55mm	M8 Pan	14083901	Black Ox	50

* Not Fully Threaded



Metric Torx® Insert Bits For Torx® Screws

1" Shank

Auveco Part No.	Bit Size	For Screw Size	Unit Pkg.
12472	T-10	No. 4	1
11949	T-15	No. 6, M4.2	1
11950	T-20	No. 8, M4.2	1
12103	T-25	No. 10	1
14913	T-27	No. 12, 1/4"	1
12104	T-30	1/4", M6	1
12105	T-40	5/16", M8	1
14916*	T-55	1/2", 9/16", 5/8"	1

* 1-1/4" Shank



12062

(11501903)
Black Oxide

M4.2-1.41 x 10mm
(#8 x 13/32")
Phillips Washer Head
Pozi-Drive
11mm (7/16") Washer Hd. O.D.
GM

UNIT PACKAGE: 100



12059

(11501883)
Zinc

M4.2-1.41 x 13mm
(#8 x 33/64")
Phillips Washer Head
Pozi-Drive
11mm (7/16") Washer Hd. O.D.
GM

UNIT PACKAGE: 100



15941

Black Oxide

M4.2-1.41 x 12mm
(#8 x 15/32")
Phillips Truss Head
9.5mm (3/8") Hd. Diameter
Japanese Imports

UNIT PACKAGE: 10

16596

Same As 15941
Except For Unit Package

UNIT PACKAGE: 100



12061

(11501896)
Black Oxide

M4.2-1.41 x 13mm
(#8 x 33/64")
Phillips Round Washer Hd
Pozi-Drive
8.5mm (11/32")
Washer Hd. O.D.
GM

UNIT PACKAGE: 100



12739

(11501794)
Chrome

M4.2-1.41 x 12mm
(#8x 15/32")
Phillips Washer Head
Pozi-Drive
10mm (25/64") Washer Hd. O.D.
GM

UNIT PACKAGE: 100



13712

(11505104)
Black Zinc

M4.2-1.41 x 13mm
(#8 x 33/64")
Phillips Washer Head
11mm (7/16")
Washer Hd. O.D.
GM

UNIT PACKAGE: 50



12740

(11503394)
Phosphate

M4.2-1.41 x 13mm
(#8 x 33/64")
Hex Head Sems®
12mm (15/32") Wshr O.D.
7mm Hex
GM

UNIT PACKAGE: 100

METRIC ITEMS

Sec. 7



12743
(11502843)
Zinc
M4.2-1.41 x 13mm
(#8 x 33/64")
Hex Washer Head
9mm (11/32") Washer O.D.
7mm Hex
GM
UNIT PACKAGE: 100



15721
(11504010)
Phosphate
M4.2-1.41 x 13mm
(#8 x 19/32")
Indented Hex Head Sems®
16mm (5/8") Washer O.D.
7mm Hex
GM
UNIT PACKAGE: 50



21122
Chrome
M4.2-1.41 x 14mm
(#8 x 9/16")
Phillips Pozi Drive
Washer Head Tek®
11mm (7/16")
Washer Head O.D.
UNIT PACKAGE: 50



18781
(11515566)
Phosphate
M4.2-1.41 x 14mm
(#8 x 9/16")
Hex Head Sems®
8mm (5/16") Washer O.D.
7mm Hex
GM
UNIT PACKAGE: 50



18817
(1746408)
Black Zinc
M4.2-1.41 x 16mm
(#8 x 41/64")
Phillips Round Washer Hd.
w/Serrations Under The Hd.
Pozi-Drive
With Tek® Point
11mm (7/16")
Washer Head O.D.
Moulding, Trim &
General Purpose
GM

UNIT PACKAGE: 100



16720
Black Oxide
M4.2-1.41 x 16mm
(#8 x 5/8")
Phillips Truss Head
9.5mm (3/8") Head Dia.
Honda
UNIT PACKAGE: 100



12741
(11503395)
Phosphate
M4.2-1.41 x 16mm
(#8 x 5/8")
Hex Head Sems®
12mm (15/32") Wshr O.D.
7mm Hex
GM
UNIT PACKAGE: 100



18261
(11503578,
11503785)
Phosphate
M4.2-1.41 x 16mm
(#8 x 5/8")
Hex Washer Head Sems®
With Tek® Point
12mm (1/2") Washer O.D.
7mm Hex
GM
UNIT PACKAGE: 50



12060
(11501884)
Black Oxide
M4.2-1.41 x 20mm
(#8 x 25/32")
Phillips Washer Head
11mm (7/16") Wshr Hd. O.D.
GM
UNIT PACKAGE: 100



12097
(9420052,
11502483,
11503503)
Chrome
M4.2-1.41 x 20mm
(#8 x 25/32")
Phillips Pan Head Sems®
Pozi-Drive
12mm (1/2") Washer O.D.
GM
UNIT PACKAGE: 50



12738
(11504056, 11513801)
Phosphate
M4.2-1.41 x 20mm
(#8 x 25/32")
Hex Washer Head Sems®
12mm (1/2") Washer O.D.
7mm Hex
Radiator & Grille
GM
UNIT PACKAGE: 50



12742
(11503396,
11503483)
Phosphate
M4.2-1.41 x 20mm
(#8 x 25/32")
Hex Head Sems®
12mm (1/2") Washer O.D.
7mm Hex
Front End & Air Cond.
GM
UNIT PACKAGE: 100



15373
(11503892,
11500434)
Phosphate
M4.2-1.41 x 20mm
(#8 x 25/32")
Hex Head Sems®
16mm (5/8") Washer O.D.
7mm Hex; GM
UNIT PACKAGE: 50



20271
(N801603-S2)
Phosphate
M4.2-1.41 x 20mm
(#8 x 25/32")
Phillips Pan Head Sems®
16mm (5/8") Washer O.D.
Ford
UNIT PACKAGE: 50



20476
Phosphate
M4.2-1.41 x 20mm
(#8 x 25/32")
Hex Washer Head
Sems® Tek®
17mm (11/16")
Washer O.D.
7mm Hex
General Purpose
UNIT PACKAGE: 50



19278
(GM: 14090382;
Chrys: 6506161-AA)
Black Phosphate
M4.2-1.41 x 20mm
(#8 x 25/32")
Hex Head Sems®
20mm Washer O.D.
7mm Hex
GM
UNIT PACKAGE: 50

METRIC ITEMS



15775

Phosphate

M4.2-1.41 x 20mm
 (#8 x 25/32")
 Hex Head Sems®
 With Teks® Point
 12mm (1/2") Washer O.D.
 7mm Hex

UNIT PACKAGE: 50



19653

(N81 1534-S61)
 Black Phosphate

M4.2-1.41 x 30mm
 (#8 x 1-3/16")
 Hex Head Sems®
 17mm (11/16")
 Washer O.D.
 7mm Hex
 Ford

UNIT PACKAGE: 15



20455

Black Phosphate

M4.8-2.12 x 20mm
 (#10 x 25/32")
 Phillips Truss Head
 14mm Head O.D.
 Imports

UNIT PACKAGE: 50



21541

(13144822)
 Black Zinc

M5.5 x 20mm
 (#12 x 25/32")
 Torx® Truss Head
 T-20 Drive
 15mm (19/32") Head O.D.

**Use With Auveco
 21539 & 21540**

GM 2011 - On
 Saab 2003 - On

UNIT PACKAGE: 25



19006

Phosphate

M4.2-1.41 x 25mm
 (#8 x 1")
 Round Washer Head
 Pozi-Drive
 With Teks® Point
 11mm (7/16")
 Washer Head O.D.
 General Purpose

UNIT PACKAGE: 100



18340

Black Phosphate

M4.8-1.61 x 15mm
 (#10 x 19/32")
 Phillips Truss Head
 14mm (9/16") Head O.D.
 Nissan Bumpers

UNIT PACKAGE: 50



19251

Black Zinc

M5-1.59 x 16mm
 Phillips Hex Head Sems®
 16mm Washer O.D.
 8mm Hex

UNIT PACKAGE: 50



19718

(6501220)
 Mechanical Zinc
 & Yellow Chromate

M6.3-1.81 x 16mm
 (#14 x 5/8")
 Torx® Drive Oval Head
 T-30 Drive

13mm (1/2") Head O.D.
 Door Latch Mounting
 Chrysler 1996-86

UNIT PACKAGE: 50



20382

(Not Available
 From O.E.M.)
 Black Zinc

M4.2-1.41 x 25mm
 (#8 x 1")
 Torx® Pan Head Sems®
 T-15 Drive
 12mm (1/2") Washer O.D.

UNIT PACKAGE: 50



17459

Black Oxide

M4.8-1.61 x 16mm
 (#10 x 5/8")
 Phillips Truss Head
 11mm (7/16") Head Dia.
 Imports

UNIT PACKAGE: 100



17461

Zinc & Yellow Dichromate

M5.5-1.81 x 18mm
 (#12 x 45/64")
 Hex Head Sems®
 15mm (19/32")
 Washer O.D.
 8mm Hex
 Imports

UNIT PACKAGE: 50



19170

Black Phosphate

M6.3-1.81 x 16mm
 (#14 x 5/8")
 Phillips Truss Head
 15mm (19/32") Head O.D.
 Japanese Imports

UNIT PACKAGE: 50



18336

Black Phosphate

M4.2-1.41 x 25mm
 (#8 x 1")
 Hex Head Sems®
 12mm (1/2") Washer O.D.
 7mm Hex

UNIT PACKAGE: 100



20259

(90114-SZ3-000,
 90114-SE0-000)
 Black E-Coat

M4.8-1.61 x 19mm
 (#10 x 3/4")
 Phillips Truss Head Sems®
 Washer O.D.: 16mm (5/8")
 Splash Shield &
 General Purpose
 Honda
 1986 - On

UNIT PACKAGE: 25



15776

(N800312-S2)
 Phosphate

M6.3-1.81 x 16mm
 (#14 x 5/8")
 Hex Head Sems®
 16mm (5/8") Washer O.D.
 8mm Hex
 Ford

UNIT PACKAGE: 50

METRIC ITEMS



12057
(11500994)
Phosphate

M6.3-1.81 x 16mm
(#14 x 5/8")
Hex Head Sems®
17mm (11/16") Washer O.D.
10mm Hex
GM

UNIT PACKAGE: 50



15962
Zinc & Yellow
Dichromate

M6.3-1.81 x 18mm
(#14 x 23/32")
Hex Head Sems®
22mm (7/8") Washer O.D.
10mm Hex
Honda, Nissan, Toyota

UNIT PACKAGE: 25



13019
(N610959-S2)
Phosphate

M6.3-1.81 x 19mm
(#14 x 3/4")
Hex Washer Head
11.5mm (29/64") Wshr O.D.
8mm Hex
Ford

UNIT PACKAGE: 50



20556
Black Zinc

M6.3-1.81 x 20mm
(#14 x 25/32")
Phillips Hex Head Sems®
16mm (5/8") Washer O.D.
10mm Hex
Imports

UNIT PACKAGE: 50



12351
(11505022)
Black Polyseal Finish

M6.3-1.81 x 20mm
(#14 x 25/32")
Hex Washer Head Sems®
17mm (11/16") Washer O.D.
10mm Hex
GM

UNIT PACKAGE: 50



16828
Zinc & Yellow Dichromate

M6.3-1.81 x 20mm
(#14 x 25/32")
Hex Head Sems®
18mm (45/64") Washer O.D.
10mm Hex
Honda, Nissan, & Toyota

UNIT PACKAGE: 25



20557
Black Zinc

M6.3-1.81 x 20mm
(#14 x 25/32")
Phillips Hex Head Sems®
20mm (25/32") Washer O.D.
10mm Hex
Imports

UNIT PACKAGE: 50



12339
(11500996, 11505023)
Phosphate

M6.3-1.81 x 25mm
(#14 x 1")
Hex Head Sems®
17mm (21/32") Washer O.D.
10mm Hex
GM

UNIT PACKAGE: 50



12354
(11500997)
Phosphate

M6.3-1.81 x 30mm
(#14 x 1-3/16")
Hex Head Sems®
17mm (21/32") Washer O.D.
10mm Hex
GM

UNIT PACKAGE: 50



12068
(11504981)
Phosphate

M6.3-1.81 x 30mm
(#14 x 1-3/16")
Hex Head Sems®
24mm (15/16") Washer O.D.
10mm Hex
GM

UNIT PACKAGE: 50



19417
(Chrys: 6503819, 6503401;
GM: 25631448)
Black Nylon

M7.5 x 35mm
Square Drive Truss Head
22mm Head Diameter
9mm Shoulder Diameter
Foam To Bumper Fascia
Chrysler
1993-On
GM 1997 - On

UNIT PACKAGE: 15



12350
(11500086)
Phosphate

M8-2.12 x 20mm
(5/16"-12 x 25/32")
Hex Washer Head
16mm (5/8") Washer Hd. O.D.
13mm Hex
GM

UNIT PACKAGE: 25



21517
(25705182)
Black Nylon

M9.5 x 46mm
Square Drive Truss Head
22mm Head Diameter
GM

UNIT PACKAGE: 25

Sec. 7

METRIC ITEMS



20970

(Not Available From O.E.M.)
Black Nylon

M14 x 34mm
Bumper and Door Insulator
Nylon Screw
22mm Head O.D.
No. 3 Square Drive
Fits Into 12mm Hole
GM, Ford & Chrysler
2005 - On

UNIT PACKAGE: 25



16986

(14003784)
Zinc

M8-1.25 x 25mm
Stainless Steel Capped
Pan Head w/o Nuts
Head Diameter: 19mm
Shoulder Length: 3mm
GM

UNIT PACKAGE: 25



15310

(11503687)
Phosphate

M8-1.25 x 30mm
Uncapped Round Head
w/o Nuts
Head Diameter: 17.5mm
Shoulder Length: 3mm
GM

UNIT PACKAGE: 25



11404

(N14-4003)
Plain

M8-1.25 x 35mm
Class 4.8
Volkswagen Intake
Manifold

UNIT PACKAGE: 25



17559

Zinc & Yellow Dichromate

M10-1.25 x 42mm
Class 8.8

Exhaust Systems
Honda, Nissan & Toyota

UNIT PACKAGE: 10

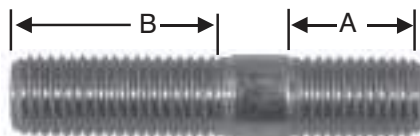

17560

Zinc & Yellow Dichromate

M10-1.25 x 48mm
Dim. A: 15mm Dim. B: 25mm
Class 8.8

Exhaust Systems
Honda, Nissan & Toyota

UNIT PACKAGE: 10



17596

Zinc & Yellow Dichromate

M12-1.25 x 50mm
Class 8.8

Catalytic Converter
Mazda

UNIT PACKAGE: 5

Cylinder Head And Manifold Metric Studs

Grade 8 Medium Carbon Heat Treated Alloy Steel

Regular Pitch

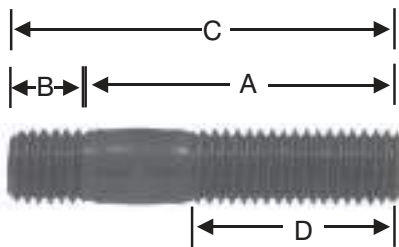

Auveco Part No.	A Diameter & Length	B Diameter & Length	C Overall Length	D Length	Unit Pkg.
11973	6mm-1.00 x 20mm	6mm-1.00 x 7.5mm	27.5mm	18mm	10
11974	6mm-1.00 x 25mm	6mm-1.00 x 7.5mm	32.5mm	18mm	10
11980	8mm-1.25 x 20mm	8mm-1.25 x 10mm	30.0mm	16mm	10
11981	8mm-1.25 x 25mm	8mm-1.25 x 10mm	35.0mm	22mm	10
11982	8mm-1.25 x 30mm	8mm-1.25 x 10mm	40.0mm	22mm	10
11983	8mm-1.25 x 35mm	8mm-1.25 x 10mm	45.0mm	22mm	10
11984	8mm-1.25 x 40mm	8mm-1.25 x 10mm	50.0mm	22mm	10
11987	8mm-1.25 x 55mm	8mm-1.25 x 10mm	65.0mm	22mm	10
11989	10mm-1.50 x 30mm	10mm-1.50 x 12mm	42.0mm	18mm	10
11990	10mm-1.50 x 35mm	10mm-1.50 x 12mm	47.0mm	26mm	10
11991	10mm-1.50 x 40mm	10mm-1.50 x 12mm	52.0mm	26mm	10
11993	10mm-1.50 x 50mm	10mm-1.50 x 12mm	62.0mm	26mm	10
11995	10mm-1.50 x 65mm	10mm-1.50 x 12mm	77.0mm	26mm	5
11998	12mm-1.75 x 30mm	12mm-1.75 x 15mm	45.0mm	25mm	5



DIN 934 Regular Pitch Metric Hex Nuts

Steel • Zinc Plated • Class 8
Tensile Strength: 116,000 Max.

Auveco Part No.	Size	Pitch (mm)	Hex Width	Unit Pkg.
10569	4mm	.70	7mm	25
14448	4mm	.70	7mm	50
10570	5mm	.80	8mm	25
14449	5mm	.80	8mm	50
10571	6mm	1.00	10mm	25
14450	6mm	1.00	10mm	100
10572	7mm	1.00	11mm	25
14451	7mm	1.00	11mm	50
10573	8mm	1.25	13mm	25
14452	8mm	1.25	13mm	100
10575	10mm	1.50	17mm	10
14454	10mm	1.50	17mm	50
10576	12mm	1.75	19mm	10
14455	12mm	1.75	19mm	25
14625	14mm	2.00	22mm	25
14626	16mm	2.00	24mm	25



DIN 934 Fine Pitch Metric Hex Nuts

Steel • Zinc Plated • Class 8
Tensile Strength: 116,000 Max.

Auveco Part No.	Size	Pitch (mm)	Hex Width	Unit Pkg.
10574	8mm	1.00	13mm	25
14453	8mm	1.00	13mm	50
11277	10mm	1.00	17mm	10
14456	10mm	1.00	17mm	25
11278	10mm	1.25	17mm	10
14457	10mm	1.25	17mm	25
11279	12mm	1.25	19mm	10
14458	12mm	1.25	19mm	25
11280	12mm	1.50	19mm	10
14459	12mm	1.50	19mm	25
21426	14mm	1.50	22mm	10
14629	16mm	1.50	24mm	25



J.I.S. Small Hex Nuts

J.I.S. B1181 • Steel • Heat Treated
I.S.O. Class 8 Zinc Plated

Auveco Part No.	Size	Pitch mm	Hex Width	Unit Pkg.
14796	8mm	1.25	12mm	25
17391	8mm	1.25	12mm	100
14797	10mm	1.25	14mm	15
17392	10mm	1.25	14mm	50
16617	12mm	1.25	17mm	25



DIN 985 Metric Nylon Insert Lock Nuts

Heat Treated Alloy Steel • Zinc Plated

Auveco Part No.	Unit Pkg.	Size	Pitch (mm)	Hex Width
11049	100	4mm	.70	7mm
11051	100	5mm	.80	8mm
11053	100	6mm	1.00	10mm
11055	100	8mm	1.25	13mm
11057	100	10mm	1.50	17mm
11059	100	12mm	1.75	19mm



Type A



Type B

Metric Free Spinning Washer Nuts

Auveco Part No.	Thread Size	Type	Washer O.D.	Hex Size	Height	Plating	O.E.M. No.	Unit Pkg.	
15325	M4-0.7	B	12mm	9mm	4.5mm	Phosphate	N621900, N800466	50	
16883	M5-0.8	B	10mm	8mm	7mm	Zinc & Yellow	N802775-S36	50	
15326	M5-0.8	B	15mm	10mm	7mm	Phosphate	N621903	50	
15327	M5-0.8	B	19mm	10mm	7mm	Phosphate	11504614	50	
19216	M6-1.0	B	14mm	10mm	8mm	Phosphate	6100047	50	
12595	M6-1.0	A	16mm	10mm	7mm	Phosphate	11505329, 11503752, N90100001	25	
16268	Same as 12595 except for packaging								50
15328	M6-1.0	B	16mm	11mm	8.5mm	Phosphate	N621905	50	
16136	M6-1.0	B	18mm	10mm	7mm	Zinc & Yellow	94515340	25	
15329	M6-1.0	B	18mm	10mm	9mm	Phosphate	6100048	50	
12596	M6-1.0	A	19mm	11mm	9.5mm	Phosphate	11503754, 11503756	25	
15330	M6-1.0	B	19mm	10mm	8mm	Zinc	11508275	50	
16774	M6-1.0	B	19mm	11mm	9mm	Zinc & Yellow	N621906-S36	50	
15331	M6-1.0	B	20mm	10mm	9mm	Phosphate	6100049	50	
15332	M6-1.0	B	24mm	11mm	9mm	Zinc & Yellow	N621907	25	
15333	M8-1.25	B	18mm	13mm	10mm	Phosphate	6100050	25	
15334	M8-1.25	B	19mm	13mm	10mm	Phosphate	11501800	25	
15335	M8-1.25	B	24mm	13mm	10.5mm	Phosphate	11503695, 11506117, N621940	25	
15337	M10-1.5	B	24mm	15mm	13mm	Phosphate	N621942	25	
21001	M12-1.75	B	28mm	18mm	16mm	Phosphate	N621945-S2	10	



Metric Flange Lock Nuts



Auveco Part No.	Thread Size	Flange O.D.	Hex Size	Height	Plating	O.E.M. No.	Unit Pkg.
18251	M6-1.0	14mm	10mm	6mm	Zinc & Yellow		50
15316	M6-1.0	14mm	10mm	7.5mm	Phosphate	N620480	50
11709	M8-1.25	17mm	13mm	8.5mm	Zinc	11502811	50
15317	M8-1.25	17mm	13mm	9mm	Phosphate	N801310	50
15318	M10-1.5	20.5mm	15mm	13mm	Phosphate	N620482	25
11708	M10-1.5	21mm	15mm	11.5mm	Zinc	11502812	25
14521	M10-1.5	21mm	15mm	12mm	Phosphate		25
14522	M12-1.75	25mm	18mm	14mm	Phosphate		25
14523	M16-2.0	33mm	24mm	18mm	Phosphate		10



METRIC ITEMS

Metric Hex Flange Nuts



Auveco Part No.	Thread Size	Flange O.D.	Hex Size	Height	Plating	O.E.M. No.	Unit Pkg.
16880	M4-7	11mm	7mm	5mm	Black Zinc	14031900	50
17495*	M4-7	14mm	8mm	6mm	Zinc	N620391-S36	50
19309	M5-8	11.5mm	8mm	5mm	Black Oxide		50
19308	M5-8	11.5mm	8mm	5mm	Zinc	11502702	50
19205	M6-1.0	14mm	10mm	6mm	Phosphate	11503745	100
20450	M6.3-1.81	20mm	11mm	7mm	Zinc Organic	22516030	25
11644	M8-1.25	17mm	13mm	8mm	Phosphate	11501889	25
16269	Same As 11644 Except For Packaging						50
						11502609, 11507036	
18253	M10-1.25	19mm	14mm	9mm	Zinc & Yellow		50
11645	M10-1.5	21mm	15mm	10mm	Phosphate	11501850	25
20606	M12-1.75	25mm	18mm	12mm	Phosphate		25

* With Sealer



Metric Spin Lock Nuts With Serrations

Case Hardened



Auveco Part No.	Thread Size	Flange O.D.	Hex Size	Plating	Unit Pkg.
Standard Flange					
16769	M6-1.0	14mm	10mm	Zinc	50
16830	M8-1.25	17mm	12mm	Zinc	50
16470	M10-1.25	19mm	14mm	Zinc	25
Large Flange					
14855	M6-1.0	17mm	10mm	Phos	100
14856	M8-1.25	19mm	13mm	Phos	100

Nylon Coated Acorn Nuts



Auveco Part No.	Size	Hex	Height	Unit Pkg.
20570	M4-0.7	10mm	11mm	15



Metric Hex Lock Nuts

Auveco Part No.	Thread Size	Hex Size	Finish	Unit Pkg.
12110	M4-7	9mm	Phosphate	50



Metric Wing Nuts

DIN D00213 -Zinc Plated

Auveco Part No.	Thread Size	Unit Pkg.
17010	M6-1.0	25



18531

(6503837)
Black

Ziptwist Wing Nut
Fits 6mm Stud
5/8" O.D.

UNIT PACKAGE: 50



15811

(10129981)
Zinc

M14-2.0; Lock Nut
24mm Hex; GM

UNIT PACKAGE: 10



14185

(11508987)
Black Phosphate

3.2mm (1/8") Stud Size; Thread Cutting Nut
7mm Hex; 2mm High; GM

UNIT PACKAGE: 100



Metric Washer Lock Nuts



Auveco Part No.	Thread Size	Flange Diameter	Finish	Height	Hex Size	O.E.M. Number	Unit Pkg.
15714*	M4-7	12mm	Phos	6mm	9mm	11501854	50
12254	M5-8	14mm	Zinc	6mm	10mm	11501814	100

*With Sealer



Washer Type Metric Self-Threading Nuts



Auveco Part No.	Stud Size	Hex Width	Washer Dia.	Finish	O.E.M. Number	Unit Pkg.
16134 w/Sealer	3mm	8mm	13.5mm	Zinc & Yellow		25
12251	3.2mm	8mm	11mm	Zinc & Yellow	11502556	25
12115	4mm	9mm	15mm	Zinc	11502549	100
12116	5mm	10mm	15mm	Phosphate	11508900	50
12253	5mm	10mm	15mm	Phosphate	11501835, 10062	50
19548	6mm	11mm	15mm	Zinc	6100814	50
16829	6mm	11mm	18mm	Zinc	6100815	100
12117	6.3mm	11mm	18mm	Zinc	11503432	50
12255	6.3mm	11mm	18mm	Zinc	11501836	50
15711	8mm	13mm	20mm	Zinc	11502507, 11509535, 11514282	100

*With Sealer



Metric Push-On Retainers

For Non-Threaded Fasteners



Auveco Part No.	Stud Size	Diameter	Finish	Unit Pkg.
12118	3.2mm	9.5mm	Zinc	100
12119	4mm	11mm	Zinc	100



Metric Pushnut Bolt Retainers





For Threaded Fasteners



Auveco Part No.	Thread Size	O.D.	Finish	Unit Pkg.
12122	M5-0.8	11mm	Zinc	100
12123	M6-1.0	13mm	Zinc	100
14980	M6-1.0	17mm	Zinc	100
12124	M6.3-1.0	13mm	Zinc	100
12125	M8-1.25	16mm	Zinc	100
12259	M8-1.25	24mm	Zinc	50
12126	M10-1.50	20mm	Phosphate	50
12260	M10-1.50	24mm	Dacromet	100
12127	M12-1.75	21mm	Zinc	50
16980	M14-2.0	25mm	Phosphate	50

METRIC ITEMS

Tubular Type Nuts (Listed By Stud Size)

<p>Twice Actual Size</p>  <p>13150 (123-997-03-81) Amber Nylon</p> <p>For 2mm Stud Fits Into 4mm Hole Overall length: 7mm</p> <p>UNIT PACKAGE: 50</p>	 <p>13227 (113-853-615A) Natural Nylon</p> <p>For 3mm Stud Fits Into 4mm Hole Overall Length: 10mm</p> <p>UNIT PACKAGE: 50</p>	 <p>20472 (91512-SR3-004) White Nylon</p> <p>Tubular Nut With Sealer & Sealed End</p> <p>For 3mm Stud Head Dia: 8.5mm Fits Into 6mm Hole</p> <p>UNIT PACKAGE: 10</p>	 <p>16124 (001-988-20-81) Red Nylon</p> <p>For 5mm Stud Fits Into 9mm Hole Overall Length: 14mm</p> <p>UNIT PACKAGE: 50</p>	 <p>13170 (5131-1-802-258) Natural Nylon</p> <p>For 7mm Stud Fits Into 8mm Hole Overall Length: 20mm</p> <p>UNIT PACKAGE: 50</p>
---	--	--	---	--

Cage Nuts

 <p>16142 Zinc</p> <p>M6-1.0 Screw Size Panel Range: 1.7mm-2.7mm</p> <p>UNIT PACKAGE: 25</p>	 <p>20651 (001-990-00-91) Zinc & Yellow</p> <p>M6-1.0 Screw Size Panel Range: .5mm - 1.7mm Center of Hole To Edge: 15mm</p> <p>UNIT PACKAGE: 10</p>
--	--

“U” & “J” Nuts By Screw Size

 <p>20648 (123-994-01-45) Zinc & Yellow</p> <p>2.9mm (#4) Screw Size Panel Range: .7mm - 1.5mm Ctr. of Hole to Edge: 4mm</p> <p>UNIT PACKAGE: 50</p>	 <p>13224 (000-994-04-45) Zinc & Yellow</p> <p>4.2mm (#8) Screw Size Panel Range: .5mm-1.7mm Ctr of Hole to Edge: 8mm</p> <p>UNIT PACKAGE: 50</p>
 <p>13221 (0712-9-925-706) Zinc & Yellow</p> <p>2.9mm Screw Size Panel Range: .5mm-1.5mm Ctr of Hole to Edge: 6mm</p> <p>UNIT PACKAGE: 50</p>	 <p>13217 (N15.422.2) Zinc & Yellow</p> <p>4.2mm (#8) Screw Size Panel Range: .7mm-1.6mm Ctr of Hole to Edge: 7mm</p> <p>UNIT PACKAGE: 25</p>
 <p>20649 Zinc & Yellow</p> <p>3.5mm (#6) Screw Size Panel Range: .5mm - 1.5mm Ctr. of Hole to Edge: 8mm</p> <p>UNIT PACKAGE: 50</p>	 <p>13223 (BMW: 0712-9-925-708; Mercedes: 000-994-25-45) Zinc & Yellow</p> <p>4.2mm (#8) Screw Size Panel Range: 3mm-4mm Ctr of Hole to Edge: 7mm</p> <p>UNIT PACKAGE: 50</p>

Sec. 7

METRIC ITEMS



13225
Zinc

4.2mm (#8) Screw Size
Panel Range: .5mm-2.5mm
Ctr of Hole to Edge: 8mm

UNIT PACKAGE: 50



13216
Zinc
& Yellow

4.8mm (#10) Screw Size
Panel Range: .9mm-2mm
Center of Hole to Edge: 8mm

UNIT PACKAGE: 25



20650
Zinc & Yellow
(123-994-08-45)

4.2mm (#8) Screw Size
Panel Range: .5mm-2.5mm
Ctr. of Hole to Edge: 14mm

UNIT PACKAGE: 25



21017
(Nissan: 76882-0M000)
White Nylon

4.8mm(#10) Screw Size
Panel Range: Up To 1.5mm
Center of Hole To Edge: 8mm

UNIT PACKAGE: 15



13215
Zinc
& Yellow

4.8mm(#10) Screw Size
Panel Range: .8mm-1.7mm
Ctr of Hole to Edge: 11mm

UNIT PACKAGE: 50



13218
Zinc & Yellow

4.8mm(#10) Screw Size
Panel Range: .5mm-1.7mm
Ctr of Hole to Edge: 7mm

UNIT PACKAGE: 50



14750
Black Nylon

4.8mm (#10) Screw Size
Panel Range: Up to 1mm
Ctr of Hole to Edge: 11mm

UNIT PACKAGE: 15

19669

Same As 14750 Except For Packing

UNIT PACKAGE: 25



17993
Black Nylon

4.8mm (#10) Screw Size
Panel Range: Up to 3mm
Ctr of Hole to Edge: 14mm

UNIT PACKAGE: 10



19735
(Nissan:
63848-35F00)
Black Nylon

4.8mm (#10) Screw Size
Panel Range: Up to 2mm
Center Of Hole To Edge: 8mm

UNIT PACKAGE: 15



21359
(Toyota: 53879-17020)
Black Nylon

M4.8 (#10) Screw Size
Panel Range: Up To 2mm
Center Of Hole To Edge: 10mm

UNIT PACKAGE: 10



21616
(Toyota:
76647-42010)
Black Nylon

M4.8 (#10) Screw Size
Panel Range: Up to 2mm
Center of Hole to Edge: 7mm

UNIT PACKAGE: 15



21539
(GM: 9114472)
Blue Nylon

M5.5 (#12) Screw Size
Panel Range: Up To 3.5mm (9/64")
Center Of Hole To
Edge: 8mm (5/16")

Use With Auveco 21541

UNIT PACKAGE: 25



21540
(GM: 24449408)
Orange Nylon

M5.5 (#12) Screw Size
Panel Range: Up To 2mm (5/64")
Center Of Hole To
Edge: 12mm (15/32")

Use With Auveco 21541

UNIT PACKAGE: 25



21613
(Toyota:
53879-20020)
Black Nylon

M5.5 (#12) Screw Size
Panel Range: Up To 2mm
Center Of Hole To Edge: 11mm

UNIT PACKAGE: 15



13162
Zinc & Yellow

5.6mm Screw Size
Pnl Range: 1.2mm-2.0mm
Ctr of Hole to Edge: 10mm

UNIT PACKAGE: 50



17193
(Nissan: 01241-00551,
63848-D0100)
Nylon

5.6mm (#12) Screw Size
Panel Range: Up to 1mm
Ctr of Hole to Edge: 9mm

UNIT PACKAGE: 15



17385
(Nissan: 63848-D4000)
Black Nylon

5.6mm (#12) Screw Size
Panel Range: Up to 2mm
Ctr of Hole to Edge: 9mm

UNIT PACKAGE: 10



20956
(Toyota: 90467-05114)
Black Nylon

5.5mm (#12) Screw Size
Panel Range: Up To 1mm
Ctr of Hole to Edge: 14mm

UNIT PACKAGE: 10



21614
(Toyota: 90467-05128)
White Nylon

M6 (#14) Screw Size
Panel Range: Up To 2mm
Center Of Hole To Edge: 12mm

UNIT PACKAGE: 15



21615
(Toyota: 90467-A0018,
90467-05081)
Maroon Nylon

M6 (#14) Screw Size
Panel Range: Up To 2mm
Center Of Hole To Edge: 12mm

UNIT PACKAGE: 15



21459
(Nissan: 01241-00881)
Black Nylon
With Captive Metal
Hex Nut

M6 - 1.0 Thread
Panel Range: Up To 4mm
Center Of Hole To Edge: 14mm

UNIT PACKAGE: 10



21378
(Hyundai: 86825-28000)
Black Nylon

M6 (#14) Screw Size
Panel Range: Up To 1.5mm
Center Of Hole To Edge: 8mm

UNIT PACKAGE: 25



13220
(Mercedes: 000-994-09-14;
Volvo: 946-418;
Opel: 20-72-175)
Zinc & Yellow

6.3mm (#14) Screw Size
Panel Range: .7mm-1.5mm
Center of Hole to Edge: 13mm

UNIT PACKAGE: 50



14276
(Toyota: 53879-22010)
Black Nylon

6.3mm (#14) Screw Size
Panel Range: Up to 1mm
Center of Hole to Edge: 15mm

UNIT PACKAGE: 15

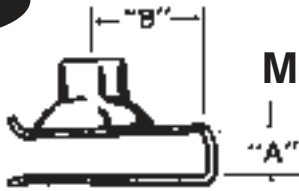

METRIC ITEMS

Metric Extruded "U" Nuts
(Foldover Nuts)



Auveco Part No.	Thread Size	"A" Panel Range		"B" Foldover Clear		Finish	O.E.M. No.	Unit Pkg.
		mm	Inches	mm	Inches			
18337	M4-.7	0.60-3.80	1/32-5/32	9.5	3/8	Zinc Organic	11500654, N623330-S2	50
11625	M4-.7	0.80-4.00	1/32-5/32	13.5	17/32	Phosphate	11500655	50
20339	M4.2-1.41*	0.50-2.00	1/32"-5/64	10	25/64"	Zinc Organic	11516397	50
21040	M4.2-1.41*	0.65-3.80	1/32-5/32	9.5	3/8	Zinc Organic	11513599	25
18338	M5-.8	0.60-3.80	1/32-5/32	11	7/16	Phosphate	11505596, N623331-S2	50
11626	M5-.8	0.80-4.00	1/32-5/32	15.8	5/8	Phosphate	11500657	50
16846	M6-1.0*	0.80-4.00	1/32-5/32	12	15/32	Phosphate	6502152	50
16842	M6-1.0	3.40-6.30	9/64-1/4	13.5	17/32	Phosphate	11504047 N802331-S53	25
18449	M6-1.0*	0.80-4.00	1/32-5/32	13.5	17/32	Phosphate	6101308	50
11864	M6-1.0	0.80-4.00	1/32-5/32	13.5	17/32	Phosphate	11503714, 11503716	50
12669	M6-1.0	0.80-4.00	1/32-5/32	13.5	17/32	Phosphate	1016937, 11503957, N623332-S2, -S53 & S-100	25
18880	M6-1.0	3.00-4.00	1/8-5/32	13.5	17/32	Zinc Organic	21095741	50
18881	M6-1.0	3.50-4.00	9/64-5/32	13.5	17/32	Zinc Colbalt Black	21095560	10
12666	M6-1.0	3.40-6.30	9/64-1/4	14.5	9/16	Zinc Organic	11504978	25
20416	M6-1.0	2.00-5.00	5/64-3/16	14.5	9/16	Zinc Organic	11516372	25
19144	M6-1.0	3.40-6.30	9/64-1/4	19	3/4	Black Phosphate	11505048	15
12575	M6-1.0	0.34-4.00	1/64-5/32	19.5	25/32	Phosphate	11503715	25
16322	M6-1.0	1.00-2.50	3/64-3/32	19.5	25/32	Phosphate	14040999	50
19480	M6-1.0	4.30-5.60	11/64-7/32	21.0	13/16	Phosphate	N805889-S100	15
11627	M6.3-1.0	0.80-4.00	1/32-5/32	13.5	17/32	Phosphate	11502785	25
11628	M6.3-1.0	0.80-4.00	1/32-5/32	13.5	17/32	Phosphate	11500658	25
12667	M8-1.25	1.50-5.50	1/16-7/32	14.5	9/16	Zinc Organic	11503455, 11504288	25
11629	M8-1.25	0.80-4.00	1/32-5/32	14.5	9/16	Phosphate	11500660, 11502617, N623333-S2	25
11630	M8-1.25	0.80-4.50	1/32-11/64	20	13/16	Phosphate	11500661, 11503317, N623343-S2	25
19644	M8-1.25	1.70-5.50	1/16-7/32	28.5	1-1/8	Phosphate	10084751	15
19824	M8-1.25	3.90-4.40	5/32-11/64	10	25/64	Phosphate	371964	25
18401	M8-1.25*	4.00-7.00	5/32-9/32	21	13/16	Black Phosphate	N801117-S10	25
20447	M10-1.50	1.50-5.50	1/16-7/32	18	23/32	Zinc Organic	N623334-S426	10
11631	M10-1.50	1.00-6.00	3/64-15/64	19	3/4	Phosphate	11500662	25
18339	M10-1.50	1.50-5.50	1/16-7/32	28	1-3/32	Zinc Organic	11500663, N623344-S2	25

*Locking Feature



METRIC ITEMS

Metric Flat Washers - DIN 125



Auveco Part No.	Screw Size	I.D.	O.D.	Thickness	Finish	Unit Pkg.
10577	4mm	4.3mm	9mm	0.8mm	Zinc	50
10578	5mm	5.3mm	11mm	1mm	Zinc	50
10579	6mm	6.4mm	12mm	1.5mm	Zinc	50
17393	6mm	6.4mm	12mm	1.5mm	Zinc	100
16763	6mm	6.4mm	12mm	1.5mm	Zinc & Yellow	100
10580	7mm	7.4mm	14mm	1.5mm	Zinc	50
10581	8mm	8.4mm	17mm	2mm	Zinc	25
17394	8mm	8.4mm	17mm	2mm	Zinc	100
16764	8mm	8.4mm	17mm	1.5mm	Zinc & Yellow	100
10582	10mm	10.5mm	21mm	2mm	Zinc	25
17395	10mm	10.5mm	21mm	2mm	Zinc	100
10583	12mm	13mm	24mm	2.5mm	Zinc	25
14632	14mm	15mm	28mm	2.5mm	Zinc	50
14633	16mm	17mm	30mm	3mm	Zinc	50
14634	20mm	21mm	37mm	3mm	Zinc	50



Metric Lock Washers - DIN 127

Spring Steel - Zinc Plated

Auveco Part No.	Screw Size	I.D.	O.D.	Thick-ness	Unit Pkg.
10584	4mm	4.1mm	7.4mm	0.9mm	50
10585	5mm	5.1mm	9.0mm	1.2mm	50
10586	6mm	6.1mm	11.5mm	1.6mm	50
17396	6mm	6.1mm	11.5mm	1.6mm	100
10587	7mm	7.1mm	12.2mm	1.6mm	50
10588	8mm	8.2mm	14.4mm	2mm	50
17397	8mm	8.2mm	14.4mm	2mm	100
10589	10mm	10.2mm	17.5mm	2.2mm	50
17398	10mm	10.2mm	17.5mm	2.2mm	100
10590	12mm	12.2mm	20.3mm	2.5mm	25
14636	16mm	16.2mm	27.4mm	3.5mm	50
14637	20mm	20.2mm	33.6mm	4mm	50

Do You Want Your Customers To Know You Use The Best Body Hardware & Specialty Fasteners Available?

Promotional Products And Apparel Bearing The  Logo Promote Your Identity As A Professional.



Metric Spring Washers - DIN 137

Spring Steel - Zinc Plated

Auveco Part No.	Screw Size	I.D.	O.D.	Thick-ness	Unit Pkg.
10591	4mm	4.3mm	8mm	0.5mm	50
10592	5mm	5.3mm	10mm	0.5mm	50
10593	6mm	6.4mm	11mm	0.5mm	50
10595	8mm	8.4mm	15mm	0.5mm	50
10596	10mm	10.5mm	18mm	0.8mm	25



Metric Copper Washers

DIN 7603

Auveco Part No.	Screw Size	I.D.	O.D.	Thick-ness	Unit Pkg.
14866	8mm	8.2mm	11.8mm	0.8mm	50
14867	10mm	10.2mm	15.8mm	0.8mm	50
14868	12mm	12.2mm	17.8mm	1.4mm	25
14869	14mm	14.2mm	17.8mm	1.4mm	25
14870	14mm	14.2mm	19.8mm	1.4mm	25
14871	16mm	16.2mm	19.8mm	1.4mm	25

METRIC ITEMS

For Actual Size Illustrations Refer to Pages 117-119



**Retaining Rings - Basic Internal
DIN 472 - 1300**

Groove Required In Bore
Phosphate & Oil Finish



Auveco Part No.	Shaft Diameter		Groove Diameter		Groove Width		Unit Pkg.
	mm	Inches	mm	Inches	mm	Inches	
11486	26	1.024	27.2	1.072	1.30	.051	50
11488	30	1.181	31.4	1.237	1.30	.051	50
11489	32	1.260	33.7	1.328	1.30	.051	50
11490	35	1.378	37.0	1.457	1.60	.063	50
11491	40	1.575	42.5	1.675	1.85	.073	25
11492	42	1.654	44.5	1.753	1.85	.073	25
11494	52	2.047	55.0	2.165	2.15	.085	25
11495	62	2.441	65.0	2.559	2.15	.085	10
11496	72	2.835	75.0	2.953	2.65	.104	10



**Retaining Rings - Basic External
DIN 471 - 1400**

Groove Required On Shaft
Phosphate & Oil Finish



Auveco Part No.	Shaft Diameter		Groove Diameter		Groove Width		Unit Pkg.
	mm	Inches	mm	Inches	mm	Inches	
11500	10.0	.394	9.6	.378	1.10	.043	100
11501	12.0	.472	11.5	.452	1.10	.043	100
11502	15.0	.591	14.3	.563	1.10	.043	100
11503	17.0	.670	16.2	.637	1.10	.043	50
11504	20.0	.787	19.0	.748	1.30	.051	50
11505	25.0	.985	23.9	.941	1.30	.051	50
11506	30.0	1.182	28.6	1.126	1.60	.063	50
11507	35.0	1.378	33.0	1.299	1.60	.063	50



**Retaining Rings - "E" Type
DIN 6799 - 1500**

Phosphate & Oil Finish



Auveco Part No.	Shaft Diameter		Groove Diameter		Groove Width		Unit Pkg.
	mm	Inches	mm	Inches	mm	Inches	
11513	1.4	.055	1.2	.047	0.34	.0134	100
11514	2.0	.079	1.5	.059	0.44	.0173	100
11515	2.5	.098	1.9	.075	0.54	.0213	100
11516	3.0	.118	2.3	.091	0.64	.0252	100
11517	4.0	.157	3.2	.126	0.64	.0252	100
11518	5.0	.197	4.0	.157	0.74	.0291	100
11519	6.0	.236	5.0	.197	0.74	.0291	100
11520	7.0	.276	6.0	.236	0.74	.0291	100
11521	8.0	.315	7.0	.276	0.94	.0370	100
11523	10.0	.394	9.0	.354	1.15	.0453	100
11527	20.0	.787	19.0	.748	1.78	.0700	50

METRIC ITEMS
Metric Grease Fittings

(Also Available In Large Bulk Quantities)



6mm-1.00, Straight
DIN 71412 (VW: N185151)
Overall Length: 14mm
Ball Check
Plated

Ref No.
8601

11097 Unit Package: 5
15122 Unit Package: 50
15123 Unit Package: 100
15426 Unit Package: 1000



6mm-1.00, 45°
Overall Length: 22mm
Ball Check
Plated

Ref No
7045

11775 Unit Package: 10
15132 Unit Package: 50
15133 Unit Package: 100
15431 Unit Package: 1000



6mm-1.00, 90°
Overall Length: 18mm
Ball Check
Plated

Ref No.
7090

11776 Unit Package: 10
15134 Unit Package: 50
15135 Unit Package: 100



8mm-1.00, Straight
DIN 71412 (VW: N185161)
Overall Length: 15mm
Ball Check
Plated

Ref No.
8901

11098 Unit Package: 5
15124 Unit Package: 50
15125 Unit Package: 100



8mm-1.00, 45°
Overall Length: 23mm
Ball Check
Plated

Ref No.
7445

11777 Unit Package: 10
15136 Unit Package: 50
15137 Unit Package: 100



8mm-1.00, 90°
DIN 71412
(VW: N18 511 2)
Overall Length: 18mm
Ball Check
Plated

Ref No.
7940

11099 Unit Package: 5
15126 Unit Package: 50
15127 Unit Package: 100



8mm-1.25, Straight
Overall Length: 15mm
Ball Check
Plated

Ref No.
9201

11778 Unit Package: 10
15138 Unit Package: 50
15139 Unit Package: 100
15434 Unit Package: 1000



8mm-1.25, 45°
Overall Length: 23mm
Ball Check
Plated

Ref No.
7545

11779 Unit Package: 10
15140 Unit Package: 50
15141 Unit Package: 100



8mm-1.25, 90°
Overall Length: 18mm
Ball Check
Plated

Ref No.
7590

11780 Unit Package: 10
15142 Unit Package: 50
15143 Unit Package: 100
15436 Unit Package: 1000



10mm-1.00, Straight
DIN71412 (VW: N185301)
Overall Length: 15mm
Ball Check
Plated

Ref No.
9301

11100 Unit Package: 5
15128 Unit Package: 50
15129 Unit Package: 100



10mm-1.00, 45°
Overall Length: 23mm
Ball Check
Plated

Ref No.
9345

15067 Unit Package: 25
15098 Unit Package: 100
15099 Unit Package: 250



10mm-1.00, 90°
DIN 71412
(VW: N18 510 1)
Overall Length: 19mm
Ball Check
Plated

Ref No.
9390

11101 Unit Package: 5
15130 Unit Package: 50
15131 Unit Package: 100



10mm-1.5 Straight
Overall Length: 15mm
Ball Check

Ref No.
9501

17555 Unit Package: 50



17155

Ref. No. 8036

6mm-1.0, Straight
Overall Length: 14mm
UNIT PACKAGE: 5



17156

Ref. No. 8058

8mm-1.00, Straight
Overall Length: 15mm
UNIT PACKAGE: 5

Stainless Steel Grease Fittings With Ball Check
303 Series Body • 420 Series Ball • 302 Series Spring

METRIC ITEMS



Concave Type



Cup Type

Metric Expansion Plugs

Zinc Plated

Auveco Part No.	Size	Type	Unit Pkg.
11876	18.0mm	Cup	25
11877	20.0mm	Cup	25
11878	22.0mm	Cup	25
11879	25.0mm	Cup	25
11881	30.0mm	Cup	25
11884	35.0mm	Cup	10
11886	38.0mm	Cup	10
11888	40.3mm	Cup	10
11895	49.5mm	Cup	10
11896	50.0mm	Cup	10
11899	35.0mm	Concave	25



Metric Cotter Pins

DIN 94 • Steel

Auveco Part No.	Diameter	Length	Unit Pkg.
10553	2mm	18mm	100
10554	2mm	20mm	100
10556	2.5mm	25mm	100
10557	3.2mm	20mm	100
10558	3mm	25mm	100
10559	3mm	30mm	100
10560	3mm	35mm	50
10562	4mm	30mm	50
10563	4mm	35mm	50
10564	4mm	40mm	50
10566	5mm	35mm	25
10567	5mm	40mm	25
10568	5mm	45mm	25

For an assortment of Metric Cotter Pins, see Fix-Kit No. 6158 in the green pages.

METRIC OIL DRAIN PLUGS

Refer to the Oil Drain Plugs Listing in the Index.



METRIC OIL DRAIN PLUGS

Refer to the Oil Drain Plugs listing in the Index.



7955

Metric Screw Pitch Gauge:
Pitch Capacity 0.25 to 6mm
24 Blades

UNIT PACKAGE: 1

METRIC ITEMS

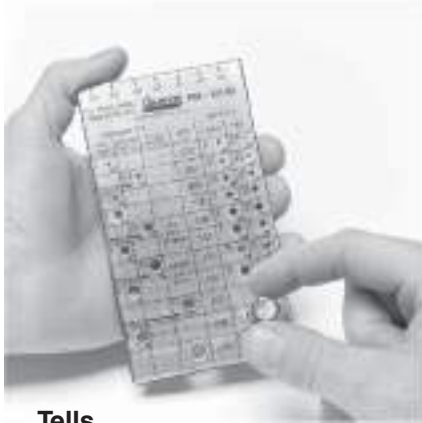

Metric Screw Checker

12143

For I.S.O. Metric Screws From
8mm (0.315")
Thru 14mm (0.551")

UNIT PACKAGE: 1

Tells

- Length in millimeters
- Tap series
- I.S.O. preference rating
- Diameter (in millimeters)
- Pitch (in millimeters)
- Clearance Drill size
- Tap Drill Size
- Basic Diameter (in inches)

Includes:

Instructions on how to use in identifying screws as well as how to use the Screw Checker for cutting and straightening screws and cleaning screw threads. There is also a Decimal Equivalent Chart for drill sizes.

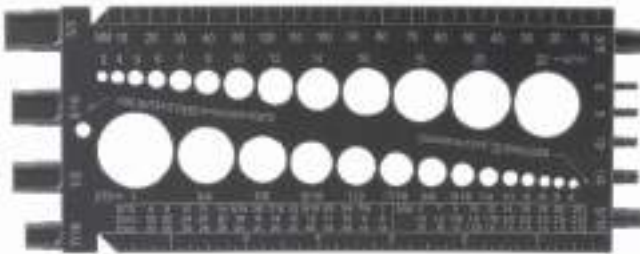

21152

U.S.S., S.A.E. & Metric Bolt and Nut Gauge
Excellent for sizing bolts, screws, nuts (USS, SAE, and Metric) and twist drills. You size the bolt diameter by pushing the bolt through the sizing holes. Also gauges hex nuts and washers (USS & SAE) while metric hex nuts and washers can be measured by holding them under the metric holes.

The back of the gauge includes a feature for measuring U.S. and Metric thread pitch. Special notches on the front of the tool allow you to measure flat head metal and wood screws.

Made of sturdy, light weight green plastic that resists water, alcohol, oil and grease.

UNIT PACKAGE: 1

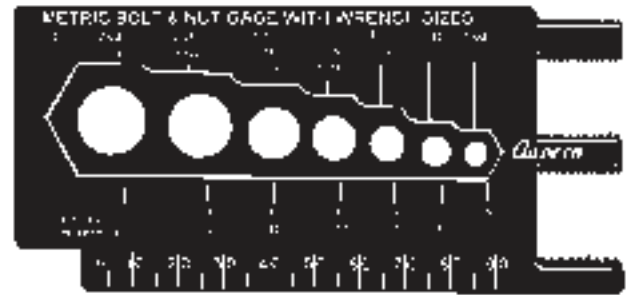

14770

Metric Bolt & Nut Gauge

Determine the diameter of the bolts by pushing them thru the holes. Measure the hex head of bolts & screws or the "across the flat" dimension of hex nuts in the recesses around the holes (listed as wrench size). Right-hand side of tool measures thread pitch (1.00, 1.50, 1.75 & 2.00)

UNIT PACKAGE: 1

Thread Pitches

Approximate Threads Per Inch For Metric Screws, Bolts and Nuts

Diameter in mm	3	4	5	6	7	8	10	12	14	16
Diameter in Inch	.118	.157	.197	.236	.276	.315	.394	.472	.551	.630
Standard Pitch mm	.5	.7	.8	1.0	1.0	1.25	1.5	1.75	2.0	2.0
Approx. Threads/Inch	51	36	32	25	25	20	17	14	12	12
Fine Pitch mm						1.0	1.25	1.5	1.5	1.5
Approx Threads. Inch						25	20	17	17	17
Extra Fine Pitch mm							1.0	1.25	1.25	1.25
Approx. Threads/Inch							25	20	20	20

METRIC ITEMS

Inch Fractions And Decimals To Metric Equivalents

Inches			Inches			Inches		
Fractions	Decimals	mm	Fractions	Decimals	mm	Fractions	Decimals	mm
_____	.0004	.01	15/32	.46875	11.906	_____	1.063	27
_____	.004	.10	_____	.4724	12	1-3/32	1.094	27.781
_____	.01	.25	31/64	.48437	12.303	_____	1.1024	28
1/64	.0156	.397	_____	.492	12.5	1-1/8	1.125	28.575
_____	.0197	.50	1/2	.500	12.700	_____	1.1417	29
_____	.0295	.75	_____	.5118	13	1-5/32	1.156	29.369
1/32	.03125	.794	33/64	.5156	13.097	_____	1.1811	30
_____	.0394	1	17/32	.53125	13.494	1-3/16	1.1875	30.163
3/64	.0469	1.191	35/64	.54687	13.891	1-7/32	1.219	30.956
_____	.059	1.5	_____	.5512	14	_____	1.2205	31
1/16	.0625	1.588	9/16	.5625	14.288	1-1/4	1.250	31.750
5/64	.0781	1.984	_____	.571	14.5	_____	1.2598	32
_____	.0787	2	37/64	.57812	14.684	1-9/32	1.281	32.544
3/32	.094	2.381	_____	.5906	15	_____	1.2992	33
_____	.0984	2.5	19/32	.59375	15.081	1-5/16	1.312	33.338
7/64	.1093	2.776	39/64	.60937	15.478	_____	1.3386	34
_____	.1181	3	5/8	.6250	15.875	1-11/32	1.344	34.131
1/8	.1250	3.175	_____	.6299	16	1-3/8	1.375	34.925
_____	.1378	3.5	41/64	.6406	16.272	_____	1.3779	35
9/64	.1406	3.572	_____	.6496	16.5	1-13/32	1.406	35.719
5/32	.15625	3.969	21/32	.65625	16.669	_____	1.4173	36
_____	.1575	4	_____	.6693	17	1-7/16	1.438	36.513
11/64	.17187	4.366	43/64	.67187	17.066	_____	1.4567	37
_____	.177	4.5	11/16	.6875	17.463	1-15/32	1.469	37.306
3/16	.1875	4.763	45/64	.7031	17.859	_____	1.4961	38
_____	.1969	5	_____	.7087	18	1-1/2	1.500	38.100
13/64	.2031	5.159	23/32	.71875	18.256	1-17/32	1.531	38.894
_____	.2165	5.5	_____	.7283	18.5	_____	1.5354	39
7/32	.21875	5.556	47/64	.73437	18.653	1-9/16	1.562	39.688
15/64	.23437	5.953	_____	.7480	19	_____	1.5748	40
_____	.2362	6	3/4	.7500	19.050	1-19/32	1.594	40.481
1/4	.2500	6.350	49/64	.7656	19.447	_____	1.6142	41
_____	.2559	6.5	25/32	.78125	19.844	1-5/8	1.625	41.275
17/64	.2656	6.747	_____	.7874	20	_____	1.6535	42
_____	.2756	7	51/64	.79687	20.241	1-21/32	1.6562	42.069
9/32	.28125	7.144	13/16	.8125	20.638	1-11/16	1.6875	42.863
_____	.2953	7.5	_____	.8268	21	_____	1.6929	43
19/64	.29687	7.541	53/64	.8281	21.034	1-21/32	1.719	43.656
5/16	.3125	7.938	27/32	.84375	21.431	_____	1.7323	44
_____	.3150	8	55/64	.85937	21.828	1-3/4	1.750	44.450
21/64	.3281	8.334	_____	.8662	22	_____	1.7717	45
_____	.335	8.5	7/8	.8750	22.225	1-25/32	1.781	45.244
11/32	.34375	8.731	57/64	.8906	22.622	_____	1.8110	46
_____	.3543	9	_____	.9055	23	1-13/16	1.8125	46.038
23/64	.35937	9.128	29/32	.90625	23.019	1-27/32	1.844	46.831
_____	.374	9.5	59/64	.92187	23.416	_____	1.8504	47
3/8	.3750	9.525	15/16	.9375	23.813	1-7/8	1.875	47.625
25/64	.3906	9.922	_____	.9449	24	_____	1.8898	48
_____	.3937	10	61/64	.9531	24.209	1-29/32	1.9062	48.419
13/32	.4062	10.319	31/32	.96875	24.606	_____	1.9291	49
_____	.413	10.5	_____	.9843	25	1-15/16	1.9375	49.213
27/64	.42187	10.716	1	1.000	25.4	_____	1.9685	50
_____	.4331	11	_____	1.0236	26	1-31/32	1.969	50.006
7/16	.4375	11.113	1-1/32	1.0312	26.194	2	2.000	50.800
29/64	.4531	11.509	1-1/16	1.062	26.988	_____	2.0079	51

METRIC ITEMS

Inch Fractions And Decimals To Metric Equivalents

Inches			Inches			Inches		
Fractions	Decimals	mm	Fractions	Decimals	mm	Fractions	Decimals	mm
_____	2.0472	52	_____	3.0709	78	4-1/4	4.250	107.950
2-1/16	2.062	52.388	_____	3.1102	79	4-5/16	4.312	109.538
_____	2.0866	53	3-1/8	3.125	79.375	_____	4.3307	110
2-1/8	2.125	53.975	_____	3.1496	80	4-3/8	4.375	111.125
_____	2.126	54	3-3/16	3.1875	80.963	4-7/16	4.438	112.713
_____	2.165	55	_____	3.1890	81	4-1/2	4.500	114.300
2-3/16	2.1875	55.563	_____	3.2283	82	_____	4.5275	115
_____	2.2047	56	3-1/4	3.250	82.550	4-9/16	4.562	115.888
_____	2.244	57	_____	3.2677	83	4-5/8	4.625	117.475
2-1/4	2.250	57.150	_____	3.3071	84	_____	4.7244	120
_____	2.2835	58	3-5/16	3.312	84.1377	4-3/4	4.750	120.650
2/5-16	2.312	58.738	_____	3.3464	85	4-7/8	4.875	123.825
_____	2.3228	59	3-3/8	3.375	85.725	_____	4.9212	125
_____	2.3622	60	_____	3.3858	86	5	5.000	127
2-3/8	2.375	60.325	_____	3.4252	87	_____	5.1181	130
_____	2.4016	61	3-7/16	3.438	87.313	5-1/4	5.250	133.350
2-7/16	2.438	61.913	_____	3.4646	88	5-1/2	5.500	139.700
_____	2.4409	62	3-1/2	3.500	88.900	_____	5.5118	140
_____	2.4803	63	_____	3.5039	89	5-3/4	5.750	146.050
2-1/2	2.500	63.500	_____	3.5433	90	_____	5.9055	150
_____	2.5197	64	3-9/16	3.562	90.4877	6	6.00	152.400
_____	2.559	65	_____	3.5827	91	6-1/4	6.250	158.750
2-9/16	2.562	65.088	_____	3.622	92	_____	6.2992	160
_____	2.5984	66	3-5/8	3.625	92.075	6-1/2	6.500	165.100
2-5/8	2.625	66.675	_____	3.6614	93	_____	6.6929	170
_____	2.638	67	3-11/16	3.6875	93.663	6-3/4	6.750	171.450
_____	2.6772	68	_____	3.7008	94	7	7.000	177.800
2-11/16	2.6875	68.263	_____	3.7401	95	_____	7.0866	180
_____	2.7165	69	3-3/4	3.750	95.250	_____	7.4803	190
2-3/4	2.750	69.850	_____	3.7795	96	7-1/2	7.500	190.500
_____	2.7559	70	3-13/16	3.8125	96.838	_____	7.8740	200
_____	2.7953	71	_____	3.8189	97	8	8.000	203.200
2-13/16	2.8125	71.438	_____	3.8583	98	_____	8.2677	210
_____	2.8346	72	3-7/8	3.875	98.425	8-1/2	8.500	215.900
_____	2.8740	73	_____	3.8976	99	_____	8.6614	220
2-7/8	2.875	73.025	_____	3.9370	100	9	9.000	228.600
_____	2.9134	74	3-15/16	3.9375	100.013	_____	9.0551	230
2-15/16	2.9375	74.613	_____	3.9764	101	_____	9.4488	240
_____	2.9527	75	4	4.000	101.600	9-1/2	9.500	241.300
_____	2.9921	76	4-1/16	4.062	103.188	_____	9.8425	250
3	3.000	76.200	4-1/8	4.125	104.775			
_____	3.0315	77	_____	4.1338	105			
3-1/16	3.062	77.788	4-3/16	4.1875	106.363			

U.S. STANDARD GAUGE CHART							
Gauge	Decimal Size	Gauge	Decimal Size	Gauge	Decimal Size	Gauge	Decimal Size
7	.188"	14	.078"	21	.034"	28	.016"
8	.172"	15	.070"	22	.031"	29	.014"
9	.156"	16	.063"	23	.028"	30	.013"
10	.141"	17	.056"	24	.025"	31	.011"
11	.125"	18	.050"	25	.022"		
12	.109"	19	.044"	26	.019"		
13	.094"	20	.038"	27	.017"		

Prevailing Torque Locknuts



Grade 8 • Cad and Waxed

Auveco Part No.	Thread Size	Hex Width	Unit Pkg.
12697	1/4"-20 USS	7/16"	50
12705	1/4"-28 SAE	7/16"	50
12698	5/16"-18 USS	1/2"	50
12706	5/16"-24 SAE	1/2"	50
12699	3/8"-16 USS	9/16"	50
12707	3/8"-24 SAE	9/16"	50
12700	7/16"-14 USS	11/16"	50
12708	7/16"-20 SAE	11/16"	50
12701	1/2"-13 USS	3/4"	25
12709	1/2"-20 SAE	3/4"	25
12710	9/16"-18 SAE	7/8"	25
12703	5/8"-11 USS	15/16"	10
12711	5/8"-18 SAE	15/16"	10
12704	3/4"-10 USS	1-1/8"	10

Hexagon Machine Screw Nuts



Auveco Part No.	Thread Size	Hex Width	Unit Pkg.
Zinc Plated Steel			
727	6-32	5/16"	100
728	8-32	11/32"	100
729	10-32	3/8"	100
730	10-24	3/8"	100
731	12-24	7/16"	100
733	1/4"-20	7/16"	100



Reversible Lock Nuts
Grade 2
Zinc Plated

Auveco Part No.	Thread Size	Hex Width	Unit Pkg.
11740	1/4"-20	7/16"	100
11741	5/16"-18	1/2"	100
11742	3/8"-16	9/16"	50
11743	1/2"-13	3/4"	25
11744	5/8"-11	15/16"	25

Hexagon Machine Screw Nuts
Double Chamfered - Plain Brass



Auveco Part No.	Thread Size	Hex Width	Unit Pkg.
3868	10-24 USS	3/8"	100

Slotted Hex Nuts

Zinc Finish



Auveco Part No.	Thread Size	Hex Width	Slot Width	Unit Pkg.
12722	1/2"-20	3/4"	5/32"-3/16"	50
12723	5/8"-18	15/16"	3/16"-15/64"	25

Nylon Insert Lock Nuts



Grade 2
Zinc Plated

Auveco Part No.	Thread Size	Hex Width	Unit Pkg.
9535	8-32	11/32"	100
9536	10-24 USS	3/8"	100
9537	10-32 SAE	3/8"	100
9538	12-24	7/16"	100
9539	1/4"-20 USS	7/16"	100
9540	1/4"-28 SAE	7/16"	100
9541	5/16"-18 USS	1/2"	50
9542	5/16"-24 SAE	1/2"	50
9543	3/8"-16 USS	9/16"	50
9544	3/8"-24 SAE	9/16"	50
9545	7/16"-14 USS	5/8"	50
9546	7/16"-20 SAE	5/8"	50
9547	1/2"-13 USS	3/4"	50
9548	1/2"-20 SAE	3/4"	50
15863	5/8"-11 USS	15/16"	25
15864	5/8"-18 SAE	15/16"	25
15865	3/4"-10 USS	1-1/8"	25

NUTS

Finished USS (Coarse) & SAE (Fine) Hexagon Nuts
Zinc Plated



Auveco Part No.	Thread Size	Hex Width	Unit Pkg.	Auveco Part No.	Thread Size	Hex Width	Unit Pkg.
3541	1/4"-20 USS	7/16"	100	3549	1/2"-13 USS	3/4"	100
3542	1/4"-28 SAE	7/16"	100	3550	1/2"-20 SAE	3/4"	100
3543	5/16"-18 USS	1/2"	100	8659	9/16"-12 USS	7/8"	50
3544	5/16"-24 SAE	1/2"	100	8660	9/16"-18 SAE	7/8"	50
3545	3/8"-16 USS	9/16"	100	8661	5/8"-11 USS	15/16"	50
3546	3/8"-24 SAE	9/16"	100	8662	5/8"-18 SAE	15/16"	50
3547	7/16"-14 USS	11/16"	100	8663	3/4"-10 USS	1-1/8"	50
3548	7/16"-20 SAE	11/16"	100				

Grade 5
Finished USS (Coarse) & SAE (Fine) Hex Nuts



Fully Certified For
S.A.E. J995 Standard
Proof Load: 120,000 PSI
C32 Max. Rockwell Hardness
Zinc Plated

Auveco Part No.	Thread Size	Hex Width	Unit Pkg.	Auveco Part No.	Thread Size	Hex Width	Unit Pkg.
15586	1/4"-20 USS	7/16"	100	15590	1/2"-13 USS	3/4"	50
15595	1/4"-28 SAE	7/16"	100	15599	1/2"-20 SAE	3/4"	50
15587	5/16"-18 USS	1/2"	100	16981	9/16"-12 USS	7/8"	25
15596	5/16"-24 SAE	1/2"	100	15591	5/8"-11 USS	15/16"	25
15588	3/8"-16 USS	9/16"	100	15600	5/8"-18 SAE	15/16"	25
15597	3/8"-24 SAE	9/16"	100	15592	3/4"-10 USS	1-1/8"	25
15589	7/16"-14 USS	11/16"	50	15601	3/4"-16 SAE	1-1/8"	25
15598	7/16"-20 SAE	11/16"	50	15594	1"-8 USS	1-15/32"	10

Sec. 8

NUTS

Finished USS (Coarse) & SAE (Fine) Hexagon Nuts

Zinc & Yellow Plated
High Alloy
Grade 8



Auveco Part No.	Thread Size	Hex Width	Unit Pkg.
9300	1/4"-20 USS	7/16"	100
9307	1/4"-28 SAE	7/16"	100
9301	5/16"-18 USS	1/2"	100
9308	5/16"-24 SAE	1/2"	100
9302	3/8"-16 USS	9/16"	100
9309	3/8"-24 SAE	9/16"	100
9303	7/16"-14 USS	11/16"	50
9310	7/16"-20 SAE	11/16"	50
9304	1/2"-13 USS	3/4"	50
9311	1/2"-20 SAE	3/4"	50
9305	5/8"-11 USS	15/16"	25
9312	5/8"-18 SAE	15/16"	25
9306	3/4"-10 USS	1-1/8"	25

**Grade 8
Finished USS (Coarse) & SAE (Fine) Hex Nuts**



Fully Certified
Proof Load: 150,000 PSI
C24-C32 Max. Rockwell Hardness For 1/4 thru 5/8
C26-C34 Max. Rockwell Hardness For 3/4 thru 1
Zinc & Yellow Plated

Auveco Part No.	Thread Size	Hex Width	Unit Pkg.
15640	1/4"-20 USS	7/16"	100
15649	1/4"-28 SAE	7/16"	100
15641	5/16"-18 USS	1/2"	100
15650	5/16"-24 SAE	1/2"	100
15642	3/8"-16 USS	9/16"	100
15651	3/8"-24 SAE	9/16"	100
15643	7/16"-14 USS	11/16"	50
15652	7/16"-20 SAE	11/16"	50
15644	1/2"-13 USS	3/4"	50
15653	1/2"-20 SAE	3/4"	50
16983	9/16"-12 USS	7/8"	25
15645	5/8"-11 USS	15/16"	25
15654	5/8"-18 SAE	15/16"	25
15646	3/4"-10 USS	1-1/8"	15

Refer to Assortments 1020, 1021, 1030 & 1031 in the green pages.



Display Boards

**Are Great Selling Tools.
Use Them To Help Boost
Your Sales.**

**Refer To The Color Pages
At The Front Of The
Catalog.**

**Do You Want Your Customers To
Know You Use The Best Body
Hardware & Specialty Fasteners
Available?**

**Promotional Products And Apparel
Bearing The  Logo Promote
Your Identity As A Professional.**

NUTS



**Brass Cylinder Head
And Manifold Stud Nuts**

Auveco Part No. USS	Thread Size	Hex Width	Height	Unit Pkg.
5317	5/16"-18	1/2"	17/64"	50



**Keps® Lock Washer & Nut
Zinc Plated**

Auveco Part No.	Thread Size	Hex Width	Unit Pkg.
3492	6-32	5/16"	100
3493	8-32	11/32"	100
3494	10-24	3/8"	100
3495	10-32	3/8"	100
3496	1/4"-20	7/16"	100
3497	1/4"-28	7/16"	100
3498	5/16"-18	1/2"	100
3499	5/16"-24	1/2"	100
3500	3/8"-16	9/16"	100
3501	3/8"-24	9/16"	100



Ziptwist Wing Nut

Auveco Part No.	Thread Size	O.D.	Height	Finish	Unit Pkg.
18531	6mm	5/8"	7/32"	Black	50



**Washer Base Wing Nuts
Zinc Alloy**

Auveco Part No.	Thread Size	Wing Spread	Overall Height	Washer O.D.	Unit Pkg.
10036	1/4"-20	1"	1/2"	3/4"	50



Square Nuts

Auveco Part No.	Thread Size	Width	Finish	Unit Pkg.
3249	3/16"-24	3/8"	Bright Zinc	100
3250	1/4"-20	7/16"	Bright Zinc	100



**Cage Nuts
Phosphate Plated**

Auveco Part No.	Thread Size	Fits Sq. Hole	Panel Range	Unit Pkg.
3144	1/4"-20	3/8"	.064-.105"	50
10773	1/4"-20	3/8"	.064-.105"	25
3798	5/16"-18	1/2"	.023-.063"	50



**Spin Lock Nuts
With Serrations**



Auveco Part No.	Thread Size	Flange O.D.	Hex Width	Unit Pkg.
-----------------	-------------	-------------	-----------	-----------

Standard Flange - Zinc Plated

14878	8-32"	15/32"	11/32"	100	
14873	10-24"	USS	1/2"	3/8"	100
14874	1/4"-20	USS	19/32"	7/16"	100
14875	5/16"-18	USS	11/16"	1/2"	100
14876	3/8"-16	USS	3/4"	9/16"	100
14877	7/16"-14	USS	15/16"	11/16"	50
17084	1/2"-13	USS	1"	3/4"	25

Large Flange - Black Phosphate

2769	1/4"-20	USS	11/16"	7/16"	100
5167	5/16"-18	USS	13/16"	1/2"	100
5596	3/8"-16	USS	7/8"	9/16"	100



**Wing Nuts
Nickel Plated**

Auveco Part No.	Size	Unit Pkg.
3741	1/4"-20	100
3743	3/8"-16	50



**Self-Locking
Wing Nuts
Bright Zinc Chromate**

Auveco Part No.	Size	Unit Pkg.
9846	1/4"-20	100

Free Spinning Washer Nuts



Auveco Part No.	Thread Size	Washer O.D.	Hex Size	Height	Plating	O.E.M. No.	Unit Pkg
16770	#10-24	3/8"	5/16"	11/64"	Zinc & Yellow	383255-S36	100
16771	#10-32	3/8"	5/16"	11/64"	Zinc & Yellow		100
16772	1/4"-20	1/2"	7/16"	3/16"	Zinc		50
15345	1/4"-20	5/8"	7/16"	9/32"	Zinc & Yellow	3866846, 385400	50
15347	1/4"-20	7/8"	7/16"	5/16"	Phosphate	45334, 6023204, 6025004	50
15350	5/16"-18	3/4"	1/2"	3/8"	Phosphate	6025007	50
15351	3/8"-16	7/8"	9/16"	7/16"	Phosphate	376785	25

For metric sizes of free spinning washer nuts, refer to page 64.

**Pushnut Bolt Retainers
For Threaded Fasteners**



Auveco Part No.	Bolt Dia.	O.D.	Finish	Unit Pkg.
16851	9/64"	(#6) 11/32"	Zinc	100
10085	5/32"	(#8) 3/8"	Phos	100
16852	3/16"	(#10) 7/16"	Phos	100
10086	1/4"	1/2"	Zinc	100
10087	5/16"	5/8"	Zinc	100
9297	3/8"	25/32"	Zinc	100
9298	7/16"	27/32"	Zinc	100
9299	1/2"	15/16"	Zinc	100

For an Assortment of Pushnut Bolt Retainers see Fit-Kit No. 6164

**Washer Lock Nuts
Zinc Plated**



Auveco Part No.	Thread Size	Hex Width	O.D.	Unit Pkg.
2554	6-32	5/16"	7/16"	100
2555	8-32	11/32"	15/32"	100
2556	10-32	3/8"	1/2"	100
2557	10-24	3/8"	1/2"	100
2558	10-24	3/8"	3/4"	100
2560	12-24	3/8"	3/4"	100
2561	1/4"-20	7/16"	19/32"	100
2562	1/4"-20	7/16"	13/16"	100
10764	5/16"-18	1/2"	13/16"	100

For an assortment of Washer Lock Nuts, see Fix-Kit 6043

**Flat Push-On Retainers
For Non-Threaded Fasteners**













Auveco Part No.	Stud Size	O.D.	Plating	Unit Pkg.
8861	1/16"	3/16"	Phos	100
8862	3/32"	3/16"	Phos	100
8863	1/8"	3/8"	Zinc	100
8864	5/32"	7/16"	Zinc	100
8865	3/16"	7/16"	Zinc	100
8867	240"	17/32"	Zinc	100
8868	1/4"	17/32"	Zinc	100
8869	5/16"	5/8"	Zinc	100
10374	3/8"	3/4"	Zinc	100
10375	1/2"	1"	Zinc	100
21080	5/8"	1"	Zinc	100

**Hex Pal Nuts
Plated**



Auveco Part No.	Thread Size	Hex Width	Unit Pkg.
3975	3/8"-24	9/16"	100
8858	1/2"-20	3/4"	100

THREAD CUTTING NUTS

 <p>3400 Zinc</p> <p>1/8" Stud Size 1/4" Hex</p> <p>UNIT PACKAGE: 200</p>	 <p>2895 Zinc</p> <p>1/8" Stud Size 5/16" Hex 17/32" Washer Diameter</p> <p>UNIT PACKAGE: 100</p>	 <p>3403 Zinc</p> <p>1/8" Stud Size 5/16" Hex 7/16" Washer Diameter</p> <p>UNIT PACKAGE: 200</p>	 <p>3405 Zinc</p> <p>1/4" Stud Size 7/16" Hex 11/16" Washer Diameter</p> <p>UNIT PACKAGE: 200</p>
 <p>3401 Zinc</p> <p>1/8" Stud Size 5/16" Hex</p> <p>UNIT PACKAGE: 200</p>	 <p>2896 Zinc</p> <p>3/16" Stud Size 3/8" Hex 5/8" Washer Diameter</p> <p>UNIT PACKAGE: 100</p>	 <p>3404 Zinc</p> <p>3/16" Stud Size 3/8" Hex 1/2" Washer Diameter</p> <p>UNIT PACKAGE: 200</p>	 <p>10733 Zinc</p> <p>5/16" Stud Size 1/2" Hex 7/8" Washer Diameter</p> <p>UNIT PACKAGE: 100</p>
 <p>3402 Zinc</p> <p>3/16" Stud Size 1/2" Hex</p> <p>UNIT PACKAGE: 200</p>	 <p>2897 Zinc</p> <p>1/4" Stud Size 7/16" Hex 19/32" Washer Diameter</p> <p>UNIT PACKAGE: 100</p>	 <p>8855 Zinc</p> <p>5/32" Stud Size 3/8" Hex 9/16" Washer Diameter</p> <p>UNIT PACKAGE: 100</p>	



Acorn Cap Nuts
Nickel Plated

Auveco Part No.	Thread Size	Hex Width	Height	Unit Pkg.
11179	8-32	5/16"	9/32"	100
11180	10-24	3/8"	11/32"	100
11181	10-32	3/8"	11/32"	100
11182	1/4"-20	7/16"	3/8"	50
11183	5/16"-18	9/16"	7/16"	50
11184	3/8"-16	5/8"	1/2"	25

For Nylon Coated Metric Acorn Nuts, refer to page 65.

Do You Want Your Customers To Know You Use The Best Body Hardware & Specialty Fasteners Available?

Promotional Products And Apparel Bearing The



Logo Promote Your

Identity As A Professional.

WHEEL STUDS & BOLTS

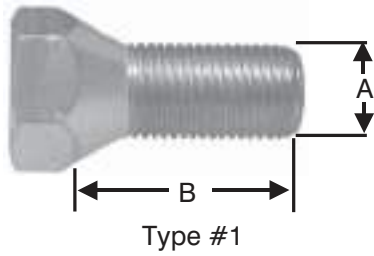

Type #1

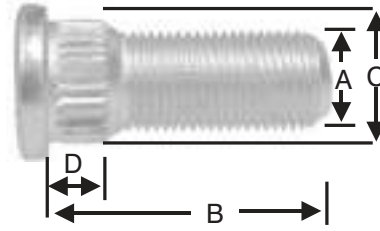

Type #2

Plated • Grade 8 Steel

UNIT PACKAGE: 10

Auveco No.	Type	Diameter (A)	Length (B)	Knurl Dia. (C)	Shoulder Length (D)	Application
14225	1	1/2"-20	1.070"/1.100"	N/A	N/A	Universal (3/4" Hex)
14227	2	1/2"-20	1.510"/1.540"	.618"/.628"	.310"/.330"	GM 76-55; Int. 80-67
14228	2	7/16"-20	1.380"/1.410"	.556"/.566"	.300"/.320"	GM 51-On
14231	2	1/2"-20	1.615"/1.635"	.618"/.628"	.440"/.460"	Ford 62-On
14235	2	1/2"-20	1.620"/1.650"	.618"/.628"	.630"/.650"	Dodge Tk 82-69; Ford 72-65; GMC 70-60
14237	2	1/2"-20	1.435"/1.465"	.556"/.566"	.420"/.440"	Ford 75-73
14241	2	7/16"-20	1.470"/1.500"	.460"/.470"	.333"/.343"	Chrysler 76-64; GM 84-62; Jeep 82-74
14243	2	1/2"-20	1.665"/1.695"	.618"/.628"	.720"/.750"	AMC 76-75; Chrysler 86-74
14244	2	1/2"-20	1.720"/1.750"	.615"/.625"	.445"/.460"	Ford 75-On

WHEEL NUTS



Type 1 (Outer)



Type 2 (Inner)



Type 3
(Stainless Steel Cap)



Type 4
(Stainless Steel Cap)



Type 5



Type 6
(Stainless Steel Cap)

Part No.	Unit Pkg.	Type	Size	Height	Hex	O.E.M. No.
8742	50	1	1/2"-20	9/16"	3/4"	Chrys: 2409826
8744	50	1	1/2"-20	5/8"	13/16"	GM: 413945, Ford: C0AZ-1012A
8746	50	1	7/16"-20	9/16"	3/4"	GM: 516637, Chrys: 2072728
11715	5	3	1/2"-20	1-1/16"	13/16"	GM: 414187
12520	5	2	3/4"-16 L.H. (Inner) 1-1/8"-16 L.H. (Outer)	2-7/32"	13/16" Sq.	Budd: 10709
12521	5	1	1-1/8"-16 L.H.	7/8"	1-1/2"	Budd: 37892
12522	5	2	3/4"-16 (Inner) R.H. 1-1/8"-16 (Outer) R.H.	2-7/32"	13/16" Sq.	Budd: 10708
12523	5	1	1-1/8"-16	7/8"	1-1/2"	Budd: 37891
12524	5	1	3/4"-16 L.H.	7/8"	1-1/2"	Budd: 37889
12525	5	1	3/4"-16	7/8"	1-1/2"	Budd: 37888
12617	5	5	12mm-1.5	23mm	19mm	Chrys: 6500092
12675	25	1	12mm-1.5	14mm	19mm	GM: 9590477
12695	5	4	12mm-1.5	34mm	19mm	GM: 10018202
12715	10	1	12mm-1.5	14mm	19mm	Chrys: 6500526
14253	10	1	12mm-1.25	16mm	21mm	Nissan: 40224-21001
17353	5	6	12mm-1.5	30mm	19mm	Chry: 6502738
18163	5	4	1/2"-20	1-11/32"	3/4"	Chrys: J4006956
19168	10	6	7/16"-20	1-3/32"	3/4"	GM: 414188, 9591855



1-1/8" Inner Cap Nuts

Zinc Plated
3/4"-16 Inner Thread; 1-1/8"-16 Outer Thread

Part No.	Type	Description	Dimensions							Unit Pkg.
			A	B	C	D	E	F	G	
12520	LH	For Steel Wheels	1-7/16"	2-7/32"	17/32"	1-3/16"	13/16"	1-13/32"	5
12522	RH	For Steel Wheels	1-7/16"	2-7/32"	17/32"	1-3/16"	13/16"	1-13/32"	5
15004	LH	For Steel/Alum. Combo	1-15/16"	2-5/8"	19/32"	1-7/32"	13/16"	1-13/32"	5
15009	RH	For Alum. Wheels; GR 8	1-21/32"	2-21/32"	5/8"	5/16"	1-1/8"	13/16"	1-13/32"	5
15010	LH	For Alum. Wheels; Gr 8	1-21/32"	2-21/32"	5/8"	5/16"	1-1/8"	13/16"	1-13/32"	5

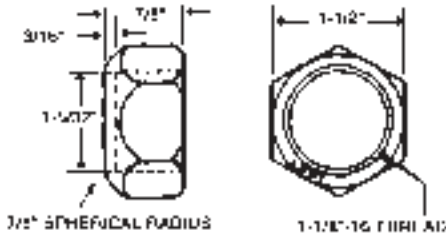

1-1/8" Outer Cap Nut



3/4" Outer Cap Nut

Single (3/4") Mounting
Front & Rear
Zinc Plated

Auveco Part No.	Zinc Plated Desc.	Unit Pkg.
12521	LH.....	5
12523	RH.....	5

Auveco Part No.	Desc.	Unit Pkg.
12524	LH.....	5
12525	RH.....	5

Flange Wheel Nuts



Auveco Part No.	Thread	Hex Size	Flange O.D.	Unit Pkg
15011	5/8-18(RH).....	1-1/8"	1-5/8"	10

Rim Clamp Nuts



Zinc Plated

Auveco Part No.	Thread	Hex Size	Unit Pkg.
15015	3/4"-10.....	1-1/4"	25

TRUCK WHEEL HARDWARE

Rim Studs Grade 8 • Zinc Plated

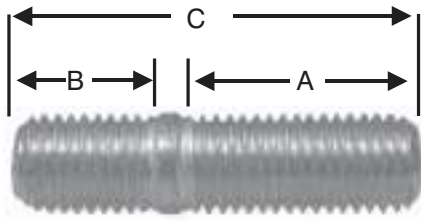

Auveco Part No.	A Dia. & Length	B Dia. & Length	C Overall Length	Unit Pkg.
15016	5/8"-11 USS x 1-5/8"	5/8"-11 USS x 13/16"	2-3/4"	10
15017	3/4"-10 USS x 1-13/16"	3/4"-10 USS x 7/8"	3"	25
15018	3/4"-10 USS x 1-7/8"	3/4"-10 USS x 1"	3-1/8"	25

Truck Wheel Hardware Interchange

The numbers listed in this interchange are cross referenced to the closest equivalent Auveco part. In some instances the parts are not identically the same; however, the Auveco part is designed to service the same application.

Part No.	Auveco Part No.	Part No.	Auveco Part No.	Part No.	Auveco Part No.	Part No.	Auveco Part No.	Part No.	Auveco Part No.
ALCOA		BUDD		DAYTON WALTHER					
5988-L	15010	10708	12522	08-853501	12523	5706	15018	W-11	12522
5988-R	15009	35337	15004	08-853502	12521	5735-L	15004	W-12	12520
BATCO		37888	12525	08-853701	12522	5735-R	15003	W-13	12523
13-3005-R	12522	37889	12524	08-853702	12520	5988-L	15010	W-14	12521
13-3008-L	15004	37891	12523	EUCLID		5988-R	15009	W-15	12525
13-3012-L	12521	37892	12521	4956-A	15017	GMC		W-16	12524
13-3013-L	12524	95188	15011	4958	15016	2201406	12522	W-159	15004
13-3026-L	15010	DAYTON		4963	15015	2201407	12520	W-246	15018
13-3026-R	15009	5715	15017	5549-L	12520	279670L	12521	W-486	15009
13-6002	15016	5716	15015	5549-R	12522	279670R	12523	W-487	15010
13-6003	15017	6654	15016	5552-L	12521	NUTURN			
13-6005	15018	8411	15018	5552-R	12523	W-5	15016		
13-8004	15015			5652-L	12524	W-6	15017		
				5652-R	12525	W-8	15015		

Sec. 9

TEENUT® FASTENERS

Round Base -3 Rivet or Nail Holes for Assembly
Material: Low Carbon Steel, Zinc Finish

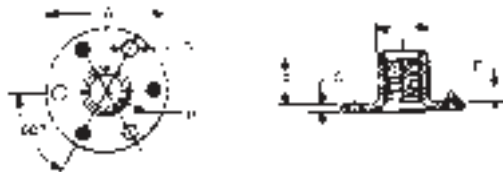

For applications into materials of high density and where repeated bolt removal and replacement is expected.



Auveco No.	Thread Size	A	B	C	D +.005	E	R	S	Unit Pkg.
18341	1/4-20	3/4	5/16	.311/.306	.098	5/64	19/64	.050	50
2262	3/8-16	1	1/2	.471/.466	.145	5/64	5/64	.075	100

Claw Prongs -Round Base

Material: Low Carbon Steel, Plain Finish

This Long Prong Teenut has six claw-like prongs that penetrate into wood, toe in, and grip so tightly that you have to drive it to back it out of its hole.



Auveco No.	Thread Size	A	B	C	D	S	Unit Pkg.
10729	10-24	3/4	9/32	.232/.227	13/64	.035	50
11324	1/4-20	3/4	5/16	.294/.289	15/64	.042	50
10730	1/4-20	3/4	7/16	.294/.289	15/64	.042	50
10731	5/16-18	7/8	3/8	.369/.364	19/64	.052	50
10732	3/8-16	1.0	7/16	.448/.443	11/32	.062	25

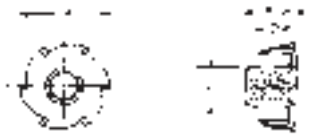

Claw Prongs -Slimline, Round Base

Material: Low Carbon Steel, Plain Finish

Recommended where superior retention in soft wood is required.



Auveco No.	Thread Size	A	B	C	D	S	Unit Pkg.
11325	1/4-20	3/4	5/16	.294/.289	15/64	.042	100
11326	5/16-18	7/8	3/8	.369/.364	19/64	.052	50
11327	3/8-16	1.00	7/16	.448/.443	11/32	.062	25

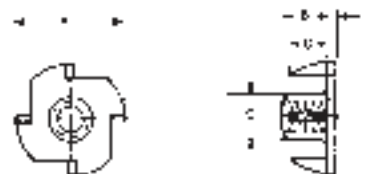

Claw Prongs -Slimline, Round Base

Material: 300 Series Stainless Steel, Plain Finish



Auveco No.	Thread Size	A	B	C	D	S	Unit Pkg.
17013	1/4-20	3/4"	5/16"	19/64"	3/16"	.047"	25

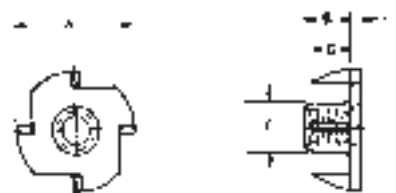

Straight Prongs -Round Base

Material: Low Carbon Steel, Plain Finish

This Teenut is recommended for thick material applications and applications requiring the top of the barrel to provide a bearing surface for mating parts.



Auveco No.	Thread Size	A	B	C	D	Type	S	Unit Pkg.
11328	6-32	9/16	15/64	.164/.157	1/8	3 Prongs	.020	50
11331	10-32	3/4	9/32	.232/.227	13/64	3 Prongs	.035	50
11332	1/4-20	3/4	5/16	.311/.306	15/64	4 Prongs	.050	50

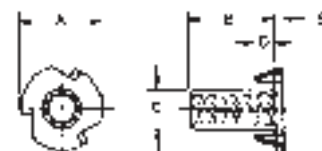



AUVECO THIN SHEET NUTSERT® INSERTS

Sec. 9

U.S.S., S.A.E. & Metric -Steel & Aluminum

Threaded Inserts For Thin Material

The Auveco Thin Sheet Nutsert® has been designed to provide a highly efficient method of securing threads from one side of the work in materials generally too thin to support threads. Its performance has been proven in plastic, aluminum, mild steel and fiberglass withstanding high loads without vibrating or loosening under extreme operating conditions. The Auveco Thin Sheet Nutsert® is a tension fastener with high pull out, insuring no rotation or vibration where a cover plate is used. The system's unique blind tooling installs TSNs at consistent rates using unskilled labor.

How It Works

The Thin Sheet Nutsert®, held securely by the tool, is placed into a prepared hole. Upon the tool's actuation, the threaded portion is pulled until the fastener's wall collapses radially outward, clinching it tight against the sheet. The tool is withdrawn, leaving the Thin Sheet Nutsert® ready to receive a bolt or screw. This complete operation takes only a few seconds and can be performed by anyone.

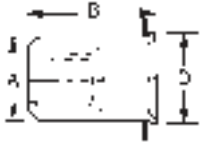

1. Insert TSN into prepared hole.



2. Engage the tool

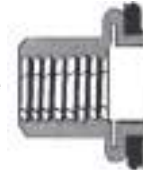

3. TSN installed With standard head configuration

Strength Tests: Torque Strength -With an attaching part over the Thin Sheet Nutsert®, offering a bearing surface, the TSN will remain intact past the point of the screw or bolt breaking (head torqued off). In almost all cases the threads of the TSN will remain undistorted and serviceable -an exception to this statement is when an extremely high tensile bolt is used.

Steel: 1010 Low Carbon Steel, Type 11 Class 3 with Zinc Plate, Clear Chromate

Aluminum: Aluminum Alloy 5056, Plain Finish, Metric Class 6H, U.S. Class 2B

To Set Nutserts®, Use Tool 11805 & Conversion Kits Listed On Page 92.

U.S.S. & S.A.E.

Auveco Part No.		Unit Pkg.	Thread Size After Installation	Recommended Grip Range	A Max.	B Max.	D Ref.	Hole Size	Drill Size
Steel	Aluminum								
11310	13476	50	6-32 U.S.S.	.020-.080"	.249"	.410"	.287"	.250-.254"	1/4"
11315	13477	100	6-32 U.S.S.	.020-.080"	.249"	.410"	.287"	.250-.254"	1/4"
11311	—	50	8-32 U.S.S.	.020-.080"	.249"	.410"	.287"	.250-.254"	1/4"
11316	—	100	8-32 U.S.S.	.020-.080"	.249"	.410"	.287"	.250-.254"	1/4"
11312	13480	50	10-24 U.S.S.	.020-.130"	.280"	.465"	.320"	.281-.285"	9/32"
11317	13481	100	10-24 U.S.S.	.020-.130"	.280"	.465"	.320"	.281-.285"	9/32"
12978	—	50	10-32 S.A.E.	.020-.130"	.280"	.465"	.320"	.281-.285"	9/32"
12979	—	100	10-32 S.A.E.	.020-.130"	.280"	.465"	.320"	.281-.285"	9/32"
11313	—	25	1/4"-20 U.S.S.	.030-.165"	.347"	.610"	.415"	.375-.379"	3/8"
11318	—	100	1/4"-20 U.S.S.	.030-.165"	.347"	.610"	.415"	.375-.379"	3/8"
11314	—	25	5/16"-18 U.S.S.	.040-.200"	.499"	.720"	.540"	.500-.504"	1/2"
11319	—	100	5/16"-18 U.S.S.	.040-.200"	.499"	.720"	.540"	.500-.504"	1/2"
16785	—	15	3/8"-16 U.S.S.	.040-.200"	.499"	.720"	.540"	.500-.504"	1/2"

Regular Pitch Metric

Auveco Part No.		Unit Pkg.	Thread Size After Installation	Recommended Grip Range "GR"	A Max.	B Max.	D Ref.	Hole Size	Drill Size
Steel	Aluminum								
12980	—	50	M4-.7	.020-.080" .508/2.030mm	.249" 6.32mm	.410" 10.41mm	.287" 7.29mm	.250-.254" 6.35/6.45mm	1/4"
12981	—	100	M4-.7	.020-.080" .508/2.030mm	.249" 6.32mm	.410" 10.41mm	.287" 7.29mm	.250-.254" 6.35/6.45mm	1/4"
12982	—	50	M5-.8	.020-.130" .508/3.300mm	.280" 7.11mm	.465" 11.81mm	.320" 8.13mm	.281-.285" 7.14/7.24mm	9/32"
12983	—	100	M5-.8	.020-.130" .508/3.300mm	.280" 7.11mm	.465" 11.81mm	.320" 8.13mm	.281-.285" 7.14/7.24mm	9/32"
12984	13494	25	M6-1.0	.030-.165" .762/4.190mm	.374" 9.50mm	.610" 15.49mm	.415" 10.54mm	.375-.379" 9.53/9.63mm	3/8"
12985	13495	100	M6-1.0	.030-.165" .762/4.190mm	.374" 9.50mm	.610" 15.49mm	.415" 10.54mm	.375-.379" 9.53/9.63mm	3/8"
12986	—	25	M8-1.25	.040-.200" 1.020/5.080mm	.499" 12.67mm	.720" 18.29mm	.540" 13.72mm	.500-.504" 12.71/12.80mm	1/2"
12987	—	100	M8-1.25	.040-.200" 1.020/5.080mm	.499" 12.67mm	.720" 18.29mm	.540" 13.72mm	.500-.504" 12.71/12.80mm	1/2"

Sec. 9 LARGE FLANGE THIN SHEET NUTSERT® INSERTS

U.S.S., S.A.E. & Metric -Steel & Aluminum



The Large Flange system provides captive threads in materials too thin to independently support threads, or where costly tapping operations are to be eliminated. The Large Flange fastener can be used as a rivet to join materials that will ultimately have a separate component attached.

Materials: Low Carbon Steel, Zinc Plated
(Metric: Zinc & Yellow Plated)
Aluminum Alloy, Plain Finish

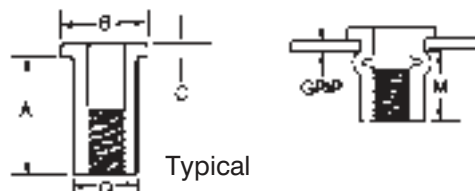

To Set 8-32, 10-24 and 10-32 Large Flange Nutserts®, use tool 11805 and conversion kits listed on page 92. 1/4"-20, 5/16"-18 and 3/8"-16 Large Flange Nutserts® require a pneumatic tool for installation. They **cannot** be set with 11805.

U.S.S. & S.A.E.

Auveco Part No.		Unit Pkg.	Thread Size	Grip Range	Hole Size	A +.015	B +.015	C (NOM)	D +.000 -.004	M (Ref.)
Aluminum	Steel									
16177	16187	50	8-32 U.S.S.	.010-.075"	.221-.226"	.438"	.357"	.032"	.221"	.300"
16178	16188	50	10-24 U.S.S.	.010-.080"	.250-.256"	.531"	.406"	.038"	.250"	.380"
16179	16189	50	10-24 U.S.S.	.080-.130"	.250-.256"	.594"	.406"	.038"	.250"	.390"
16180	16190	25	10-32 S.A.E.	.010-.080"	.250-.256"	.531"	.406"	.038"	.250"	.380"
.....	16191	25	10-32 S.A.E.	.080-.130"	.250-.256"	.594"	.406"	.038"	.250"	.390"
16182*	16192*	25	1/4"-20 U.S.S.	.020-.080"	.332-.338"	.625"	.475"	.058"	.332"	.450"
16183*	16193*	25	1/4"-20 U.S.S.	.080-.140"	.332-.338"	.687"	.475"	.058"	.332"	.450"
16184*	16194*	25	5/16"-18 U.S.S.	.030-.125"	.413-.423"	.750"	.665"	.062"	.413"	.505"
.....	16195*	25	5/16"-18 U.S.S.	.125-.200"	.413-.423"	.875"	.665"	.062"	.413"	.555"
16789*	10	3/8"-16 U.S.S.	.030-.115"	.490-.500"	.844"	.781"	.088"	.490"	.585"
.....	16788*	10	3/8"-16 U.S.S.	.115-.200"	.490-.500"	.938"	.781"	.088"	.490"	.595"

***Cannot be set with Auveco tool 11805**
Requires pneumatic tool

Regular Pitch Metric

Auveco Part No.		Unit Pkg.	Thread Size	Grip Range	Hole Size	A ±.015	B ±.015	C (NOM.)	D+.000 -.004	M (Ref.)
Aluminum	Steel									
.....	16978	25	M6-1.0	.020-.118" .5-3.0mm	.358" 9.1mm	.630" 16mm	.510" 13mm	.059" 1.5mm	.356" 9mm	.450" 11.5mm

NUTSERT® INSERTS

U.S.S. & S.A.E. THREAD

The Auveco Nutsert® was developed to offer both the production-oriented designer and engineer a unique and versatile anchor nut-type insert for high-speed installation. This Auveco system gives the designer the option to design for **blind** or **open** applications, eliminating and simplifying his design problems.

The Auveco Nutsert® system provides a cost-saving method of installing clean, load-bearing steel threads in castings, fiberglass, fiberboard, plastics, wood or almost any ductile material more than .030" thick.

A simple hand tool installs the Nutsert®...it is ready for use in seconds... no finishing is required after installation.

Auveco Nutsert's® advanced design offers unlimited grip range in a minimum of sizes...inventory is minimized to one body dimension per thread size; ideally suited for blind...buried... and through holes. The ingenious "taper-lock" principle locks-in the Nutsert® preventing spin or twist; installs in flat or curved surfaces and is self-tightening with repeated use. The unique design of the installation tool eliminates marring of the parent material surface.

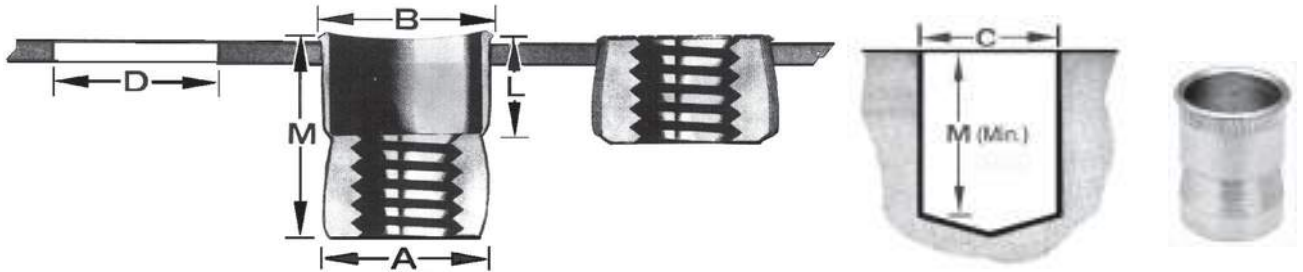

Material: Mild Steel, Tin Plated
Minimum Grip: .030"

To Set Nutserts® Use Tool 11805 & Conversion Kits Listed On Page 92.

Auveco Part No.	Unit Pkg.	Thread Size (Class 2B)	A	B	L	M	C	D	Recommended Nominal Hole Size	Weight Per Thousand (In Lbs.)
10264 10265 10266	25 100 1000	6-32 U.S.S.	.218"	.238"	.185"	.370"	Diameters vary with material density in blind application	Dependent upon material thickness and application	7/32"	1.50
10267 10268 10269	25 100 1000	8-32 U.S.S.	.249"	.264"	.185"	.370"			1/4"	2.00
10270 10271 10272	25 100 1000	10-24 U.S.S.	.280"	.300"	.185"	.370"			9/32"	2.25
10273 10274 10275	25 100 1000	10-32 S.A.E.	.280"	.300"	.185"	.370"			9/32"	2.25
10276 10277 10278	25 100 1000	1/4"-20 U.S.S.	.374"	.398"	.255"	.510"			3/8"	6.00
10279 10280	25 100	1/4"-28 S.A.E.	.374"	.398"	.255"	.510"			3/8"	6.00
10282 10283 10284	10 100 500	5/16"-18 U.S.S.	.499"	.524"	.305"	.610"			1/2"	12.87
10285 10286	10 100	5/16"-24 S.A.E.	.499"	.524"	.305"	.610"			1/2"	12.87
10288 10289 10290	10 50 100	3/8"-16 U.S.S.	.561"	.590"	.370"	.740"			9/16"	18.00

Sec. 9

NUTSERT® HAND TOOL & US & METRIC CONVERSION KITS



11805
Nutsert® Hand Tool
For regular and thin sheet Nutserts®
(Does not include any conversion kits)
Hand Tool only with wrench

UNIT PACKAGE: 1

Conversion Kits For
No. 11805 Gun

Size	Use Tool 11805 with Auveco Conversion Kit Listed
6-32 U.S.S.	11807
8-32 U.S.S.	11808
10-32 S.A.E.	11809
10-24 U.S.S.	11810
1/4-20 U.S.S.	11811
1/4-28 S.A.E.	11812
5/16-18 U.S.S.	11813
5/16-24 S.A.E.	11814
3/8-16 U.S.S.	11815
M4-.7	12988
M5-.8	12989
M6-1.0	12990
M8-1.25	12991

Unit Package: 1



11806

Nutsert® Tool Kit
(Complete in metal case)
Includes hand tool 11805, nose piece wrench, and conversion kits (nose piece & mandrel) for the following sizes: 6-32, 8-32, 10-24, 10-32, 1/4-20 & 5/16-18.

UNIT PACKAGE: 1

16341

Metric Nutsert® Tool Kit
(Complete in metal case)
Includes hand tool 11805, nose piece wrench, and conversion kits (nose piece & mandrel) for the following sizes: M4-.7, M5-.8, M6-1.0 (2 kits) & M8-1.25.

UNIT PACKAGE: 1



15544

Mandrel Puller
Replacement Mandrel Puller
For Auveco 11805 Nutsert® Tool
1/4-28 Left-Hand Thread

UNIT PACKAGE: 1

THREAD REPAIR INSERTS

Here's the easy way to repair stripped threads.



Easy Installation/4 Simple Steps
Instructions Must Be Followed Exactly

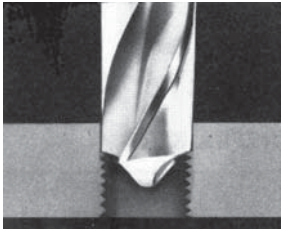

1 Drill out old threads, using standard drill.

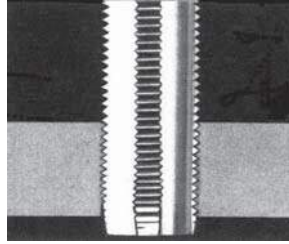

2 Tap new threads, using standard tap

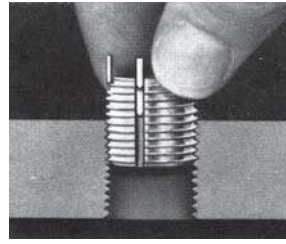

3 Screw in insert until slightly below surface. "kees" act as depth stop.

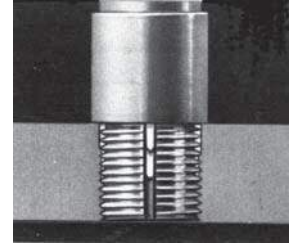

4 Drive "Kees" down with several light taps on installation tool.

Features:

- Installed with standard drills and taps.
- No pre-winder tool required.
- Impossible to cross thread while installing.
- No tang break-off.
- May be used in virtually any material...aluminum, magnesium, cast iron, cold rolled steel and plastic

- Provide high strength and reliability. One length per size provides maximum pullout strength.
- Positive mechanical lock against rotation.
- Breaks Grade 8 bolts in test after test.
- Easy to remove.



5 Installed Insert.

Thinwall Inserts

Auveco Part No.	Internal Thread Size (Bolt Size)	External Thread Size	No. of Kees	Insert Length	Drill Size	Tap Size	Professional Installation Tool Part No.	Inserts Per Unit Package
12374	10-24	5/16"-18	2	5/16"	"I"	5/16"-18	4*
17515								25
17516								50
12375								4*
17517	10-32	3/8"-16	2	3/8"	"Q"	3/8"-16	12394	25
17518								50
12376								4*
17519	1/4"-20	7/16"-14	4	7/16"	"X"	7/16"-14	12395	25
17520								50
12377	1/4"-28	9/16"-12	4	9/16"	33/64"	9/16"-12	12397	4*
17521								25
12378	5/16"-18	5/8"-11	4	5/8"	37/64"	5/8"-11	4*
17522								25
17523	5/16"-24	1/2"-13	4	1/2"	29/64"	1/2"-13	12396	50
12379								4*
17524	3/8"-16	1/2"-13	4	1/2"	29/64"	1/2"-13	12396	25
12380								3*
17525	3/8"-24	9/16"-12	4	9/16"	33/64"	9/16"-12	12397	25
17526								50
12381	7/16"-14	9/16"-12	4	9/16"	33/64"	9/16"-12	12397	3*
17527								25
12382	7/16"-20	5/8"-11	4	5/8"	37/64"	5/8"-11	3*
17528								25
12383	1/2"-13	5/8"-11	4	5/8"	37/64"	5/8"-11	3*
17529								25
12384	1/2"-20	5/8"-11	4	5/8"	37/64"	5/8"-11	2*
17530								15
17531	1/2"-20	5/8"-11	4	5/8"	37/64"	5/8"-11	25
12385								2*
17532	15							

*Contains Economy Drive Tool No. 12404

For an Assortment of Thin Wall Inserts, see Fix-Kit No. 6176

THREAD REPAIR INSERTS



Heavy Duty Thread Repair Inserts

Auveco Part No.	Internal Thread Size (Bolt Size)	External Thread Size	No. of Kees	Insert Length	Drill Size	Tap Size	Professional Installation Tool Auveco Part No.†	Inserts Per Unit Package
17238	10-24	3/8"-16	2	.31"	"Q"	3/8"-16	◆	4
17239	10-32							4
17240	1/4"-20	7/16"-14	2	.37"	"X"	7/16"-14	◆	4
17241	1/4"-28							4
17242	5/16"-18	1/2"-13	4	.43"	29/64"	1/2"-13	◆	4
17243	5/16"-24							4
17244	3/8"-16	9/16"-12	4	.50"	33/64"	9/16"-12	◆	3
17245	3/8"-24							3
17246	7/16"-14	5/8"-11	4	.62"	37/64"	5/8"-11	◆	3
17247	7/16"-20							3
17248	1/2"-13	3/4"-16	4	.62"	45/64"	3/4"-16	◆	2
17249	1/2"-20							2
16159	5/8"-11	7/8"-14	4	.87"	53/64"	7/8"-14	16163	2
17533								15
16160	5/8"-18							2
17534								15
16161	3/4"-10	1-1/8"-12	4	1.12"	1-1/16"	1-1/8"-12	16164	2
17535								10
16162	3/4"-16							2
17536								10

† Not Packaged with the Thread Repair Inserts

◆ Professional tool not available. Can be set with 12404 Economy Drive Tool one kee at a time.

Metric Thread Repair Inserts®

Auveco Part No.	Internal Thread Size (Bolt Size)	External Thread Size	No. of Kees	Insert Length	Drill Size	Tap Size	Professional Installation Tool Auveco Part No.†	Inserts Per Unit Package
12386	M5-0.8	M8-1.25	2	.315"	"H"	M8-1.25	12399	3*
17537								15
12387	M6-1.0	M10-1.25	2	.394"	"S"	M10-1.25	12400	3*
17538								15
12389	M8-1.0	M12-1.25	4	.472"	27/64"	M12-1.25	◆	2*
17539								10
12390	M8-1.25							2*
17540								10
12391	M10-1.25	M14-1.5	4	.551"	1/2"	M14-1.5	◆	2*
17541								10
12392	M10-1.5							2*
17542								10

*Contains Economy Drive Tool 12404

† Not Packaged with the Thread Repair Inserts

◆ Professional tool not available. Can be set with 12404 Economy Drive Tool one kee at a time.

THREAD REPAIR INSERTS

Professional Insert Installation Tool



Auveco Tool No.	Installs Insert Sizes (Internal Thread)
12394	1/4"-20 & 1/4"-28
12395	5/16"-18 & 5/16"-24
12396	3/8"-16 & 3/8"-24
12397	7/16"-14 & 7/16"-20

Auveco Tool No.	Installs Insert Sizes (Internal Thread)
12399	M5-0.8
12400	M6-1.0
16163	5/8"-11 H.D. & 5/8"-18 H.D.
16164	3/4"-10 H.D. & 3/4"-16 H.D.

Economy Driver Tool



No. 12404

Will install approximately 10 Inserts. Use with Thinwall Inserts up to 1/2" and 10mm Internal Diameter and Heavy Duty Inserts up to 1/2" Internal Diameter

UNIT PACKAGE: 5

Thread Repair Insert Assortments

No. 12405 "Assortment Kit" Contains			No. 12406 "Assortment Kit" Contains			No. 12407 "Assortment Kit" Contains		
Auveco Part No.	Qty	Size	Auveco Part No.	Qty	Size	Auveco Part No.	Qty	Size
12374	3	10-24	12375	3	10-32	12387	2	M6-1.0
12376	3	1/4"-20	12377	3	1/4"-28	12389	2	M8-1.0
12378	3	5/16"-18	12379	3	5/16"-24	12390	2	M8-1.25
12380	3	3/8"-16	12381	3	3/8"-24	12391	2	M10-1.25
12404	2	Installation Tools	12404	2	Installation Tools	12404	1	Installation Tool

Sec. 9

HELICAL THREAD REPAIR INSERTS & KITS

For Repairing Stripped Or Damaged Threads

The most effective and universally accepted method of thread repair.

Inserts quickly and permanently restores stripped, worn or damaged threads to their original size and condition.



Easy to use... just 1. Drill 2. Tap 3. Install
Now you're back to the original size and
the original size fastener can be used.



When threads become stripped, worn or damaged for any reason, the strength and reliability are greatly reduced. When this happens on critical threaded assemblies, cars, and other types of equipment, it may become unsafe to operate.

These potentially dangerous situations are eliminated when the damaged thread is repaired with a thread repair insert. The threaded insert provides stronger, more reliable threads than the original tapped hole and at the same time eliminates the possibility of thread wear, seizing and corrosion.



Thread Size & Length	Kits		Insert	Metal Installation Tool	Tap		Required Drill Size		
	Contents: Number of inserts shown, one installation tool & one tap.				Auveco Part No.	Unit Pkg.		Auveco Part No.	Unit Pkg.
	Auveco Kit No.	Inserts Per Kit							
U.S.S. COARSE THREAD (18-8 Stainless Steel)									
10-24 x .285"	18621	10	18544	10	18571	1	18596	1	13/64"
1/4"-20 x .375"	18622	10	18545	10	18572	1	18597	1	17/64"
5/16"-18 x .469"	18573	1	18598	1	21/64"
3/8"-16 x .562"	18624	10	18547	10	18574	1	18599	1	25/64"
7/16"-14 x .656"	18548	10	18575	1	18600	1	29/64"
1/2"-13 x .750"	18626	5	18549	10	18576	1	18601	1	17/32"
5/8"-11 x .938"	18627	5	18550	10	18577	1	18602	1	21/32"
3/4"-10 x 1.125"	18551	5	18578	1	25/32"
S.A.E. FINE THREAD (18-8 Stainless Steel)									
10-32 x .285"	18629	10	18552	10	18579	1	18604	1	13/64"
1/4"-28 x .375"	18630	10	18553	10	18580	1	18605	1	17/64"
5/16"-24 x .469"	18554	10	18581	1	21/64"
3/8"-24 x .562"	18555	10	18582	1	18607	1	25/64"
7/16"-20 x .656"	18583	1	29/64"
1/2"-20 x .750"	18634	5	18557	10	18584	1	18609	1	33/64"
METRIC REGULAR PITCH (18-8 Stainless Steel)									
M6-1.00 x 9.0mm	18635	10	18558	10	18585	1	18610	1	1/4"
M8-1.25 x 12.0mm	18636	10	18559	10	18586	1	18611	1	21/64"
M9-1.25 x 13.5mm	10	18587	1	18612	1	"U"
M10-1.50 x 15.0mm	18561	10	18588	1	18613	1	13/32"
M11-1.50 x 16.5mm	18589	1	18614	1	29/64"
M12-1.75 x 18.9mm	18644	5	18565	5	18592	1	18617	1	31/64"
METRIC FINE PITCH (18-8 Stainless Steel)									
M10-1.25 x 15.0mm	18563	10	18590	1	13/32"
M11-1.25 x 16.5mm	18564	10	29/64"
M12-1.50 x 18.0mm	18566	5	18593	1	18618	1	31/64"
M12-1.25 x 18.0mm	18642	5	18567	5	18594	1	18619	1	31/64"
SPARK PLUG THREAD (Mild Carbon Steel)									
M14-1.25 x 3/8"	18568	2	18595	1	18620	Do Not Drill. Use Piloted Tap 18620
M14-1.25 x 1/2"			18569	2					
M14-1.25 x 3/4"			18570	2					

JACK NUTS®

Material - 1010 Steel - Zinc Plated

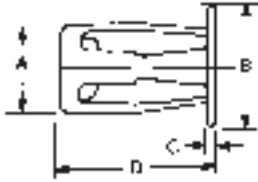

Type 1



Type 2



Type 3

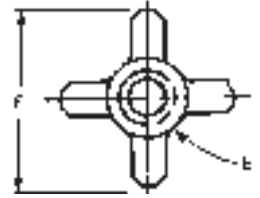

Auveco Part No.	Unit Pkg.	Type	Thread (E)	Body Dia. (A)	Head Dia. (B)	Cap Thick (C)	Overall Lgth (D)	Grip Range	Required Hole Dia.	Maximum Spread (F)**
13012	25	1	6-32	.318	.468	.073	.653	1/64"-3/16"	.315-.330	.660
13014	25	1	10-24	.382	.531	.073	.716	1/64"-3/16"	.385-.400	.760
13016	25	1	1/4"-20	.438	.625	.073	.731	1/64"-3/16"	.434-.450	.890
16235*	15	2	1/4"-20	.438	.625	.073	.731	1/64"-3/16"	.434-.450	.890
13017	25	1	1/4"-20	.438	.625	.073	.919	3/16"-3/8"	.434-.450	.890
16227	25	1	M4-.7	.318	.468	.073	.841	3/16"-3/8"	.318-.330	.720
16234•	25	3	M6-1.0	.438	.625	.073	.731	1/64"-3/16"	.438-.450	.890

* Raintite Sealer

** Spread Varies With Material Thickness

• Sealer

See Jack Nut® Installation Tools On Next Page

Special Purpose Jack Nuts®

Auveco Part No.	O.E.M. Number	Type	Thread	Finish	O.E.M. Application	Unit Pkg.
12995	GM: 367292 Chry: 6031438	3	1/4-20	Zinc w/Sealer	GM Mirror Mounting Nut	25
12996	GM: 367292 Chry: 6031438	3	1/4-20	Zinc w/ Sealer	GM Mirror Mounting Nut	100
12998	GM: 1623436	2	M5-.8	Zinc w/Raintite	GM "J" Body Rack Mount	10
16230	GM: 5970995	1	M6-1.0	Zinc	License Plate Mounting Bracket	25
12997	GM: 1635218, 10014363	1	M6-1.0	Zinc	GM License Plate Nut	25
12999	GM: 14007940	2	M6-1.0	Zinc w/Raintite	GM "X" & "Y" Roof Rack Mounting Nut	10

Sec. 9

JACK NUT® INSTALLATION TOOLS

Part No. 14157
Professional
Jacknut®
Installation Tool

UNIT PACKAGE: 1

An economical tool for rapidly installing Jack Nuts in any material. Takes interchangeable screw rods. Just screw rod into Jack Nut, push into hole, squeeze to set and remove. Sets all size Jack Nut Threaded Inserts.

Part No. 14156
Friction Wrench



For use when installing a limited quantity of Jack Nuts. Insert the wrench between the screw and the head of the fastener, hold wrench and run in screw to set Jack Nut.

UNIT PACKAGE: 10

Tool comes with 16856 (6-32 Thread) Installation Rod



Jacknut® Installation Rods

Use w/14157 Installation Tool



Auveco Part No.	Unit Pkg.	Thread
16856	1	6-32
14158	1	10-24
14159	1	1/4-20
14160	1	4mm
14161	1	5mm
14162	1	6mm



Mirror Mounting Screws And Jack Nuts

For additional information refer to listings on pages 21 and 52.

Auveco Part No.	Description	Unit Pkg.
13231	1/4-20 x 7/8" Screw (Phos.)	25
13232	1/4-20 x 7/8" Screw (Phos) & Jack Nut®	25
14947	M6 x 26mm Screw (Chrome)	25
14976	1/4-20 x 1-1/4" Screw (Stainless Steel)	25
14977	1/4-20 x 1-1/4" Screw (Stainless Steel) & Jack Nut®	10

RUBBER NUT INSERTS

Neoprene Rubber With A Brass Nut

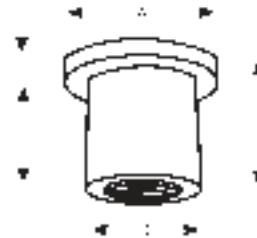

Part Number	Unit Pkg.	Thread	(A) Head Dia.	(B) Overall Length	(C) Shank Length	(D) Shank Dia.	(E) Head Height	Hole Size	Grip Range
19911	25	#6-32	.433	.496	.441	.311	.055	5/16	.015-.156
19917	15	5/16-18	.870	.721	.595	.626	.126	5/8	.015-.156
19918	15	M5-.8	.551	1.570	1.519	.375	.051	3/8	.808-1.182

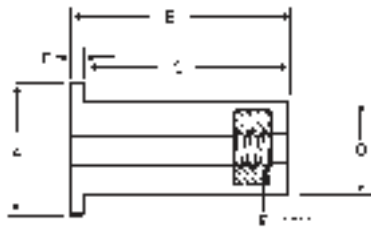

WELL NUTS®

Material - Neoprene with Captive Brass Nut



Auveco Part No.	Unit Pkg.	(E) Thread	(A) Head Dia.	(B) Overall Length	(C) Shank Length	(D) Shank Dia.	(F) Head Thick	Hole Size	Grip Range (For Wall Thickness)	O.E.M. Number	O.E.M. Application
13006	25	#6-32	.452	.499	.437	.312	.062	5/16	.015-.156
16236	25	#6-32	.554	.981	.946	.240	.035	1/4	.375-.607
16237	25	#8-32	.438	.499	.447	.312	.052	5/16	.015-.156	Chry: 6026166 GM: 347065	Rear Compt. Cover Support
13005	25	#8-32	.750	.575	.500	.312	.062	5/16	.015-.172	GM: 14048060	License Plate
16240	25	#10-24	.562	.767	.580	.375	.187	3/8	.030-.227	GM: 3876130	Voltage Reg & Dome Light
16246†	25	#10-32	.510	.400	.341	.375	.059	3/8	.015-.050	GM: 6264396 AMC: 4005237	Hatchback Window Brkt
13007	25	#10-32	.500	.554	.518	.377	.036	3/8	.015-.192
13009	10	#10-32	.562	.665	.625	.377	.040	3/8	.035-.232	GM: 12338025	Luggage Rack
17586	15	#10-32	.750	.703	.625	.375	.078	3/8	.030-.227
16244	25	#10-32	.750	.807	.620	.375	.187	3/8	.030-.227
13008	10	#10-32	.562	1.051	1.000	.375	.051	3/8	.312-.643
13004	25	1/4-20	.625	.641	.594	.500	.051	1/2"	.015-.111	GM: 528846 AMC: 4003120	Luggage Rack
16255	15	1/4-20	.635	.801	.750	.500	.051	1/2"	.187-.343
13010	10	1/4-20	.740	.829	.642	.500	.187	1/2"	.031-.187
16253	25	1/4-20	.635	1.051	1.000	.500	.051	1/2"	.250-.457	GM: 342271	Luggage Rack
13011	10	5/16-18	.875	.725	.600	.620	.125	5/8	.015-.187
16242	25	M5-.8	.500	.554	.518	.375	.036	3/8	.015-.192
16248	25	M5-.8	.562	.665	.625	.375	.040	3/8	.035-.232	GM: 14005097	Service Part
13000	10	M6-1.0 w/ss screw #10 Head	.787	.630	.579	.500	.051	1/2"	.015-.094	GM: 20130258, 14002811	Station Wagon Roof Rack
13001	50										
13002	10										
13003	50	M6-1.0	.787	.630	.579	.500	.051	1/2"	.015-.094	GM: 20130258, 14002811	Station Wagon Roof Rack
16251	25	M6-1.0	.630	.630	.579	.500	.051	1/2"	.015-.111	GM: 15505451 AMC: 8934201293	Luggage Rack License Plate
16252	25	M6-1.0	.750	.829	.642	.500	.187	1/2"	.031-.187	VW: 175 820 435	Luggage Rack
16254	25	M6-1.0	.635	1.051	1.000	.500	.051	1/2"	.250-.457
16256	10	M8-1.25	.875	.725	.600	.620	.125	5/8	.015-.156	AMC: 8934201493	Radiator Brkt.

† Comes with snap-in feature

TUBULAR TYPE NUTS

(LISTED BY STUD SIZE)

ILLUSTRATIONS ACTUAL SIZE



Twice Actual Size
13962
 Amber Nylon
 5/64" Stud Size
 Barrel Length: 7/32"
 Head Dia.: 7/32"
 Head Thick: 3/64"
 Fits Into 5/32" Hole
 UNIT PACKAGE: 50



Twice Actual Size
3776
 Phosphate
 3/32" Stud Size
 Panel Range: .032"-.040"
 Fits Into 1/8" Hole
 UNIT PACKAGE: 100



Twice Actual Size
3137
 Phosphate
 3/32" Stud Size
 Panel Range: .025"-.175"
 Fits Into 1/8" Hole
 UNIT PACKAGE: 100



11293
 (375890-S102)
 Green
 With Sealer
 1/8" Stud Size
 Panel Range: .035"-.045"
 Fits Into 3/16" Hole
 UNIT PACKAGE: 50



13964
 Natural Nylon
 1/8" Stud Size
 Barrel Length: 11/32"
 Head Dia.: 15/64"
 Head Thick: 1/32"
 Fits Into 11/64" Hole
 UNIT PACKAGE: 50



2595
 Phosphate
 1/8" Stud Size
 Panel Range: .040"-.045"
 Fits Into 3/16" Hole
 UNIT PACKAGE: 100



3777
 Phosphate
 1/8" Stud Size
 Panel Range: .038"-.044"
 Fits Into 5/32" Hole
 UNIT PACKAGE: 100



2611
 Phosphate
 1/8" Stud Size
 Panel Range: .030"-.036"
 Fits Into 5/32" Hole
 UNIT PACKAGE: 100



5854
 (373528-S32)
 (6000605)
 Phosphate
 1/8" Stud Size
 Panel Range: .025"-.045"
 Fits Into 3/16" Hole
 UNIT PACKAGE: 100



5195
 (375480-S100)
 (3783794)
 Phosphate
 1/8" Stud Size
 Panel Range: .036"-.046"
 Fits Into 1/4" Hole
 UNIT PACKAGE: 100



13965
 (4006316)
 White Nylon
 5/32" Stud Size
 Barrel Length 1/4"
 Head Dia. 1/4"
 Head Thick. 1/32"
 Fits Into 3/16" Hole
 UNIT PACKAGE: 100



8545
 Phosphate
 5/32" Stud Size
 Panel Range: .062"-.068"
 Fits Into 7/32" Hole
 UNIT PACKAGE: 100



8546
 Phosphate
 5/32" Stud Size
 Panel Range: .049"-.055"
 Fits Into 7/32" Hole
 UNIT PACKAGE: 100



10073
 (6000558)
 Phosphate
 3/16" Stud Size
 Panel Range: .038"-.044"
 Fits Into 7/32" Hole
 UNIT PACKAGE: 100



2565
 Phosphate
 3/16" Stud Size
 Panel Range: .020"-.032"
 Fits Into 7/32" Hole
 UNIT PACKAGE: 100



13966
 (8934-201-767)
 Black Nylon
 3/16" Stud Size
 Barrel Length 17/64"
 Head Dia. 5/16"
 Head Thick. 1/32"
 Fits Into 17/64" Hole
 UNIT PACKAGE: 100



8578
 White Nylon
 #10 Thread Screw
 Fits Into 5/16" Hole
 UNIT PACKAGE: 50

























5196
 (354341-S)
 Phosphate
 1/4" Stud Size
 Panel Range: .034"-.040"
 Fits Into 9/32" Hole
 UNIT PACKAGE: 100



19537
 (6000258)
 Phosphate
 1/4" Stud Size
 Panel Range: .030"-.034"
 Fits Into 5/16" Hole
 UNIT PACKAGE: 50

For An Assortment Of Tubular Nuts See Fix-Kits 6007 & 6502 in the green pages.

Flat Nuts
(ILLUSTRATIONS ACTUAL SIZE)

For Screws		For Studs	
 1896 Phosphate #2-56 Machine Screw Size 7/32" x 3/8" UNIT PACKAGE: 100	 1899 Phosphate #8-32 Machine Screw Size 1/2" x 7/8" UNIT PACKAGE: 100	 2098 Phosphate 1/16" Stud Size 7/32" x 3/8" UNIT PACKAGE: 100	 2426 Phosphate 3/16" Stud Size 3/8" x 5/8" UNIT PACKAGE: 100
 2089 Phosphate #6-32 Machine Screw Size 5/16" x 1/2" UNIT PACKAGE: 100	 2091 Phosphate #8-32 Machine Screw Size 5/16" x 1/2" UNIT PACKAGE: 100	 2100 Phosphate 3/32" Stud Size 1/4" x 7/16" UNIT PACKAGE: 100	 2103 Phosphate 3/16" Stud Size 3/8" x 5/8" UNIT PACKAGE: 100
 1898 Phosphate #6-32 Machine Screw Size 1/2" x 7/8" UNIT PACKAGE: 100	 1900 Phosphate #10 Tapping Screw Size 1/2" x 7/8" UNIT PACKAGE: 100	 1906 Phosphate .100" or 3/32" Stud Size 7/32" x 7/16" UNIT PACKAGE: 100	 2105 Phosphate 1/4" Stud Size 7/16" x 5/8" UNIT PACKAGE: 100
 18209 Phosphate #8 Tapping Screw Size 5/16" x 1/2" UNIT PACKAGE: 100	 2092 Phosphate #10-24 Machine Screw Size 7/16" x 3/4" UNIT PACKAGE: 100	 2099 Phosphate 1/8" Stud Size 5/16" x 9/16" UNIT PACKAGE: 100	 3138 Phosphate 5/16" Stud Size 1/2" x 11/16" UNIT PACKAGE: 100
 5563 Phosphate No. 8 Tapping Screw Size 13/32" x 5/8" UNIT PACKAGE: 100	 1912 Phosphate #12 Tapping Screw Size 1/2" x 3/4" UNIT PACKAGE: 100	 2102 Phosphate 5/32" Stud Size 3/8" x 9/16" UNIT PACKAGE: 100	 3139 Phosphate 3/8" Stud Size 9/16" x 3/4" UNIT PACKAGE: 100
 3793 Phosphate No. 8 Tapping Screw Size 13/32" x 5/8" UNIT PACKAGE: 100	 1903 Phosphate 1/4"-20 Machine Screw Size 9/16" x 1" UNIT PACKAGE: 100	 1905 Phosphate 5/32" Stud Size 7/16" x 3/4" UNIT PACKAGE: 100	

Sec. 9**“U” & “J” Type Nuts By Screw Size**

(ILLUSTRATIONS ACTUAL SIZE)

**9625**
Phosphate#6 Screw Size
Panel Range: .090" - .110"
Ctr Of Hole To Edge: 9/32"

UNIT PACKAGE: 100

**21007**
Phosphate#6-32 Screw Size
Panel Range: .045" - .062"
Center of Hole To Edge: 5/16"

UNIT PACKAGE: 50

**5571**
Phosphate#8 Screw Size
Panel Range: .025" - .040"
Ctr Of Hole To Edge: 1/4"

UNIT PACKAGE: 100

**5836**
Phosphate#8 Screw Size
Panel Range: .025" - .035"
Ctr Of Hole To Edge: 3/8"

UNIT PACKAGE: 100

**2346**
Phosphate#8 Screw Size
Panel Range: .025" - .040"
Ctr Of Hole To Edge: 9/32"

UNIT PACKAGE: 100

**3796**
(9428481)
Phosphate#8 Screw Size
Panel Range: .025" - .040"
Center Of Hole To Edge: 1/4"

UNIT PACKAGE: 100

**10666**
Phosphate#8 Screw Size
Panel Range: .025" - .035"
Ctr Of Hole To Edge: 11/32"

UNIT PACKAGE: 100

**11292**
(445429,
9422552)
Phosphate#8 Screw Size
Panel Range: .045" - .062"
Center Of Hole To Edge: 3/8"

UNIT PACKAGE: 50

**11768**
(388248-S-36B)
Phosphate#8 Screw Size
Panel Range: .075" - .090"
Cntr Of Hole To Edge: 9/32"

UNIT PACKAGE: 50

**3778**
Phosphate#8 Screw Size
Panel Range: .035" - .051"
Center Of Hole To Edge: 5/16"

UNIT PACKAGE: 100

**19826**
(382163-S)
Phosphate#8 Screw Size
Panel Range: .145" - .160"
Center Of Hole To Edge: 9/32"
Replaces Auveco 11063

UNIT PACKAGE: 50

**8337**
Phosphate#8-18 Screw Size
Panel Range: .025" - .040"
Center Of Hole To Edge: 3/8"

UNIT PACKAGE: 50

**14822**
(25527289)
PhosphateM4.2-1.41 (#8) Screw Size
Panel Range: .094" - .109"
Center Of Hole To Edge: 7/32"

UNIT PACKAGE: 50

**14814**
(N803183-S32)
PhosphateM4.2-1.41 (#8) Screw Size
Panel Range: .094" - .156"
Center Of Hole To Edge: 1/2"

UNIT PACKAGE: 25

**18208**
Phosphate#10 Screw Size
Panel Range: .015" - .085"
Center Of Hole To Edge: 11/32"

UNIT PACKAGE: 100

**11429**
Phosphate#10 Screw Size
Panel Range: .015" - .060"
Center Of Hole To Edge: 15/32"

UNIT PACKAGE: 50

For an assortment of “U” & “J” Nuts, see Fix-Kits 6007 & 6502 in the green pages.

“U” & “J” Type Nuts By Screw Size

(ILLUSTRATIONS ACTUAL SIZE)



2303
Phosphate

#10 Screw Size
Panel Range: .027"-.045"
Center Of Hole To Edge: 3/16"

UNIT PACKAGE: 100



5576
Phosphate

#10 Screw Size
Panel Range: .045"-.062"
Center Of Hole To Edge: 13/32"

UNIT PACKAGE: 100



2420
Phosphate

#14 Screw Size
Panel Range: .028"-.056"
Center Of Hole To Edge: 15/32"

UNIT PACKAGE: 100



3797
Phosphate

#10 Screw Size
Panel Range: .045"-.062"
Center Of Hole To Edge: 13/32"

UNIT PACKAGE: 100



8341
Phosphate

#10 Screw Size
Panel Range: .025"-.060"
Center Of Hole To Edge: 11/32"

UNIT PACKAGE: 100



2293
(9431647)
Phosphate

1/4"-20 Machine Screw Size
Panel Range: .064"-.125"
Center Of Hole To Edge: 9/16"

UNIT PACKAGE: 100



1913
Phosphate

#10 Screw Size
Panel Range: .020"-.051"
Center Of Hole To Edge: 15/32"

UNIT PACKAGE: 50



5197
Phosphate

#10-24 Machine Screw Size
Panel Range: .045"-.062"
Center Of Hole To Edge: 9/16"

UNIT PACKAGE: 100



1907
Phosphate

5/16"-10 Tapping Screw Size
Panel Range: .032"-.064"
Center Of Hole To Edge: 1/2"

UNIT PACKAGE: 50



3770
Phosphate

#10 Screw Size
Panel Range: .030"-.037"
Center Of Hole To Edge: 3/8"

UNIT PACKAGE: 100



1910
Phosphate

#12 Screw Size
Panel Range: .037"-.051"
Center Of Hole To Edge: 1/2"

UNIT PACKAGE: 50



2422
Phosphate

#10 Screw Size
Panel Range: .025"-.064"
Center Of Hole To Edge: 3/8"

UNIT PACKAGE: 100



2057
Phosphate

#14 Screw Size
Panel Range: .032"-.040"
Center Of Hole To Edge: 1/2"

UNIT PACKAGE: 100

**For the most
up-to-date
information on new
items available from
Auveco, refer to the**

**"Hot New Items"
section of the
Auveco website
(www.auveco.com)**

Sec. 9**SPRING TYPE "U" NUTS****10064**
Phosphate#6 Screw Size
Panel Range: .025"-.125"
Center Of Hole To Edge: 3/8"

UNIT PACKAGE: 50

**10065**
Phosphate#8 Screw Size
Panel Range: .025"-.125"
Center Of Hole To Edge: 3/8"

UNIT PACKAGE: 25

16267Same As 10065 Except For Unit
Package Quantity

UNIT PACKAGE: 100

**9880**
(9424837, 9431530;
381818-S2)
Phosphate#8 Screw Size
Panel Range: .025"-.150"
Center Of Hole To Edge: 3/8"
GM, Ford

UNIT PACKAGE: 100

**9879**
(9440178, 11504531; 381863-S2)
Phosphate#8 Screw Size
Panel Range: .025"-.150"
Center Of Hole To Edge: 5/8"
GM, Ford

UNIT PACKAGE: 100

**20582**
(9433156)
Phosphate#8 Screw Size
Panel Range: .125" - .250"
Center Of Hole To Edge: 3/8"
GM

UNIT PACKAGE: 100

**10066**
Phosphate#10 Screw Size
Panel Range: .025"-.125"
Center Of Hole To Edge: 11/32"

UNIT PACKAGE: 25

**15752**
Phosphate#10 Screw Size
Panel Range: .025"-.150"
Center Of Hole To Edge: 9/16"

UNIT PACKAGE: 50

**9881**
(9425491)
Phosphate#14 Screw Size
Panel Range: .025"-.150"
Center Of Hole To Edge: 5/16"
GM

UNIT PACKAGE: 100

**10067**
Phosphate#14 Screw Size
Panel Range: .025"-.125"
Center Of Hole To Edge: 3/8"

UNIT PACKAGE: 25

**You Can E-Mail
Your New Item
Suggestions To
mail@auveco.com****"U" TYPE SPECIAL NUTS****14526**
(N802538-S100)
Green Phosphate#8 Screw Size
Panel Range: 1/16"-5/32"
Center Of Hole To Edge: 5/16"
17/32" Wide, 51/64" Long
Ford

UNIT PACKAGE: 50

**14527**
(10041588, 25530441)
Phosphate#8 Screw Size
Panel Range: 1/16"-3/16"
Center Of Hole To Edge: 19/32"
35/64" Wide, 1-1/32" Long
GM

UNIT PACKAGE: 50

**14750**
(Toyota: 53879-14010-A, 53879-14020,
53879-22030; GM: 94841226;
Mazda: LA01-56-135)Nylon "U" Nut Fender/Wheel
Housing Applications#10 Screw Size
20mm Wide
31mm LongPanel Range: Up to 1mm
Center of Hole To Edge: 11mm
Toyota, Geo Prizm & Nova
And Mazda

UNIT PACKAGE: 15

19669

Same As 14750 Except For Packing

UNIT PACKAGE: 25

**20956**
(90467-05114)
Black NylonBumper & Fender Apron
Nylon "U" NutScrew Size: M5.5 (#12)
Width: 20mm, Length: 36mm
Center Of Hole to Edge: 14mm
Panel Range: Up To 1mm
Lexus & Toyota

UNIT PACKAGE: 10

“U” TYPE SPECIAL NUTS



19809
(650870AA)
Natural Nylon

#8 (M4.2) Screw Size
Panel Range: 1mm-4.25mm
Center Of Hole To Edge: 10mm
Chrysler

UNIT PACKAGE: 25



19163
Zinc

M4.2 (#8) Screw Size
3 Position “U” Nut
Panel Range: Up To 3/32"
Center Of Hole To Edge: 15/32"
27/32" Wide, 7/8" Long

UNIT PACKAGE: 25



19165
Phosphate

M4.2(#8) Screw Size
Multi-Position “U” Nut
Panel Range: Up To 5/64"
Center of Hole to Edge: 25/64"
3/4" Wide, 11/16" Long

UNIT PACKAGE: 25



19166
(1260888,
25556911)
Phos. & Blue

M4.2 (#8) Screw Size
Multi-Position “U” Nut
Panel Range: 1/16"-5/64"
Center Of Hole To Edge: 7/16"
Windshield Defroster Nozzle &
Various Instrument Panel
Applications
GM 1984-On

UNIT PACKAGE: 25



19162
(1638575,
25512688)
Zinc

M4.2 (#8) Screw Size
Panel Range: .035"-.049"
Center Of Hole To Edge: 9/16"
GM

UNIT PACKAGE: 25



19164
Phosphate

M4.2 (#8) Screw Size
4 Position “U” Nut
Panel Range: Up To 5/32"
Center Of Hole To Edge: 7/16"
15/16" Wide, 29/32" Long

UNIT PACKAGE: 25



10401
(545920, 9837022)
Phosphate

#8 Screw Size
Panel Range: 3/16"
Center Of Hole To Edge: 9/32"
Headlight Bezel To Grille “U” Nut
Front Side Marker, Radio/Tape
Player & Various Instrument Panel
Applications
GM 1977-On

UNIT PACKAGE: 50



“J” Type Cage Nuts
Phosphate Finish

Center Auveco Part No.	Screw Size	Panel Range	Of Hole To Edge	Unit Pkg.
5586	1/4"-20 USS	.032/.093"	1/2"	50
3616	5/16"-18 USS	.087-.093"	9/16"	25
5589	5/16"-18 USS	.087-.093"	9/16"	50
5170	3/8"-16 USS	.050/.090"	9/16"	25

Sec. 9**EXTRUDED "U" NUTS**

(Foldover Nuts)

**10048**(45262)
Phosphate#8-32 Screw Size
Panel Range: .025"-.150"
Center Of Hole To Edge: 3/8"
Ford

UNIT PACKAGE: 50

**10050**(45263-S2)
Phosphate1/4"-20 Screw Size
Panel Range: .025"-.150"
Center Of Hole To Edge: 17/32"
Ford

UNIT PACKAGE: 25

**12265**(45264-S2)
Phosphate5/16"-18 Screw Size
Panel Range: .040"-.125"
Center Of Hole To Edge: 9/16"
Ford

UNIT PACKAGE: 50

**18898**(45262)
Phosphate#8-32 Screw Size
Panel Range: .079"-.118"
Center Of Hole To Edge: 3/8"
Ford

UNIT PACKAGE: 50

**10051**(45267; 1494257)
Phosphate1/4"-20 Screw Size
Panel Range: .025"-.150"
Center Of Hole To Edge: 25/32"
Ford, GM

UNIT PACKAGE: 50

**8377**(1480909)
Phosphate5/16"-18 Screw Size
Panel Range: .060"-.090"
Center Of Hole To Edge: 9/16"
GM

UNIT PACKAGE: 50

**15677**152273)
Phosphate#10-24 Screw Size
Panel Range: .025"-.125"
Center Of Hole To Edge: 15/32"
GM

UNIT PACKAGE: 50

**8375**(152266)
Phosphate5/16"-18 Screw Size
Panel Range: .025"-.060"
Center Of Hole To Edge: 9/16"
GM

UNIT PACKAGE: 50

**8372**(152267)
Phosphate5/16"-18 Screw Size
Panel Range: .120"-.150"
Center Of Hole To Edge: 9/16"
GM

UNIT PACKAGE: 50

**8359**(1480627, 1494252)
Phosphate1/4"-20 Screw Size
Panel Range: .025"-.150"
Center Of Hole To Edge: 17/32"
GM

UNIT PACKAGE: 50

**10053**(Chry: 6023171; Ford: 45264)
Phosphate5/16"-18 Screw Size
Panel Range: .025"-.150"
Center Of Hole To Edge: 9/16"
Ford

UNIT PACKAGE: 50

**10830**(1494253)
Phosphate5/16"-18 Screw Size
Panel Range: .025"-.150"
Center Of Hole To Edge: 5/8"
GM

UNIT PACKAGE: 50

EXTRUDED "U" NUTS
(Foldover Nuts)



8814
(1494258;
379831-S)
Phosphate

5/16"-18 Screw Size
Panel Range: .025"-.150"
Center Of Hole To Edge: 27/32"
GM, Ford

UNIT PACKAGE: 25



10052
(10008002;
45268-S2)
Phosphate

5/16"-18 Screw Size
Panel Range: .025"-.150"
Center Of Hole To Edge: 7/8"
GM, Ford

UNIT PACKAGE: 25



10054
(1494254, 12337873,
45265-S2)
Phosphate

3/8"-16 Screw Size
Panel Range: .050"-.200"
Center Of Hole To Edge: 3/4"
GM, Ford

UNIT PACKAGE: 25



10055
(45269)
Phosphate

3/8"-16 Screw Size
Panel Range: .050"-.200"
Center Of Hole To Edge: 1-1/8"
Ford

UNIT PACKAGE: 25

Metric Extruded "U" Nuts



18337
(GM: 11500654;
Ford: N623330-S2)
Zinc Organic

M4-.7 Screw Size
Panel Range: .60mm-3.8mm
(.030"-.150")
Center of Hole to Edge:
9.5mm (3/8")
GM, Ford

UNIT PACKAGE: 50



11625
(11500655)
Phosphate

M4-.7 Screw Size
Panel Range: .80mm-4.00mm
(.030"-.160")
Center Of Hole To Edge:
13.5mm (17/32")
GM

UNIT PACKAGE: 50



20339
(11516397)
Zinc Organic

M4.2-1.41 (#8) Screw Size
Locking Thread
Panel Range: .5mm-2.0mm
(.020"-.079")
Ctr of Hole to Edge: 10mm (25/64")
GM

UNIT PACKAGE: 50



21040
(11513599)
Zinc Organic

M4.2-1.41 (#8) Screw Size
Locking Thread
Panel Range: .65mm-3.8mm
(.025"-.150")
Ctr. Of Hole To Edge: 9.5mm (3/8")
GM

UNIT PACKAGE: 25



18338
(GM: 11505596;
Ford: N623331-S2)
Phosphate

M5-.8 Screw Size
Panel Range: .60mm-3.8mm
(.030"-.150")
Cntr Of Hole To Edge: 11mm (7/16")
GM, Ford

UNIT PACKAGE: 50



11626
(11500657)
Phosphate

M5-.8 Screw Size
Panel Range: .80mm-4.00mm
(.030"-.160")
Cntr Of Hole To Edge: 15.8mm (5/8")
GM

UNIT PACKAGE: 50



21539
(GM: 9114472)
Blue Nylon

M5.5 (#12) Screw Size
Panel Range: Up To 3.5mm (.138")
Center Of Hole To Edge:
8mm (5/16")

Use With Auveco 21541
GM

UNIT PACKAGE: 25



21540
(GM: 24449408)
Orange Nylon

M5.5 (#12) Screw Size
Panel Range: Up To 2mm (.079")
Center Of Hole To Edge:
12mm (15/32")

Use With Auveco 21541
GM & Saab

UNIT PACKAGE: 25

Sec. 9

EXTRUDED "U" NUTS

(Foldover Nuts)



16846
(6502152)
Phosphate

M6-1.0 Screw Size
Tri-Lobular Locking Thread
Panel Range: .80mm-4.00mm
(.030"-.160")
Cntr Of Hole To Edge:
12mm (15/32")
Chrysler

UNIT PACKAGE: 50



16842
(11504047;
N802331-S53)
Phosphate

M6-1.0 Screw Size
Panel Range: 3.4mm-6.3mm
(.140"-.250")
Center Of Hole To Edge:
13.5mm (17/32")
GM & Ford

UNIT PACKAGE: 25



18449
(Chrys: 6101308;
Ford: N800854-S2)
Phosphate

M6-1.0 Screw Size
Locking Thread
Panel Range: .80mm-4.00mm
(.030"-.160")
Center Of Hole To Edge:
13.5mm (17/32")
Chrysler

UNIT PACKAGE: 50



11864
(11503714,
11503716)
Phosphate

M6-1.0 Screw Size
Panel Range: .80mm-4.00mm
(.030"-.160")
Center Of Hole To Edge:
13.5mm (17/32")
GM

UNIT PACKAGE: 50



12669

1016937, 11503957;
N623332-S2,
-S53 & -S100
Phosphate

M6-1.0 Screw Size
Panel Range: .80mm-4.00mm
(.030"-.160")
Center Of Hole To Edge:
13.5mm (17/32")
GM, Ford

UNIT PACKAGE: 25



18881

(21095560)
Zinc
Cobalt Black

M6-1.0 Screw Size
Panel Range: 3.5mm-4.0mm
(.140"-.160")

Ctr of Hole to Edge: 13.5mm (17/32")
GM Saturn 1991-On

UNIT PACKAGE: 10



12666

(11504978)
Zinc Organic

M6-1.0 Screw Size
Panel Range: 3.4mm-6.3mm
(.135"-.250")

Ctr of Hole to Edge: 14.5mm (9/16")
GM

UNIT PACKAGE: 25



20416

(11516372)
Zinc Organic

M6-1.0 Screw Size
Panel Range: 2.0mm-5.0mm
(.079" - .197")

Center Of Hole To Edge:
14.5mm (9/16")
GM

UNIT PACKAGE: 25



19144

(11505048)
Black Phosphate

M6-1.0 Screw Size
Panel Range: 3.4mm-6.3mm
(.134"-.250")
Center Of Hole To Edge:
19mm (3/4")
GM Saturn

UNIT PACKAGE: 15



12575

(11503715,
11508241,
11609385)
Phosphate

M6-1.0 Screw Size
Panel Range: .80mm-4.0mm
(.030"-.160")
Ctr of Hole to Edge:
19.5mm (25/32")
GM

UNIT PACKAGE: 25



16322

(14040999)
Phosphate

M6-1.0 Screw Size
Panel Range: 1.0mm-2.5mm
(.045"-.095")

Ctr of Hole to Edge:
19.5mm (25/32")
GM

UNIT PACKAGE: 50



19480

(N805889-S100)
Phosphate

M6-1.0 Screw Size
Panel Range: 4.3mm-5.6mm
(.172"-.219")

Center of Hole To Edge:
21mm (13/16")
Ford

UNIT PACKAGE: 15

EXTRUDED "U" NUTS

Sec. 9

(Foldover Nuts)



11627

(11502785,
11504035)
Phosphate

M6.3-1.0 Screw Size
Panel Range: .80mm-4.00mm
(.030"-.160")
Ctr of Hole to Edge: 13.5mm (17/32")
GM

UNIT PACKAGE: 25



11629

(11500660, 11502617;
N623333-S2; 6101283)
Phosphate

M8-1.25 Screw Size
Panel Range: .80mm-4.00mm
(.030"-.160")
Cntr of Hole to Edge: 14.5mm (9/16")
GM, Ford, Chrysler

UNIT PACKAGE: 25



18401

(N801117-S100)
Black Phosphate

M8-1.25 Screw Size
Locking Thread
Panel Range: 4mm-7mm
(.157"-.276")
Center of Hole to Edge:
21mm (13/16")
Ford

UNIT PACKAGE: 25



11628

(9433043,
11500658)
Phosphate

M6.3-1.0 Screw Size
Panel Range: .80mm-4.00mm
(.030"-.160")
Ctr of Hole to Edge: 13.5mm (17/32")
GM

UNIT PACKAGE: 25



11630

(11500661, 11503317, 11516150;
N623343-S2 & S100)
Phosphate

M8-1.25 Screw Size
Panel Range: .80mm-4.50mm
(.030"-.170")
Ctr of Hole to Edge: 20mm (13/16")
GM, Ford

UNIT PACKAGE: 25



11631

(11500662, 22531616)
Phosphate

M10-1.50 Screw Size
Panel Range: 1.0mm-6.0mm
(.040"-.230")
Center of Hole to Edge: 19mm (3/4")
GM

UNIT PACKAGE: 25



12667

(11503455,
11504288)
Zinc Organic

M8-1.25 Screw Size
Panel Range: 1.50mm-5.50mm
(.060"-.216")
Ctr of Hole to Edge: 14.5mm (9/16")
GM

UNIT PACKAGE: 25



19644

(10084751)
Phosphate

M8-1.25 Screw Size
Panel Range: 1.7mm-5.5mm
(.067"-.217")
Ctr Of Hole To Edge:
28.5mm (1-1/8")
GM

UNIT PACKAGE: 15



18339

(GM: 11500663; Ford: N623344-S2)
Zinc Organic

M10-1.5 Screw Size
Panel Range: 1.5mm-5.5mm
(.060"-.215")
Ctr of Hole to Edge: 28mm (1-3/32")
GM, Ford

UNIT PACKAGE: 25

WASHERS



Countersunk Type Washers



Screw Size	I.D.	O.D.	Nickel Plated Brass			Black Zinc Plated Brass		Plain Brass	
			Unit Pkg. 100	Unit Pkg. 144	Unit Pkg. 1000	Part No.	Unit Pkg.	Part No.	Unit Pkg.
#4	9/64"	3/8"	612		7613				
#6	11/64"	7/16"	614	7143	7615	16011	100		
#8	13/64"	1/2"	616	7145	7616	16012	100		
#10	1/4"	19/32"	618	7147	7618	16013	100	16593	100
#12	9/32"	11/16"	619	7148					
#14	5/16"	25/32"	21389						



Flanged Type Countersunk Washers



Screw Size	I.D.	O.D.	Nickel On Brass Part No.	Black Zinc On Brass Part No.	Stainless Steel Part No.	Unit Pkg.
#6	5/32"	1/2"	3469		3470	100
#8	13/64"	5/8"	2515	16009	2597	100
#10	1/4"	11/16"	3471		3472	100

Flush Type Washers



Nickel Plated On Brass

Unit Pkg. 100	Unit Pkg. 144	Unit Pkg. 1000	Screw Size	I.D.	O.D.
602	7137	7624	#6	5/32"	11/32"
604	7138	7625	#8	3/16"	3/8"
16015		16016	#10	13/64"	15/32"

Nylon Finishing Washers

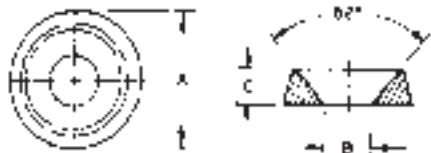

Available in natural or black nylon, these molded washers protect cabinets from scratching, cover misaligned holes, etc. May also be used as guides, bumpers and spacers.

Auveco Part No.	Screw Size	O.D. (A)	I.D. (B)	Thickness (C)	Color	Unit Pkg.
13717	#6	.437" (11.10mm)	.143" (3.63mm)	.100" (2.54mm)	Black	50
13718	#8	.515" (13.08mm)	.171" (4.34mm)	.115" (2.92mm)	Natural	50
13719	#8	.515" (13.08mm)	.171" (4.34mm)	.115" (2.92mm)	Black	50
13720	#10	.580" (14.73mm)	.191" (4.85mm)	.152" (3.86mm)	Natural	50
13721	#10	.580" (14.73mm)	.191" (4.85mm)	.152" (3.86mm)	Black	50
13723	#12	.609" (15.47mm)	.225" (5.72mm)	.160" (4.06mm)	Black	50
13724	#14	.683" (17.35mm)	.251" (6.38mm)	.183" (4.65mm)	Natural	50
13725	#14	.683" (17.35mm)	.251" (6.38mm)	.183" (4.65mm)	Black	50

WASHERS



USS (Wrought) Washers



Bolt Size	I.D.	O.D.	Thick-ness	Zinc Part No.	Plain Part No.	Unit Pkg.
3/16"	1/4"	9/16"	3/64"	8605		100
1/4"	5/16"	3/4"	1/16"	8606	3929	100
5/16"	3/8"	7/8"	1/16"	8607	3930	100
3/8"	7/16"	1"	5/64"	8608	3931	100
7/16"	1/2"	1-1/4"	5/64"	8609	3932	100
1/2"	9/16"	1-3/8"	7/64"	8610	3933	100
9/16"	5/8"	1-1/2"	7/64"	8611		100
5/8"	11/16"	1-3/4"	9/64"	8612	3935	50*
3/4"	13/16"	2"	5/32"	8613		50

* Unit Package quantity for 3935 is 100



SAE Washers

Zinc



Auveco Part No.	Bolt Size	I.D.	O.D.	Thick-ness	Unit Pkg.
3984	#6 (1/8")	5/32"	3/8"	3/64"	100
16721	#8 (5/32")	3/16"	7/16"	3/64"	100
3985	#10 (3/16")	7/32"	1/2"	1/16"	100
3986	1/4"	9/32"	5/8"	1/16"	100
3987	5/16"	11/32"	11/16"	1/16"	100
3988	3/8"	13/32"	13/16"	1/16"	100
3989	7/16"	15/32"	15/16"	1/16"	100
3990	1/2"	17/32"	1-1/16"	3/32"	100
3991	9/16"	19/32"	1-3/16"	3/32"	100
3992	5/8"	21/32"	1-5/16"	3/32"	100
3993	3/4"	13/16"	1-1/2"	1/8"	100
8621	7/8"	29/32"	1-3/4"	1/8"	100

High Strength Grade 8 Washers



1035 Steel - R/C38-45 Hardness
(For use with Grades 5 and 8 Bolts)
Zinc & Gold Dichromate Finish



USS Sizes						SAE Sizes					
Auveco Part No.	Bolt Size	I.D.	O.D.	Thick-ness	Unit Pkg.	Auveco Part No.	Bolt Size	I.D.	O.D.	Thick-ness	Unit Pkg.
12771	1/4"	5/16"	3/4"	.051/.080"	100	12781	1/4"	9/32"	5/8"	.055/.072"	100
12772	5/16"	3/8"	7/8"	.064/.104"	100	12782	5/16"	11/32"	11/16"	.055/.072"	100
12773	3/8"	7/16"	1"	.064/.104"	100	12783	3/8"	13/32"	13/16"	.055/.072"	100
12774	7/16"	1/2"	1-1/4"	.064/.104"	50	12784	7/16"	15/32"	59/64"	.055/.072"	50
12775	1/2"	9/16"	1-3/8"	.097/.121"	50	12785	1/2"	17/32"	1-1/16"	.097/.121"	50
12776	9/16"	5/8"	1-1/2"	.097/.121"	25	12786	9/16"	19/32"	1-3/16"	.097/.121"	50
12777	5/8"	11/16"	1-3/4"	.108/.160"	25	12787	5/8"	11/16"	1-5/16"	.122/.146"	25
12778	3/4"	13/16"	2"	.122/.177"	10	12788	3/4"	13/16"	1-15/32"	.122/.146"	25
12779	7/8"	15/16"	2-1/4"	.136/.192"	10	12789	7/8"	15/16"	1-3/4"	.136/.160"	15
						12790	1"	1-1/8"	2"	.136/.160"	10

Sec. 10

WASHERS



Spring Type Lock Washers Grade 5 Zinc

Auveco Part No.	Bolt Size	Unit Pkg.
5717	#6 (1/8")	200
5718	#8 (5/32")	200
5719	#10 (3/16")	200
5720	1/4"	200
5721	5/16"	200
5722	3/8"	200
5723	7/16"	200
5724	1/2"	200
8649	9/16"	100
8650	5/8"	100
14879	3/4"	50



High Alloy Lock Washers Grade 8 (For use with Grade 5 & 8 Bolts) Zinc & Yellow Dichromate

Auveco Part No.	Bolt Size	Unit Pkg.
11925	1/4"	100
11926	5/16"	100
11927	3/8"	100
11928	7/16"	50
11929	1/2"	50
11931	5/8"	50
11933	7/8"	25

For Fastener Assortments refer to Assortments 1020 and 1030 in the green pages.



Belleville Washers Phosphate and Oil

Auveco Part No.	Bolt Size	I.D.	O.D.	Thick-ness	Unit Pkg.
14847	1/4"-6mm	.255"	.500"	.022"	50
14848	1/4"-6mm	.255"	.500"	.038"	50
14850	5/16"-8mm	.317"	.625"	.047"	50
14851	3/8"-10mm	.380"	.750"	.034"	25
14852	3/8"-10mm	.380"	.750"	.056"	25
14853	7/16"-11mm	.441"	.886"	.045"	25
14854	1/2"-12mm	.505"	1.00"	.050"	25



Fender Washers Zinc Plated

Auveco Part No.	Bolt Size	I.D.	O.D.	Thick-ness	Unit Pkg.
2007	3/16"	7/32"	1/2"	3/64"	100
1183	3/16"	7/32"	3/4"	3/64"	100
16018	3/16"	7/32"	1"	3/64"	100
16019	3/16"	7/32"	1-1/4"	3/64"	50
2008	1/4"	9/32"	5/8"	3/64"	100
16020	1/4"	9/32"	1"	1/16"	100
2333	1/4"	9/32"	1-1/4"	1/16"	100
16021	1/4"	9/32"	1-1/2"	3/64"	50
1376	5/16"	21/64"	3/4"	1/16"	100
768	5/16"	11/32"	1-1/4"	3/64"	100
17095	5/16"	11/32"	1-1/4"	1/8"	25
1700	5/16"	11/32"	1-1/2"	3/64"	50
3553	3/8"	13/32"	1-1/4"	1/16"	100
2227	3/8"	13/32"	1-1/2"	3/64"	50
16022	3/8"	27/64"	1-5/8"	1/16"	50
1294	3/8"	7/16"	1-3/4"	1/16"	25
17094	3/8"	7/16"	1-3/4"	1/8"	25
3552	1/2"	17/32"	3/4"	3/64"	100
3554	1/2"	17/32"	1-1/4"	3/64"	100
3556	1/2"	17/32"	1-1/2"	3/64"	100
16023	1/2"	17/32"	2"	1/16"	25



Copper Washers

Auveco Part No.	Bolt Size	I.D.	O.D.	Thick-ness	Unit Pkg.
15911	3/16"	1/4"	7/16"	1/32"	50
15914	3/16"	1/4"	5/8"	1/16"	25
15912	1/4"	5/16"	1/2"	1/32"	50
15915	1/4"	5/16"	11/16"	1/16"	25
15913	5/16"	3/8"	9/16"	1/32"	50
15916	5/16"	3/8"	3/4"	1/16"	25
15917	3/8"	7/16"	13/16"	1/16"	25
15918	7/16"	1/2"	7/8"	1/16"	25
15919	1/2"	9/16"	13/16"	3/32"	25



Bowed Spring Washers Black Parkerized

Auveco Part No.	Bolt Size	I.D.	O.D.	Thick-ness	Unit Pkg.
9630	3/8"	25/64"	3/4"	1/64"	50

WASHERS

Vibration Proof Lock Washers

For Use With Grade 5, Grade 8 & ASTM 574 High Grade Bolts
Zinc Flake Coated



These washers have cams or wedges on one side, with a lead angle greater than a thread angle, and radial teeth or ribs on the other side. The washers are installed cam face to cam face. When tightening the fastener to preload, the teeth penetrate and seat against the joint material and the nut and/or fastener head. When subjected to vibration the interacting cams create a wedge action which prevents the fastener from vibrating loose.

Material: Carbon Steel
Hardness: Through Hardened: 465HVI

Auveco Part No.	Bolt Size	O.D.	Unit Pkg.
19282	3/16" (5mm)	11/32"	50 (25 pr.)
19283	1/4" (6mm)	27/64"	50 (25 pr.)
19284	5/16" (8mm)	17/32"	50 (25 pr.)
19285	3/8" (10mm)	21/32"	50 (25 pr.)
19286	7/16" (11mm)	23/32"	30 (15 pr.)
19287	1/2" (12mm)	49/64"	20 (10 pr.)
19288	9/16" (14mm)	29/32"	20 (10 pr.)
19289	5/8" (16mm)	1"	20 (10 pr.)
19290	3/4" (20mm)	1-7/32"	10 (5 pr.)
19291	1" (25mm)	1-17/32"	10 (5 pr.)

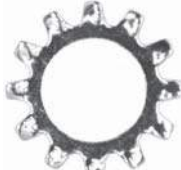

External Lock Washers

Zinc

Auveco Part No.	Bolt Size	O.D.	Unit Pkg.
5249	#4 (3/32")	1/4"	100
5250	#6 (1/8")	5/16"	100
5251	#8 (5/32")	3/8"	100
5252	#10 (3/16")	3/8"	100
5253	#12 (7/32")	15/32"	100
5254	#14 (1/4")	1/2"	100
5255	5/16"	19/32"	100
5256	3/8"	11/16"	100
5257	7/16"	3/4"	100
5258	1/2"	7/8"	100
16676	5/8"	1-1/32"	50
16677	3/4"	1-3/16"	50



Internal Lock Washers

Zinc

Auveco Part No.	Bolt Size	O.D.	Unit Pkg.
5259	#4 (3/32")	1/4"	100
5260	#6 (1/8")	9/32"	100
5261	#8 (5/32")	5/16"	100
5262	#10 (3/16")	3/8"	100
5263	#12 (7/32")	13/32"	100
5264	#14 (1/4")	15/32"	100
5265	5/16"	19/32"	100
5266	3/8"	11/16"	100
5267	7/16"	25/32"	100
5268	1/2"	7/8"	100
16672	5/8"	1-1/16"	100
16673	3/4"	1-7/32"	50
16675	1"	1-19/32"	10



Countersunk External Lock Washers

Zinc

Auveco Part No.	Bolt Size	O.D.	Unit Pkg.
5270	#6 (1/8")	9/32"	100
5271	#8 (5/32")	5/16"	100
5272	#10 (3/16")	11/32"	100
5274	#14 (1/4")	7/16"	100

**Please Order
In Unit Package
Quantities
Not Number Of Pieces**



**Internal-External
Combination Lock Washers
Zinc**

Auveco Part No.	Bolt Size	O.D.	Unit Pkg.
17017	#6 (1/8")	1/2"	100
17018	#8 (5/32")	1/2"	100
17019	#10 (3/16")	9/16"	100
17020	#14 (1/4")	23/32"	100
17021	5/16"	7/8"	100
17022	3/8"	31/32"	100
17023	7/16"	1-1/32"	50
17024	1/2"	1-7/32"	50

Natural Nylon Flat Washers



Auveco Part No.	Bolt Size	I.D. ± .015	O.D. ± .015	Thick. ± .010	Unit Pkg.
13888	1/16"	.115"	.250"	.032"	100
13891	1/16"	.140"	.312"	.062"	100
13892	1/8"	.171"	.375"	.032"	100
13893	1/8"	.171"	.375"	.062"	100
13894	1/8"	.194"	.375"	.032"	100
13895	1/8"	.194"	.375"	.062"	100
13896	3/16"	.242"	.375"	.062"	100
13897	1/8"	.200"	.437"	.062"	100
13898	3/16"	.257"	.500"	.062"	100
13899	1/4"	.281"	.500"	.030"	100
13900	1/4"	.317"	.500"	.062"	100
13902	3/16"	.260"	.562"	.062"	100
13903	1/8"	.187"	.625"	.062"	50
13904	5/16"	.380"	.625"	.062"	50
13905	3/16"	.260"	.687"	.060"	50
13906	3/8"	.421"	.687"	.062"	50
13907	1/2"	.568"	.687"	.062"	50
13908	1/4"	.317"	.750"	.062"	50
13909	5/16"	.390"	.750"	.062"	50
13910	3/8"	.443"	.750"	.062"	50
13911	7/16"	.505"	.750"	.062"	50
13912	3/16"	.257"	.875"	.062"	50
13913	5/16"	.343"	.885"	.062"	50
13914	3/8"	.406"	1.000"	.062"	25
13916	7/16"	.516"	1.250"	.062"	25
13918	5/16"	.390"	1.260"	.062"	25
13919	7/16"	.500"	1.375"	.062"	25
13920	7/16"	.525"	1.375"	.125"	25
13921	5/8"	.665"	1.500"	.094"	25

**X-Washers
Zinc**

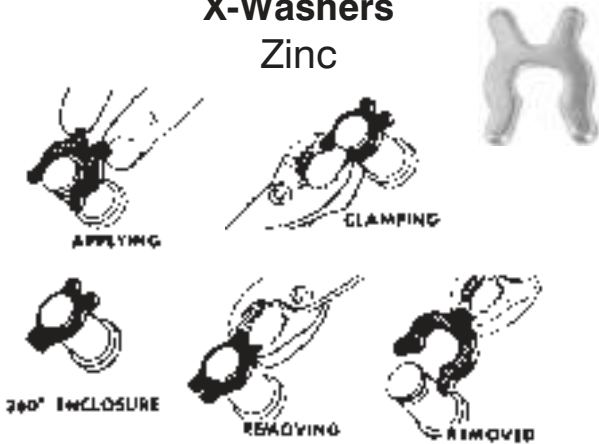

Auveco Part No.	Material Thickness	C	D	E	F	Unit Pkg.	
13691	.086	.025	.320	.406	.210	.406	50
13692	.098	.055	.364	.490	.297	.475	50
13693	.130	.055	.438	.576	.338	.558	50
13694	.164	.065	.523	.687	.422	.665	50
13695	.190	.065	.593	.745	.437	.730	25
13696	.222	.075	.622	.776	.469	.775	25
13697	.256	.075	.698	.905	.500	.890	25
13698	.285	.075	.822	.986	.563	.984	25
13699	.317	.089	.872	1.100	.609	1.078	25
13701	.381	.089	1.060	1.297	.797	1.281	10

Actual Size



13701

13699

13698

Commercial Tolerances All X-Washers

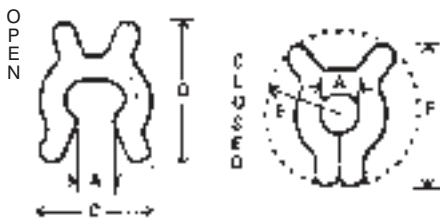

13691

13692

13693

13694

13695

13696

13697

SHIMS
(ILLUSTRATIONS ACTUAL SIZE)



1-1/4" x 1-1/8" w/ 3/8" Slot
Zinc

3155 1/16" Thick UNIT PKG: 100	3156 1/8" Thick UNIT PKG: 100
---	--

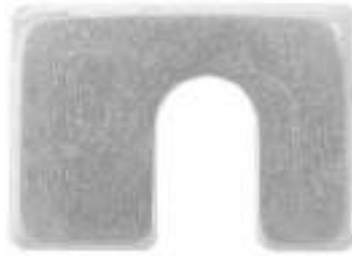

1-3/4" x 1-1/4" w/ 1/2" Slot
Zinc

2452 1/16" Thick UNIT PKG: 50	2453 1/8" Thick UNIT PKG: 50
--	---



1-3/4" x 1-1/4" w/ 1/2" Slot
Zinc

8445
1/8" Thick (10 Gauge Steel)
UNIT PACKAGE: 50



2" x 1-1/2" w/ 3/4" Slot
Zinc

3000
1/8" Thick
UNIT PKG: 50



2" x 1-1/2" w/ 5/8" Slot
Zinc

2999
1/8" Thick
UNIT PKG: 50

Universal Alignment Shims



1-3/16" x 1-15/32"

5/8" Slot
Zinc

Auveco Part No.	Thickness	Unit Pkg.
11187	1/32"	25



1-3/8" x 1-1/4" w/ 5/8" Slot
Zinc

20322
1/8" Thick
UNIT PKG: 50



15/16" O.D. w/ 3/8" Slot
Zinc

20448 1/16" Thick UNIT PKG: 50	20449 1/8" Thick UNIT PKG: 50
---	--

For an assortment of Body and Fender Shims see Fix-Kit No. 6166 in the green pages.

CASTER AND CAMBER SHIMS

(ILLUSTRATIONS ACTUAL SIZE)



**Caster and Camber and Ball Joints
Ford**

1-1/8" x 1-1/8"
1/2" Slot
Zinc



**Caster and Camber Shims
Chevrolet and GMC Trucks**

1-1/2" x 2-1/2"
9/16" Slot
Zinc

Auveco Part No.	Thickness	Unit Pkg.	Auveco Part No.	Thickness	Unit Pkg.
5074.....	1/64"	50	5096.....	1/32"	50
5075.....	1/32"	50	5097.....	1/16"	50
5076.....	1/16"	50			
5077.....	1/8"	50			

HELPFUL HINTS.....

FOR USING THE Auveco Catalog

- The color-coded pages signify various sections:
Blue-Metric Items
Beige-Electrical Accessories
Green-Assortments, Cabinets, Bins & Racks
Gray-Key Blanks & Accessories
Pink-Import Car Body Hardware
- Most pictures are actual size. You should be able to set a part on top of the picture to positively identify it.
- Our Display Boards, which are shown on the four color pages in the front of the catalog, are a great aid in identifying product.
- We have three different indexes in the front of the catalog to assist you.
Pictorial Quick Index
Alphabetical Index
Numerical Index
- Specification charts listing the pertinent dimensions, plating and color information are included for:
Body Bolts: pages 20 and 49-50
Special Tapping Screws: pages 23-36 and 54-57
License Plate Screws: pages 33-34
"Xmas Tree" Retainers: pages 404-413
Push-Type Retainers: pages 450-460
- There are two OEM Part Number To Auveco Part Number Cross References at the back of the catalog.

METRIC RETAINING RINGS

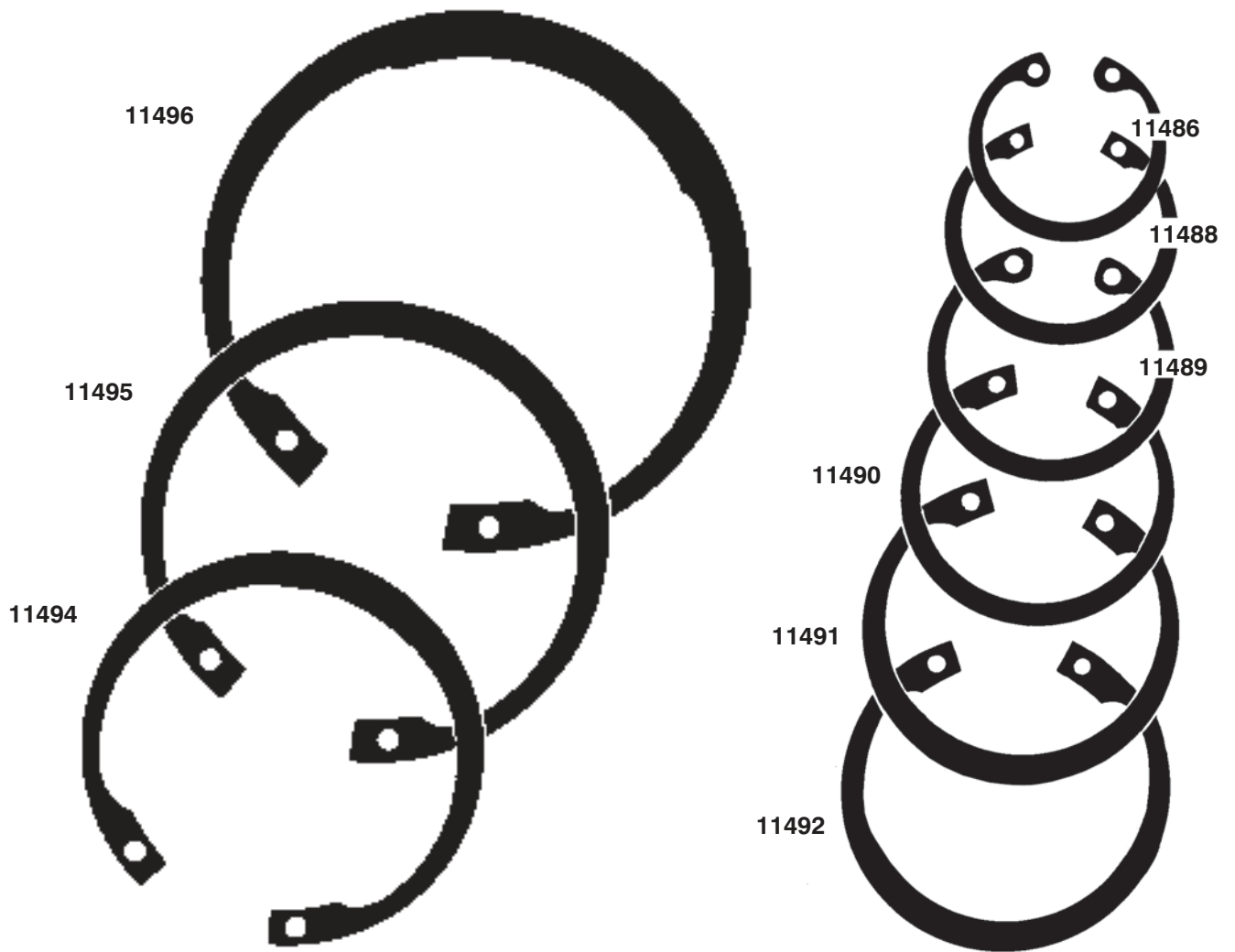

**Metric
Basic Internal
Retaining Rings**
DIN 472 - 1300
Groove Required In Bore
Phosphate & Oil Finish

Auveco Part No.	Shaft Diameter		Groove Diameter		Groove Width		Unit Pkg.
	mm	Inches	mm	Inches	mm	Inches	
11486	26	1.024	27.2	1.072	1.30	.051	50
11488	30	1.181	31.4	1.237	1.30	.051	50
11489	32	1.260	33.7	1.328	1.30	.051	50
11490	35	1.378	37.0	1.457	1.60	.063	50
11491	40	1.575	42.5	1.675	1.85	.073	25
11492	42	1.654	44.5	1.753	1.85	.073	25
11494	52	2.047	55.0	2.165	2.15	.085	25
11495	62	2.441	65.0	2.559	2.15	.085	10
11496	72	2.835	75.0	2.953	2.65	.104	10

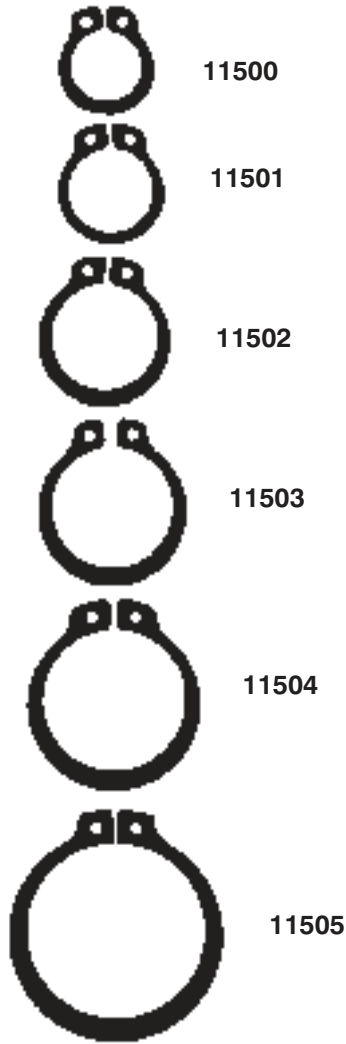

11506



11507



**Metric
Basic External
Retaining Rings**
DIN 471 - 1400
Groove Required On Shaft
Phosphate & Oil Finish

Auveco Part No.	Shaft Diameter		Groove Diameter		Groove Width		Unit Pkg.
	mm	Inches	mm	Inches	mm	Inches	
11500	10.0	.394	9.6	.378	1.10	.043	100
11501	12.0	.472	11.5	.452	1.10	.043	100
11502	15.0	.591	14.3	.563	1.10	.043	100
11503	17.0	.670	16.2	.637	1.10	.043	50
11504	20.0	.787	19.0	.748	1.30	.051	50
11505	25.0	.985	23.9	.941	1.30	.051	50
11506	30.0	1.182	28.6	1.126	1.60	.063	50
11507	35.0	1.378	33.0	1.299	1.60	.063	50

METRIC RETAINING RINGS

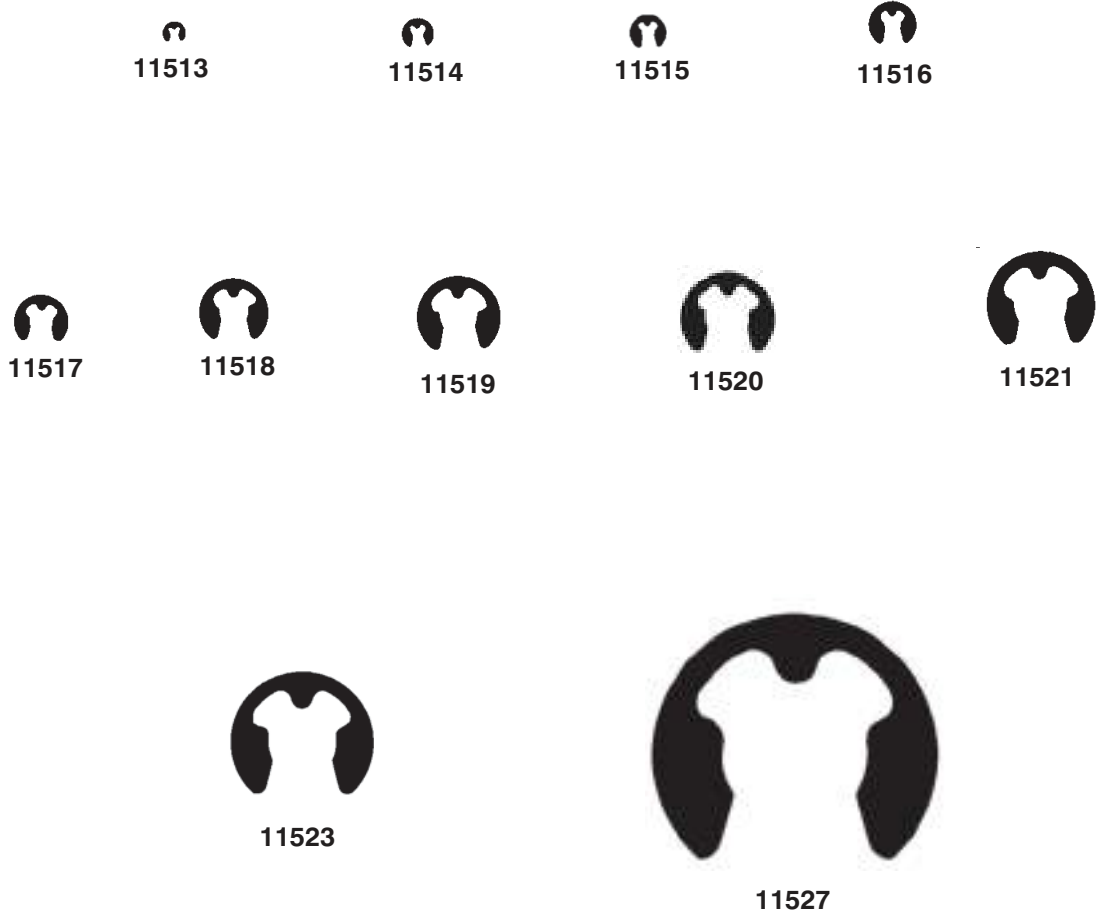

“E” Type Retaining Rings

DIN 6799 - 1500
Phosphate & Oil Finish

Auveco Part No.	Shaft Diameter		Groove Diameter		Groove Width		Unit Pkg.
	mm	Inches	mm	Inches	mm	Inches	
11513	1.4	.055	1.2	.047	0.34	.0134	100
11514	2.0	.079	1.5	.059	0.44	.0173	100
11515	2.5	.098	1.9	.075	0.54	.0213	100
11516	3.0	.118	2.3	.091	0.64	.0252	100
11517	4.0	.157	3.2	.126	0.64	.0252	100
11518	5.0	.197	4.0	.157	0.74	.0291	100
11519	6.0	.236	5.0	.197	0.74	.0291	100
11520	7.0	.276	6.0	.236	0.74	.0291	100
11521	8.0	.315	7.0	.276	0.94	.0370	100
11523	10.0	.394	9.0	.354	1.15	.0453	100
11527	20.0	.787	19.0	.748	1.85	.0728	50

RETAINING RINGS

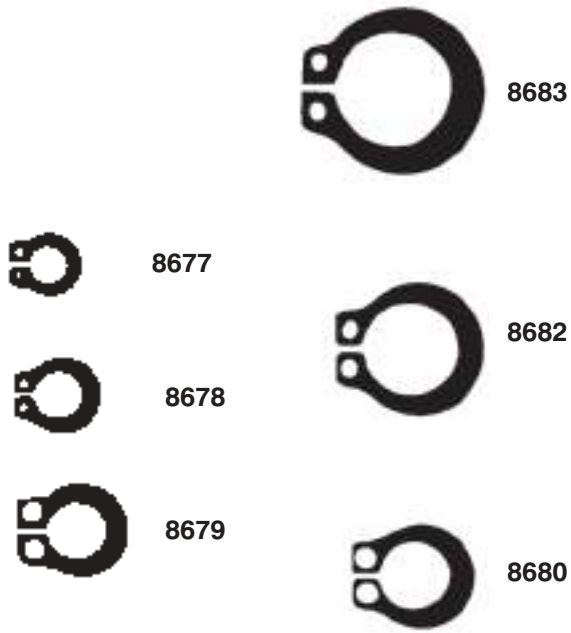
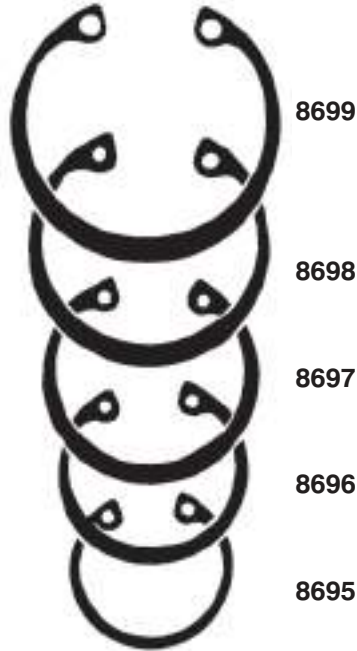
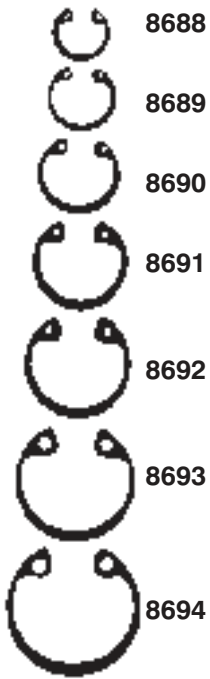

Basic Internal Retaining Rings

Groove Required On Shaft
Bright Zinc

Auveco Part No.	Housing Dia.	Groove Dia.	Groove Width	Unit Pkg.
8688	1/4"	.268"	.020"	50
8689	5/16"	.330"	.020"	50
8690	3/8"	.397"	.029"	50
8691	7/16"	.461"	.029"	50
8692	1/2"	.530"	.039"	50
8693	9/16"	.596"	.039"	50
8694	5/8"	.665"	.039"	50
8695	3/4"	.796"	.039"	50
8696	7/8"	.931"	.046"	50
8697	1"	1.066"	.046"	50
8698	1-1/8"	1.197"	.056"	50
8699	1-1/4"	1.330"	.056"	50

External Grip Rings

No Groove Required
Bright Zinc

Auveco Part No.	Shaft Diameter	Unit Pkg.
8677	3/16" - (.185 to .189 Shaft)	50
8678	1/4" - (.248 to .252 Shaft)	50
8679	5/16" - (.310 to .316 Shaft)	50
8680	3/8" - (.373 to .379 Shaft)	50
8682	1/2" - (.497 to .503 Shaft)	50
8683	5/8" - (.622 to .628 Shaft)	50

Internal Self-Locking Retaining Rings



No Groove Required
Bright Zinc

Auveco Part No.	Shaft Diameter	Unit Pkg.
8715	3/16" - (.184 to .192 Shaft)	100

BASIC EXTERNAL RETAINING RINGS

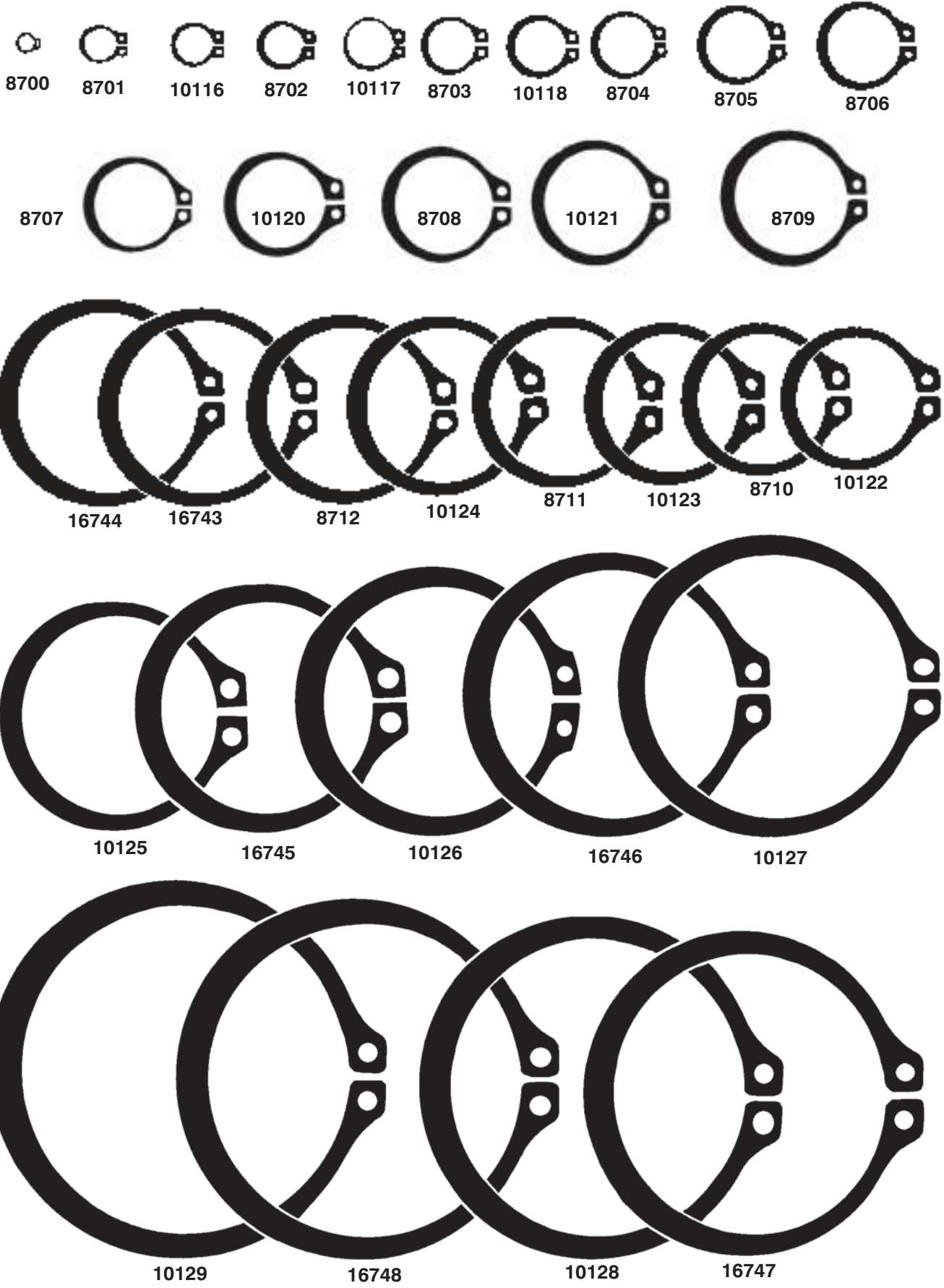

Sec. 10



RETAINING RINGS
Basic External Retaining Rings

Groove Required On Shaft
Bright Zinc

Actual Size Illustrations On Previous Page

Auveco Part No.	Shaft Diameter	Groove Diameter	Groove Width	Unit Pkg.	Auveco Part No.	Shaft Diameter	Groove Diameter	Groove Width	Unit Pkg.
8700	1/8"	.117"	.012"	50	8710	1"	.940"	.046"	50
8701	1/4"	.230"	.029"	50	10123	1-1/16"	.998"	.056"	50
10116	9/32"	.261"	.029"	50	8711	1-1/8"	1.059"	.056"	50
8702	5/16"	.290"	.029"	50	10124	1-3/16"	1.118"	.056"	50
10117	11/32"	.321"	.029"	50	8712	1-1/4"	1.176"	.056"	50
8703	3/8"	.352"	.029"	50	16743	1-5/16"	1.232"	.056"	50
10118	13/32"	.382"	.029"	50	16744	1-3/8"	1.291"	.056"	50
8704	7/16"	.412"	.029"	50	10125	1-1/2"	1.406"	.056"	25
8705	1/2"	.468"	.039"	50	16745	1-5/8"	1.529"	.068"	25
8706	9/16"	.530"	.039"	50	10126	1-3/4"	1.650"	.068"	25
8707	5/8"	.588"	.039"	50	16746	1-7/8"	1.769"	.068"	25
10120	11/16"	.646"	.046"	50	10127	.2"	1.886"	.068"	10
8708	3/4"	.704"	.046"	50	16747	2-1/8"	2.003"	.086"	10
10121	13/16"	.762"	.046"	50	10128	2-1/4"	2.120"	.086"	10
8709	7/8"	.821"	.046"	50	16748	2-3/8"	2.239"	.086"	10
10122	15/16"	.882"	.046"	50	10129	2-1/2"	2.360"	.086"	10

For an assortment of Basic Internal and External Retaining Rings see Kit No. 6116 and Large Drawer Assortment No. 6507

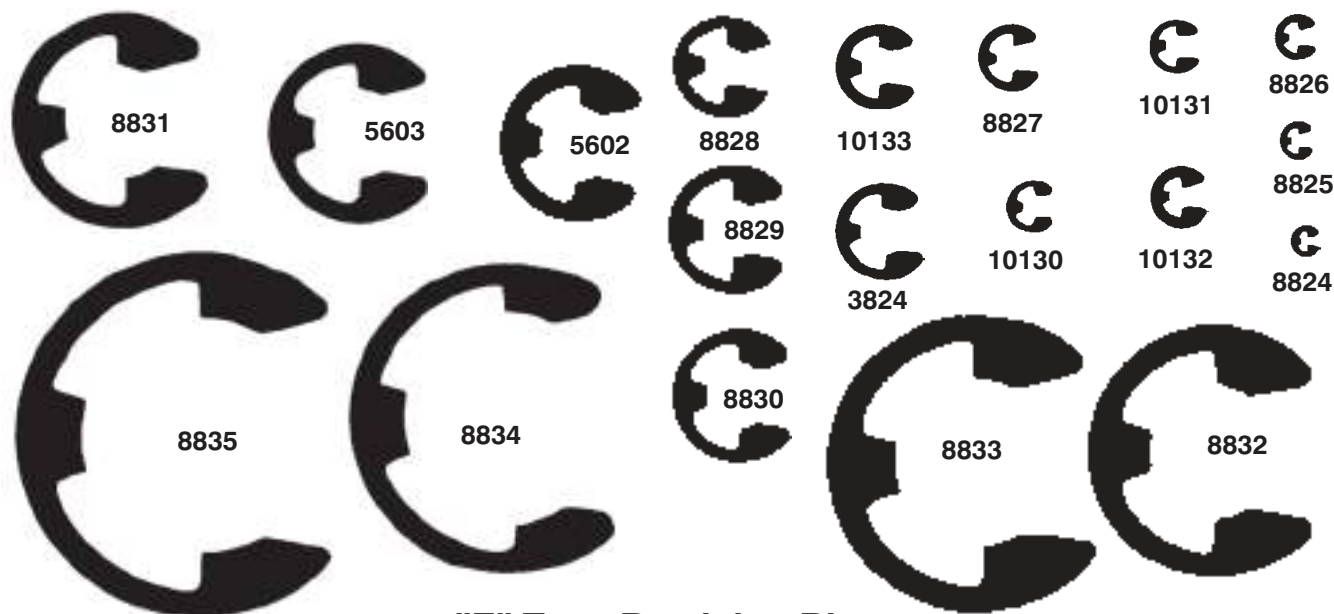

"E" Type Retaining Rings

Phosphate & Oil

Auveco Part No.	Shaft Dia.	Groove Dia.	Groove Width	Unit Pkg.	Auveco Part No.	Shaft Dia.	Groove Dia.	Groove Width	Unit Pkg.
8824	1/16"	.052"	.012"	100	8829	3/8"	.303"	.039"	100
8825	3/32"	.074"	.018"	100	8830	7/16"	.343"	.039"	100
8826	1/8"	.095"	.018"	100	5602	1/2"	.396"	.046"	100
10130	9/64"	.105"	.018"	100	5603	5/8"	.485"	.046"	100
10131	5/32"	.116"	.029"	100	8831	3/4"	.580"	.056"	50
10132	11/64"	.127"	.029"	100	8832	7/8"	.675"	.056"	50
8827	3/16"	.147"	.029"	100	8833	.1"	.835"	.056"	50
10133	7/32"	.188"	.029"	100	8834	1-3/16"	1.079"	.068"	50
8828	1/4"	.210"	.029"	100	8835	1-3/8"	1.230"	.068"	50
3824	5/16"	.250"	.029"	100					

For an assortment of E and Reinforced E Type Retaining Rings see Kit No. 6086, 6123 and Large Drawer 6508.



Reinforced "E" Type Retaining Rings

Auveco Part No.	Shaft Dia.	Groove Dia.	Groove Width	Unit Pkg.	Auveco Part No.	Shaft Dia.	Groove Dia.	Groove Width	Unit Pkg.
8836	3/32"	.074"	.018"	100	3628	5/16"	.250"	.039"	100
3165	1/8"	.095"	.018"	100	5600	3/8"	.303"	.039"	100
10134	5/32"	.116"	.029"	100	2672	7/16"	.343"	.039"	100
3166	3/16"	.147"	.029"	100	8837	1/2"	.396"	.046"	100
10135	7/32"	.188"	.029"	100	5601	9/16"	.437"	.046"	100
3167	1/4"	.210"	.029"	100					

For an Assortment of "E" and Reinforced E Type Retaining Rings see Kit No. 6086, 6123 and Large Drawer 6508

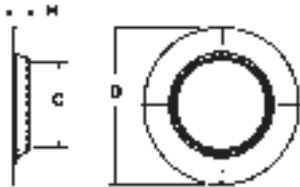

Grooveless Retainer Ring 300 Series Stainless Steel

Auveco Part No.	Unit Pkg.	Stud Size	Outside Dia. (C)	Height (D)	Material Thickness (H)
14113	25	.375"	.625"	.030"	.010"

These Grooveless Retainer Rings press over studs, shafts or any round shape with a .375" diameter. They become an integral part of the axial application replacing snap or bearing rings and cotter pins. Designed without slots or shears, these rings will not "walk-off" or spring free.

Convertible Retaining Ring Pliers

For Internal and External Retaining Rings

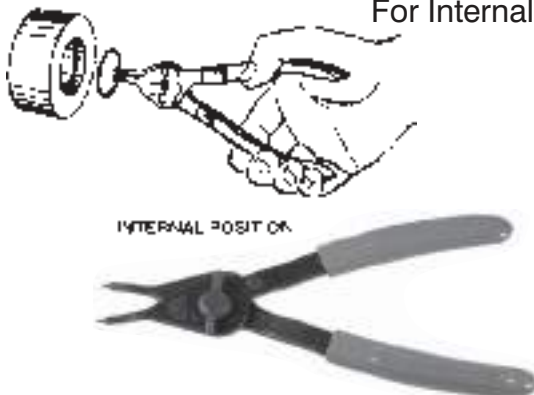

7909

Tip Diameter: .042"
Use with Auveco Retaining Rings:
8677 to 8678 (External)
8688 to 8697 (Internal)
8700 to 8709 (External)
10116 to 10121 (External)

UNIT PACKAGE: 1



7910

Tip Diameter: .070"
Use With Auveco Retaining Rings:
8679 to 8633 (External)
8698 & 8699 (Internal)
8710 to 8712 (External)
10122 to 10129 (External)
16743 to 16748 (External)

UNIT PACKAGE: 1

SPRINGS

Extension Springs

Zinc

Auveco Part No.	Unit Pkg.	Type	Length Overall	Coil Length	O.D.	Wire Size	Lbs Rate/ Inch	Approx. Lbs Load @ Reference Ext.
14058	5	3	10"	9.250"	.500"	.062"	1.8	10.2 @ 12"
14059	5	2	6.438"	5.575"	.438"	.048"	1.1	4.2 @ 8.437"
14060	5	1	6.500"	5.925"	.328"	.035"	7.5 oz.	2.2 @ 8.500"
14063	5	4	3.250"	2.750"	.375"	.041"	1.9	5.2 @ 5.250"
14064	5	1	4.00"	3.450"	.250"	.028"	13 oz.	1.9 @ 6.00"
14065	5	3	4.500"	3.575"	.484"	.063"	6.2	14 @ 6.500"
14066*	5	1	4.062"	2.750"	.734"	.062"	1.4	4.3 @ 6.062"
14067	5	3	4.00"	2.825"	.719"	.105"	12.5	36.5 @ 5.00"
14068	10	6	5.250"	3.000"	.531"	.062"	5.0	8.5 @ 6.250"
14070	5	5	2.656"	1.500"	.750"	.080"	10.3	12.5 @ 3.656"
14072	10	3	1.438"	.825"	.344"	.048"	15.0	10 @ 1.812"
14074	10	1	1.125"	.700"	.234"	.020"	12.0	9 oz. @ 1.625"

* Not Zinc Plated



Type 1



Type 2
(Double Loop On Both Ends)

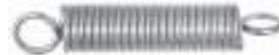

Type 3



Type 4



Type 5



Type 6

Universal Springs

Galvanized



14097



14099



14100



14098



14101



14102



14103



14104



Auveco Part No.	Unit Pkg.	Length Overall	Coil Length	O.D.	Wire Size
14097	10	11-1/2"	1-7/8"	13/32"	1/32"
14098	10	4-3/8"	2-1/2"	1/2"	1/16"
14099	10	1-13/16"	1-1/2"	3/8"	1/32"
14100	10	8-1/2"	1-7/8"	3/4"	3/32"
14101	10	5-3/4"	2-3/8"	25/32"	3/64"
14102	10	18-1/2"	2"	13/16"	3/32"
14103	10	17-1/2"	3-1/2"	3/4"	1/16"
14104	10	8-1/4"	2"	7/16"	1/16"



Compression Springs Zinc

Auveco Part No.	Unit Qty.	Length Overall	O.D.	Wire Size	Approx. Solid Ht.	Lbs. Rate/ Inch
14089	20	2.193"	.590"	.040"	.380"	3.1
14094*	20	.781"	.375"	.042"	.378"	7.4
14095	10	2.625"	.438"	.048"	.950"	6.0
14096	10	2.500"	.500"	.063"	1.00"	18.0

* Brass

Throttle Rod Clips Black Phosphate					Retainer Pins Zinc				
									
Left-hand Type					Right-hand Type				
Auveco Part No.	Rod Diameter	Ind. Std.	Unit Pkg.	Auveco Part No.	Inside Diameter	Overall Length	Wire Dia.	Unit Pkg.	
3609	5/32"	2	Right	9114	1/16"	3/8"	.035"	100	
3610	5/32"	2	Left	9894	1/16"	19/32"	.045"	100	
3611	3/16"	4	Right	10390	7/64"	3/4"	.050"	100	
3612	3/16"	4	Left	9112	1/8"	1-1/8"	.070"	100	
3613	1/4"	7	Right	9111	5/32"	7/8"	.050"	100	
3614	1/4"	7	Left	9110	3/16"	1-3/16"	.070"	100	
For an assortment of Throttle Rod Clips see Kit No. 6086.									

Hair Pin Cotters



Auveco Part No.	Inside Diameter	Overall Length	Wire Diameter	Unit Pkg.	Auveco Part No.	Inside Diameter	Overall Length	Wire Diameter	Unit Pkg.
3168	1/16"	23/64"	.025"	200	2598	7/32"	3/4"	.060"	100
9890	3/32"	3/8"	.025"	100	9892	5/16"	1"	.060"	100
3176	5/32"	5/8"	.045"	200					

Sec. 10

HAIR PIN COTTERS
(ILLUSTRATIONS ACTUAL SIZE)
Zinc

Auveco Part No.	Wire Dia.	Drill Hole Size	Min. Shaft Dia.	Max. Shaft Dia.	Overall Length	Inside Dia. Of Eye	Unit Pkg.
16934.....	.042" (3/64")	3/64"	3/16"	1/4"	1"	1/4"	100
16727.....	.080" (5/64")	3/32"	1/4"	3/8"	1-3/16"	1/4"	100
11872.....	.080" (5/64")	3/32"	3/8"	1/2"	1-9/16"	5/16"	100
10391.....	.080" (5/64")	3/32"	3/8"	1/2"	1-9/16"	5/16"	100
11873.....	.062" (1/16")	5/64"	3/8"	1/2"	1-9/16"	5/16"	100
10392.....	.062" (1/16")	5/64"	3/8"	1/2"	1-9/16"	5/16"	100
10393.....	.125" (1/8")	9/64"	1/2"	3/4"	1-15/16"	7/16"	50
11874.....	.125" (1/8")	9/64"	1/2"	3/4"	1-15/16"	7/16"	50
10394.....	.093" (3/32")	7/64"	1/4"	5/8"	2-5/16"	5/8"	50
10395.....	.125" (1/8")	9/64"	5/8"	7/8"	2-1/2"	1/2"	25
10396.....	.177" (3/16")	3/16"	7/8"	1-1/4"	3-3/4"	7/8"	10
10398.....	.243" (1/4")	17/64"	3/4"	1"	4"	15/16"	10
10397.....	.310" (5/16")	21/64"	7/8"	1"	3-15/16"	7/8"	5



10394



16934



10395



16727

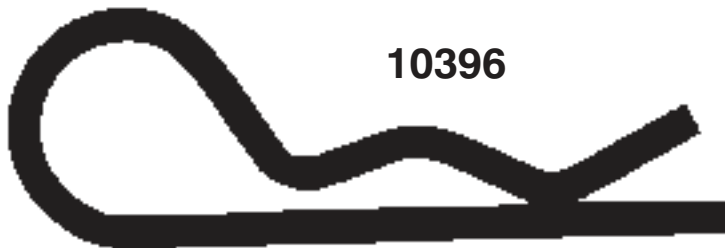

10396



11872



10398



10391



10397



11873



10392



10393



11874

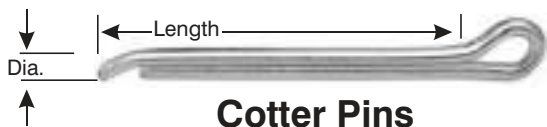

PINS

**Cotter Pins
Hammer-Lock Type
C 1008 Steel**

Auveco Part No. Plated	Auveco Part No. Plain	Size	Unit Pkg.
8477	3502	1/16" x 1/2"	200
8478	3503	1/16" x 3/4"	200
8479	3504	1/16" x 1"	200
14901	3505	1/16" x 1-1/4"	200
8480	3506	1/16" x 1-1/2"	200
14902	3508	1/16" x 2"	200
14903	3509	3/32" x 1/2"	200
8481		3/32" x 3/4"	200
8482	3511	3/32" x 1"	200
8483	3512	3/32" x 1-1/4"	200
8484	3513	3/32" x 1-1/2"	200
8485	3515	3/32" x 2"	200
14904	3519	1/8" x 3/4"	200
8486	3520	1/8" x 1"	200
8487	3521	1/8" x 1-1/4"	200
8488	3522	1/8" x 1-1/2"	200
8489		1/8" x 1-3/4"	200
8490	3524	1/8" x 2"	200
8491	3526	1/8" x 2-1/2"	200
8492		5/32" x 1"	100
14905	8506	5/32" x 1-1/4"	100
8493	8507	5/32" x 1-1/2"	100
14906	8508	5/32" x 1-3/4"	100
8494	8509	5/32" x 2"	100
14907	8511	5/32" x 2-1/2"	100
14908		5/32" x 3"	100
14909		3/16" x 1"	100
14910		3/16" x 1-1/4"	100
8495	8516	3/16" x 1-1/2"	100
8496	8518	3/16" x 2"	100
8497		3/16" x 2-1/2"	100
14911	8521	3/16" x 3"	100
8498		1/4" x 1-1/2"	100
8499		1/4" x 2"	100
8500		1/4" x 2-1/2"	100
8501	8530	1/4" x 3"	100
14912		1/4" x 4"	100
8502		5/16" x 2-1/2"	50
8503		5/16" x 3"	50

For assortments of Cotter Pins see Fix-Kit Assortment Nos. 6051, 6112 and Large Drawer (6500 Series) No. 6506



Lynch Pins

Auveco Part No.	Pin Size	Ring I.D.	Ring O.D.	Unit Pkg.
11733	7/16" O.D. x 2-1/2" Long Black Powder Coated	1-7/8"	2-1/4"	5
11736	1/4" O.D. x 2-1/8" Long Zinc Plated	1-5/8"	1-7/8"	10



**Clevis Pins
Drilled For Cotter Pins
Zinc**

Auveco Part No.	Dia.	Use Pin Dia.	Length Under Head to Ctr of Hole	Length Under Head to End of Pin
9433	1/4"	1/16"	.29/32"	1"
9435	5/16"	3/32"	.7/8"	1"
9436	5/16"	3/32"	1"	1-1/8"
9438	5/16"	3/32"	1-1/4"	1-3/8"
9440	3/8"	3/32"	.7/8"	1"
9441	3/8"	3/32"	1"	1-1/8"
9443	3/8"	3/32"	1-1/8"	1-1/4"
9444	3/8"	3/32"	1-3/8"	1-1/2"
9446	1/2"	1/8"	1-11/32"	1-1/2"
9447	1/2"	1/8"	1-19/32"	1-3/4"

UNIT PACKAGE: 25

**Universal Clevis Pins
Zinc**



Auveco Part No.	Size	Use Cotter Pin Dia.	No. of Holes	Unit Pkg.
3703	1/4" x 2"	3/32"	6	10
3704	5/16" x 2"	3/32"	6	10
3705	3/8" x 2"	3/32"	6	10
3708	7/16" x 2-1/2"	3/32"	7	10
3707	1/2" x 2"	1/8"	6	10
3709	1/2" x 2-1/2"	1/8"	7	10
8265	1/2" x 3"	1/8"	7	10

For an assortment of Universal Clevis Pins see Fix-Kit No. 6060 in the green pages.

Sec. 10

YOKE ENDS & SPRING PINS

Yoke Ends

Drop Forged • Adjustable • Zinc Finish

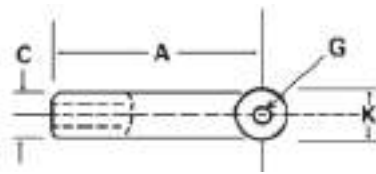
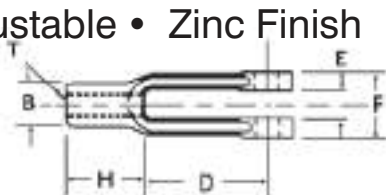

Auveco Part No.	"T" Tap Size	A	B	C	D	E	F	G	H	K	Unit Pkg.
10737	1/4"-28	2"	7/16"	7/16"	1-1/4"	9/32"	5/8"	1/4"	3/4"	1/2"	10
10788	1/4"-28	2"	7/16"	7/16"	1-1/4"	9/32"	5/8"	1/4"	3/4"	1/2"	2
10738	5/16"-24	2-1/4"	1/2"	1/2"	1-7/16"	11/32"	3/4"	5/16"	13/16"	19/32"	10
10789	5/16"-24	2-1/4"	1/2"	1/2"	1-7/16"	11/32"	3/4"	5/16"	13/16"	19/32"	2
10739	3/8"-24	2-1/2"	5/8"	5/8"	1-5/8"	7/16"	7/8"	3/8"	7/8"	11/16"	10
10790	3/8"-24	2-1/2"	5/8"	5/8"	1-5/8"	7/16"	7/8"	3/8"	7/8"	11/16"	2
10740	7/16"-20	2-7/8"	23/32"	23/32"	1-7/8"	1/2"	1"	7/16"	1"	13/16"	10
10791	7/16"-20	2-7/8"	23/32"	23/32"	1-7/8"	1/2"	1"	7/16"	1"	13/16"	2
10741	1/2"-20	3"	13/16"	13/16"	1-7/8"	9/16"	1-1/8"	1/2"	1-1/8"	15/16"	10
10792	1/2"-20	3"	13/16"	13/16"	1-7/8"	9/16"	1-1/8"	1/2"	1-1/8"	15/16"	2
10742	5/8"-18	4-15/16"	1-1/16"	1-1/16"	3-11/16"	11/16"	1-3/8"	5/8"	1-1/4"	1-3/16"	10
10793	5/8"-18	4-15/16"	1-1/16"	1-1/16"	3-11/16"	11/16"	1-3/8"	5/8"	1-1/4"	1-3/16"	2

Spring Pins Zinc

Auveco Part No.	Dia.	Length	Wall Thick.	Unit Pkg.	Auveco Part No.	Dia.	Length	Wall Thick.	Unit Pkg.
8981	1/16"	3/16"	.012"	50	9019	3/16"	1/2"	.040"	50
8983	1/16"	1/2"	.012"	50	9021	3/16"	3/4"	.040"	50
8985	1/16"	3/4"	.012"	50	9022	3/16"	1"	.040"	50
8987	1/16"	1"	.012"	50	9023	3/16"	1-1/4"	.040"	50
8988	5/64"	1/4"	.018"	50	9024	3/16"	1-1/2"	.040"	50
8989	5/64"	1/2"	.018"	50	9025	3/16"	1-3/4"	.040"	50
8991	5/64"	3/4"	.018"	50	9026	3/16"	2"	.040"	50
8992	5/64"	1"	.018"	50	9027	7/32"	5/8"	.048"	50
8993	5/64"	1-1/4"	.018"	50	9028	7/32"	1-3/8"	.048"	50
8994	5/64"	1-1/2"	.018"	50	9029	7/32"	1-3/4"	.048"	50
8995	3/32"	5/16"	.022"	50	9030	1/4"	5/8"	.050"	50
8996	3/32"	1/2"	.022"	50	9031	1/4"	3/4"	.050"	50
8997	3/32"	5/8"	.022"	50	9033	1/4"	1"	.050"	50
8998	3/32"	3/4"	.022"	50	9034	1/4"	1-1/4"	.050"	50
8999	3/32"	7/8"	.022"	50	9035	1/4"	1-1/2"	.050"	50
9000	3/32"	1"	.022"	50	9036	1/4"	1-3/4"	.050"	50
9001	3/32"	1-1/4"	.022"	50	9037	1/4"	2"	.050"	50
9002	3/32"	1-1/2"	.022"	50	9038	1/4"	2-1/4"	.050"	50
9003	1/8"	3/8"	.028"	50	9039	1/4"	2-1/2"	.050"	50
9004	1/8"	1/2"	.028"	50	9040	5/16"	3/4"	.062"	50
9005	1/8"	5/8"	.028"	50	9042	5/16"	1"	.062"	50
9006	1/8"	3/4"	.028"	50	9043	5/16"	1-1/2"	.062"	50
9007	1/8"	7/8"	.028"	50	9044	5/16"	1-3/4"	.062"	25
9008	1/8"	1"	.028"	50	9045	5/16"	2"	.062"	25
9009	1/8"	1-1/4"	.028"	50	9046	5/16"	2-1/2"	.062"	25
9010	1/8"	1-1/2"	.028"	50	9048	3/8"	1"	.077"	25
9011	1/8"	1-3/4"	.028"	50	9049	3/8"	1-1/2"	.077"	25
9012	1/8"	2"	.028"	50	9050	3/8"	2"	.077"	25
9013	5/32"	1/2"	.032"	50	9051	3/8"	2-1/2"	.077"	25
9015	5/32"	3/4"	.032"	50					
9016	5/32"	1"	.032"	50					
9017	5/32"	1-1/4"	.032"	50					
9018	5/32"	1-1/2"	.032"	50					

For Spring Pin Assortments see Kits 6124, 6125 and Large Drawer (6500 Series) Assortment No. 6509 and 6510.

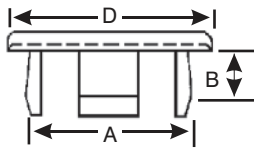

PLUG BUTTONS

Nylon 6/6 Matte Finish



Auveco Part No.	Hole Size (A)	Panel Thickness (B)	Head Size (D)	Head Height	Color	Unit Pkg.
13862	3/16"	1/32"-9/64"	11/32"	.040"	Natural	100
13863	3/16"	1/32"-9/64"	11/32"	.040"	Black	100
13864	1/4"	1/32"-1/16"	27/64"	.040"	Natural	100
13865	1/4"	1/32"-1/16"	27/64"	.040"	Black	100
13866	5/16"	1/32"-9/64"	29/64"	.050"	Natural	100
13867	5/16"	1/32"-9/64"	29/64"	.050"	Black	100
13868	3/8"	1/32"-9/64"	37/64"	.050"	Natural	100
13869	3/8"	1/32"-9/64"	37/64"	.050"	Black	100
13871	7/16"	1/32"-11/64"	39/64"	.050"	Black	50
13872	1/2"	1/32"-9/64"	43/64"	.062"	Natural	50
13873	1/2"	1/32"-9/64"	43/64"	.062"	Black	50
13875	9/16"	1/32"-9/64"	47/64"	.062"	Black	50
13876	5/8"	1/32"-5/64"	51/64"	.062"	Natural	50
13877	5/8"	1/32"-5/64"	51/64"	.062"	Black	50
13879	11/16"	1/32"-7/64"	57/64"	.062"	Black	50
13880	3/4"	1/32"-7/64"	63/64"	.062"	Natural	50
13881	3/4"	1/32"-7/64"	63/64"	.062"	Black	50
13883	13/16"	1/32"-7/64"	1-1/32"	.062"	Black	50
13885	7/8"	1/32"-7/64"	1-5/64"	.062"	Black	50
13887	1"	1/32"-7/64"	1-7/32"	.062"	Black	50



Plastic Plug Buttons

Black Polyethylene
Depressed Center

Auveco Part No.	Hole Size	Head Dia.	Working Thickness	Unit Pkg.
9288	1/2"	7/8"	.02 - .07"	100
9289	3/4"	1-5/32"	.02 - .14"	100
9290	7/8"	1-1/4"	.02 - .10"	100
9291	1"	1-3/8"	.04 - .10"	100
9292	1-1/4"	1-5/8"	.04 - .10"	100
9293	1-1/2"	1-7/8"	.04 - .10"	100
17207	1-3/4"	2-1/8"	.15 - .17"	50
17208	2"	2-3/8"	.17 - .19"	50
18798	2-1/2"	3"	.15 - .17"	25
18799	3"	3-1/2"	.18 - .20"	10



Flush Sheet Metal Plugs

Black Polyethylene

Fits 14 to 26 Gauge Material

Auveco Part No.	Hole Size	Head Dia.	Unit Pkg.
14923	3/8"	3/4"	100
11746	1/2"	7/8"	100
18750	5/8"	1-3/64"	100
11747	3/4"	1"	100
11748	7/8"	1-5/32"	100
11749	1"	1-7/16"	100
18800	1-1/4"	1-5/8"	50
18801	1-1/2"	1-7/8"	25
18802	1-3/4"	2-1/8"	25
18803	2"	2-7/16"	10
18804	2-1/2"	3"	10
18806	3"	3-3/8"	5



Plug Buttons

Nickel Plated

Auveco Part No.	Hole Size	Head Dia.	Working Thickness	Unit Pkg.
3750	1/4"	13/32"	.035" - .062"	50
3751	3/8"	1/2"	.037" - .078"	50
3752	1/2"	21/32"	.037" - .062"	50
3753	5/8"	13/16"	.062" - .078"	50
3754	3/4"	15/16"	.037" - .093"	50
3755	7/8"	1-1/16"	.031" - .093"	50
3756	1"	1-1/8"	.062" - .093"	50
10231	1-1/4"	1-7/16"	.062" - .093"	10
10232	1-1/2"	1-21/32"	.038" - .141"	10

**Display Boards Are Great
Selling Tools. Use Them To
Help Boost Your Sales.
Refer To The Color Pages
At The Front Of The Catalog.**

Sec. 10

Black Nylon Locking Hole Plugs



These hole plugs are designed with multiple locks to positively snap into panel thicknesses ranging from 1/64" to 1/8". Excellent for paintless dent repair. Made of heat stabilized nylon and suitable for elevated temperatures.

Auveco Part No.	Panel Hole Diameter	Maximum Panel Thickness	Plug Dimensions		Unit Pkg
			Head Diameter	Thickness	
19764	3/16"	1/16"	1/4"	15/64"	100
18900	1/4"	1/16"	5/16"	5/16"	50
19765	5/16"	1/16"	3/8"	5/16"	50
18901	3/8"	1/8"	15/32"	13/32"	50
19766	7/16"	1/8"	17/32"	13/32"	50
18902	1/2"	1/8"	37/64"	13/32"	50
19767	9/16"	1/8"	21/32"	13/32"	50
18903	5/8"	1/8"	23/32"	13/32"	50
18904	3/4"	1/8"	59/64"	13/32"	50
19769	13/16"	1/8"	57/64"	13/32"	50
18905	7/8"	1/8"	1-1/64"	29/64"	50
18906	1"	1/8"	1-13/64"	29/64"	50
19770	1-1/32"	1/8"	1-7/32"	29/64"	50
19771	1-3/16"	1/8"	1-5/16"	29/64"	50
18907	1-1/4"	1/8"	1-3/8"	29/64"	50
19772	1-3/8"	1/8"	1-1/2"	29/64"	25
18908	1-1/2"	1/8"	1-43/64"	29/64"	25
18909	1-3/4"	1/8"	1-29/32"	29/64"	25
18910	2"	1/8"	2-9/64"	29/64"	25



Straight Keys

Plain

Auveco Part No.	Size	Unit Pkg.
-----------------	------	-----------

Short Lengths

9759	1/4" x 1/4" x 2-1/2"	10
9774	5/16" x 5/16" x 4"	10

Long Lengths

9794	3/16" x 3/16" x 12"	5
9795	1/4" x 1/4" x 12"	5
9796	5/16" x 5/16" x 12"	5
9800	3/8" x 3/8" x 12"	5
9801	7/16" x 7/16" x 12"	5
9802	1/2" x 1/2" x 12"	5

KEYS

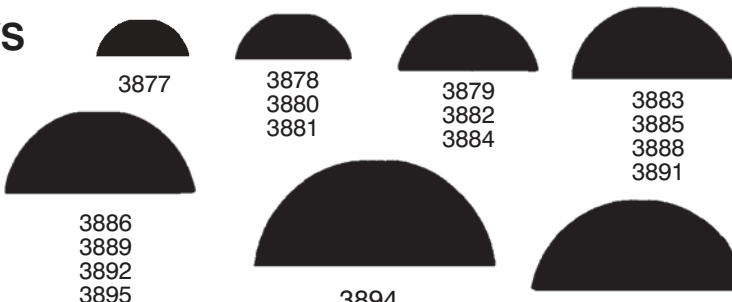

Woodruff Keys

1035 Carbon Steel
Plain

Auveco Part No.	Size	Unit Pkg.
-----------------	------	-----------

3877	(No. 3)	1/8" x 1/2"	100
3878	(No. 5)	1/8" x 5/8"	100
3879	(No. 7)	1/8" x 3/4"	100
3880	(No. 4)	3/32" x 5/8"	100
3881	(No. 6)	5/32" x 5/8"	100
3882	(No. 8)	5/32" x 3/4"	100
3883	(No. 10)	5/32" x 7/8"	100
3884	(No. 9)	3/16" x 3/4"	100
3885	(No. 11)	3/16" x 7/8"	100
3886	(No. 13)	3/16" x 1"	50
3887	(No. 16)	3/16" x 1-1/8"	50
3888	(No. 12)	7/32" x 7/8"	50
3889	(No. 14)	7/32" x 1"	50
3890	(No. 17)	7/32" x 1-1/8"	50
3891	(No. A)	1/4" x 7/8"	50
3892	(No. 15)	1/4" x 1"	50
3893	(No. 18)	1/4" x 1-1/8"	50
3894	(No. 21)	1/4" x 1-1/4"	50
3895	(No. B)	5/16" x 1"	50
3896	(No. C)	5/16" x 1-1/8"	50

For an Assortment of Woodruff Keys, see Kit No. 6065 and Large Drawer Assortment No. 6504 in the green pages.

CAPS & CONNECTORS

Vinyl Vacuum Caps



Can be used for capping lines and hoses while testing carburetors, emission control systems, vacuum lines etc. Color coded for size identification.

Auveco Part No.	I.D.	Fits Tube O.D.	Color	Length	Unit Pkg.
18202	1/8"	3/16"	Blue	5/8"	50
18203	3/16"	1/4"	Red	5/8"	50
18204	1/4"	5/16"	White	5/8"	50
18205	5/16"	3/8"	Black	5/8"	50

Rubber Caps

(Special Heat Resistant EPDM Rubber)
Ford - GM - Chrysler



Can be used for capping lines and hoses while testing carburetors, emission control systems, vacuum lines, etc.



Auveco Part No.	Fits Tube O.D.	Inside Length	Unit Pkg.
12209	1/8"	9/16"	25
4440	3/16"	9/16"	25
16264			100
19000	3/16"	1-1/4"	25
4439	1/4"	9/16"	25
19001	1/4"	1-1/4"	25

Auveco Part No.	Fits Tube O.D.	Inside Length	Unit Pkg.
19002	5/16"	9/16"	25
12907	5/16"	1-1/4"	25
12210	3/8"	31/32"	25
19003	3/8"	1-1/2"	25
12908	1/2"	11/16"	10

NYLON CONNECTORS



12929

Connector
1/8" x 1/8"

UNIT PACKAGE: 10



12936

Connector
1/8" x 1/4"

UNIT PACKAGE: 10



12935

Connector
3/16" x 1/4"

UNIT PACKAGE: 10



12930

Connector
1/8" x 3/16"

UNIT PACKAGE: 10



12937

Connector
3/16" x 3/16"

UNIT PACKAGE: 10



12931

Connector
1/4" x 1/4"

UNIT PACKAGE: 10

Sec. 11

NYLON CONNECTORS



12946

Connector
5/16" x 5/16"

UNIT PACKAGE: 10

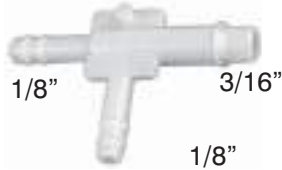

12916

Tee

UNIT PACKAGE: 10

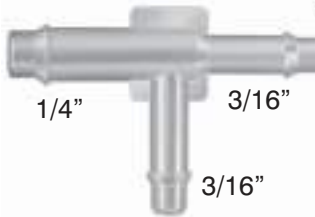

12919

Tee

UNIT PACKAGE: 10



12921

Tee

UNIT PACKAGE: 10



12938

Connector
3/8" x 1/4"

UNIT PACKAGE: 10



12924

Tee

UNIT PACKAGE: 10

1/4"
All
Ends



17629

Tee

UNIT PACKAGE: 10



12922

Tee

UNIT PACKAGE: 10



12934

Connector
3/8" x 3/8"

UNIT PACKAGE: 10

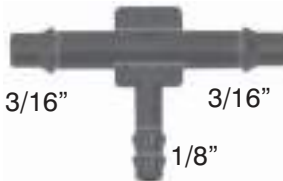

12926

Tee

UNIT PACKAGE: 10

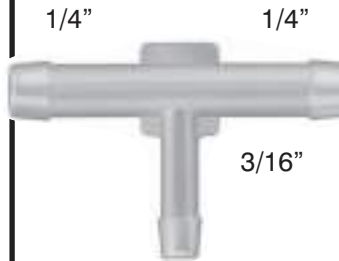

11738

Tee

UNIT PACKAGE: 10



12920

Tee

UNIT PACKAGE: 10



18835
(E1ZE-9E499-EA)
Nylon

Emission Harness
Connector
Ford

UNIT PACKAGE: 25



12917

Tee

UNIT PACKAGE: 10



1/8" All Ends

12923

Tee

UNIT PACKAGE: 10



12918

Tee

UNIT PACKAGE: 10



12941

Tee

UNIT PACKAGE: 10



3/8"
All Ends

12925

Tee

UNIT PACKAGE: 10

NYLON CONNECTORS



3/16"
All Ends

12927

Y Connector

UNIT PACKAGE: 10



12947

Elbow
1/8" x 3/16"

UNIT PACKAGE: 10



12948

Elbow
3/16" x 1/4"

UNIT PACKAGE: 10



11419

4 Way Connector
3/16" All Ends

UNIT PACKAGE: 25



1/4"
All Ends

12943

Y Connector

UNIT PACKAGE: 10



12932

Elbow
3/16" x 3/16"

UNIT PACKAGE: 10



12933

Elbow
1/4" x 1/4"

UNIT PACKAGE: 10



12940

F Connector
3/16" All Ends

UNIT PACKAGE: 10



12949

5 Way Tee
3/16" All Ends

UNIT PACKAGE: 5



5/16"
All Ends

12944

Y Connector

UNIT PACKAGE: 10



5/32"
(Both)

3/16"

18836
(E1ZE-9E499CA)

Emission Harness
Elbow Connector
Ford

UNIT PACKAGE: 25



12939

Cross Connector
3/16" All Ends

UNIT PACKAGE: 5

NYLON CONNECTOR CROSS REFERENCE

O.E.M. NUMBER CHART

Auveco Part No.	OEM No.	Auveco Part No.	OEM No.	Auveco Part No.	OEM No.
11419.....GM:	560692,	12925.....GM:	14023108	12935.....GM:	1621253,
	22508803	Ford:	388131-S		472812
Ford:	383847-S	12926.....GM:	14031114	Ford:	800843
11738.....GM:	3963228	12927.....GM:	10003617,	AMC:	3239826
12916.....GM:	14025274,		22508052	12936.....GM:	14017702
	14031144	Ford:	383031	12937.....GM:	560625,
Ford:	383016	AMC:	3236813		22508051
Chry:	4241362	12928.....GM:	14046514	Ford:	383003,
12917.....GM:	1610403	12929.....GM:	14047034		389138
12918.....GM:	357020,		Ford:	Chry:	4104998
	272766,		383000	12938.....Ford:	E0VE-9K319AB
	22508050	12930.....GM:	14017701	12939.....GM:	354400
Ford:	373846-S		Ford:	Ford:	387042
Chry:	3671410		3441743,	Chry:	4241054
AMC:	3673945		4241296	12940.....GM:	14029095
12919.....GM:	1617333,	12931.....GM:	1614858,	12941.....GM:	14031149
	10003294		14004876,	12943.....GM:	10004121
Ford:	388034		10017487	Chry:	4019472
	12920		Ford:	AMC:	4006848
GM:	6466355	12932.....GM:	556992,	12944.....Chry:	4179982
Chry:	4167810		14031145,	12946.....Chry:	4179981
12921.....GM:	472814		22508049	12947.....GM:	14017779
Ford:	D9AE-9E645AA		Ford:	12948.....Ford:	387980
12922.....GM:	472815		387065	12949.....Ford:	384111
Ford:	801471	12933.....Ford:	387074	AMC:	3237451
12923.....GM:	14017705	12934.....GM:	22505958		
Ford:	3895904		Chry:		
Chry:	3751212		4201198		
12924.....GM:	14017780				



Nylon Hose Connectors Barbed On Both Ends

Auveco Part No.	Hose Size	Unit Pkg.
10101*	1/8" x 1/8"	10
10102	3/16" x 3/16"	10
10103	1/4" x 1/4"	10
10104	5/16" x 5/16"	10
10105	3/8" x 3/8"	10
16961	1/2" x 1/2"	10

*Single Barb On Each End



Nylon Reducer Connectors Barbed On Both Ends

Auveco Part No.	Hose Size	Unit Pkg.
10106	1/4" x 3/16"	10
10107	3/8" x 1/4"	10



Nylon Tubing & Hose Tee Connectors Barbed On All Ends

Auveco Part No.	Hose Size I.D.	Unit Pkg.
10108	5/32" x 5/32" x 5/32"	10
10109	3/16" x 3/16" x 3/16"	10
10110	1/4" x 1/4" x 1/4"	10
14813	5/16" x 5/16" x 5/16"	10
11228	3/8" x 3/8" x 3/8"	10
11229	1/2" x 1/2" x 1/2"	10



10697

Nylon Tee Connector
1/8" x 1/8" x 1/8"

UNIT PACKAGE: 10

CONNECTORS
(ILLUSTRATIONS ACTUAL SIZE)



11321

Butyrate

For 1/8", 1/4" or 3/8"
Universal Tubing Connector

For use with Vacuum and Windshield Washer Tubing

Not For Use In Fuel Line

UNIT PACKAGE: 10

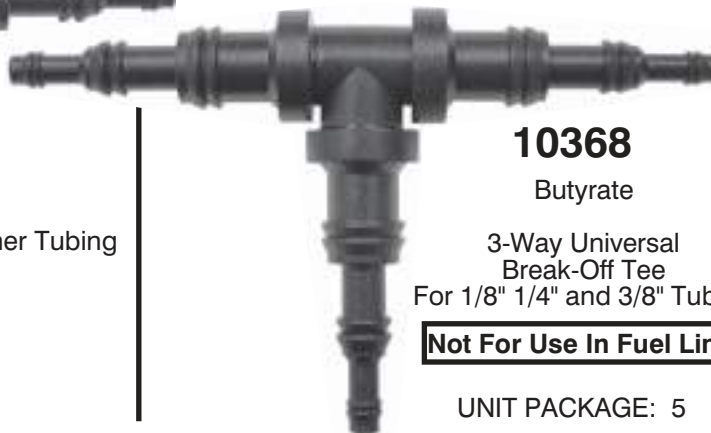

10368

Butyrate

3-Way Universal
Break-Off Tee

For 1/8" 1/4" and 3/8" Tubing

Not For Use In Fuel Line

UNIT PACKAGE: 5

RUBBER CONNECTOR



16654

Santoprene Rubber

UNIT PACKAGE: 25

**High-Density Black Polyethylene
Tubing & Hose Elbows**



Non-Corrosive

Auveco Part No.	Pipe Thread	Hose Size	Unit Pkg.
11217	1/8"	3/16" I.D.	10
11220	1/4"	3/8" I.D.	10

**High-Density Black Polyethylene
Tubing & Hose Elbow**



**Non-Corrosive
Barbed On Both Sides**

Auveco Part No.	Hose Size	Unit Pkg.
11224	3/8" x 3/8" I.D.	10



**High-Density Black Polyethylene
Tubing & Hose Tee Connector
Non-Corrosive**

Auveco Part No.	Pipe Thread	Hose Size	Unit Pkg.
11226	1/4"	1/4" x 1/4" I.D.	10

Sec. 11

AIR LINE COUPLINGS & ACCESSORIES

(Illustrations Are Not Actual Size)

210 Series: Push-to-connect, pin-type hose couplings designed for one-way shutoff in 1/4" capacity.
Average flow: 18 cfm at 90 PSIG (6.2 bar) inlet and 10 PSIG (0.69 bar) pressure drop.
 Maximum inlet pressure: 250 PSIG (17 bar). Zinc chromate finish.



16045
 1/4" Female NPT
 UNIT PKG: 5



16046
 1/4" Male NPT
 UNIT PKG: 5



16049
 1/4" Female NPT
 UNIT PKG: 5

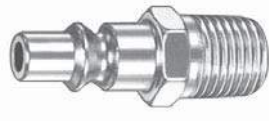

16051
 1/4" Male NPT
 UNIT PKG: 5



16052
 1/4" Hose Stem I.D.
 UNIT PKG: 5

MS Series: For use with industrial interchange style connectors. Push-to-connect type designed for one-way shutoff in 1/4" capacity. **Average flow: 36 cfm** at 90 PSIG (6.2 bar) inlet and 10 PSIG (0.69 bar) pressure drop. Maximum inlet pressure: 250 PSIG (17 bar). Zinc Chromate finish.



16066
 1/4" Female NPT
 Brass
 UNIT PACKAGE: 5



16067
 1/4" Male NPT
 UNIT PACKAGE: 5



16070
 1/4" Female NPT
 UNIT PACKAGE: 5



16071
 1/8" Male NPT
 UNIT PACKAGE: 5



16072
 1/4" Male NPT
 UNIT PACKAGE: 5



19576

Safety lever blow gun easily controls air flow making it ideal for hundreds of automotive and industrial uses in small or large industrial plants, service stations, garages, etc. Zinc alloy and brass construction.

Meets OSHA 150 PSI Inlet, Max. Nozzle 30 PSI SCFM 10.0 @ 100 PSI. 1/4" NPT air inlet.

UNIT PACKAGE: 1



19578

Siphon Spray Nozzle. Accessory For 19577 Blow Gun. For adding moisture or solvent to the air stream. Unique dual thread design permits use on all blow guns with 7/16"-27 and 1/8" NPS threads. O-ring seal creates an air-tight assembly. Aluminum body construction.

UNIT PACKAGE: 1



19577

Compact safety lever blow gun. Includes a safety nozzle and a non-safety rubber tip nozzle. Features an easy to use hang-up hook. Chrome plated zinc alloy construction.

Meets OSHA 150 PSI Inlet, Max. Nozzle 30 PSI. Safety tip SCFM 11.7 @ 100 PSI. Non-safety tip 12.9 @ 100 PSI. 1/4" NPT air inlet

UNIT PACKAGE: 1



19579

Rubber Blow Gun Tip. Accessory For 19577 Blow Gun. For positive leak-proof connection when blowing out any fluids where a metal tip could mar the finish. Unique dual thread design permits use on all blow guns with 7/16"-27 and 1/8" NPS threads. O-ring seal creates an air-tight assembly. Brass body construction.

UNIT PACKAGE: 2

CLEAR FLEXIBLE VINYL (PVC) TUBING Sec. 11



Our tubing has a broad range of chemical resistance to acids, alkalis and solvents. It's ideal for use in industrial air pressure line applications, in the food industry (FDA approved), for potable water, and for various gases and chemicals. Not for use with gasoline.

The Clear Flexible Tubing can be used with our connectors which are cataloged on pages 134. The tubing can also be installed with our Hose Clamps (refer to the alphabetical index).

Auveco Part No.	I.D.	O.D.	Wall Thickness	*Maximum Suggested Working Pressure (PSI @ 70 F)	Unit Pkg.
14801	1/8"	1/4"	1/16"	59	100 Ft.
14802	3/16"	5/16"	1/16"	51	100 Ft.
14803	1/4"	3/8"	1/16"	51	100 Ft.
14804	5/16"	7/16"	1/16"	48	100 Ft.
14805	3/8"	1/2"	1/16"	41	100 Ft.
14806	3/8"	5/8"	1/8"	55	100 Ft.
14807	1/2"	5/8"	1/16"	28	100 Ft.
14808	1/2"	3/4"	1/8"	41	100 Ft.

*We recommend verification by testing of the size and material to be used.

Red Air Hose



Male Brass Fitting

Four spiral reinforced EPDM rubber construction offers superior durability and excellent flexibility. Limited oil resistance. Coupled with brass fittings. Maximum working pressure is 300 P.S.I.

Auveco Part No.	I.D.	Description	Unit Pkg.
-----------------	------	-------------	-----------

Impact Tool Air Hose

15538	3/8"	1/4" Male Pipe Thread Fittings	25' Roll
15539	3/8"	1/4" Male Pipe Thread Fittings	50' Roll

Black O.E.M. Heater Hose

Meets or exceeds SAE20R3 specifications. O.E.M. grade EPDM hose that withstands the abuse of corrosive additives, heat, cold, ozone, weather and abrasion



Auveco Part No.	I.D.	Unit Pkg.
15540	1/2"	50' Roll
15541	5/8"	50' Roll
15542	3/4"	50' Roll

VACUUM & WINDSHIELD WASHER TUBING

For a Complete Listing of Barbed Brass Fittings See Page 238.

- Meets SAE J1037 Type 2 Specifications • EPDM Rubber
- Packed in coils of 25 and 50 ft. lengths



Auveco Part No.	I.D.	O.D.		Unit Pkg.
4453	7/64"	9/32"	Fits 1/8" Nipple	25'
4454	7/64"	9/32"	Fits 1/8" Nipple	50'
4456	5/32"	5/16"	Fits 3/16" Nipple	25'
4457	5/32"	5/16"	Fits 3/16" Nipple	50'
4459	7/32"	13/32"	Fits 1/4" Nipple	25'
4460	7/32"	13/32"	Fits 1/4" Nipple	50'
4462	9/32"	15/32"	Fits 5/16" Nipple	25'
4463	9/32"	15/32"	Fits 5/16" Nipple	50'

Fuel Line Hose

(Not For Electronic Fuel Injection)

For a Complete Listing of Barbed Brass Fittings See Page 238.



- Meets the following O.E.M. Specifications: (GM: 6165-M) (SAE J30R7) (Chrysler MSEA219)
- Packaged in coils of 25 and 50 ft. lengths
- Auveco Fuel Line Hose is of the highest quality and meets all O.E.M. specifications. It has a special chemical resistant interior, a single braid, and a neoprene exterior for maximum life and durability. For temperature range from -29°F to 257°F.
- Auveco Hose is designed for gas and diesel fuel lines (except Electronic Fuel Injection), emission control devices, and crankcase ventilation. In addition to the automotive applications, this hose is widely used on lawn mowers, marine motors, tractors and construction equipment to mention only a very few.

Auveco Part No.	Size	Working Pressure	Unit Pkg
17085	3/16" I.D. x 13/32" O.D.	50 PSI	25'
4464	1/4" I.D. x 1/2" O.D.	50 PSI	25'
4465	1/4" I.D. x 1/2" O.D.	50 PSI	50'
4466	5/16" I.D. x 9/16" O.D.	50 PSI	25'
4467	5/16" I.D. x 9/16" O.D.	50 PSI	50'
4468	3/8" I.D. x 5/8" O.D.	35 PSI	25'

Electronic Fuel Injection Hose



- Meets or exceeds SAE 30R9 specifications.
- Quality fluoroelastomer tube and CM cover handles virtually every fuel on the market.
- Burst strength exceeds 900 PSI.
- 180 PSI working pressure

Auveco Part No.	Size	Unit Pkg.	Use With Auveco Clamp No.
19271	1/4" I.D. x 1/2" O.D.	10 Ft.	15860
19272	5/16" I.D. x 9/16" O.D.	10 Ft.	15861
19273	3/8" I.D. x 5/8" O.D.	10 Ft.	15862



20900 Hose Cutter







Razor sharp blade cleanly cuts heater hoses, fuel line hoses and any other type of flexible hose up to 1-1/4" diameter. The stainless steel blade is reversible for double the life. The pliers are made of glass-filled gray nylon for strength. Includes a locking hoop for safe storage. Overall length: 9-1/2"

UNIT PACKAGE: 1











SOLDERLESS TERMINALS

Nylon Insulated - Our Finest

22-18 Gauge Wire Range (Red)

Actual Size	Stud Size	Auveco Part No.	Unit Pkg.
	#4 - #6	12149	25
	#8 - #10	12150	25
	#12 - 1/4"	17041	50
	#8 - #10	12163	25
	#4 - #6	12164	25
	Butt Connector	5791	50
		16487	1000

16-14 Gauge Wire Range (Blue)

Actual Size	Stud Size	Auveco No.	Unit Pkg.
	#4 - #6	9052	25
	#8 - #10	9055	25
	#12 - 1/4"	9056	25
	1/4" - 5/16"	9057	25
	5/16" - 3/8"	9058	25
	#4 - #6	9059	25
	#8 - #10	9060	25
	#8 - #10	9064	25
	Butt Connector	5792	50
		16488	1000
	1/4" Female Quick Connect	12148	25
	1/4" Male Quick Connect	12147	25



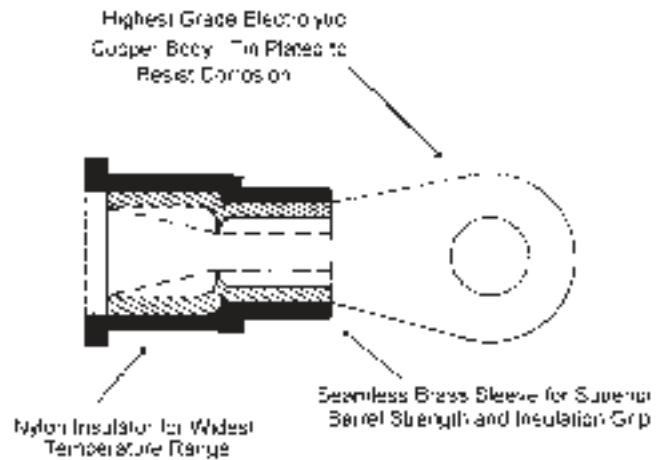

Nylon Insulated with Insulation Grip



Auveco's Finest

- * Superior Vibration Resistance with Insulation Grip
- * Superior Barrel Strength
- * Constructed to Meet the Highest Military and Industrial Standards

12-10 Gauge Wire Range (Yellow)









Actual Size	Stud Size	Auveco No.	Unit Pkg.
	#8 - #10	12151	25
	#12 - 1/4"	12152	25
	5/16" - 3/8"	12153	25
	#8 - #10	12162	25
	Butt Connector	5793	50
		16489	500

SOLDERLESS TERMINALS

For an assortment of Solderless Terminals see the Fix-Kits in the green pages.

Vinyl Insulated - Copper - Electro Tin Plated

22-18 Gauge Wire Range (Red)

Actual Size	Stud Size	Auveco Part No.	Unit Pkg.
	#4 - #6	5021	100
	#8 - #10	5023	100
	#12 - 1/4"	17040	50
	#4 - #6	5033	100
	#8 - #10	5034	100
	#4 - #6	5038	100
	Butt Connector	5047	100
		16484	1000
	Closed End Butt Connector 22-14 Ga.	9065	100

16-14 Gauge Wire Range (Blue)

Actual Size	Stud Size	Auveco Part No.	Unit Pkg.
	#4 - #6	5024	100
	#8 - #10	5026	100
	#12 - 1/4"	5027	100
	5/16" - 3/8"	12144	25
	#4 - #6	5035	100
	#8 - #10	5036	100
	#8 - #10	5040	100
	Butt Connector	5048	100
		16485	1000
	Closed End Butt Connector 16-10 Ga.	5072	100



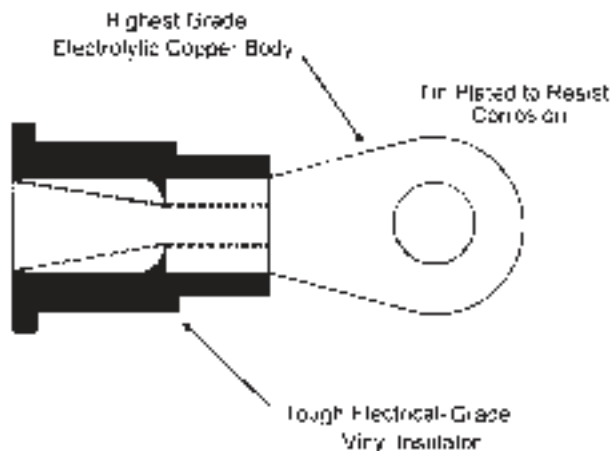







- *Funnel Barrel for Easy Wire Insertion
- *Friction Groove in Barrel Resists Wire Pullout
- *Heat Treated for Maximum Strength







SOLDERLESS TERMINALS

Vinyl Insulated - Copper - Electro Tin Plated

12-10 Gauge Wire Range (Yellow)

Actual Size	Stud Size	Auveco Part No.	Unit Pkg.
	#8 - #10	5028	100
	#12 - 1/4"	5029	100
	1/4" - 5/16"	5030	100
	5/16" - 3/8"	5031	100
	7/16" - 1/2"	5032	100
	#8 - #10	5037	100
	#8 - #10	5041	100
	Butt Connector	5049	100
		16486	500
	3-Way Connector Not Actual Size	5056	25
	4-Way Connector Not Actual Size	5058	25

8 Gauge Wire Range (Red)

Actual Size	Stud Size	Auveco Part No.	Unit Pkg.
	#12 - 1/4"	17042	25
	1/4" - 5/16"	17043	25
	5/16"-3/8"	17044	25
	7/16" - 1/2"	17045	15
	Butt Connector	17037	10



6 Gauge Wire Range (Blue)

Actual Size	Stud Size	Auveco Part No.	Unit Pkg.
	#12 - 1/4"	17046	15
	1/4" - 5/16"	17047	15
	5/16" - 3/8"	17048	15
	7/16" - 1/2"	17049	10
	Butt Connector	17038	10



SOLDERLESS TERMINALS

Vinyl Insulated - Copper - Electro Tin Plated

4 Gauge Wire Range (Yellow)

Actual Size	Stud Size	Auveco Part No.	Unit Pkg.
	#12 - 1/4"	17050	10
	1/4"-5/16"	17051	10
	5/16"-3/8"	17052	10

4 Gauge Wire Range (Yellow)



Actual Size	Stud Size	Auveco Part No.	Unit Pkg.
	7/16"-1/2"	17053	10
	Butt Connector	17039	10

Quick-Connect Terminals



1/4" Female Terminals Vinyl Insulated

Actual Size	Wire Size	Auveco Part No.	Unit Pkg.
 Red	22-18 Ga.	12155	25
 Blue	16-14 Ga.	5068	100
 Yellow	12-10 Ga.	12157	25





1/4" Male Tabs - Vinyl Insulated

Actual Size	Wire Size	Auveco Part No.	Unit Pkg.
 Red	22-18 Ga.	12154	25
 Blue	16-14 Ga.	5067	100
 Yellow	12-10 Ga.	12156	25



Fully Insulated Nylon - Mating 1/4" Quick-Connects

	22-18 Ga. Female	11827	50
	22-18 Ga. Male	11828	50
	16-14 Ga. Female	11606	50
	16-14 Ga. Male	11605	50
	12-10 Ga. Female	11829	25
	12-10 Ga. Male	11830	25

.187 (3/16") Sizes - Vinyl Insulated

 Red	Male 22-18 Ga.	17462	25
 Red	Female 22-18 Ga.	12159	25
 Blue	Male 16-14 Ga.	12165	25
 Blue	Female 16-14 Ga.	8781	50

1/4" Female Fully Insulated Nylon Piggyback Terminals

Actual Size	Wire Range	Auveco Part No.	Unit Pkg.
	22-18 Ga. 1/4" Tab Std. Barrel (Red)	19298	15
	16-14 Ga. 1/4" Tab Std. Barrel (Blue)	19299	15
	12-10 Ga. 1/4" Tab Std. Barrel (Yellow)	19300	15

Fully Insulated Tap-Disconnect

	Wire Range	Auveco Part No.	Unit Pkg.
 Mates with 11828, 11605 & 11830	22-18 Ga. (Red)	12791	10
	18-14 Ga. (Blue)	12161 14898 14899	10 100 500
	12 Ga. (Yellow)	12792	10

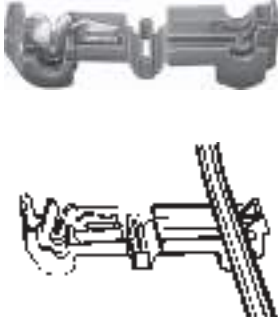

Fully insulated connector for tapping into a line without stripping the insulation. No special tools are required.

Place wire to be tapped in locating notch. Then close with pliers.

Complete connection with Auveco fully insulated male terminal:
11828 (22-18 ga.),
11605 (16-14 ga.) or
11830 (12 ga.)

Specialty Terminal - Vinyl Insulated

	Wire Range	Auveco Part No.	Unit Pkg.
	1/4" Tab 16-14 Ga.	12158	25

Fuse Block Accessory Clip

	For Add-on Electrical Equipment	Auveco Part No.	Unit Pkg.
		11405	50

Blade Type Fuse Tap

	For tapping "hot side" of fuse block	Auveco Part No.	Unit Pkg.
 Refer To Page 173.		14474	25



Mini Fuse Blade Type Fuse Tap

	For tapping "hot side" of mini fuse type fuse block	Auveco Part No.	Unit Pkg.
 Refer To Page 173.		17686	50

Sec. 12

SNAP PLUGS AND CONNECTORS



Snap Plugs - 22-18 Ga.
Universal - .157" Dia.

Actual Size	Description	Auveco Part No.	Unit Pkg.
 Red	Vinyl Insulated	11604	50
 Red	Insulated Crimp-on Female Mates with 11604	10720	10



Snap Plugs - 22-18 Ga.
Ford - .176" Dia.

Actual Size	Description	Auveco Part No.	Unit Pkg.
 Red	Insulated Crimp-On Female, Mates With 11603	11601	25

Snap Plugs 16-14 Ga.
Universal (.157")

Actual Size	Description	Auveco Part No.	Unit Pkg.
 Blue	Use with 10719 Connectors	Vinyl Insulated	5063 100
 Blue		Nylon Insulated	12146 25

Snap Plugs 16-14 Ga.
Ford (American & Lucas) (.176")

Actual Size	Description	Auveco Part No.	Unit Pkg.
 Blue	Use with 11602 Connector	Non Insulated	5059 100
 Blue		Vinyl Insulated	5062 100
 Blue		Nylon Insulated	12145 25



Fully Insulated Crimp-On Female (.157")

Actual Size	Description	Auveco Part No.	Unit Pkg.
 Blue	Nylon 16-14 Ga.	10719	10
		17494	25
Mates with 5063 & 12146			



Fully Insulated Crimp-on Female (.176")

Actual Size	Description	Auveco Part No.	Unit Pkg.
 Blue	Nylon 16-14 Ga.	11602	25
		17493	50
Mates with 5062 & 12145			

Snap Plug Tap-Disconnect

Actual Size	Description	Auveco Part No.	Unit Pkg.
	18-14 Ga.	10319	10
Use Universal Snap Plugs (above)			
			

Dual Male-Female Adaptor

Actual Size	Description	Auveco Part No.	Unit Pkg.
	Converts .250" x .032" Male Tab to 2 Male Tabs	8009	100
Dual Male Female Adapter			
	Converts .250" x .032" Male Tab to 2 Male Tabs	8788	25

KRIMP & SEAL TERMINALS







Sec. 12

Special polyolefin tubing when heated shrinks with a 3-1 ratio to completely seal entire connection, making penetration by any foreign material impossible.





24-22 Gauge Wire Range (Clear)

Actual Size	Stud Size	Auveco Part No.	Unit Pkg.
	Butt Connector	21317	10







22-18 Gauge Wire Range (Red)

Actual Size	Stud Size	Auveco Part No.	Unit Pkg.
	#6	13656	10
	#10	13657	10
	Butt Connector	13659	10
		19258	25
 Female	.250"	13660	10
 Male	.250"	13661	10
	#10	13658	10







16-14 Gauge Wire Range (Blue)

Actual Size	Stud Size	Auveco Part No.	Unit Pkg.
	#6	13662	10
	#10	13663	10
	1/4"	13664	10
	5/16"	13665	10
	3/8"	13666	10

16-14 Gauge Wire Range (Blue) (Continued)

Actual Size	Stud Size	Auveco Part No.	Unit Pkg.
	Butt Conn.	13669	10
		19259	25
 Mates With 13682	.157"	13681	10
 Mates With 13681	.157"	13682	10
	.250"	13670	10
	.250"	13671	10
 Female	.250"	13672	10
		19260	25
 Male	.250"	13673	10
		19261	25

12-10 Gauge Wire Range (Yellow)

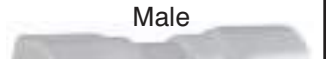
Actual Size	Stud Size	Auveco Part No.	Unit Pkg.
	#10	13674	10
	1/4"	13675	10
	3/8"	13676	10
	Butt Connector	13678	10
		19262	25
	#10	13677	10
 Female	.250"	13679	10
 Male	.250"	13680	10

Sec. 12

Sealed Crimp & Solder Terminals & Connectors

Crimped for mechanical reliability, soldered for superior strength and conductivity, and sealed with heat shrink tubing for maximum durability.

THE CRIMP CONNECTOR

- There are crimp indicators which show where the installation tool should be positioned
- Wire-stops in butt connectors prevent over-insertion of the wire
- Window in the connector allows for visual inspection & solder to flow into









THE SOLDER





- Flux coating to clean metal surfaces
- Low-temperature solder alloy for ease of installation
- Pre-measured solder to provide the right amount of solder to ensure a solid termination





THE HEAT SHRINK TUBING

- Adhesive lined polyolefin to seal the connection
- Translucent tubing to allow for visual inspection

Actual Size	Stud Size	Auveco Part No.	U.P. Qty
24-22 Gauge Wire Range (Clear)			
	Butt Connector	21002	10
20 - 18 Gauge Wire Range (Red)			
	#8	21260	10
	#10	21261	10
	1/4"	21262	10
	5/16"	21263	10
	3/8"	21264	10
	1/4" Female Slip-On	21278	10
	1/4" Male Slip-On	21279	10
	Butt Connector	21003	10
	Step Down Butt Connector		
	24 - 22 Ga. To 20 - 18 Ga.	21275	10

Actual Size	Stud Size	Auveco Part No.	U.P. Qty
16 - 14 Gauge Wire Range (Blue)			
	#8	21265	10
	#10	21266	10
	1/4"	21267	10
	5/16"	21268	10
	3/8"	21269	10
	1/4" Female Slip-On	21280	10
	1/4" Male Slip-On	21281	10
	Butt Connector	21004	10
	Step Down Butt Connector		
	20-18 Ga. To 16-14 Ga.	21276	10

Actual Size	Stud Size	Auveco Part No.	U.P. Qty
12 - 10 Gauge Wire Range (Yellow)			
	#8	21270	10
	#10	21271	10
	1/4"	21272	10
	5/16"	21273	10

Actual Size	Stud Size	Auveco Part No.	U.P. Qty
	3/8"	21274	10
	1/4" Female Slip-On	21282	10
	1/4" Male Slip-On	21283	10
	Butt Connector	21005	10
	16-14 Ga. To 12-10 Ga. Step Down Butt Connector	21277	10

Moisture Resistant Nylon Insulated Butt Connectors

Protects electrical connections from corrosive environments - road chemicals, salt spray, etc. Insert wire and crimp twice (electrical and mechanical) at each end - no need for heat or chemicals.

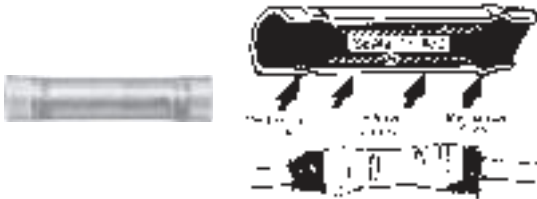

Auveco Part No.	Wire Range	Color	Unit Pkg.
13683	22-18 Ga.	Red	10
13684	16-14 Ga.	Blue	10
13685	12-10 Ga.	Yellow	10

Heat-Shrinkable, Solder-Type Closed-End Connector

Heat-shrinkable thermoplastic sleeve containing a spiral wound copper insert that is fitted with a prefluxed solder band. Easy installation: Insert stripped wires, then twist slightly. Twisting causes the copper insert to tightly grip, compress and hold the wires together. Apply heat.



Insulated & Sealed Closed-End Connector



Auveco Part No.	Wire Range	Minimum Combination	Maximum Combination	Color Code	Unit Pkg.
18716	22-14 Ga.	3 22 Ga.	1 14 Ga., & 1 22 Ga.	Green	10

* Not Sealed







SOLDERLESS TERMINALS

Non-Insulated





22-18 Gauge Wire Range

Actual Size	Stud Size	Auveco Part No.	Unit Pkg.
	#4-#6	5000	100
	#8-#10	5002	100
	Butt Connector	5044	100





16-14 Gauge Wire Range

	#4-#6	5003	100
	#8-#10	5005	100
	#12-1/4"	5006	100
	#4-#6	5014	100
	#8-#10	5015	100
 Flag Type	#8-#10	5043	100
	Butt Connector	5045	100



16-14 Gauge Wire Range - High Temperature

	#8-#10	17491	50
	#12-1/4"	17492	50
	.187" Female	10724	25
	.187" Male	10721	25
	1/4" Female	5066	100
	1/4" Male	17490	50

12-10 Gauge Wire Range

Actual Size	Stud Size	Auveco Part No.	Unit Pkg.
	#8-#10	5007	100
	#12-1/4"	5008	100
	5/16"	5009	100
	3/8"	5010	100
	Butt Connector	5046	100



Parallel Connectors
(Fusible Link Connectors)

Actual Size	Wire Range	Auveco No.	Unit Pkg.
 Non-Insulated	16-14 Ga.	12630	100
 Non-Insulated	12-10 Ga.	12631	50







Parallel Connectors
Proper Wire Insertion

Splice Clips

Actual Size	Wire Range	Auveco Part No.	Unit Pkg.
	Max. of 3 #16 Ga.	18952	50
	Max of 3 #12 Ga.	18953	50

Non-Insulated



8 Gauge Wire Range

Actual Size	Stud Size	Auveco Part No.	Unit Pkg.
	1/4"	15158	25
	5/16"	15159	25
	3/8"	15160	25
	1/2"	15161	25

6 Gauge Wire Range

	1/4"	15162	25
	5/16"	15163	25

6 Gauge Wire Range (Continued)

Actual Size	Stud Size	Auveco Part No.	Unit Pkg.
	3/8"	15164	25
	1/2"	15165	25

4 Gauge Wire Range

	1/4"	15166	10
	5/16"	15167	10
	3/8"	15168	10

This catalog includes **Specification Charts** to assist you in the identification of various types of fasteners. The charts can be found on the following pages:

Body Bolts (pages 20 & 49 - 50)

Special Tapping Screws (pages 23 - 26 & 54 - 57)

License Plate Screws (pages 33 - 34)

"Xmas Tree" Retainers (pages 404 - 413)

Push-Type Retainers (pages 450 - 460)

The charts list the pertinent dimensions, plating or color information and the page number on which the actual size picture and application information is shown for each item.

Sec. 12

SOLDERLESS TERMINALS



Make quick, reliable pre-insulated tap splices, in-line splices, pass-through connections and pigtail connections without stripping, twisting, soldering or using special tools.

Easy to use - Open the connector making sure the piercing barb is clear of the wire channels. Insert unstripped wires in the proper channels. Use pliers to squeeze down the piercing barb until the top is flush with the connector body. Close the hinged cover so it locks securely.

Auveco Part No.	Wire Size	Color	Unit Pkg.
17036	22-18 Ga.	Red	25
9481	18-14 Ga.	Blue	25
14896	18-14 Ga.	Blue	100
14897	18-14 Ga.	Blue	500

Tap connector with patented application system forces protective gel around the wire and element, providing a moisture-resistant barrier to destructive substances such as salt water and other corrosive environments. Withstands continuous operating temperatures of -40°C to 75°C (-40°F to 167°F).

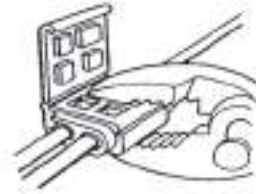

Auveco Part No.	Wire Size	Color	Unit Pkg.
17360	18-14 Ga.	Blue	50



10385

Tan

Heavy duty self-stripping connector designed for 14, 16, 18 gauge wire connected on to 10 or 12 gauge automotive wire. Ideal for over the road equipment where tap, in-line, and pigtail splices are required.

UNIT PACKAGE: 10



Fully insulated connector for tapping into a line without stripping the insulation. No special tools are required.

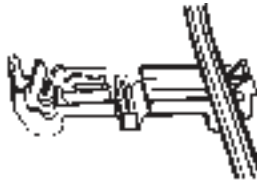

Place wire to be tapped in locating notch. Then close with pliers.



Complete connection with Auveco fully insulated male terminal:
11828 (22-18 ga.),
11605 (16-14 ga.) or
11830 (12 ga.)

Auveco Part No.	Wire Size	Color	Unit Pkg.
-----------------	-----------	-------	-----------

12791	22-18 Ga.	Red	10
12161	18-14 Ga.	Blue	10
14898	18-14 Ga.	Blue	100
14899	18-14 Ga.	Blue	500
12792	12 Ga.	Yellow	10



10386

Yellow

Designed exclusively for 10 or 12 gauge splicing on heavy duty vehicle wiring. Tap, in-line, and pigtail splices made quick and easy with this self-stripping connector.

UNIT PACKAGE: 10



10319



Bullet receptacle connector for use with 18-14 gauge wire. Mates with Auveco snap plugs 5063 and 12146. Place wire to be tapped into connector channel, snap body together and lock into place with pliers.

UNIT PACKAGE: 10

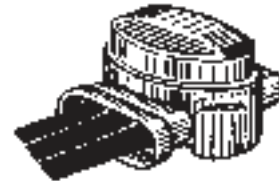

14920 (with Sealant)

Self-stripping connector for making 2 or 3 wire pigtail connections with a wire range of 22-14 gauge. Simply insert 2 or 3 unstripped wires completely into the connector. Hold a crimping tool perpendicular to the wires and make the connection by driving the cap down. For use to 600V maximum.

UNIT PACKAGE: 10

O.E.M. TERMINALS & SHELLS

GM Weather Pack Series

Sec. 12

Male Terminals Are Used With Shrouds. Female Terminals Are Used With Towers.

 <p>20747 (GM: 12089307) Tin Plated</p> <p>24-22 Ga. Mates With 20748</p> <p>UNIT PACKAGE: 15</p>	 <p>14150 (12033674, 12089040) Tin Plated</p> <p>20-18 Ga. Mates with 14151.</p> <p>UNIT PACKAGE: 50</p>	 <p>15948 (12010085, 12089305) Tin Plated</p> <p>16-14 Ga. Mates with 15937</p> <p>UNIT PACKAGE: 50</p>	 <p>18325 (12089306, 12124587) Tin Plated</p> <p>12 Ga. 20 Amp Max. Mates With 18324</p> <p>UNIT PACKAGE: 25</p>
 <p>20748 (GM: 12020801) Tin Plated</p> <p>24-22 Ga. Mates With 20747</p> <p>UNIT PACKAGE: 15</p>	 <p>14151 (12034051, 12089188) Tin Plated</p> <p>20-18 Ga. Mates with 14150</p> <p>UNIT PACKAGE: 50</p>	 <p>15937 (12010182, 12124580) Tin Plated</p> <p>16-14 Ga. Mates with 15948</p> <p>UNIT PACKAGE: 50</p>	 <p>18324 (12015917, 12124581) Tin Plated</p> <p>12 Ga. 20 Amp Max. Mates With 18325</p> <p>UNIT PACKAGE: 25</p>
 <p>20749 (GM: 12015899) Red Silicone</p> <p>Cable Seal Use With 24-22 Gauge Auveco Terminals 20747 & 20748</p> <p>UNIT PACKAGE: 25</p>	 <p>14152 (12015323) Green Silicone</p> <p>Cable seal Use w/14150, 14151, 15937 & 15948</p> <p>UNIT PACKAGE: 50</p>	 <p>18326 (12010293) Gray Silicone</p> <p>Use With 14 Gauge GPT & Cross-Link Polyethylene Primary Wire</p> <p>UNIT PACKAGE: 25</p>	 <p>20618 (12015193) Blue Silicone</p> <p>Use w/12 Gauge Auveco Terminals 18324 & 18325</p> <p>UNIT PACKAGE: 25</p>
 <p>15955 (12010300) Silicone</p> <p>Cavity Plug Used to plug empty cavities in connector shell</p> <p>UNIT PACKAGE: 25</p>	 <p>14153 (12014836)</p> <p>20-18 Ga. Set of 14150 & 14152</p> <p>UNIT PKG: 25 Sets</p>	 <p>14154 (12014837)</p> <p>20-18 Ga, Set of 14151 and 14152</p> <p>UNIT PKG: 25 Sets</p>	
 <p>15921</p> <p>20-18 Ga. Repair Lead 10" of 18 Ga. wire.</p> <p>UNIT PACKAGE: 5</p>	 <p>15922</p> <p>20-18 Ga. Repair Lead 10" of 18 Ga. wire.</p> <p>UNIT PACKAGE: 5</p>		







Sec. 12

O.E.M. SHELLS

 <p>Not Actual Size</p> <p>15949 (12010996) Nylon</p> <p>Single Cavity Shroud Mates w/15950</p> <p>UNIT PACKAGE: 25</p>	 <p>Not Actual Size</p> <p>15950 (12015791) Nylon</p> <p>Single Cavity Tower Mates w/15949</p> <p>UNIT PACKAGE: 25</p>	 <p>Not Actual Size</p> <p>15951 (12010973) Nylon</p> <p>Double Cavity Shroud Mates w/15952</p> <p>UNIT PACKAGE: 25</p>	 <p>Not Actual Size</p> <p>15952 (12015792) Nylon</p> <p>Double Cavity Tower Mates w/15951</p> <p>UNIT PACKAGE: 25</p>
 <p>Not Actual Size</p> <p>15953 (12010717) Nylon</p> <p>Triple Cavity Shroud Mates w/15954</p> <p>UNIT PACKAGE: 15</p>	 <p>Not Actual Size</p> <p>15954 (12015793) Nylon</p> <p>Triple Cavity Tower Mates w/15953</p> <p>UNIT PACKAGE: 15</p>	 <p>Not Actual Size</p> <p>18145 (12015797) Nylon</p> <p>4 Cavity Flat Tower Mates with 18146</p> <p>UNIT PACKAGE: 5</p>	 <p>Not Actual Size</p> <p>18146 (12010974) Nylon</p> <p>4 Cavity Flat Shroud Mates with 18145</p> <p>UNIT PACKAGE: 5</p>
 <p>Not Actual Size</p> <p>18147 (12015798) Nylon</p> <p>4 Cavity Square Tower Mates with 18148</p> <p>UNIT PACKAGE: 5</p>	 <p>Not Actual Size</p> <p>18148 (12015024) Nylon</p> <p>4 Cavity Square Shroud Mates with 18147</p> <p>UNIT PACKAGE: 5</p>	 <p>Not Actual Size</p> <p>18149 (12034342) Nylon</p> <p>5 Cavity Round Tower Mates with 18150</p> <p>UNIT PACKAGE: 2</p>	 <p>Not Actual Size</p> <p>18150 (12065158) Nylon</p> <p>5 Cavity Round Shroud Mates with 18149</p> <p>UNIT PACKAGE: 5</p>
 <p>Not Actual Size</p> <p>18151 (12015799) Nylon</p> <p>6 Cavity Flat Tower Mates with 18152</p> <p>UNIT PACKAGE: 3</p>		 <p>Not Actual Size</p> <p>18152 (12010975) Nylon</p> <p>6 Cavity Flat Shroud Mates with 18151</p> <p>UNIT PACKAGE: 5</p>	
 <p>Not Actual Size</p> <p>15923 (12015387) Nylon</p> <p>Four Cavity Tower. For male terminal. Connects wiring harness to Idle Control Solenoid (ICS) Actuator on GM vehicles 1985-On</p> <p>UNIT PACKAGE: 5</p>	 <p>14462 (12014012)</p> <p>Weather Pack Terminal Extractor Tool Designed for extracting Weather Pack terminals from their connector housing. Slide the hollow shaft of the tool over the retention bars of the terminal. Then pull the terminal out of its shell.</p> <p>UNIT PACKAGE: 1</p>		

O.E.M. TERMINALS

Sec. 12

 <p>15957 (2965142) Tin Plated</p> <p>16-14 Ga. Insulated with shell 8777 Mates w/term. 15956</p> <p>UNIT PACKAGE: 25</p>	 <p>8774 (2084421, 2962447) Unplated Brass</p> <p>16-14 Ga. Insulated with shell 8777 Mates w/term. 8776</p> <p>UNIT PACKAGE: 50</p>	 <p>17002 (8917283; 12015878) Tin Plated Copper</p> <p>12-10 Ga. Insulated with shell 8775</p> <p>UNIT PACKAGE: 25</p>	 <p>8775 (2962984)</p> <p>Insulates 8776 and 15956 Mates with shell 8777</p> <p>UNIT PACKAGE: 25</p>
 <p>15956 (2971962) Tin Plated</p> <p>16-14 Ga. Insulated with shell 8775 Mates w/term. 15957</p> <p>UNIT PACKAGE: 25</p>	 <p>8776 (2962987) Tin Plated</p> <p>16-14 Ga. Insulated with 8775 Mates w/term. 8774</p> <p>UNIT PACKAGE: 50</p>		 <p>8777 (2962448)</p> <p>Insulates 8774 and 15957 Mates with shell 8775.</p> <p>UNIT PACKAGE: 25</p>

GM Electronic Control Module Terminal



14882
(12034053,
12004610)
Tin Plated

20-18 Ga.

UNIT PACKAGE: 10

GM Micro - Pack Terminals



14883
(12020757)
Tin Plated

20-18 Ga.

UNIT PACKAGE: 10



15924
(12040902)
Tin Plated

22 Ga.

UNIT PACKAGE: 50

GM Pack-Con I Series Terminals



11948
(8900524,
12020320)
Tin Plated

16-14 Ga.
Mates w/15935

UNIT PACKAGE: 25



15935
(12020347)

16-14 Ga.
Mates w/11948

UNIT PACKAGE: 50



18648
(8911640)
Tin Plated

16-14 Ga.

UNIT PACKAGE: 25

GM Pack-Con H.D. I Series Terminals



15960
(12033817)
Tin Plated

12-10 Ga.

UNIT PACKAGE: 25



15959
(8905087)
Tin Plated

16-14 Ga.

UNIT PACKAGE: 25

GM Pack Con III Series Terminals



18650
(12020321)
Brass

16-14 Ga.

UNIT PKG: 25

O.E.M. TERMINALS

GM Metri-Pack 150 Series Terminals



18653
(12045773)
Tin Plated

20-18 Ga.

UNIT PKG: 25



15498
(12047581)
Tin Plated

20-18 Ga.
Mates w/15497

UNIT PKG: 25



15497
(12047680)
Tin Plated

20-18 Ga.
Mates w/15498

UNIT PKG: 25



18654
(12048074)
Tin Plated

20-18 Ga.

UNIT PKG: 25



15499
(GM: 12047767;
Chrys: 4368618)
Tin Plated

20-16 Ga.

UNIT PKG: 25

GM Metri-Pack 150 Series



20212
(12129484)
Tin Plated

18 - 16 Ga.

UNIT PKG: 15



20213
(12129373)
Tin Plated

22 - 20 Ga.

UNIT PKG: 15



20214
(12124075)
Tin Plated

18 - 16 Ga.

UNIT PKG: 15



20215
(12124076)
Tin Plated

22 - 20 Ga.

UNIT PKG: 15

**GM Metri-Pack 150.2
Pull To Seat**

**GM Metri-Pack
150.1 Series
Terminal**



16806
(12052922,
12089340)

20-18 Ga.

Not For Use w/150.2
Series

UNIT PKG: 25

**GM 56 Series
Terminal**



18690
(2973215)
Tin Plated

Two 16-14 Ga. Leads
Or One 12 Ga. Lead
Fits 5/16" Male Tab

UNIT PKG: 25

GM 59 Series Terminal



18651
(2973216)
Tin Plated

16-14 Ga.
5/16" Blade Size

UNIT PKG: 25

GM Metri-Pack 280 Series Terminals



18659
(12129497)
Tin Plated

16-14 Ga.
Mates With 18658

UNIT PKG: 25



14880
(12020116)
Tin Plated

18-14 Ga.
Mates w/14881

UNIT PKG: 25



15946
(12034047)
Tin Plated

20-18 Ga.
Mates w/15947

UNIT PKG: 50



18658
(12129493)
Tin Plated

16-14 Ga.
Mates With 18659

UNIT PKG: 25



14881
(12015857)
Tin Plated

18-14 Ga.
Mates w/14880

UNIT PKG: 25



15947
(12034046)
Tin Plated

20-18 Ga.
Mates w/15946

UNIT PKG: 50



20216
(12015858)
Tin Plated

12-10 Ga.

UNIT PKG: 15



20220
(12186456)
Tin Plated

14-12 Ga.
Mates w/20226

UNIT PKG: 15

GM Metri-Pack 280 Series Terminals



20226
(12092344)
Tin Plated

14 – 12 Ga.
Mates w/20220

UNIT PKG: 15



20221
(12186457)
Tin Plated

18 – 16 Ga.
Mates w/ 20227

UNIT PKG: 15



20227
(12092345)
Tin Plated

18 – 16 Ga.
Mates w/ 20221

UNIT PKG: 15

GM Metri-Pack 280 Series Tangless



20217
(12110842)
Tin Plated

14-12 Ga.
Used without
cable seal

UNIT PKG: 15



20222
(12110845)
Tin Plated

14 – 12 Ga.
Used with cable
seal

UNIT PKG: 15



20223
(12129409)
Tin Plated

16 – 14 Ga.
Used with
cable seal

UNIT PKG: 15



20218
(12110844)
Tin Plated

18 – 16 Ga.
Used without
cable seal

UNIT PKG: 15



20224
(12110847)
Tin Plated

18 – 16 Ga.
Used with cable
seal

UNIT PKG: 15

GM Metri-Pack 280 Series Tangless



20219
(12110843)
Tin Plated

22 – 20 Ga.
Used without Cable seal

UNIT PKG: 15



20225
(12110846)
Tin Plated

22 – 20 Ga.
Used with
Cable seal

UNIT PKG: 15



20230
(12103360)
Tin Plated

22 – 20 Ga.

UNIT PKG: 15

GM Metri-Pack 280 Fuel Injector

GM Metri-Pak 480 Series



15939
(12020120)
Tin Plated

16-14 Ga.
3/16" Blade Width
Mates w/15938

UNIT PKG: 25



15938
(12015861)
Tin Plated

16-14 Ga.
Mates w/15939

UNIT PKG: 25



18660
(12048451)
Tin Plated

16-14 Ga.
For 3/16" Blade

UNIT PKG: 25

GM Metri-Pack 630 Series

GM Metri-Pack 630 Pull To Seat



15944
(12020126)
Tin Plated

16-14 Ga.
1/4" Blade Width
Mates w/15945

UNIT PKG: 50



15945
(12015870)
Tin Plated

16-14 Ga.
Mates w/15944

UNIT PKG: 50



20231
(12066614)
Tin Plated

16-14 Ga.

UNIT PKG: 15

GM Micro-Pack 100 W Series Terminals



20209
(12084912)
Gold/Nickel Plated

18 Ga.
Mates w/ 20211

UNIT PKG: 10



20211
(12160551)
Gold/Nickel Plated

18 Ga.
Mates w/ 20209

UNIT PKG: 10



20210
(12084913)
Gold/Nickel Plated

22 - 20 Ga.

UNIT PKG: 10

Ford Wedgelock Pin Type Terminals



20475
(E7EB-14461-BA)
Tin Plated
20-18 Ga.
.060" Dia. Pin

UNIT PACKAGE: 25



14887
(D1AB-14461-AA)
20-18 Ga.
.110" Dia. Pin
Mates w/14888

UNIT PACKAGE: 25



14888
(D1AB-14488-CA)
20-18 Ga.
.110 Dia. Pin
Mates w/ 14887

UNIT PACKAGE: 25



18853
(E3VB-14461-AA)
20-18 Ga.
.062" Dia. Pin
Ref. A-9

UNIT PACKAGE: 25

Ford Mini Block Terminals



16342
(E7EB-14421-EA)
20-18 Ga.
1/8" Blade Width
Mates w/16344
UNIT PKG: 25



16344
(E7EB-14474-CA)
20-18 Ga.
For 1/8" Blade
Mates w/16342
UNIT PKG: 25

Ford Standard Box Terminals



16348
(E8EB-14474-VA)
Tin Plated
16-14 Ga.
For 3/16" Blade
UNIT PACKAGE: 25



14889
(D8BB-14474-BA,
D3AB-14474-DA)
20-18 Ga.
UNIT PACKAGE: 25



20815
(D20B-14421-BB)
20 - 18 Ga.
3/16" Blade Width
**Replaces Auveco
14890**
UNIT PACKAGE: 25



20816
(D5AB-14474-FA,
D3AZ-14474-G)
20 - 18 Ga.
**Replaces Auveco
14891**
UNIT PACKAGE: 25

Chrysler Terminals



16801
(7368261)
20-18 Ga.
3/32" Dia. Pin; Male
UNIT PACKAGE: 25



16804
(4304729)
24-18 Ga.
Double Cantilever
Spring Terminal
Used with P.C. board connections &
general purpose
UNIT PACKAGE: 25



Chrysler Quick Connect Terminals
16349
(3843386)
16-14 Ga.
1/4" Blade Width
Mates w/16350
UNIT PACKAGE: 25



14892
 (GM: 2965470;
 Ford: C5AB-14474-B;
 Chrys: 2096466)
 Brass

20-18 Ga.
 1/4" Female

UNIT PACKAGE: 25



15504
 (GM: 2965580;
 Ford: C1SF-14474-A;
 Chrys: 2096467)
 Unplated

14-12 Ga.
 1/4" Female

UNIT PACKAGE: 25



17115
 (GM: 2962953;
 Ford: C2TB-14462A;
 Chry: 2096454)
 Bare Copper

12-10 Ga.
 3/8" (10mm) Stud Size

UNIT PACKAGE: 25



21401
 (GM: 2984172;
 Ford: C8AB-14463N;
 Chry: 4274166)
 Tin Plated

16-14 Ga.
 1/4" (6.3mm) Stud Size
 Locking Type

UNIT PACKAGE: 10



18451
 (GM: 8917225;
 Ford: C8AB-14463-M)
 Bare Brass

16-14 Ga.
 5/16" Stud Size
 Locking Type

UNIT PACKAGE: 25

Mate-N-Lock Terminals

Commonly used in cellular phone and communication equipment installations, office machines and machine controls.



18855
 Tin Plated Brass

20-14 Ga.
 .084" Dia. Pin
 Single Retention Barb
 Mates With 18856

UNIT PACKAGE: 25



18856
 Tin Plated Brass

20-14 Ga.
 .084" Dia. Pin
 Single Retention Barb
 Mates With 18855

UNIT PACKAGE: 25



18857
 Tin Plated Brass

20-14 Ga.
 .084" Dia. Pin
 Dual Retention Barbs
 Mates With 18858

UNIT PACKAGE: 25



18858
 Tin Plated Brass

20-14 Ga.
 .084" Dia. Pin
 Dual Retention Barbs
 Mates With 18857

UNIT PACKAGE: 25

Terminal Extractor Picks



20583
 (12094429)

Used to release most GM, Ford and Chrysler OEM terminals from their insulating shells. Not suitable for round, pin-type terminals.

14884
 (12012000)
 Narrow Blade (.050")
 UNIT PACKAGE: 1

14885
 (8913369)
 Wide Blade (.090")
 UNIT PACKAGE: 1

Micro Terminal Extractor Pick .035" Wide Blade Used to release 150 Metri-Pack, 280 Metri-Pack, 280 Tangless, 280 Bus Bar, 630 Pull to Seat, GT 150, GT 280, Wedge Base Light Socket terminals and indexing Candelabra Bayonet Double Contact Light Socket terminals.

UNIT PACKAGE: 1

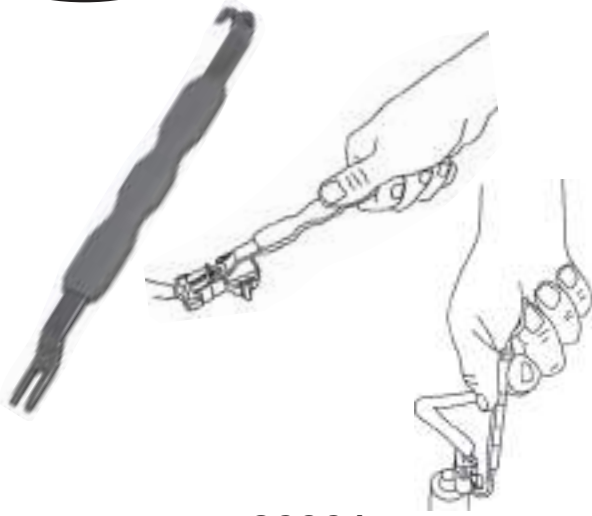

20901

Electrical Connector Separator

Quickly disconnects electrical connectors without damage. Simply engage the tool tip behind the connector locking clip and then pull or push to disconnect. The tool is double-ended to fit different access angles. Works on Weather Pack and other automotive electrical connectors.

UNIT PACKAGE: 1



15035

Self-Adjusting Wire Stripper/Crimping Tool

The quick and easy way to strip wire. Unique steel jaws self-adjust to strip any wire 26-10 gauge. Only light handle pressure is needed to make wire stripping fast and easy.

Crimps insulated and non-insulated 22 to 10 gauge and 7mm/8mm terminals

Also features precision machined blade for cutting wire sharp and smooth. Overall Length: 8-1/4"

UNIT PACKAGE: 1



21424

Wire Stripper for recessed areas. This specially designed, narrow profile tool provides easy access to limited and hard-to-reach areas. Strips 22-12 gauge single-or multiple-stranded conductor wire and automatically adjusts to the wire size. The tool has an adjustable strip length gauge and built in wire cutter.

Lightweight and easy to use.

UNIT PACKAGE: 1

Open Barrel Terminal Crimping Tool

For O.E.M. Terminals

16004



Duplicates factory crimps on open barrel terminals used in automotive, computer and control applications. Features five machined and hardened crimp stations for 14 to 24 gauge wire terminations. Parallel jaws eliminate faulty crimps. Overall Length: 8-1/2"

UNIT PACKAGE: 1

Insulation Crimp



For Wire Range	Use Crimp Station
14-18 Ga.	A
20-24 Ga.	B

Stripped Wire Crimp



For Wire Range	Use Crimp Station
14-16 Ga.	C
18-20 Ga.	D
22-24 Ga.	E

CRIMPING & CUTTING TOOLS



7711

Cuts and strips 22-8 gauge wire. Crimps insulated and non-insulated solderless terminals in sizes from 22-10 gauge. Overall Length: 9"

UNIT PACKAGE: 1



20751

(GM: 12014254)

Weather Pack Crimping Tool designed specifically to crimp only Weather Pack 20-18 Gauge & 16-14 Gauge Weather Pack seals and terminals in one cycle. Ratchet mechanism ensures completion of cycle.

UNIT PACKAGE: 1



20750

Micro Crimper
30-16 Gauge
Best For 24-20 Gauge

Insulation Crimp:

Use Crimp station A For 20-16 Ga.
Use Crimp Station B For 30-22 Ga.

Stripped Wire Crimp:

Use Crimp Station C For 18-16 Ga.
Use Crimp Station D For 22-20 Ga.
Use Crimp Station E For 30-24 Ga.

UNIT PACKAGE: 1



20752

(GM: 12085270)

20-14 Gauge
Crimps most sealed GM terminals
Ratchet mechanism ensures completion of crimp cycle

Seal Crimp:

Use Crimp Station 1 For 150 Series Metri-Pack Seals
Use Crimp Station 3 For 480 & 630 Series Metri-Pack Seals
Use Crimp Station 5 For Weather Pack & 280 Series Metri-Pack Seals

Stripped Wire Crimp:

Use Crimp Station 2 For 20-18 Ga.
Use Crimp Station 4 For 16-14 Ga.

UNIT PACKAGE: 1

CONNECTORS

Push Type Wire Connector



New type connector that lets you push wires into contact for a positive copper-to-copper connection without twisting or taping. Test holes in the front and back of the connectors accept round or flat probes of test equipment to facilitate troubleshooting.

Auveco Part No.	No. of Wires	Gauge	Rated Voltage	Color	Unit Pkg.
15849	4	18-12	600	Blue	25

Twist-Type Wire Connectors



10378 UNIT PACKAGE: 25
15204 UNIT PACKAGE: 100
 Gray

Joins 18 & 16 Ga. Wires
 Minimum of 2 #18 Ga. Wires
 Maximum of 2 #16 Ga. Wires

10379 UNIT PACKAGE: 25
15205 UNIT PACKAGE: 100
 Blue

Joins 18-14 Ga. Wires
 Minimum of 2 #18 Ga. Wires
 Maximum of 3 #16 Ga. Wires

10380 UNIT PACKAGE: 25
15206 UNIT PACKAGE: 100
 Orange

Joins 18-14 Ga. Wires
 Minimum of 2 #18 Ga. Wires
 Max. of 3 #16 Ga & 1 #18 Ga. Wires

10381 UNIT PACKAGE: 25
15207 UNIT PACKAGE: 100
 Yellow

Joins 18-12 Ga. Wires
 Min. of 1 #14 Ga. & 1 #18 Ga. Wires
 Max. of 2 #14 Ga. & 3 #16 Ga. Wires

10382 UNIT PACKAGE: 25
15208 UNIT PACKAGE: 100
 Red

Joins 18-10 Ga. Wires
 Min. of 1 #12 Ga. & 2 #18 Ga. Wires
 Max. of 2 #10 Ga. & 1 #12 Ga. Wires

Wing Twist-Type Wire Connectors



10384 UNIT PACKAGE: 25
15209 UNIT PACKAGE: 50
 Blue

Joins 14-6 Ga. Wires
 Minimum of 1 #10 Ga. &
 1 #12 Ga. Wires
 Max. of 1 #6 Ga. & 2 #8 Ga.

15705
 Yellow
 Joins 22-12 Ga. Wires
 Minimum of 2 #18 Ga. Wires
 Maximum of 2 #12 Ga. Wires

UNIT PACKAGE: 50

15706
 Red
 Joins 20-8 Ga. Wires
 Min. of 2 #16 Ga. Wires
 Max. of 4 #12 Ga. Wires

UNIT PACKAGE: 50

Twist-Type Wire Connectors

Combines both the wide range and torque of wing-style connectors with a new flexible skirt that provides over-strip protection without taking additional space in the electrical box.



18312
 Orange & Blue

Joins from two 22 ga.
 to two 12 ga. wires

UNIT PACKAGE: 25



20818

Computer Safe Automotive Logic Probe

This circuit tester with its high impedance feature draws less than 7 milliamps to protect all vehicle circuits including computerized engine and body controls, sensitive electronic sensors, microprocessors, electronic ignition components and air bags. Instructions included.

For 6, 12 and 24 volt systems
 Insulated probe has an exposed length of 3-3/8"
 Includes Protect-A-Terminal® Probe Adapter to prevent damage to electrical connectors
 Has 6 feet of heavy duty, 18 gauge dual leads with large battery clips for easy hook-up.

UNIT PACKAGE: 1



20819

Heavy Duty Circuit Tester

An excellent quality electrical circuit tester for checking 6 and 12 volt systems. It's made to last! Has a heavy duty battery clip. 5 feet of tough, flexible, heavily insulated rubber coated wire is retained in a spring supported strain-relief design that withstands the most rugged use.

UNIT PACKAGE: 1

For Troubleshooting DC Primary Circuits On 6 & 12 Volt Vehicles

16420

Use to Check:

- Lighting Systems
- Wipers
- Horn
- Electric Clock,
- Windows, Locks
- Fuses
- Relays

Features:

- 4 Feet of Wire
- Mechanical Strain Relief
- Impact & Chemical Resistant Housing
- 8" Long Probe/Housing
- Super Sharp Probe, Tempered To Last
- 2" Long Alligator Clip

UNIT PACKAGE: 1



Sec. 12

Wire Loom & Primary Wire

(Split Flexible Tubing)

Can withstand Maximum Temperature of 345°F



I.D. 1/4" - O.D. 3/8"
Nylon 6 - Black

14197 10' Length
14201 50' Length (Bulk)



I.D. 3/8" - O.D. 9/16"
Nylon 6 - Black

14198 10' Length
14202 50' Length (Bulk)



I.D. 1/2" - O.D. 11/16"
Nylon 6 - Black

14199 10' Length
14203 50' Length (Bulk)



I.D. 5/8" - O.D. 13/16"
Nylon 6 - Black

20536 50' Length



I.D. 3/4" - O.D. 15/16"
Nylon 6 - Black

14200 10' Length
14204 50' Length (Bulk)



I.D. 1" - O.D. 1-1/8"
Nylon 6 - Black

18194 25' Length

PRIMARY WIRE

General Purpose

Standard PVC Insulation (SE/GPT Type)
Suitable for Most Automotive Applications
Free Stripping, Abrasion Resistant
Meets Most O.E.M. Vehicle Standards

UNIT PACKAGE: 1 Roll

The lower the gauge number, the thicker the wire
(i.e. 10 gauge is thicker than 16 gauge)



Gauge	Stranding	O.D.	Auveco Part No				Length
			Red	White	Black	Blue	
18	16 x 30	.092	20486	20487	20488	20489	45 Ft.
16	19 x 29	.104	20490	20491	20492	20493	35 Ft.
12	19 x 25	.142	20494	20495	20496	20497	15 Ft.
10	19 x 23	.175	20498	20499	20500	20501	10 Ft.

25 Foot Spool

Gauge	Stranding	O.D.	Auveco Part No					
			Red	White	Black	Blue	Green	Yellow
14	19 x 27	.117	12419	12420	12421	12422	15239	15240

100 Foot Spool

Gauge	Stranding	O.D.	Auveco Part No						
			Red	White	Black	Blue	Green	Yellow	Brown
20	10 x 30	.085	21339	21340	21341	21342	21343	21344	21345
18	16 x 30	.092	12423	12424	12425	12426	12427	12428	15256
16	19 x 29	.104	12429	12430	12431	12432	12433	12434	15257
14	19 x 27	.117	12435	12436	12437	12439	12440	15258
12	19 x 25	.142	12441	12442	12443	12444	15259	15260
10	19 x 23	.175	12445	12447	12448	15263

SPOOLED FUSIBLE LINK WIRE

The lower the gauge number, the thicker the wire (i.e. 10 ga. is thicker than 16 ga.)



A fusible link is a special section of low tension cable installed by an OEM and designed to open a circuit when subjected to extreme current overload. Its purpose is to minimize wiring system damage when such an overload accidentally occurs in those circuits protected by the fusible link. A short circuit causes the fusible link to act as an element in a "slow-blow" fuse. A fusible link is not intended to be used in place of a fuse but only where a fuse cannot be economically employed. Our fusible line wire meets the requirements of SE J-156 and the insulation has the characteristics as listed for EAE, SE J-1128 Type SXL. The vehicle manufacturer should be consulted about questions on fusible link length and size. General practice has been for a fusible link to be 4 gauges smaller than the circuit wire. Example: if the circuit wire is 12 gauge, use a 16 gauge fusible link. Final determination should be based on O.E.M. application. Note: Extreme care should be taken to always replace a fusible link with the same gauge and length as installed by the manufacturer.

Auveco Part No.	Gauge	Color*	Length	Replaces	Unit Pkg.
15370	18	Blue or Rust	25 Ft.	GM: 6293702	1 Spool
15372	14	Gray or Rust	25 Ft.	GM: 6292995	1 Spool
20484	8	Black or Rust	25 Ft.		1 Spool

*Color may vary at manufacturer's option.

Universal Fusible Links



Auveco Part No.	Gauge	Length	Replaces	Unit Pkg.
12627	18	9"	Chry: 3843392 & other 18 Ga. links	5
12628	16	9"	GM: 6292996, 8903489 Ford D3AZ-14526-E & other 16 Ga. links	5
12629	14	9"	GM: 6292995, 8903488 Ford D3AZ-14526D & other 14 Ga. links	5
17465	12	9"	GM: 6293923	5
17464	10	9"	GM: 12077140	5

Test Clips



Type 1



Type 2

Auveco Part No.	Type	Description	Unit Pkg.
20478	1	10 Amp, Alligator Clip, Nickel Plated, 2" Long	5
16969	2	10 Amp, Red Insulation, 2-1/4" Long	5
16970	2	10 Amp, Black Insulation, 2-1/4" Long	5
16971	2	1 Each of 16969 & 16970	1 Pair
16972	2	30 Amp, Red Insulation, 3" Long	5
16973	2	30 Amp, Black Insulation, 3" Long	5
16974	2	1 Each of 16972 & 16973	1 Pair
16975	2	50 Amp, Red Insulation, 3" Long	5
16976	2	50 Amp, Black Insulation, 3" Long	5
16977	2	1 Each of 16975 & 16976	1 Pair

BATTERY CABLE & TERMINALS
Battery Cable



Auveco Part No.	Gauge	Stranding	O.D.	Unit Pkg.
11392	4	70 x 22.5	.380	25' Roll
13850	1/0	133 x 21	.530	25' Roll
13851	2/0	133 x 20	.590	25' Roll

Bare Copper Standard Conductor, covered with tough black Polyvinyl Chloride insulation. The thick jacket is easy to strip, resistant to moisture, weather, oil and acids.



Solderless Battery Cable Terminals
Tin Plated Copper

Auveco Part No.	Cable Size	Post Size	Unit Pkg.
-----------------	------------	-----------	-----------

11360	No. 6 AWG	Universal	2
11361	No. 4 AWG	Universal	2
11362	No. 1 AWG	Positive	2
11363	No. 1 AWG	Negative	2
11364	No. 1/0 AWG	Positive	2
11365	No. 1/0 AWG	Negative	2
11366	No. 2/0 AWG	Positive	2
11367	No. 2/0 AWG	Negative	2
15858	No. 3/0 AWG	Positive	2

Note: Use w/ Auveco Tool No. 7996

Engine Ground & Bonding Strap



19499

Replacement for body to engine block straps. Solves light dimming problems by grounding charging system. Also reduces radio noise. Copper braided wire with tin-plated brass ring terminals. 8" long. 10 Gauge. 5/16" - 3/8" stud size ring terminal.

UNIT PACKAGE: 2

Universal Battery Terminal

9948

For Positive & Negative Posts
Cable Range 8 thru 2/0 AWG

UNIT PACKAGE: 2



Universal Side Mount Battery Cable Terminal

12975

Fits all small diameter cables - both positive and negative.

UNIT PACKAGE: 2

Marine Battery Terminals

Lead Plated Brass Terminal
Nickel Plated Grade 2 Steel Wing Nut
Zinc Plated Grade 2 Steel Bolt & Nut



8772
For Positive Posts
3/8"-16 Stud

UNIT PACKAGE: 5

8773
For Negative Posts
5/16"-18 Stud

UNIT PACKAGE: 5

All Lead Terminal



Universal Positive & Negative

10808

Zinc Plated Steel Bolt & Nuts
5/16"-18 Stud

UNIT PACKAGE: 2

COMPRESSION BATTERY CABLE TERMINALS **Sec. 12**

All clamps and lugs are made of cast copper • All clamps, lugs and fasteners are tin plated

Assemble with common hand tools.

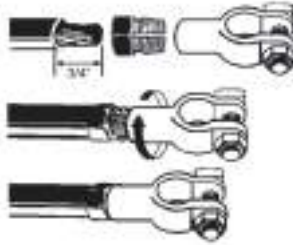

Three Easy Steps

1. Strip 3/4" of insulation from the end of the cable. Insert bared wire into the compression nut.
2. Thread terminal on compression nut.
3. Grip compression nut with wrench and turn the terminal until the compression nut seats. With larger gauges you may want to hold the terminal in a vise.

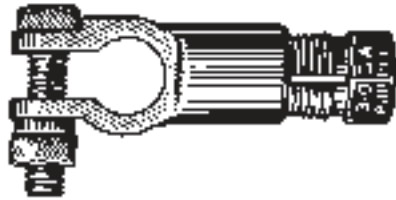

Straight Clamp

Auveco Cable Part No. Gauge	Desc.	Color	Unit Pkg.
156034	Pos.	Gray	2
156051&2	Pos.	Green	2
156061/0	Neg.	Black	2
156071/0	Pos.	Black	2
156082/0	Neg.	Orange	2
156092/0	Pos.	Orange	2
156103/0	Neg.	Purple	2
156113/0	Pos.	Purple	2

Flag Clamp

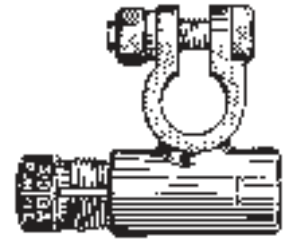

Auveco Cable Part No. Gauge	Desc.	Color	Unit Pkg.
156131/0	Pos.	Black	2
156152/0	Pos.	Orange	2



Stud/Side Terminal

Auveco Part No.	Cable Gauge	Color	Unit Pkg.
15628	1/0	Black	2



Heavy Wall Copper Lug

Auveco Cable Part No. Gauge	Hole Size	Color	Unit Pkg.
156184	3/8"	Gray	2
156191&2	3/8"	Green	2
156201/0	3/8"	Black	2
156211/0	1/2"	Black	2
156222/0	3/8"	Orange	2
156243/0	3/8"	Purple	2
156253/0	1/2"	Purple	2

Compression Nut



Auveco Part No.	Cable Gauge	Color	Unit Pkg.
15632	2/0	Orange	5

Sec. 12

BATTERY TERMINALS



Copper Battery Cable Lugs

Auveco Part No.	Cable Size	Stud Size	Unit Pkg.
5794	4 Ga.	3/8"	25
5796	1/0 Ga.	3/8"	25
11467	2/0 Ga.	1/2"	10

Use Auveco No. 7996 Crimping Tool



Butt Connector (Double Flared)

Pure Copper with Tin Plating

Applications: Field or shop splicing of battery cables and welding cables.

Auveco Part No.	Cable Size	Length	Unit Pkg.
11729	2/0 Ga.	1-3/4"	5



Battery Side Terminal Bolt

11083

(8917444)

Zinc

Thread Size 3/8-16
Overall Length: 1-1/8"
GM

UNIT PACKAGE: 10



19199

(12004188)

Zinc

Battery Side Terminal Bolt
Thread Size: 3/8"-16
Overall Length: 1-3/4"
GM

UNIT PACKAGE: 5



13816

Battery Hold Down Nuts
3/8-16

18/8 Stainless Steel

UNIT PACKAGE: 4



Battery Terminal Bolt & Nut

Zinc Chromate

Auveco Part No.	Size	Unit Pkg.
3186	5/16"-18 x 1-1/4"	Bolt W/Collared Nut.....100
8003	5/16"-18 x 1-1/4"	Bolt W/Hex Nut.....50
8870	5/16"-18 x 1-1/2"	Bolt W/Collared Nut.....100
14974	5/16"-18 x 1-1/4"	Bolt Only.....50
14975	5/16"-18	Collared Nut Only.....50

BATTERY TERMINALS

Heavy Duty Battery Cable Terminal Ends For Stud-Type Batteries
For Auto, Truck, Marine and H.D. Equipment



Single Barrel

3/8 Stud Size
Copper/Plated

Auveco Part No.	Cable Size	Unit Pkg.
13810	1/0	2
13811	2/0	2



Double Barrel

3/8 Stud Size
Copper/Plated

Auveco Part No.	Cable Size	Unit Pkg.
13814	2/0	1

Cable Terminal End Kit

13817

1/0 Cable Size



Contains the following:

- 2 crimpable, copper terminals (Auveco No. 13810)
- 2 battery terminal nuts (Auveco No. 13816)
- 1 piece of red (+) heat-shrink tubing
- 1 piece of black (-) heat shrink tubing

UNIT PACKAGE: 1 Kit

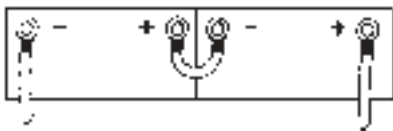

Suggested Terminal Assemblies

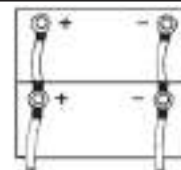
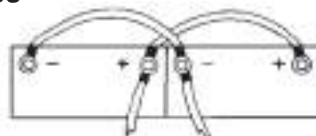

BATTERY TERMINAL TOOLS

Sec. 12



20899

Side Terminal Battery Cleaner

Coil spring cutters polish the battery contacts while the stainless steel brushes clean the cable terminals.

UNIT PACKAGE: 1



20898

Battery Brush

Cleans dirt and corrosion from post type battery terminals and cable clamps. Made of heavy duty stainless steel wire. Case is made of high impact plastic that will not weaken in cleaning solutions.

UNIT PACKAGE: 1

3-Way Battery Tool

13628



This tool cleans both posts and terminals. Tapered reamer assures correct angles on terminal clamps.

UNIT PACKAGE: 1



15039

Anti-Corrosion Protectant

A non-drying coating protectant, formulated especially for battery terminals and other exposed electrical connections.

UNIT PACKAGE: 1 Can (8 oz.)



7996

Use with vise or hammer
Crimps cable range
8 to 4/0 gauge

UNIT PACKAGE: 1

3M Vinyl Electrical Tape

Made In U.S.A.



.007" Thick x 3/4" Wide x 60 Ft. Long

16527 Unit Package: 5 Rolls

16578 Unit Package: 15 Rolls

General purpose vinyl insulating tape with excellent resistance to abrasion, moisture, alkalies, acid, copper corrosion and varying weather conditions. Can be used as a primary electrical insulation for all wire and cable splices rated up to 600 volts.

Linerless Self-Bonding Rubber Tape

Replace heat shrink tubing with a safe, tight, long-lasting seal that withstands temperature extremes from -50° to 300°F. No heat guns or open flames needed. No paper liner to mess with.



14389

3/4" x 15 Ft.
.030" Thick

UNIT PACKAGE: 1 Roll

It is stretched when applied and retains its elasticity to ensure a tight seal at all points. The tape is unaffected by salt spray and common automotive fluids. As long as it is stretched when it is applied, it will not unravel after application due to its self-bonding characteristics.

Made In The U.S.A.



Black Thin Wall Heat Shrink Tubing

- 2 To 1 Shrink Ratio
- Highly Flame Retardant (VW-1)
- Cross linked Polyolefin

Auveco Part No.	Pre-Shrink Size	Pre-Shrink I.D.	Post-Shrink I.D.	Post-Shrink Length	Unit Pkg.	Auveco Part No.	Pre-Shrink Size	Pre-Shrink I.D.	Post-Shrink I.D.	Post-Shrink Length	Unit Pkg.
18693	3/64"	.046"	.023"	.6"	25	18699	3/8"	.375"	.187"	6"	15
18694	1/16"	.063"	.031"	.6"	25	18700	1/2"	.500"	.250"	6"	15
18695	3/32"	.093"	.046"	.6"	25	18701	3/4"	.750"	.375"	6"	10
18696	1/8"	.125"	.062"	.6"	25	18702	1"	1.00"	.500"	6"	10
18697	3/16"	.187"	.093"	.6"	25	18703	1-1/2"	1.50"	.750"	6"	5
18698	1/4"	.250"	.125"	.6"	25	18704	2"	2.00"	1.00"	6"	5

Adhesive Lined Heat Shrink Tubing

- 4.5 To 1 Shrink Ratio
- Cross linked, Semi-Rigid Polyolefin Outer Jacket
- Hot-Melt Adhesive Inner Wall Adheres To All Major Types Of Wire
- Environmentally Seals & Insulates
- Meets O.E.M. Specs: Ford: ESB M99 D56 A1 Chrysler: MS-DB56

Auveco Part No.	Pre-Shrink I.D.	Post-Shrink I.D.	Length	Color	Unit Pkg.
18705	.225"	.050"	3-1/2"	Black	10
18706	.293"	.065"	3-1/2"	Black	10
18707	.427"	.095"	3-1/2"	Black	10
18708	.700"	.175"	3-1/2"	Black	5

Adhesive Lined Dual Wall Self-Sealing Heat Shrink Tubing

- 3 To 1 Shrink Ratio
- Provides Waterproofing & Environmental Protection
- Excellent Insulating, Abrasion-Resisting & Strain Relief Properties

Part No.	Size	I.D.	I.D.	Length	Color	Pkg.
16665	22-14 Ga.	.188"	.062"	12"	Black	4
16666	12-10 Ga.	.250"	.083"	12"	Black	4
18733	14-10 Ga.	.400"	.150"	6"	Black	4
19102	14-10 Ga.	.400"	.150"	6"	Black	25
18734	14-10 Ga.	.400"	.150"	6"	Red	4
19103	14-10 Ga.	.400"	.150"	6"	Red	25
18735	8-1 Ga.	.750"	.220"	6"	Black	4
19104	8-1 Ga.	.750"	.220"	6"	Black	25
18736	8-1 Ga.	.750"	.220"	6"	Red	4
19105	8-1 Ga.	.750"	.220"	6"	Red	25
18737	2-4/0 Ga.	1.100"	.375"	6"	Black	4
19106	2-4/0 Ga.	1.100"	.375"	6"	Black	25
18738	2-4/0 Ga.	1.100"	.375"	6"	Red	4
19107	2-4/0 Ga.	1.100"	.375"	6"	Red	25

Part No. 18887

Six inch lengths of black thin wall, cross linked polyolefin, heat shrink tubing in a durable translucent polypropylene box. The tubing has 2:1 shrink ratio.



Part No.	Qty.	Size	Pre-Shrink I.D.	Post-Shrink I.D.
18697	36	3/16"	.187"	.093"
18698	24	1/4"	.250"	.125"
18699	12	3/8"	.375"	.187"
18700	6	1/2"	.500"	.250"
18701	4	3/4"	.750"	.375"
18702	4	1"	1.00"	.500"

UNIT PACKAGE: 1

Fuseholders And Accessories



12592
Nylon

Glass Tube Fusepuller

UNIT PACKAGE: 1



Not Actual Size

12079
Nylon

Moulded In-Line Fuse Holder with 8" of 18 Ga. Wire
Use with Auveco 1/4" x 1-1/4" Glass Tube Fuses up to and including 20 Amps.

UNIT PACKAGE: 3



Not Actual Size

11618
Nylon

Fuse Assembly
With 30 Amp Fuse Included
12 Gauge Wire

UNIT PACKAGE: 5



Not Actual Size

18103

Tests ATO (Blade Type) and Mini-Fuses. Now you can make sure the fuse is good before installing it. Also functions as a fuse puller. 40 Amp maximum

UNIT PACKAGE: 1



Not Actual Size

12359

In-Line Fuse Holder

Accommodates all ATO/ATC fuses from 3-30 Amps
Heavy Duty Hard Shell Construction
10" Loop of 14 Gauge Wire

UNIT PACKAGE: 3



14055

In-Line Fuse Holder

Accommodates all ATO/ATC fuses from 3-30 Amps
Heavy Duty Hard Shell Construction
10" Loop of 12 Ga. Wire

UNIT PACKAGE: 3



12363

In-Line Fuse Holder

Accommodates all ATO/ATC fuses from 3 thru 20 Amps.
Comes with two 4" 16 Ga. Wire Leads.

UNIT PACKAGE: 5



Not Actual Size

20789

In-Line Mini Fuse Fuseholder
30 Amp Maximum
12 Ga. Wire
Use With Auveco Mini Fuses
16351 - 16360

Replaces Auveco 17648
Fuse Not Included

UNIT PACKAGE: 3

Self-Stripping Fuseholder



12977

Mates with most plug-in blade type fuses found in late-model domestic and some import cars. For 18-14 gauge copper wire.

32 volts maximum.
20 amp maximum with 14 gauge wire.
10 amp maximum with 16 gauge wire.
7.5 amp maximum with 18 gauge wire.

UNIT PACKAGE: 5

Sec. 12

Sealed Fuse Holders For ATM Mini® Fuses

Not Actual Size



20206

20, 25 & 30 Amp Capacity
10" Long 12 Ga. Cross-Linked
Polyethylene Leads
Fuse Not Included

UNIT PACKAGE: 1

20207

2-15 Amp Capacity
10" Long
16 Ga. Cross-Linked
Polyethylene Leads
Fuse Not Included

UNIT PACKAGE: 1

High Power Sealed Fuse Holder



20320

For ATC & ATO Fuses
40 Amp Capacity
12" Long 10 Gauge 105 Strand
EZ Flex Wire Leads
Fuse Not Included

UNIT PACKAGE: 1

Environmentally Sealed Blade Type Fuse Holder

Also Used As Fuel Pump Fuseholder on GM Vehicles
(Fuse Not Included)



13686

(GM: 12101917; Delco: PT-189)

Unit Pkg: 1

Electrical system protection for fleets, construction equipment, aircraft service vehicles, outdoor power equipment and marine installations.

Resistant to moisture, salt spray and engine compartment fluids. Withstands 50 g physical shock. Operating temperature range from -40° to 125°C.

- Nylon Body with Latching Cap
- Silicone Rubber Seals at Wires and Cap
- 12 Gauge SE/GPT Wire Leads
- 3 to 30 Amp Capacity - Type ATC/ATO Fuses
- 5" Long Wire Leads



Type 1



Type 2



Type 3



Type 4

Auveco Part No.	Type	Amp Rating	Color	Unit Pkg.	Auveco Part No.	Type	Amp Rating	Color	Unit Pkg.
20560	1	20	Blue	1	15933	3	40	Green	1
15926	1	30	Pink	1	15934	3	70	Brown	1
15927	1	40	Green	1	19295	3	80	Black	2
19294	1	50	Red	3	19296	3	100	Blue	2
15928	1	60	Yellow	1	20551	4	20	Blue	2
15929	2	30	Pink	1	20552	4	30	Pink	2
15930	2	60	Yellow	1	20553	4	40	Green	2
15931	2	80	Black	1	20554	4	50	Red	2
15932	3	30	Pink	1	20555	4	60	Yellow	2

Low Profile J Case Fuses



Auveco Part No.	Amp Rating	Color	Unit Pkg.
21472	20	Blue	3
21473	25	White	3
21474	30	Pink	3
21106	40	Green	3
21475	50	Red	3
21476	60	Yellow	3

Fuse Blocks

For use with SFE-20 Amp. fuse or any 3 AG series fuse. Phosphor bronze fuse clips. Brass screws



13445
Four Gang Fuse Block
Size: 2-7/16" x 2-15/16" x 3/4"
UNIT PACKAGE: 1

Terminal/Junction Blocks

For marine and exposed applications. Brass nickel plated terminal links and binding head terminal screws. Moisture repellent molded ABS base with protective insulator barrier strips. 20 Amp rating.



13446
4 Gang (Circuits)
Size: 3-1/4" x 1-5/16" x 5/8"
UNIT PACKAGE: 1

13447
6 Gang (Circuits)
Size 3-3/8" x 1-1/8" x 9/16"
UNIT PACKAGE: 1

13449
10 Gang (Circuits)
Size: 5-1/8" x 1-1/8" x 9/16"
UNIT PACKAGE: 1

Fuses & Circuit Breakers

Sec. 12



ATC®/ATO® (Blade Type) Fuses

Auveco Part No.		Amp Rating	Color
Unit Pkg. 5	Unit Pkg. 25		
12534	12548	3	Violet
12535	12549	4	Pink
12536	12550	5	Tan
12537	12551	7-1/2	Brown
12538	12552	10	Red
12539	12553	15	Blue
12540	12554	20	Yellow
12541	12555	25	White
12542	12556	30	Green



Maxi™ Fuses

Auveco Part No.	Amp Rating	Color	Unit Pkg.
15505	20	Yellow	2
15506	30	Green	2
15507	40	Orange	2
15508	50	Red	2
15509	60	Blue	2



Low Profile Mini Fuses

Auveco Part No.	Amp Rating	Color	Unit Pkg.
21602	5	Tan	5
21603	7.5	Brown	5
21436	10	Red	5
21437	15	Blue	5
21166	20	Yellow	5
21438	25	Clear	5
21604	30	Green	5



Mega Fuses

Auveco Part No.	Amp Rating	Unit Pkg.
21598	40	2
21599	60	2
21600	80	2
18986	100	2
18987	125	2
18988	150	2
18989	175	2
18990	200	2
18991	225	2

Glass Tube Fuses



Auveco Part No.	Size	Amp	Code	Unit Pkg.
18981	1/4" x 1-1/4"	2	AGC-2	5
17625	1/4" x 1-1/4"	3	AGC-3	5
17626	1/4" x 1-1/4"	5	AGC-5	10
17627	1/4" x 1-1/4"	7.5	AGC-7.5	10
12545	1/4" x 1-1/4"	10	AGC-10	5
12546	1/4" x 1-1/4"	15	AGC-15	5
18982	1/4" x 1-1/4"	20	AGC-20	5
12543	1/4" x 1-1/4"	20	SFE-20	5
18983	1/4" x 1-1/4"	25	AGC-25	5
12544	1/4" x 1-7/16"	30	SFE-30	5
12547	1/4" x 1-1/4"	30	AGC-30	5



Mini Fuses

Auveco Part No.	Amp Rating	Color	Unit Pkg.
16351	2	Gray	5
16352	3	Purple	5
16353	4	Pink	5
16354	5	Tan	5
16355	7.5	Brown	5
16356	10	Red	5
16357	15	Blue	5
16358	20	Yellow	5
16359	25	White	5
16360	30	Green	5

Circuit Breakers

Automatic Re-Set



Auveco Part No.	Type	Specifications	Unit Pkg.
15046	1	30 Amps At 12 Volts	5
18518	2	10 Amps At 12 Volts	2
18519	2	15 Amps At 12 Volts	2
18520	2	20 Amps At 12 Volts	2
18521	2	30 Amps At 12 Volts	2
18522	2	40 Amps At 12 Volts	2
15047	3	20 Amps At 12 Volts	5
15048	3	30 Amps At 12 Volts	5
15049	3	40 Amps At 12 Volts	5

FUSE ACCESSORIES



A quick, easy alternative to direct wiring when tapping the "hot side" of the fuse block.

14474

Blade Type Fuse Tap

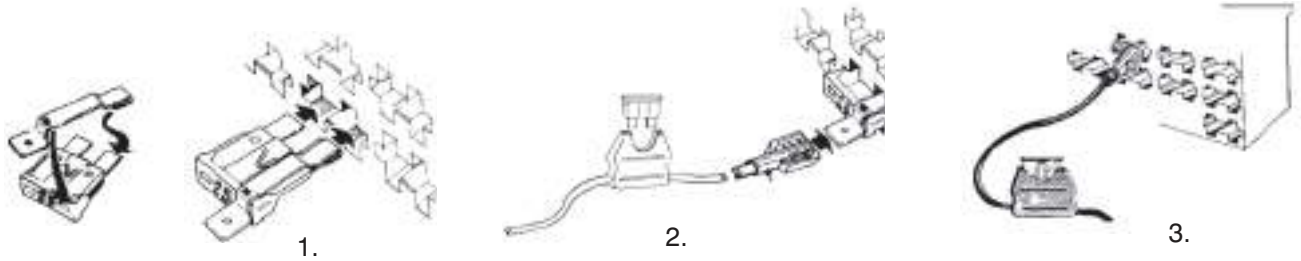

The blade type fuse tap is made of sturdy brass and is engineered for quick connect and disconnect of accessories such as C.B. radios, hand-held lights, etc. Installation can be completed in three steps.

1. Use a test probe to locate the "hot side" of the circuit in the fuseblock. Then snap the tap over the corresponding "hot side" blade of the fuse. Insert the fuse into the fuseblock.
2. Crimp one end of an in-line fuse holder (with the fuse installed) to a fully insulated nylon .250" female quick-connect terminal. Attach the other fuse holder lead to the accessory wire.
3. Complete the connection by sliding the female quick-connect terminal onto the protruding tab of the tap.

UNIT PACKAGE: 25

Mini Fuse Blade Type Fuse Tap

"Tapping" fuse blocks equipped with mini fuses are No Problem!



17686

Now there's a quick, easy alternative to direct wiring for tapping the "hot side" of mini fuse style fuse blocks. The blade type fuse tap is made of .016" thick sturdy brass with a .187" (3/16") wide tab. It is engineered for quick connect and disconnect of accessories.

Insert fuse blade into tap

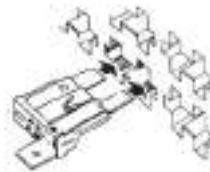

1. Locate "hot side" of circuit in the fuse block with a test probe. Slide the tap onto the corresponding "hot side" blade of the fuse.
2. Insert the fuse into the fuseblock
3. Crimp one end of an in-line fuse holder (with the fuse installed) to the appropriate Aueco female connector 8781 (16-14 ga.) or 12159 (22-18 ga.). Attach the other fuse holder lead to the accessory wire. Slide the female connector onto the protruding tab of the tap.

UNIT PACKAGE: 50

Sec. 12

GM SOCKET ASSY. & HARNESS CONNECTORS

Use with butt connectors on pages 139 - 147 • Illustrations Not Actual Size



9905

(Chrys: 2496279; GM: 2973932;
AMC: 3509575; IHC: 374985C1)

Instrument Panel Socket
for 5/8" Hole

Bulb No. 158, 194, 194A

GM, Chrysler, AMC & International

UNIT PACKAGE: 10



11166

(GM: 6294015, 8901283, 8918527;
Ford: D40Z-13410E, D7AZ-13412A,
D7FZ-13412A)

Side Marker & License Plate Lights

Bulb Nos. 158, 194, 194A
GM & Ford

UNIT PACKAGE: 1

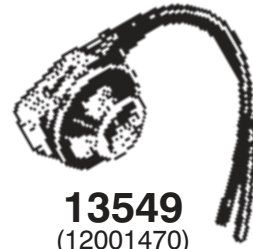

13549

(12001470)

Side Marker, License,
Tail & Stop Lights
Bulb Nos. 158, 194, 194A
GM

UNIT PACKAGE: 1



12237

(Chrys: 3744750; GM: 12004311,
25015169; Ford: C80Z-13711A)

Instrument Panel Socket
for 1/2" Hole

Bulb No. 158, 194, 194A

GM, Ford & Chrysler

UNIT PACKAGE: 2



13540

(8912750)

Side Marker, License,
Parking & Tail Lights
Bulb Nos. 158, 194, 194A
GM

UNIT PACKAGE: 1



13558

(6298892, 6298886)

Side Marker Assembly
Bulb Nos. 158, 194, 194A
GM

UNIT PACKAGE: 1



9883

(GM: 6298886, 6298892, 6298935;
Ford: D0DZ-15A434B)

Side Marker Assembly
Bulb Nos. 158, 194, 194A
GM & Ford

UNIT PACKAGE: 5



17108

(12083007)

Marker Light Pigtail
Bulb No. 24
GM 1988-On

UNIT PACKAGE: 1



8755

(2978302)

License Plate, Back-Up &
Instrument Panel Lights
Bulb Nos. 63, 67, 81, 87, 89, 93, 209,
1003, 1073, 1129, 1133 & 1141
For 1-1/8" Hole
GM

UNIT PACKAGE: 10



11441

Instrument Panel and Marker Lights
Bulb Nos. 158, 194, 194A
GM & Ford

UNIT PACKAGE: 10



18924

(12083460)

Rear Side Marker Lights
Bulb number 158, 194, 194A
GM 1985-On

UNIT PACKAGE: 1



8759

Signal, Park, Stop & Tail Lights
Bulb Nos. 198, 1016, 1034,
1154 & 1157
For 3/4" Hole
GM

UNIT PACKAGE: 5

GM SOCKET ASSY. & HARNESS CONNECTORS

Use with butt connectors on pages 139 - 147 • Illustrations Not Actual Size



8756
(2974309)

Signal, Park, Stop & Tail Lights
Bulb Nos. 198, 1016, 1034,
1154 & 1157
For 1-1/8" Hole
GM

UNIT PACKAGE: 10



11157
(AMC:
4486948;
GM: 2983540,
8912698;
6299087)

Signal, Park, Stop & Tail Lights
Bulb Nos. 1034, 1154 & 1157
GM & AMC

UNIT PACKAGE: 1

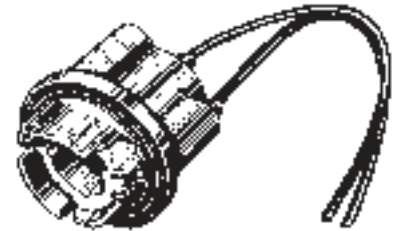

13544
(12003878, 8904251)

Back-up, Cornering & Turn Signal
Bulb No. 1156
GM

UNIT PACKAGE: 1

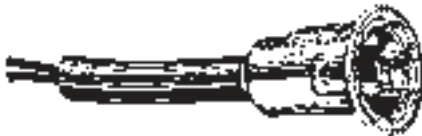

8754

Weatherproof Signal, Park,
Stop & Tail Lights
Bulb Nos. 198, 1016, 1034,
1154 & 1157
For 3/4" Hole
GM

UNIT PACKAGE: 5



11156
(GM: 5963268, 8904437,
8909518; IHC: 57172C91)

Back-up & Cornering
Bulb No. 1156
GM & IHC

UNIT PACKAGE: 1

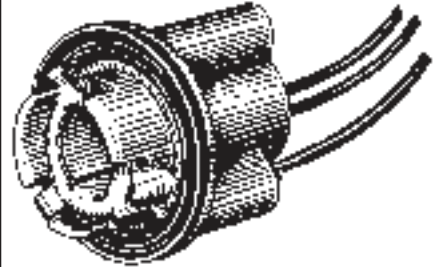

11446
(8902487, 8903283,
8907701 & 8909908)

Stop & Tail Lights
Bulb No. 1157
GM

UNIT PACKAGE: 5



8750
(2974309, 2983540,
6299087 & 8912698)

Signal, Park, Stop & Tail Lights
Bulb Nos. 1034, 1154 & 1157
GM

UNIT PACKAGE: 5

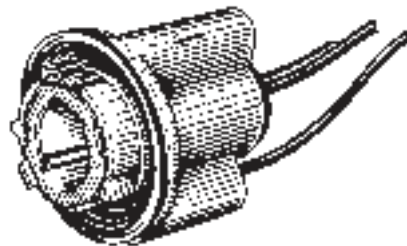

11476
(8903203, 8914823)

Park, Stop & Tail Lights
Bulb No. 1157
GM

UNIT PACKAGE: 5



11154
(8903202, 8914822)
Park, Stop & Tail Lights
Bulb Nos. 1034, 1154 & 1157
GM

UNIT PACKAGE: 1

Sec. 12

GM SOCKET ASSY. & HARNESS CONNECTORS

Use with butt connectors on pages 139 - 147 • Illustrations Not Actual Size



11475

(8903202, 8914822)

Park, Stop & Tail Lights
Bulb Nos. 1034, 1154 & 1157
GM

UNIT PACKAGE: 5



13543

(8919916,
12013813)

Park, Stop & Tail Lights
Bulb No. 1157
GM

UNIT PACKAGE: 1



18923

(12027133)

Back-Up Lights
GM 1982-On

UNIT PACKAGE: 1



21006

(15306157)
White Shell,
Natural Insert

Daytime Running Lights
& Turn Signal
Bulb Nos. 3156 & 4156
GM 1999 - On

UNIT PACKAGE: 1

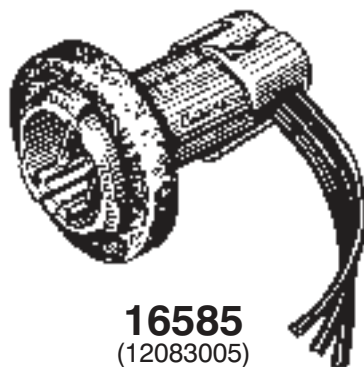

16585

(12083005)

Signal, Park, Stop & Tail Lights
Bulb No. 3057 Dual Filament
Wedge Base
GM

UNIT PACKAGE: 1

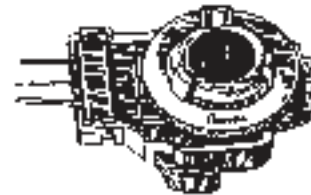

12600

(GM: 12003759; AMC: 812893)

90° Pigtail & Socket Assembly
Bulb Nos. 1016, 1034, 1154 & 1157
GM & AMC

UNIT PACKAGE: 1

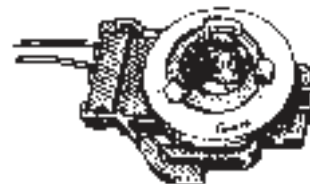

13545

(12003758)

Tail Lights
Single Contact
Bulb Nos. 87, 93 & 1156
GM

UNIT PACKAGE: 1

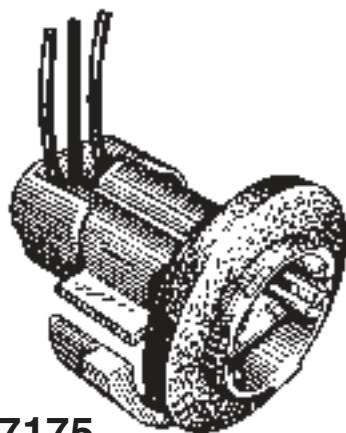

17175

(12076946)
Ivory Shell

Stop, Tail, Turn & Parking Lights
Bulb No. 3057 & 3157
GM 1988-On

UNIT PACKAGE: 1

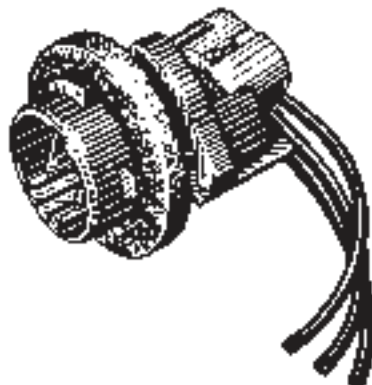

16586

(12083006)

Signal, Park, Stop & Tail Lights
Bulb No. 3057 Dual Filament
Wedge Base
GM

UNIT PACKAGE: 1

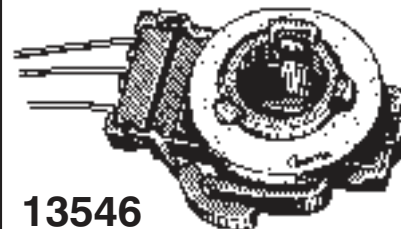

13546

(12003757)

Signal & Park Lights
Bulb Nos. 194, 198 & 2057
GM

UNIT PACKAGE: 1

GM SOCKET ASSY. & HARNESS CONNECTORS

Use with butt connectors on pages 139 - 147 • Illustrations Not Actual Size

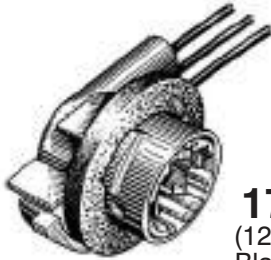

17172
(12083680)
Black Shell

Stop, Tail, Turn & Parking Lights
Bulb No. 3057 & 3157
GM: 1989-On

UNIT PACKAGE: 1

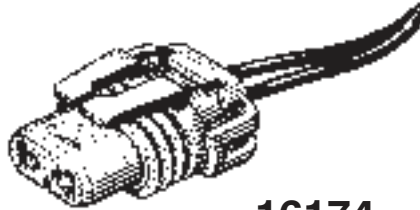

16174
(GM: 12101897)

Headlight Socket Assembly
For Low Beam 9006 Halogen Bulb
Single Indexing Groove
GM, Ford, AMC & Imports

UNIT PACKAGE: 4



17112
Not Supplied By O.E.M.

Distributor Module Pigtail
Used on GM distributor module
1987466 on 6 cylinder 2.8 engines
1985-On

UNIT PACKAGE: 1



17173
(12083689)
Ivory Shell

Stop, Tail, Turn & Parking Lights
Bulb No. 3057 & 3157
GM 1990-On

UNIT PACKAGE: 1

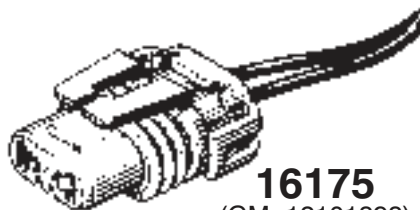

16175
(GM: 12101898)

Headlight Socket Assembly
For High Beam 9005, H10 & H12
Halogen Bulbs
Two Indexing Grooves
GM, Ford, AMC & Imports

UNIT PACKAGE: 4



18916
(12085483)

Ignition Module,
Crankshaft Coolant Sensor &
Power Steering Pressure Switch
Harness Connector
GM 1986-On

UNIT PACKAGE: 1



17174
(12085330)
Brown Shell

Back-Up Lights
Bulb No. 2456 & 3156
GM 1990-On

UNIT PACKAGE: 1

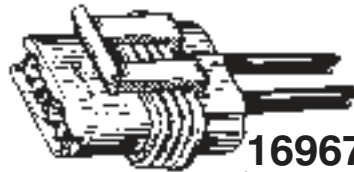

16967
(12101906)

Heater Blower connector pigtail on
GM 1985-On. Can also be used as
an ATO/ATC Fuse Holder.
Features two 9" long 12 gauge
GXL wire leads.

UNIT PACKAGE: 1



18870
(12101855)

Direct Ignition
Vehicle Speed Sensor
Harness Connector
GM
1987-On

UNIT PACKAGE: 1



14918
(12048369)

Headlight Socket Assembly For
High-Low 9004 & 9007 Halogen Bulb
GM, Ford & Imports

UNIT PACKAGE: 1

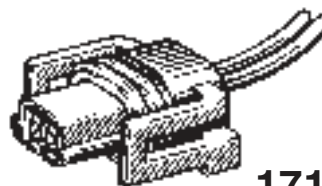

17114
(12085496)

Direct Ignition Throttle
Body Injection Pigtail
GM 1987-On

UNIT PACKAGE: 2



18867
(12101880)

Direct Ignition
Harness Connector
GM
1987-On

UNIT PACKAGE: 1

Sec. 12 GM SOCKET ASSY. & HARNESS CONNECTORS

Use with butt connectors on pages 139 - 147 • Illustrations Not Actual Size



18318
(12101857)

Air Divert Valve
Harness Connector
GM 1994-87

UNIT PACKAGE: 1

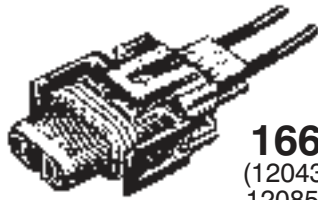

16694
(12043215,
12085498)

Cornering & Fog Light Socket
For 881 & H1 Halogen Bulbs
GM

UNIT PACKAGE: 1



21212
(88988609)

Window Motor Regulator
Harness Connector
Two 12 Gauge
10" Long Leads
GM 1995 - On

UNIT PACKAGE: 1



18320
(12101856)

Air Switch Valve
Harness Connector
GM 1993-91

UNIT PACKAGE: 1



21490
(GM: 12102664, 88862264)
(Ford: 1U2Z-14S411-YA)

Fog & Front Lights,
Pwr. Steering & Oil Pressure Switch
Harness Connector
GM 2005 - 1986
Ford 2004 - 1995
Jeep Eagle 1994

UNIT PACKAGE: 1



16693
(12046624,
12102620)

Replacement harness connector
used with 1985-on GM Manifold Air
Temperature Sensors including
25036751. Features two 9" long 18
gauge wire leads.

UNIT PACKAGE: 1



18524
(12085497)

MAP Mass Air Flow Sensor
Harness Connector
GM w/2.8 Eng &
Sequential Fuel Injection
1989-85

UNIT PACKAGE: 1

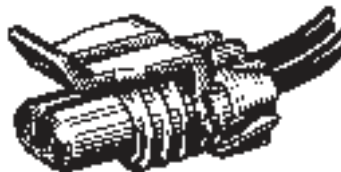

17110
(12102747)

Windshield Washer Pump, Low
Coolant Sensor Harness Connector
GM Cars & Trucks 1992-87

UNIT PACKAGE: 1



18917
(12085538)

Camshaft Sensor
Harness Connector
Buick, Olds & Pontiac
1992-86

UNIT PACKAGE: 1



18868
(12085495)

Mass Air Flow Sensor
Harness Connector
GM
1988-On

UNIT PACKAGE: 1



17111
(12116958)

Horn Harness Connector
Fits Horns 1999160, 1999161,
10456327 and 10456328
GM 1988-On

UNIT PACKAGE: 1

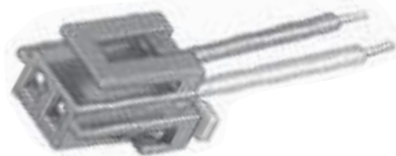

18925
(25117765)

E.F.I. Fuel Pump
Harness Connector
GM w/ Fuel Pump
In Gas Tank 1995-88

UNIT PACKAGE: 1

GM SOCKET ASSY. & HARNESS CONNECTORS

Use with butt connectors on pages 139 - 147 • Illustrations Not Actual Size



19891
(Not Available From O.E.M.)
Windshield Wiper Motor
Harness Connector
GM 1994 - 86
UNIT PACKAGE: 1

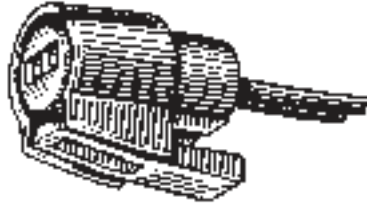

16513
(GM: 12085521)
Replacement harness connector
used on GM V-5 Air Conditioning
Switches. Fits GM High Pressure
Switch 6551917 and others. Index
slot is at the one o'clock position.
Features two 9" long 18 gauge
wire leads.
UNIT PACKAGE: 1

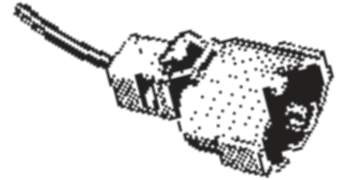

14580
(12102621)
Radiator Fan Sensor Switch
Harness Connector
Fits electric cooling fan switches
3040674, 14043275 and 14043276.
GM 1980-On
UNIT PACKAGE: 1

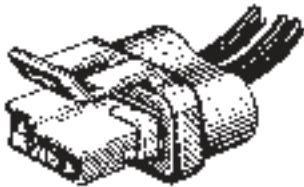

17109
(12085525, 12085527, 12085528,
12101895, 12117361)
3 Wire Alternator Harness Connector
Two 18 gauge and one 12 gauge
leads. Can be used to replace two
wire and single wire harness
connectors by taping
(Do Not Cut) the appropriate
unused leads.
GM 1986-On
UNIT PACKAGE: 1

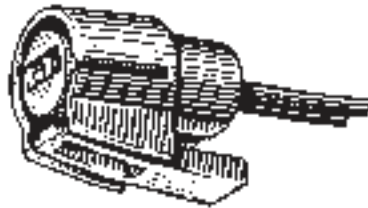

16514
(12085503)
Replacement harness connector
used on GM V-5 Air Conditioning
Compressor Pressure Cut-off
Switches. Fits GM low Pressure
Switch 6551946 and others
Index slot is at three o'clock position
Features two 9" long 18 gauge
wire leads
UNIT PACKAGE: 1



18674
(12126451)
Coolant Temperature
Sensor Harness Connector
Fits Sensor 10232601
& 25037203
GM 1987-On
UNIT PACKAGE: 1



21220
(GM: 88987187)
Headlight Socket Harness Connector
For H9 Halogen Bulb
(Auveco No. 21222 & BH9)
GM, Audi, Mazda,
Mini-Cooper, Porsche,
Volkswagen & Volvo
UNIT PACKAGE: 1

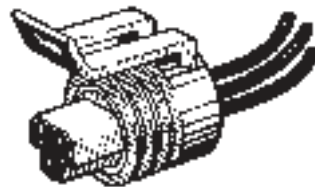

18527
(12102748)
Throttle Position Sensor
Harness Connector
GM 1994-90
UNIT PACKAGE: 1

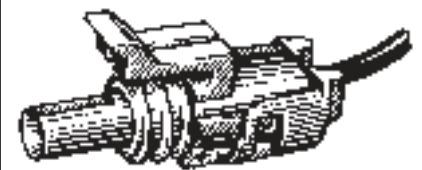

17107
(12117385)
Oxygen Sensor Connector Pigtail
Fits The Following Oxygen Sensors
8990469 (AC-Delco AFS13P)
8990625 (AC-Delco AFS15P)
8990741 (AC-Delco AFS16P)
10042186 (AC-Delco 213-15)
25105107 (AC-Delco AFS20)
25105901 (AC-Delco AFS21)
25106073 (AC-Delco AFS22)
Most GM Models 1982-On
UNIT PACKAGE: 1

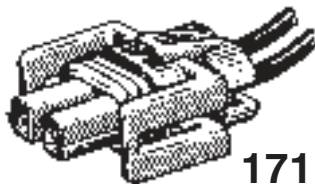

17113
(12101937)
A.C. Compressor
Clutch Harness Connector
GM Cars & APV 1989-On
UNIT PACKAGE: 1

Sec. 12

GM SOCKET ASSY. & HARNESS CONNECTORS

Use with butt connectors on pages 139 - 147 • Illustrations Not Actual Size

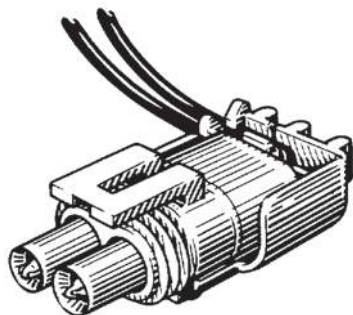

16962

(Not Supplied By O.E.M.)

Harness Connector used with GM Mixture Control Solenoid Kits 17067343, 17067344 and 17111102 on 2 & 4 barrel Rochester Varajet Carburetors. For GM cars and trucks 1980-On

UNIT PACKAGE: 1



17198

(Not Supplied By O.E.M.)

Throttle Position Sensor Harness Connector
Fits Sensor 17078051, 17078448 & 17078481 On 2 & 4 Barrel Rochester Carburetors GM 1990-80

UNIT PACKAGE: 1

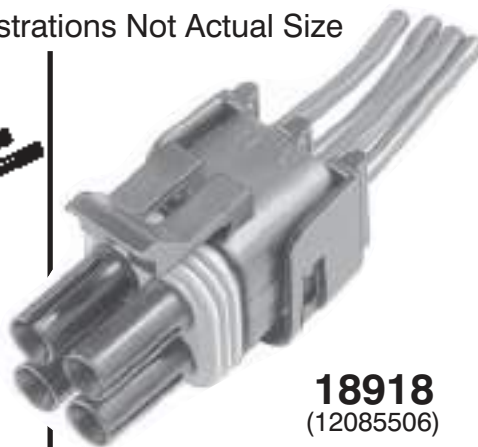

18918

(12085506)

Fuel Injection Idle Air Control Valve, Stoplight Switch & Torque Converter Clutch Valve Harness Connector GM 1985-On

UNIT PACKAGE: 1



19882

(12085485)

Back-Up Light Switch & Speed Sensor Harness Connector
Used With Switch 23049569, PT107 & IACV Motor GM 1971-On

UNIT PACKAGE: 1

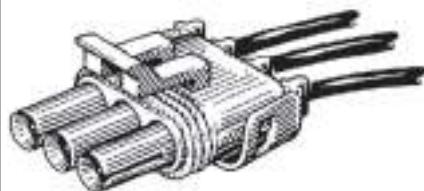

16964

(12085502)
Green

Manifold Absolute Pressure (MAP) Harness Connector. Fits GM MAP Sensor 16137039 on GM vehicles (38 models) 1982-on

UNIT PACKAGE: 1

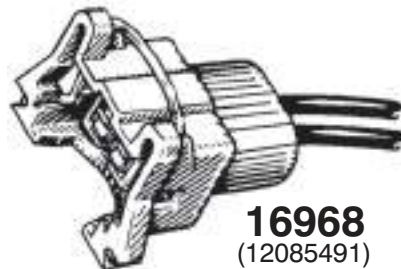

16968

(12085491)

Fuel Injector Solenoid Harness Connector.
Fits GM Multi-Port Fuel Injector 1711799 on 2.8 and 3.1 liter engines (27 models) 1986-On
Also fits Fuel Injectors on Ford, Chrysler & Imports (Bosch)

UNIT PACKAGE: 1



16965

(12085507)
Gray

Air Conditioner Pressure Switch Harness Connector
Used on GM vehicles (28 models) 1988-84

UNIT PACKAGE: 1

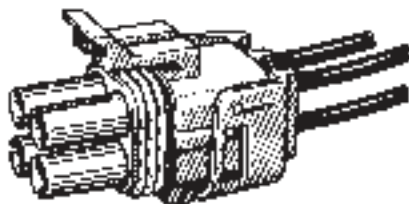

17199

(12085533)

Transmission Converter Clutch Harness Connector
3 Wires (Cavity "C" is Not Wired) GM 1990-84

UNIT PACKAGE: 1

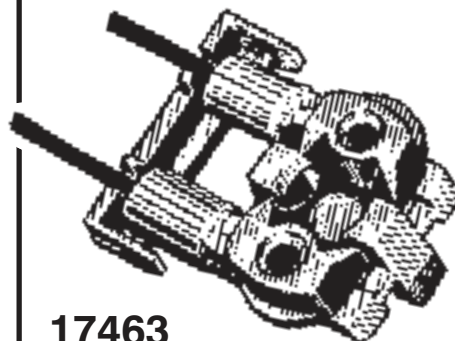

17463

(12102568)

Fuel Injector Connector For TBI (Throttle Body Injector) Systems All GM (Including Trucks) 1978-On

UNIT PACKAGE: 1

GM SOCKET ASSY. & HARNESS CONNECTORS

Use with butt connectors on pages 139 - 147 • Illustrations Not Actual Size

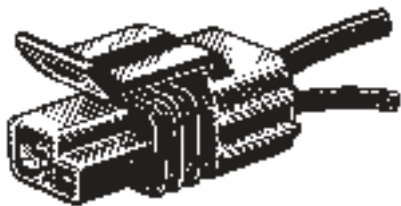

18316
(12101933)

Ignition Coil
Harness Connector
GM 1995-87

UNIT PACKAGE: 1



18872
(12085487)

Windshield Wiper Motor
Harness Connector
GM
1984-On

UNIT PACKAGE: 1



11444

Voltage Regulator Pigtail
GM

UNIT PACKAGE: 10

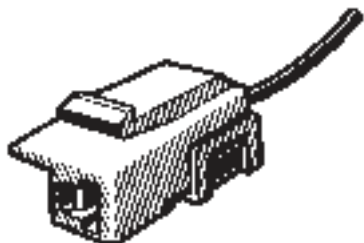

18526
(12117353)

Fuel Pump, Instrument Panel &
General Purpose
Harness Connector
GM 1995-90

UNIT PACKAGE: 2



19556
(12117354)

Harness Connector
Brake Light Switch 25529862
GM: Camaro, Caprice, Century,
Firebird, Lumina APV, K,S,
& T Truck, Silhouette
& Trans Sport 1991-On

UNIT PACKAGE: 1



21033
(88953358)

Harness Connector
For Blower Motor Resistors
89019088, 89019089 &
89019100 and Various Relays,
Switches & Actuators
8" Leads
GM Cars and Light &
Medium Duty Trucks
1990 - On

UNIT PACKAGE: 1

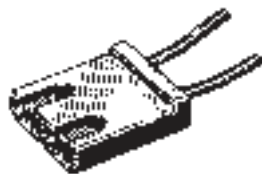

17690
(12101903)

Washer Fluid Sensor
Harness Connector
Also Used On Back-Up
Light Switch & A.C.
Compressor Switch
GM 1985-On

UNIT PACKAGE: 5

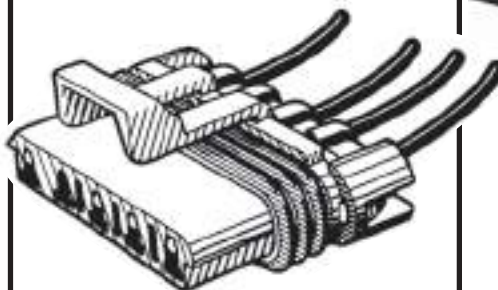

18525
(Not Supplied
By O.E.M.)

Tail Light Harness Connector
GM Full Size Pick-Up Trucks
1995-88

UNIT PACKAGE: 1



21542
(GM: 88953358)

Harness Connector
With Seven 12 Ga. 12" Leads
For Blower Motor Resistors
89019088, 89019089 &
89019100 and Various Relays,
Switches & Actuators
GM Cars and Light & Medium Duty
Trucks
1990 - On

UNIT PACKAGE: 1

Sec. 12

GM SOCKET ASSY. & HARNESS CONNECTORS

Use with butt connectors on pages 139 - 147 • Illustrations Not Actual Size



19554
(12101927)

Harness Connector
Headlight and Ignition
Switches 15693540, 10471139,
1070881, 26693547 & 15693548
GM: Astro, Safari, C, K,
S, T Trucks, Kodiak &
Grand Am 1990-On

UNIT PACKAGE: 1



17691
(12101909)

Alternator Harness Connector
Two 16 Ga. Leads
Fits Delcotron Models 10-SI, 12-SI,
15-SI & 27-SI With
Internal Voltage Regulator
GM 1980-71

UNIT PACKAGE: 5

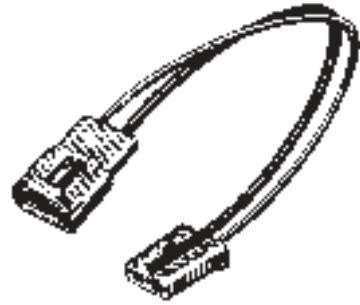

13548
(6294493)

Alternator Extendor
Harness Connector With
Female Connector
GM
1971-On

UNIT PACKAGE: 2

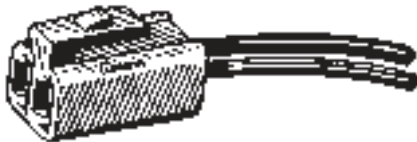

11442
(2977373)

Alternator Harness Connector
w/External Voltage Regulators
GM 1977-62

UNIT PACKAGE: 10

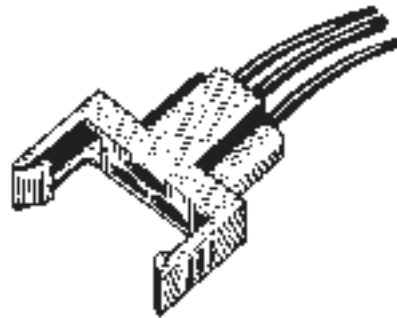

11436

Dimmer Switch
Harness Connector
GM

UNIT PACKAGE: 10

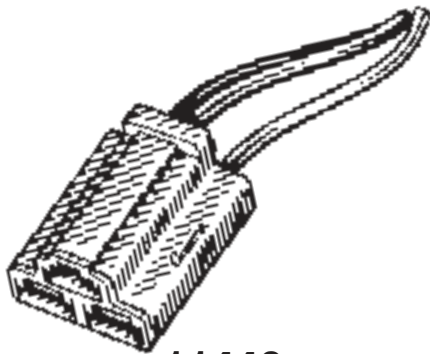

11440
(GM: 2962510)

Air Conditioner Blower Relay
Harness Connector
18 Ga. Wire
GM, AMC & Chrysler

UNIT PACKAGE: 10

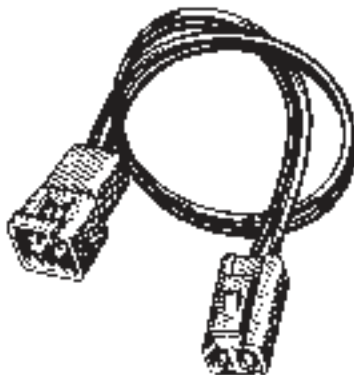

13547
(2977373)

Alternator Extendor
Harness Connector With
Female Connector
GM 1974-62

UNIT PACKAGE: 2



11443
(6294493)

Alternator Harness Connector
w/Transistorized Alternators
GM

UNIT PACKAGE: 10



19555
(12102757)

Harness Connector
Headlight Dimmer Switch
GM Most Models 1990-On

UNIT PACKAGE: 1

GM SOCKET ASSY. & HARNESS CONNECTORS

Use with butt connectors on pages 139 - 147 • Illustrations Not Actual Size



18871
(12101939)

Harness Connector For
Cooling Fan, Fuel Pump,
Starter Interrupt Relay &
Fan Control Switch
Cadillac
1988-On

UNIT PACKAGE: 1

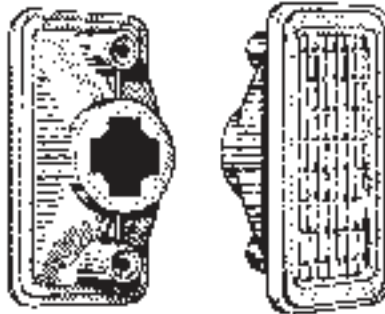

9884
(916638, 916581)
Plastic

Amber Lens
Front Fender Marker Lamp Assembly
Use w/Auveco No. 9883
GM

UNIT PACKAGE: 1

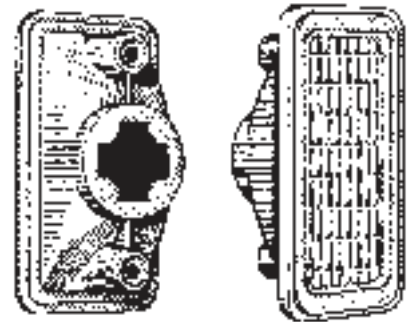

9916
(916632)
Plastic

Red Lens
Rear Quarter Marker
Lamp Assembly
Use w/Auveco 9883
GM

UNIT PACKAGE: 1

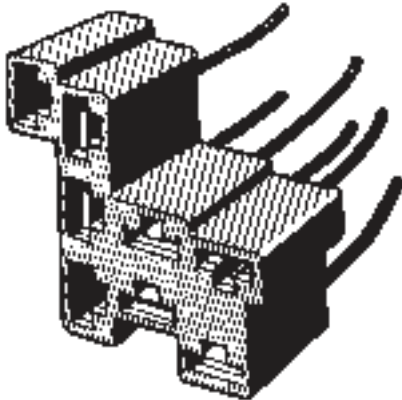

18530
(Not Supplied
By O.E.M)

Headlight Switch
Harness Connector
Fits Switch 1995217
GM 1991-68

UNIT PACKAGE: 1

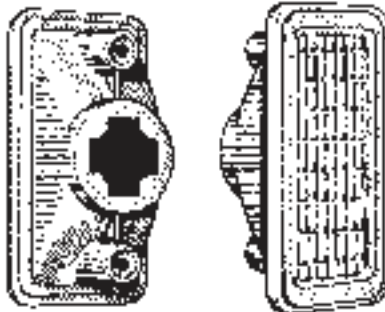

9885
(916638, 916581)
Plastic

Clear Lens
Front Fender Marker
Lamp Assembly
Use w/Auveco No. 9883
GM

UNIT PACKAGE: 1

**Inquire About Our
FasTrack Web Cost
Recovery Program
For Body Shops**

**Never Lose Money
On Fasteners
Again!**

Sec. 12

FORD SOCKET ASSY. & HARNESS CONNECTORS

Use with butt connectors on pages 139 - 147 • Illustrations Not Actual Size



12237

(Chrys: 3744750; GM: 12004311, 25015169; Ford: C80Z-13711A)

Instrument Panel Socket
For 1/2" Hole
Bulb No. 194
GM, Ford & Chrysler

UNIT PACKAGE: 2



11166

(GM: 6294015, 8901283, 8918527;
Ford: D40Z-13410E, D7AZ-13412A,
D7FZ-13412A)

Side Marker & License Plate Lights
Bulb Nos. 158, 194, 194A
GM & Ford

UNIT PACKAGE: 1

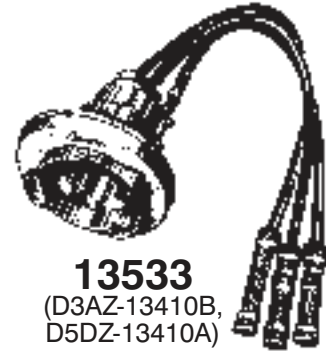

13533

(D3AZ-13410B,
D5DZ-13410A)

Rear Lights
Bulb No. 1157
Ford

UNIT PACKAGE: 1



9883

(GM: 6298886, 6298892, 6298935;
Ford: D0DZ-15A434B)

Side Marker Assembly
Bulb Nos. 158, 194, 194A
GM & Ford

UNIT PACKAGE: 5



8761

License Plate & Instrument
Panel Lights
Bulb Nos. 51, 53, 55, 57 & 57X
For 5/8" Hole
Ford

UNIT PACKAGE: 10



13535

(D3AZ-13410A)

Signal, Stop & Tail Lights
Bulb No. 1156
Ford

UNIT PACKAGE: 1



11441

Instrument Panel and Marker Lights
Bulb Nos. 158, 194, 194A
GM & Ford

UNIT PACKAGE: 10



13537

(D1AZ-13410B)

Stop & Tail Lights
With One Ground Male
Blade Terminal
Bulb Nos. 1034, 1154 & 1157
Ford

UNIT PACKAGE: 1

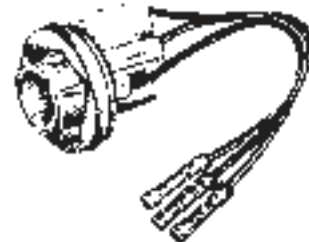

14133

(D4LY-13410-A)

Tail & Stop Lights
Bulb No. 1157
Ford

UNIT PACKAGE: 1

FORD SOCKET ASSY. & HARNESS CONNECTORS

Use with butt connectors on pages 137 - 149 • Illustrations Not Actual Size



14131
(D3AZ-13410-E)

Back-up/Cornering Lights
Bulb No. 1141
Ford

UNIT PACKAGE: 1

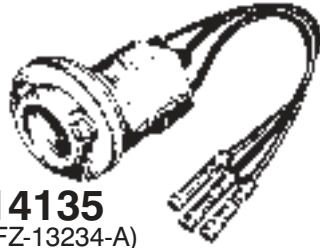

14135
(D1FZ-13234-A)

Parking Lights
Bulb No. 1157
Ford

UNIT PACKAGE: 1



21210
(Not Available From O.E.M.)

Universal Headlight Harness
Connector For H7 Halogen
Bulbs; Two 18 Gauge 6"
Long Leads; Ford, Audi, BMW,
Hyundai, Kia, Mazda, Mercedes, Mini
Cooper, Saab & Subaru

UNIT PACKAGE: 1



14130
(D4ZZ-13234-A)

Signal & Parking Lights
Bulb No. 1157
Ford

UNIT PACKAGE: 1

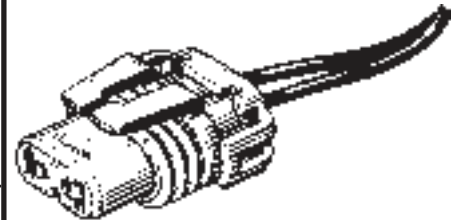

16174

Headlight Socket Assembly
For Low Beam 9006 Halogen Bulb
Single Indexing Groove
GM, Ford, AMC & Imports

UNIT PACKAGE: 4

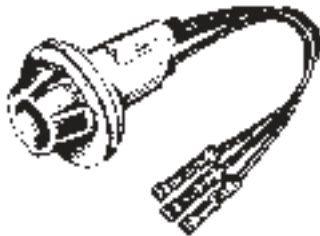

14128
(D4OZ-13234-A)

Signal & Parking Lights
Bulb No. 1157
Ford

UNIT PACKAGE: 1



20837

(Not Supplied By
O.E.M.)

Stop & Tail Light
Three 20 Ga. Wire Leads
Uses 2458, 3057 & 3157
Wedge Type Bulbs
Ford 1987 - On

UNIT PACKAGE: 1

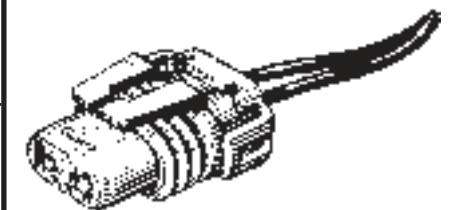

16175

Headlight Socket Assembly
For High Beam 9005 Halogen Bulb
Two Indexing Grooves
GM, Ford, AMC & Imports

UNIT PACKAGE: 4

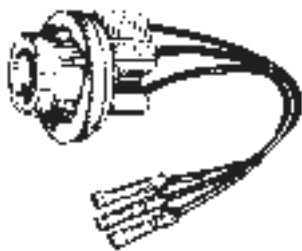

14132
(D3AZ-13410-G)

Tail & Stop lights
Bulb No. 1157
Ford

UNIT PACKAGE: 1



20848

(Not Supplied By
O.E.M.)

Rear Light Assembly
Harness Connector
Four 18 Ga. Wire Leads
Ford F250 Thru F750
Without Pick Up Box
1999 - On

UNIT PACKAGE: 1

Sec. 12

FORD SOCKET ASSY. & HARNESS CONNECTORS

Use with butt connectors on pages 137 - 149 • Illustrations Not Actual Size



21490

(GM: 12102664, 88862264)
(Ford: 1U2Z-14S411-YA)

Fog & Front Lights,
Pwr. Steering & Oil Pressure
Switch Harness Connector
GM 2005 - 1986
Ford 2004 - 1995
Jeep Eagle 1994

UNIT PACKAGE: 1



19890

(Not Available From O.E.M.)

Back-Up Light Switch
Harness Connector
Fits Switches C9TZ-15520C &
SW-849
Ford Trucks & T-Bird
1967-On

UNIT PACKAGE: 1

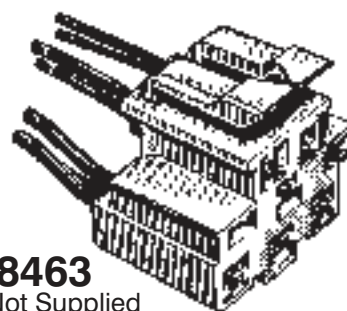

18463

(Not Supplied
By O.E.M.)

Headlight Switch
Harness Connector
Fits Headlight Switches
E6DZ-11654A & F2DZ-11654A
Ford Taurus & Mercury Sable
With Rotary Knob
1994-86

UNIT PACKAGE: 1



14918

(12048369)

Headlight Socket Assembly For
High-Low 9004 & 9007 Halogen Bulb
GM, Ford & Imports

UNIT PACKAGE: 1



19125

(Not Supplied
By O.E.M.)

Plugs Into Light Socket
Base For Double Filament
Wedge Type Bulbs
Stop, Tail, Turn & Parking Lights
Ford Ranger, Explorer & Econoline
1991-On

UNIT PACKAGE: 1

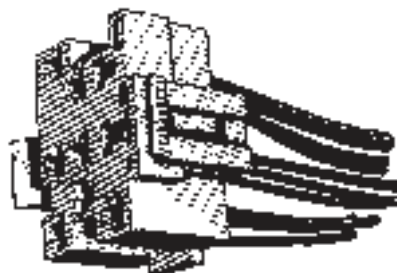

17624

(Not Supplied
By O.E.M.)

Headlight Switch Assembly
Harness Connector
Fits Instrument Panel
Headlight Switch E7TZ-11654-C
Ford Trucks: F150, F250, F350 &
Bronco
1991-87

UNIT PACKAGE: 1



20847

(Not Supplied By O.E.M.)

Headlight Harness Connector
Three 16 Ga. Wire Leads
For 9008/H13 Halogen Bulb
Ford F150 Freestar
& Mercury Monterey
2004 - On

UNIT PACKAGE: 1



19126

(Not Supplied
By O.E.M.)

Plugs Into Light Socket Base For
Single Filament Wedge Type Bulbs
Back-Up Lights
Ford Ranger, Explorer & Econoline
1991-On

UNIT PACKAGE: 1



18464

(Not
Supplied
By O.E.M.)

Turn Signal Switch
Harness Connector
Fits Switch E7FZ-13341-A
Ford Tempo, Topaz, EXP, LN7, Capri,
Mustang, LTD, Marquis,
Escort & Lynx
1994-85

UNIT PACKAGE: 1

FORD SOCKET ASSY. & HARNESS CONNECTORS

Sec. 12

Use with butt connectors on pages 137 - 149 • Illustrations Not Actual Size



20547

(Not Supplied By O.E.M.)

Multi-Function Switch
Harness Connector
Fits 13K359 Switches E8DZ-B,
E8ZZ-B, E9DZ-A,B,C, E90Y-D,
E9SZ-B,D,E & F0ZZ-A,B
Ford Taurus, Sable, T-Bird,
Cougar and Continental
1993 - 86

UNIT PACKAGE: 1



20548

(Not Supplied By O.E.M.)

Multi-Function Switch
Harness Connector
Fits 13K359 Switches E8DZ-B,
E8ZZ-B, E9DZ-A, B, C, E90Y-D,
E9SZ-B, D, E & F0ZZ-A, B
Ford Taurus, Sable, T-Bird,
Cougar and Continental
1993 - 86

UNIT PACKAGE: 1



20246

(Not Supplied
By O.E.M.)

Multi-Function Switch
Repair Harness
Eleven 18 Ga. Leads
Aerostar, E Van, Expedition,
Mustang, Navigator, Sable,
Taurus & Windstar
1992 - On

UNIT PACKAGE: 1



20550

(Not Supplied
By O.E.M.)

Multi-Function Switch
Harness Connector
Fits 13K359 Switches F1AZ-A, B,
F1DZ-B, F1LY-B, F10Y-D,
F1VY-C, F3TZ-B, F3UZ-C,
F4ZZ-AA, F58Z-A, F5AZ-A,
F5TZ-B, F65Z-AA, F6DZ-A,
F75Z-AB,AC,BA, F77Z-AA,
F79Z-CA & F85Z-AA
Ford Aerostar, Bronco, Continental,
Cougar, Expedition, Explorer,
F Pick-Ups, Mark Series,
Mountaineer, Mustang, Navigator,
Ranger, Sable, T-Bird, Taurus, Town
Car & Windstar
1990 - On

UNIT PACKAGE: 1



18673

(Not Supplied
By O.E.M.)

Multi-Function Switch
(Turn Signal & Windshield Wiper)
Harness Connector

Fits Switch E9DZ-13K359-A, B, C,
E8ZZ-13K359-B & F0ZZ-13K359-A
Ford Mustang 1993-87
Taurus & Sable 1989-86

UNIT PACKAGE: 1



17623

(Not Supplied
By O.E.M.)

EEC IV Test Plug
Repair Harness Connector
Two Connectors With Eight
18 Gauge Leads
Ford 1983-On

UNIT PACKAGE: 1



19581

(Not Supplied By O.E.M.)

EEC IV Test Plug
Repair Harness Connector
One 18 Ga. Wire Lead
Ford 1983-On

**19581 Is A Component Of
Auveco 17623 Harness Connector**

UNIT PACKAGE: 5



19881

(Not Supplied By
O.E.M.)

Ignition Switch
Harness Connector
Used With Switch D0TZ-11572A,
SW944
Ford Trucks: 100-900 Series
1970-On

UNIT PACKAGE: 1



20853

(Not Supplied By O.E.M.)

Ignition Coil
Harness Connector
Two 16 Ga. Wire Leads
Fits Coils F7TZ-12029-CC
& 1L2Z-12029-AA
Ford Cars & Lt. Duty Trucks
1999 - On

UNIT PACKAGE: 1

**Please Order In Unit
Package Quantities
Not Number
Of Pieces**

Sec. 12**FORD SOCKET ASSY. & HARNESS CONNECTORS**

Use with butt connectors on pages 137 - 149 • Illustrations Not Actual Size

**20172**
(Not Supplied
By O.E.M.)EEC Relay
Harness Connector
Used With Relay E3AZ-12A646-A
Two 18 Ga. Wire Leads, Two 16 Ga.
Wire Leads & One 14 Ga. Wire lead
Ford Cars & Trucks
1981-On

UNIT PACKAGE: 1

**20844**
(Not Supplied
By O.E.M.)Electronic Ignition Module
Harness Connector
Four 16 Ga. Wire Leads
Fits Module F2PZ-12A199-AA,
DY683
Ford 1975 - On

UNIT PACKAGE: 1

**20841**
(Not Supplied By
O.E.M.)Electronic Ignition Module
Harness Connector
Four 18 Ga. Wire Leads
Fits Module F2PZ-12A199-AA,
DY683
Ford Cars & Lt. Trucks 1985 - 75
700 Series & Larger 1991 - 75

UNIT PACKAGE: 1

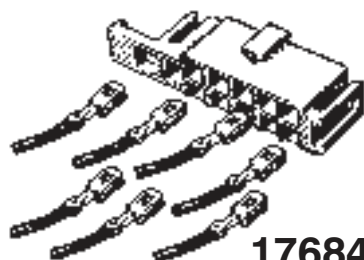
**17684**
(Not Supplied
By O.E.M.)Ignition Switch
Harness Connector
Fits Ignition Switch E6FZ-11572A
Ford 1992-80

UNIT PACKAGE: 1

**18676**
(E6DZ-14A411-A)Ignition Switch
Harness Connector
Fits Switch E7DZ-11572-A
Ford Taurus, Sable & Lincoln
Continental
1986-On

UNIT PACKAGE: 1

**18214**
(Not Supplied
By O.E.M.)Ignition Module
Harness Connector
Fits Ignition Module
E8TZ-12A297A
Ford Ranger: 1995-88

UNIT PACKAGE: 1

**18217**
(E5ZZ-12A209A)Ignition Module &
Neutral Safety Switch
Harness Connector
For E.E.C. IV Ignition
1995-83
Ford Neutral Safety
Switch E80Z-7A247-A
1988-On

UNIT PACKAGE: 1

**19623**
(Not Supplied By O.E.M.)Ignition Control Module Harness
For Modules F1AZ, F4SZ-12072A
& F5SZ-12072AA
Wire Gauge: 5 of 18 & 7 of 16
8" Leads
Ford: Full Size Trucks &
Vans, T-Bird, Cougar
Lincoln Town & Mark
1991-On

UNIT PACKAGE: 1

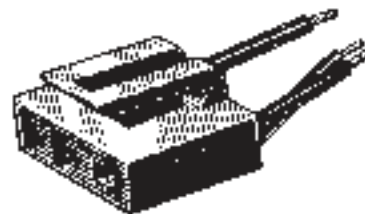
**17661**
(Not Supplied
by O.E.M.)Electronic Ignition Coil
Harness Connector
Fits Coil E73Z-12029A
Ford 1986-On

UNIT PACKAGE: 1

**20839**
(Not Supplied By O.E.M.)Coil To Ignition Harness Connector
Two 18 Ga. Wire Leads
Ford 1977 - On

UNIT PACKAGE: 10

FORD SOCKET ASSY. & HARNESS CONNECTORS

Use with butt connectors on pages 137 - 149 • Illustrations Not Actual Size

Sec. 12

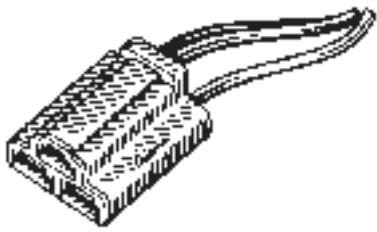

18317

(Not Supplied
By O.E.M.)

Blower Motor
Harness Connector
Heavy Duty Applications
12 Ga. Type GXL Wire
GM, Ford & Chrysler

UNIT PACKAGE: 1

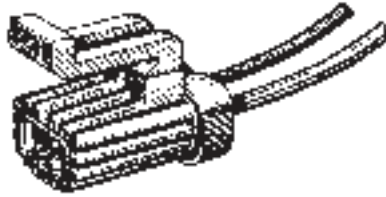

19582

(Not Supplied
By O.E.M.)

Harness Connector
For Heater Blower Motor
& Radiator Cooling Fan Motor
Ford Truck & Vans
1986-82
Ford 4-Cyl. Eng. 1979-On
Replaces Auveco 18213

UNIT PACKAGE: 5



19887

(Not Supplied
By O.E.M.)

Auxiliary Blower Switch
Harness Connector
Fits Switch F2UZ-19986C, YH-538
Ford Vans E150/350
1992-On

UNIT PACKAGE: 1



17620

(Not Supplied
By O.E.M.)

Air Conditioning
Blower Motor
Resistor Assembly
Harness Connector
Fits Resistor Assembly
E7TZ-19A706-A
Ford Trucks 1983-On

UNIT PACKAGE: 1

**You Can E-mail
Your New Item
Suggestions To
mail@auveco.com**



20849

(Not Supplied By O.E.M.)

Blower Motor Switch
Harness Connector
Five 16 Ga. Wire Leads
Fits Switches D0HZ-19986-A, YH411
Ford Heavy Duty Trucks
1989 - 1968

UNIT PACKAGE: 1



18819

(Not Supplied
By O.E.M.)

Heater & Air Conditioner
Blower Switches
Harness Connector
Fits Most Ford Switches
With Base Number 19986
1973-On

UNIT PACKAGE: 1



19883

(Not Supplied By O.E.M.)

Blower Motor Switch
Harness Connector
Used With Switch E83Z-19986A,
YH-481
Tempo & Topaz
1994-88

UNIT PACKAGE: 1

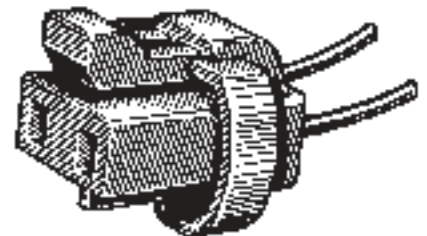

17598

(Not Supplied
By O.E.M.)

Air Conditioning Clutch
Cycling Pressure Switch
Harness Connector
Fits Switch E35Y-19E561-A
Ford 1980-On

UNIT PACKAGE: 1

Sec. 12**FORD SOCKET ASSY. & HARNESS CONNECTORS**

Use with butt connectors on pages 137 - 149 • Illustrations Not Actual Size

**20843**(F81Z-19D887-AA, WPT-169,
1U2Z-14S411-AEA)A/C Clutch Cycling Pressure Switch
Harness Connector
Four 16 Ga. Wire Leads
Fits Switches F5VY-19E561-A,
F3AZ-19D594-C, F5TZ-19D594-AA
& YH-592
Ford 1990 - On

UNIT PACKAGE: 1

**19661**

(Not Supplied By O.E.M.)

Blower Motor Resistor
Harness Connector
Fits Resistors F1CZ-19A706-A
& F7CZ-19A706-AA
One Connector Had One Each Of
8" Long 20 Ga., 16 Ga., 14 Ga. &
12 Ga. GXL Wire Leads.
The Other Connector Has
One 8" Long 12" Ga. GXL Wire Lead.
Ford Escort & Tracer
1991-On

UNIT PACKAGE: 1

**20549**(Not Supplied
By O.E.M.)Radiator Cooling
Fan Motor
Harness Connector
Fits Fan & Shroud Assemblies
F4DZ-8C607B & F5CA-8C607A
Ford Contour, Continental, Escort,
Mystique, Sable & Taurus
1997 - 90

UNIT PACKAGE: 1

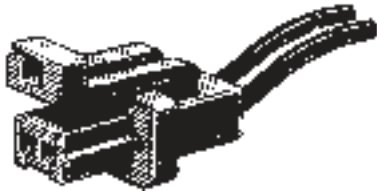
**17617**(Not Supplied
By O.E.M.)
GrayEngine Cooling Fan
Motor Switch
Harness Connector
Fits Switch E43Z-8B607-A
Ford 1984-On

UNIT PACKAGE: 1

**20277**(Not Supplied
By O.E.M.)Heater/Air Cond.
Fan Speed Switch
Harness Connector
Two 12 Ga., One 14 Ga.
& One 16 Ga. Leads
Fits Switches E6DZ-A, E9SZ-A,
F2DZ-A & F2UZ-19986A,B
Ford Cougar, E Van,
Mustang, Sable, Taurus
& T-Bird
1986 - On

UNIT PACKAGE: 1

**17619**

(E4FZ-8C290-A)

Engine Cooling Fan
Harness Connector Wiring Kit
Ford 4 Cyl. (2.3 Eng.)
With Air Conditioning
1983-On

UNIT PACKAGE: 1

**17618**(Not Supplied
By O.E.M.)
BlackEngine Cooling Fan
Motor Switch
Harness Connector
Fits Switches E5SZ-8B607-A
& E4FZ-8B607-A
Ford 1984-On

UNIT PACKAGE: 1

**20852**

(Not Supplied By O.E.M.)

Radiator Cooling Motor & Resistor
Harness Connector
Two 12 Ga. Leads
For Resistor F5RZ-8L603-AC &
Motors F8RZ-8C607-GC, GE,
RF28, RF76 & RF81
Ford Contour, Mystique & Cougar
1995 - On

UNIT PACKAGE: 1

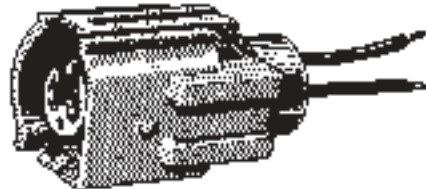
**17683**(Not Supplied
By O.E.M.)Coolant Temperature Sensor
Harness Connector
Fits Sensor E1AZ-12A648A
Ford 1981-On

UNIT PACKAGE: 1

FORD SOCKET ASSY. & HARNESS CONNECTORS

Sec. 12

Use with butt connectors on pages 137 - 149 • Illustrations Not Actual Size



18216

(Not Supplied
By O.E.M.
Gray Shell)

Exhaust Oxygen Sensor
Harness Connector
Fits Sensors F0TZ-9F472-A & C,
F09Z-9F472-A & C,
F1SZ-9F472-A & F1UZ-9F472-C
Ford: 1995-89

UNIT PACKAGE: 1

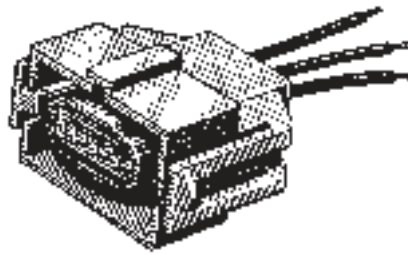

17662

(Not Supplied
By O.E.M.)

EGR Sensor Harness Connector
Fits Sensor E6AZ-9J460-A
Ford Escort, Lynx, Sable & Taurus
1988-On

UNIT PACKAGE: 1



17622

(Not Supplied
By O.E.M.)

Fuel Pump
Relay Assembly
Harness Connector
Fits Relay Assembly
E3FZ-9345-B
Ford 1983-On

UNIT PACKAGE: 1



18215

(Not Supplied
By O.E.M.
Black Shell)

Exhaust Oxygen Sensor
Harness Connector
Fits Sensors F0SZ-9F472-A & B,
F0TZ-9F472-B & E, F02Z-9F472-C
& F03Z-9F472-A
Ford 1995-89

UNIT PACKAGE: 1

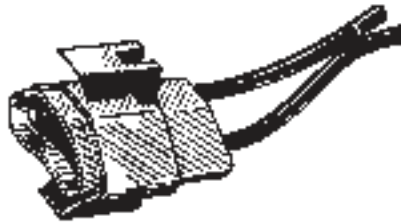

17621

(Not Supplied
By O.E.M.)

Windshield Washer
Pump Harness Connector
Fits Pumps E0AZ-17664-A &
E30Z-17664-A
Ford 1968-On

UNIT PACKAGE: 1



20842

(Not Supplied By O.E.M.)

Fuel Injectors Harness Connector
One 16 Ga. & One
18 Ga. Wire Leads
With Oval Injector Connectors
Ford 1999 - On

UNIT PACKAGE: 1



19889

Not Supplied By O.E.M.

Exhaust Oxygen Sensor
Harness Connector
Used With 3 Wire O2 Sensors
(Base No. 9F472)
Ford
1986-On

UNIT PACKAGE: 1

**For current
information on new
items available from
Auveco, refer to the
"Hot New Items"
section on the
Auveco web site
(www.auveco.com)**



16968

(12085491)

Fuel Injector Solenoid Connector
Fits GM Multi-Port Fuel Injector
1711799 on 2.8 and 3.1 liter engines
(27 models) 1986-On
Also fits Fuel Injectors on Ford,
Chrysler & Imports (Bosch)

UNIT PACKAGE: 1

Sec. 12**FORD SOCKET ASSY. & HARNESS CONNECTORS**

Use with butt connectors on pages 137 - 149 • Illustrations Not Actual Size

**18677**(Not Supplied
By O.E.M.)Idle Air By-Pass Valve
Harness Connector
Fits Valves With Ford
Base Part Number 9F715
Ford

UNIT PACKAGE: 1

**20846**

(F4VY-14A411-S)

Starter Solenoid In-line Repair
Harness Connector
12 Ga. Wire Lead
Ford & Lincoln Town Car
1997 - 91

UNIT PACKAGE: 1

**19212**(Not Supplied
By O.E.M.)Inertia Fuel Shut-Off
Switch Harness Connector
Fits Switch F5AZ-9341-A
Ford
1988-On

UNIT PACKAGE: 1

**18671**(Not Supplied
By O.E.M.)Air Conditioner
Clutch Field Coil
Harness Connector
Ford

UNIT PACKAGE: 10

**19076**(Not Supplied
By O.E.M.)Master Cylinder,
Door Jamb Switch
& Power Mirror Harness Connector
Ford 1987-On

UNIT PACKAGE: 1

**19813**

(D1AZ-13410-A)

Power Brake
Harness Connector
Ford
1965-On

UNIT PACKAGE: 10

**19156**(Not Supplied
By O.E.M.)Alternator Regulator &
Air Cond. Clutch Field
Harness Connector
Ford 1994-On

UNIT PACKAGE: 10

**19157**(Not Supplied
By O.E.M.)Variable Speed Sensor
Harness Connector
For Speed Sensors With
Ford Base No. 9E731.
Ford 1993-On

UNIT PACKAGE: 1

**20561**(Not Supplied
By O.E.M.)Brake Light Switch
Harness Connector
Fits Switches YF1Z-13480-AA
& YF1Z-13480BA
Ford, Lincoln & Mercury
2000 - On
Ford Explorer & Mercury
Mountaineer
1999 - 98

UNIT PACKAGE: 1

FORD SOCKET ASSY. & HARNESS CONNECTORS

Use with butt connectors on pages 137 - 149 • Illustrations Not Actual Size



20845

(Not Supplied By O.E.M.)

Cam Shaft And Crank Shaft Sensors
Harness Connector
Two 18 Ga. Leads
Fits Sensors F0CZ-6B288-A,
F1AZ-6B288-A, F1AZ-6C315-A &
XC3Z-6B288-AA
Ford 1991 - On

UNIT PACKAGE: 1



20840

(Not Supplied By O.E.M.)

Glow Plug Pass Thru At Valve
Cover Gasket Harness Connector
Two 16 Ga. & Three
18 Ga. Wire Leads
Ford E350, F250-F550SD
& Excursion 7.3 Diesel
1996 - On

UNIT PACKAGE: 1



17659

(Not Supplied
By O.E.M.)

Voltage Regulator Plug
Harness Connector
Sable, Taurus, Tempo & Topaz
With Internal Voltage Regulator
1986-On

UNIT PACKAGE: 1



19880

(Not Supplied
By O.E.M.)

Transmission Gear Shift
Position Sensor Harness Connector
Eight Wire Leads
Used With Switch F5TZ-7A247 on
Ford Trucks w/ E 4 OD Transmission,
RWD 1989-84 and E, F & U Series
1989-On

UNIT PACKAGE: 1



19885

(F4PZ-14A411C)

Windshield Wiper Motor
Harness Connector
For New Single Connector
Replacement Motors (6 Positions)
Ford 1987-On

UNIT PACKAGE; 1



11445

Voltage Regulator
Harness Connector
Ford

UNIT PACKAGE: 10



19004

(F2PZ-14A464C,
F4UB-14A464A)

Transmission MLP Sensor
Harness Connector
E150/350, F250/350
& U150 (Bronco)
1990-On

UNIT PACKAGE: 1



18668

(Not Supplied
By O.E.M.)

In-Tank Fuel Pump &
Sending Unit Connector
Ford 1985-On

UNIT PACKAGE: 5



20850

(Not Supplied By O.E.M.)

Voltage Regulator
Harness Connector
Four 14 Ga. & Two 18 Ga.
Wire Leads
Fits Voltage Regulator
F0PZ-10316-A
Ford 1975 - On

UNIT PACKAGE: 10

Sec. 12

FORD SOCKET ASSY. & HARNESS CONNECTORS

Use with butt connectors on pages 137 - 149 • Illustrations Not Actual Size



18218
(Not Supplied
By O.E.M.)

Alternator Harness Connector
Ford Aerostar, Tempo, Topaz, Taurus & Sable w/6 Cyl.
Eng. & 75 Amp. Alt. 1989-On
4 Cyl. Eng. 1985-On

UNIT PACKAGE: 1

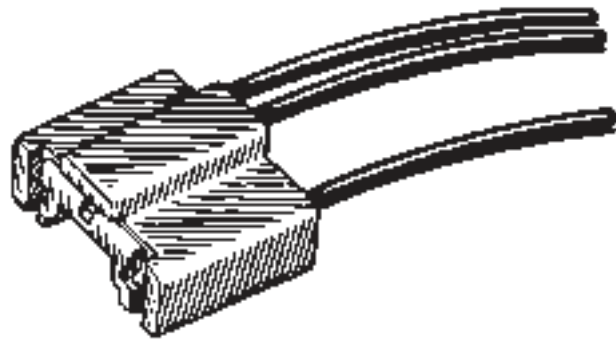

11437

Dimmer Switch
Harness Connector
Ford & Chrysler

UNIT PACKAGE: 10



20851
(1U2Z-14S411-TA, WPT118)

Alternator Harness Connector
Three 14 Ga. Wire Leads
Ford 1996 - On

UNIT PACKAGE: 1

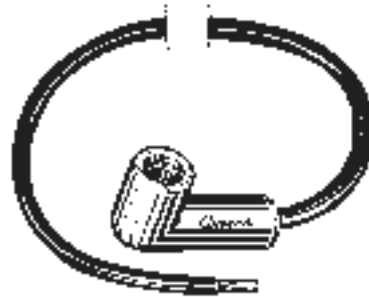

13644

Right Angle Pigtail
General Purpose
11-1/2" Wire Lead For .160 Stud
Ford

UNIT PACKAGE: 10



20838
(Not Supplied By O.E.M.)

Alternator Harness Connector
Two 16 Ga. Wire Leads
100 Amp Alternator
Ford 1990 - 75

UNIT PACKAGE: 10

**Do You Want Your Customers To
Know You Use The Best Body
Hardware & Specialty Fasteners
Available?**

**Promotional Products And Apparel
Bearing The Auveco Logo Promote
Your Identify As A Professional.**

CHRYSLER SOCKET ASSY. & HARNESS CONNECTORS

Sec. 12

Use with butt connectors on pages 137 - 149 • Illustrations Not Actual Size

12237

(Chrys: 3744750;
GM: 12004311,
25015169; Ford: C8OZ-13711A)

Instrument Panel Socket
For 1/2" Hole
Bulb No. 194
GM, Ford & Chrysler
UNIT PACKAGE: 2



12598

(3764865, 3843245,
4124721, 4163003)

Single Contact With Ground
Bulb Nos. 87, 93, 1073, 1141 & 1156
Chrysler
UNIT PACKAGE: 1

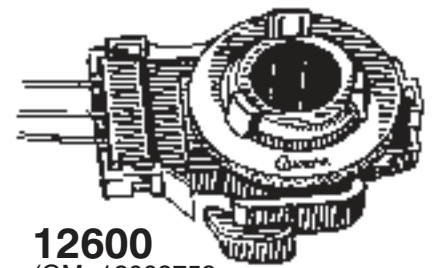

12600

(GM: 12003759;
AMC: 812893)

90° Pigtail & Socket Assembly
Bulb Nos. 1016, 1034, 1154 & 1157
GM & AMC
UNIT PACKAGE: 1

9905

(Chrys: 2496279;
GM: 2973932;
AMC: 3509575;
IHC: 374985C1)

Instrument Panel Socket
For 5/8" Hole
Bulb No. 194
GM, Chrysler, AMC & International
UNIT PACKAGE: 10



12599

(3764863)

Double Contact, With Ground
Bulb Nos. 1034, 1154 & 1157
Chrysler
UNIT PACKAGE: 1



18919

(4636359)

Signal & Park Lights
Chrysler 1984-On
UNIT PACKAGE: 1



13541

(3588314)

Side Marker Assembly
Bulb Nos. 194, 194A
Chrysler
UNIT PACKAGE: 2



13233

(3843432)

Signal & Park Lights
Bulb Nos. 198, 1016, 1034,
1154 & 1157
Chrysler
UNIT PACKAGE: 1



18921

(4636360)

Signal, Park & Back-Up Lights
Chrysler 1993-88
UNIT PACKAGE: 1



13542

(3513686, 4055028)

Side Marker Assembly
Bulb Nos. 194, 194A
Chrysler
UNIT PACKAGE: 2



20389

(Not Supplied By O.E.M.)

Signal, Stop, Tail & Turn Lights
Bulb No. 1157
Chrysler Including Trucks
1992 - 89
UNIT PACKAGE: 1



18920

(4636362)

Back-Up Lights
Chrysler 1990-On
UNIT PACKAGE: 1

Sec. 12 CHRYSLER SOCKET ASSY. & HARNESS CONNECTORS

Use with butt connectors on pages 137 - 149 • Illustrations Not Actual Size



11157

(AMC: 4486948;
GM: 8912698, 6299087)
Signal, Park, Stop & Tail Lights
Bulb Nos. 1034, 1154 & 1157
GM & AMC
UNIT PACKAGE: 1



21490

(GM: 12102664, 88862264)
(Ford: 1U2Z-14S411-YA)
Fog & Front Lights,
Pwr. Steering & Oil Pressure Switch
Harness Connector
GM 2005 - 1986
Ford 2004 - 1995
Jeep Eagle 1994
UNIT PACKAGE: 1

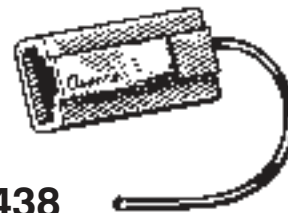

11438

Temperature Sending Unit
Harness Connector
GM
Voltage Regulator
Harness Connector
Chrysler
UNIT PACKAGE: 10

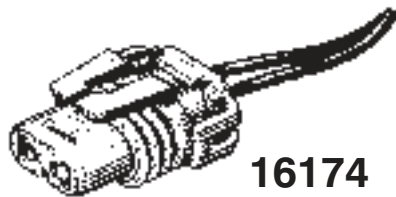

16174

Headlight Socket Assembly
For Low Beam 9006 Halogen Bulb
Single Indexing Groove
GM, Ford, AMC & Imports
UNIT PACKAGE: 4

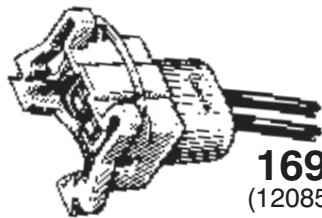

16968

(12085491)
Fuel Injector Solenoid
Connector Pigtail
Fits GM Multi-Port Fuel Injector
1711799 on 2.8 and 3.1 liter engines
(27 models) 1986-On
Also fits Fuel Injectors on Ford,
Chrysler & Imports (Bosch)
UNIT PACKAGE: 1

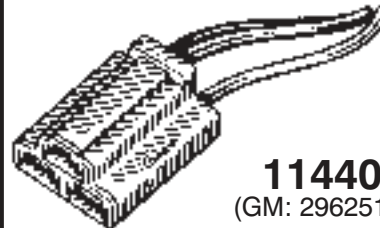

11440

(GM: 2962510)
Air Conditioner Blower
Relay Harness Connector
GM, AMC & Chrysler
UNIT PACKAGE: 10

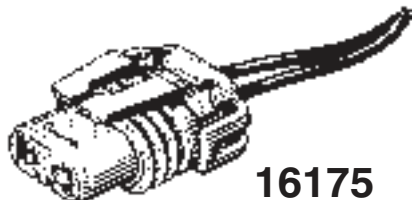

16175

Headlight Socket Assembly
For High Beam 9005 Halogen Bulb
Two Indexing Grooves
GM, Ford, AMC & Imports
UNIT PACKAGE: 4

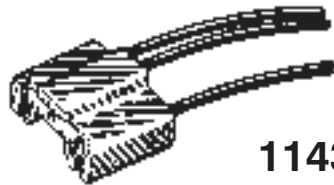

11437

Dimmer Switch Harness Connector
Ford & Chrysler
UNIT PACKAGE: 10



18317

Not Supplied By O.E.M.
Blower Motor Harness Connector
Heavy Duty Applications 12 Ga.
Type GXL Wire
GM, Ford & Chrysler
UNIT PACKAGE: 1

IMPORT CAR HARNESS CONNECTORS



21210

(Not Supplied
By O.E.M.)

Universal Headlight Harness
Connector For H7 Halogen
Bulbs; Two 18 Gauge 6"
Long Leads; Ford, Audi,
BMW, Hyundai, Kia, Mazda,
Mercedes, Mini Cooper,
Saab & Subaru

UNIT PACKAGE: 1

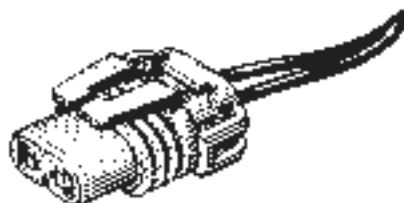

16174

(GM: 12101897)

Headlight Socket Assembly
For Low Beam 9006 Halogen Bulb
Single Indexing Groove
GM, Ford, AMC & Imports

UNIT PACKAGE: 4

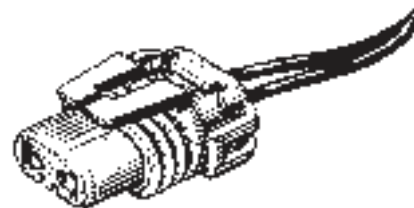

16175

(GM: 12101898)

Headlight Socket Assembly
For High Beam 9005 Halogen Bulb
Two Indexing Grooves
GM, Ford, AMC & Imports

UNIT PACKAGE: 4

IMPORT CAR HARNESS CONNECTORS

Sec. 12

Use with butt connectors on pages 137 - 149 • Illustrations Not Actual Size



21220
(GM: 88987187)

Headlight Socket Assembly
For H9 Halogen Bulb
GM, Audi, Mazda,
Mini-Cooper, Porsche,
Volkswagen & Volvo
UNIT PACKAGE: 1



14918
(12048369)

Headlight Socket Assembly For
High-Low 9004 & 9007 Halogen Bulb
GM, Ford & Imports
UNIT PACKAGE: 1

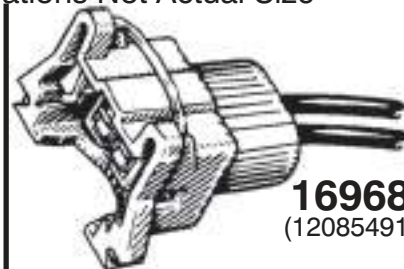

16968
(12085491)

Fuel Injector Solenoid
Harness Connector.
Fits GM Multi-Port Fuel Injector
1711799 on 2.8 and 3.1 liter engines
(27 models) 1986-On
Also fits Fuel Injectors on Ford,
Chrysler & Imports (Bosch)
UNIT PACKAGE: 1

UNIVERSAL PIGTAIL SOCKET ASSEMBLIES & HARNESS CONNECTORS



5219

Pigtail Connector
Single Small Wire Lead - 12" Long
For Sockets Housing Miniature
Lights
UNIT PACKAGE: 10



5220

Pigtail Connector
Single Large Wire Lead - 12" Long
For Sockets Housing
Single Contact Lights
UNIT PACKAGE: 10



5221

Pigtail Connector
Double Wire Lead - 12" Long
Aligned Ears.
For Sockets Housing Double
Contact Lights
UNIT PACKAGE: 10



8763
(13235-A)

Weatherproof Covered Neoprene
Signal, Park, Stop & Tail Lights
Bulb Nos. 198, 1016, 1034, 1154 &
1157
UNIT PACKAGE: 10



5226

Universal Signal, Park, Stop &
Tail Lights
Bulb Nos. 198, 1016, 1034,
1154 & 1157
For 7/8" to 1-1/8" Hole
UNIT PACKAGE: 10

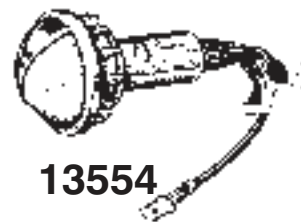

13554

Shielded License/Utility Light
Sealed Socket Assembly with Chrome
Plastic Shield
14" Sealed Plastic Boot
28" Lead w/Male Spade Terminal
Bulb Included-Mounts in 1-1/4" Hole
UNIT PACKAGE: 1



8764

Single Contact License Plate Lights
Bulb Nos. 63, 67, 87, 89, 93, 97,
209, 1003, 1073, 1129, 1133,
1141 & 1156
For 7/8"-1-1/8" Holes
UNIT PACKAGE: 5



5225

Pigtail Connector
Three Wire Sealed Beam
12" Long - Molded
UNIT PACKAGE: 10



11439

Headlight & Flasher
For all cars using 3 prong sealed
Headlight Bulbs 4002, 3, 5, 5040, 2,
5400, 2, 40, 421, 6006, 12 & 13.
Also fits 2 & 3 Prong Flashers
UNIT PACKAGE: 10

UNIVERSAL SOCKET ASSY. & HARNESS CONNECTORS

Use with butt connectors on pages 137 - 149 • Illustrations Not Actual Size

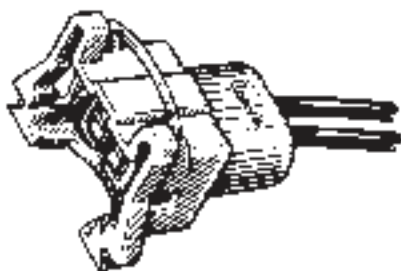

16968

(12085491)

Fuel Injector Solenoid
Connector Pigtail
Fits GM Multi-Port Fuel Injector
1711799 on 2.8 and 3.1 liter engines
(27 models) 1986-On
Also fits Fuel Injector on Ford,
Chrysler & Imports (Bosch)

UNIT PACKAGE: 1



13559

Headlight & Flasher
For all cars using 2 prong Sealed
Headlight Bulb No. 4001

UNIT PACKAGE: 3

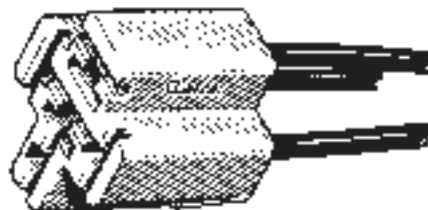

16966

Three terminal Flasher connector
pigtail designed specifically
for heavy duty thermal
and electronic flashers with
variable and fixed loads - single
and alternating flash patterns.
Features three 10" long 14 gauge
GXL wire leads.

UNIT PACKAGE: 2

This catalog includes **Specification Charts** to assist you in the identification of various types of fasteners. The charts can be found on the following pages:

Body Bolts (pages 20 & 49-50)

Special Tapping Screws (pages 23-26 & 54-57)

License Plate Screws (pages 33-34)

"Xmas Tree" Retainers (pages 404-413)

Push-Type Retainers (pages 450 - 460)

The charts list the pertinent dimensions, plating or color information and the page number on which the actual size picture and application information is shown for each item.

UNIVERSAL SOCKET ASSY. & HARNESS CONNECTORS **Sec. 12**

Use with butt connectors on pages 137 - 149 • Illustrations Not Actual Size



9901

Pigtail Connector
Single Wire Lead, 16 Ga., 12" Long
Receptacle for use wherever there is
a junction of two or more wires; such
as behind an instrument panel or in
an engine compartment. Use
w/Auveco No. 9900.

UNIT PACKAGE: 20



9900

Pigtail Connector
Single Wire Lead, 16 Ga., 12" Long
Snap plug for use wherever there is
a junction of two or more wires; such
as behind an instrument panel or in
an engine compartment. Use
w/Auveco No. 9901.

UNIT PACKAGE: 20



8770

2 Way Harness Connector
7-1/2" Leads, 18 Ga.
Automotive, Truck and Marine. Use
where a double harness is required.
Also used on Trailers and Farm
Implements.

UNIT PACKAGE: 5



8768

3-Way Harness Connector
7-1/2" Leads
Color Coded Wire Automotive,
Truck and Marine. Use where a Triple
Harness is required.
Use with Auveco No. 8769

UNIT PACKAGE: 5



8769

3-Way Harness Connector
7-1/2" Leads
Color Coded Wire Automotive, Truck
and Marine. Use where a Triple
Harness is required.
Use with Auveco No. 8768

UNIT PACKAGE: 5



10222

4 Way Harness Connector
12" Leads, 18 Ga.
For: Automotive, Truck Trailer Marine
and Farm Implement Use.
Use With Auveco No. 10223

UNIT PACKAGE: 5



10223

4 Way Harness Connector
12" Leads, 18 Ga.
For: Automotive, Truck, Trailer,
Marine and Farm Implement Use.
Use w/ Auveco No. 10222

UNIT PACKAGE: 5



10782

4 Way Harness Connector
48" Wire Leads, 18 Ga.
For: Automotive, Truck, Trailer,
Marine and
Farm Implement Use
Use w/ Auveco No. 10783

UNIT PACKAGE: 2



10783

4 Way Harness Connector.
48" Wire Leads, 18 Ga.
For: Automotive, Truck, Trailer,
Marine and
Farm Implement Use.
Use w/ Auveco No. 10782

UNIT PACKAGE: 2

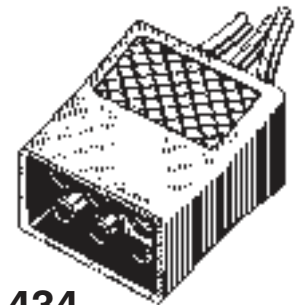

11434

Six Way Trailer Connector
6 Color Coded Wire Leads
(Male) For Trailer Application
Use with Auveco No. 11435

UNIT PACKAGE: 5

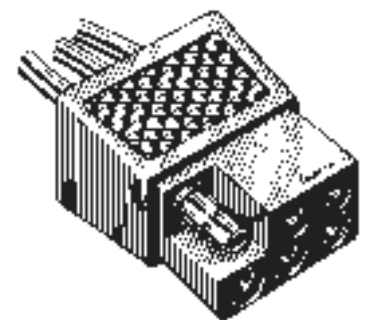

11435

Six Way Trailer Connector
6 Color Coded Wire leads
(Female) For Trailer Application
Use with Auveco No. 11434

UNIT PACKAGE: 5

Sec. 12 UNIVERSAL SOCKET ASSY. & HARNESS CONNECTORS
 Use with butt connectors on pages 137 - 149 • Illustrations Not Actual Size



13634

Complete 4-Way Trailer Connector. Polarized four prong. Chrome plated die cast housing. 2-hole flange mounting 1-13/16" on centers. Mounting bracket available.

UNIT PACKAGE: 1 Set



13640

6-Way Trailer Connector Socket

UNIT PACKAGE: 1



13639

6-Way Trailer Connector Plug

UNIT PACKAGE: 1



13636

Complete 6-Way Trailer Connector Assembly consists of 13639 plug and 13640 socket. Specifically designed for Recreational Vehicles. Die cast plug housing is chrome plated and socket is a one piece plastic molded unit complete with plated spring loaded cover and a special moisture and dust-proof boot.

UNIT PACKAGE: 1 Set

AuvecoPak: The fastest moving, most popular, automotive body hardware and specialty fastener items in a one-price bag. Refer to the color pages at the front of the catalog.



13643

Universal Bracket
 For use with 13634 and 13640 trailer connectors. Designed to fit under trailer high ball. Heavy gauge zinc plated steel.

UNIT PACKAGE: 2

MINIATURE BULBS



Auveco Part No.	Type	Replaces Bulb No.	Unit Pkg.	Auveco Part No.	Type	Replaces Bulb No.	Unit Pkg.	Auveco Part No.	Type	Replaces Bulb No.	Unit Pkg.
-----------------	------	-------------------	-----------	-----------------	------	-------------------	-----------	-----------------	------	-------------------	-----------

Wagner Miniature Bulbs

168991115710	169251103410	18015129010
1690111157NA10	1692639310	1801627410
16902219410	169278PR210	18017132410
169043115610	1759731156NA10	180181324NA10
1690546710	1799491305010	1846523710
169064189510	1799591210010	18466319910
169071205710	1799618315610	18467429310
1690812057NA10	1799718315510	18468463110
169095189310	179983239610	184691107610
1691045710	179991235710	184704115510
1691148910	1800012357NA10	184724144510
1691249710	1800173157NA10	1847314144910
169136211-210	180025189110	184745181510
1691445310	180035188910	18475183156NA10
169157305710	180043107310	18476183157NA-SA10
1691673057NA10	180051092110	184777335710
169177315710	180061091610	1847873357NA10
169183100310	1800710916NA10	18479153157SA10
169195181610	180081091210	192061674402
1692017100410	180101156110	192071674432
16921216810	180116212-210	1920831295NA10
169221090610	180122194NA10				
169233114110	18013219310				
16924119810	18014215810				

(Continued on next page)

MINIATURE BULBS

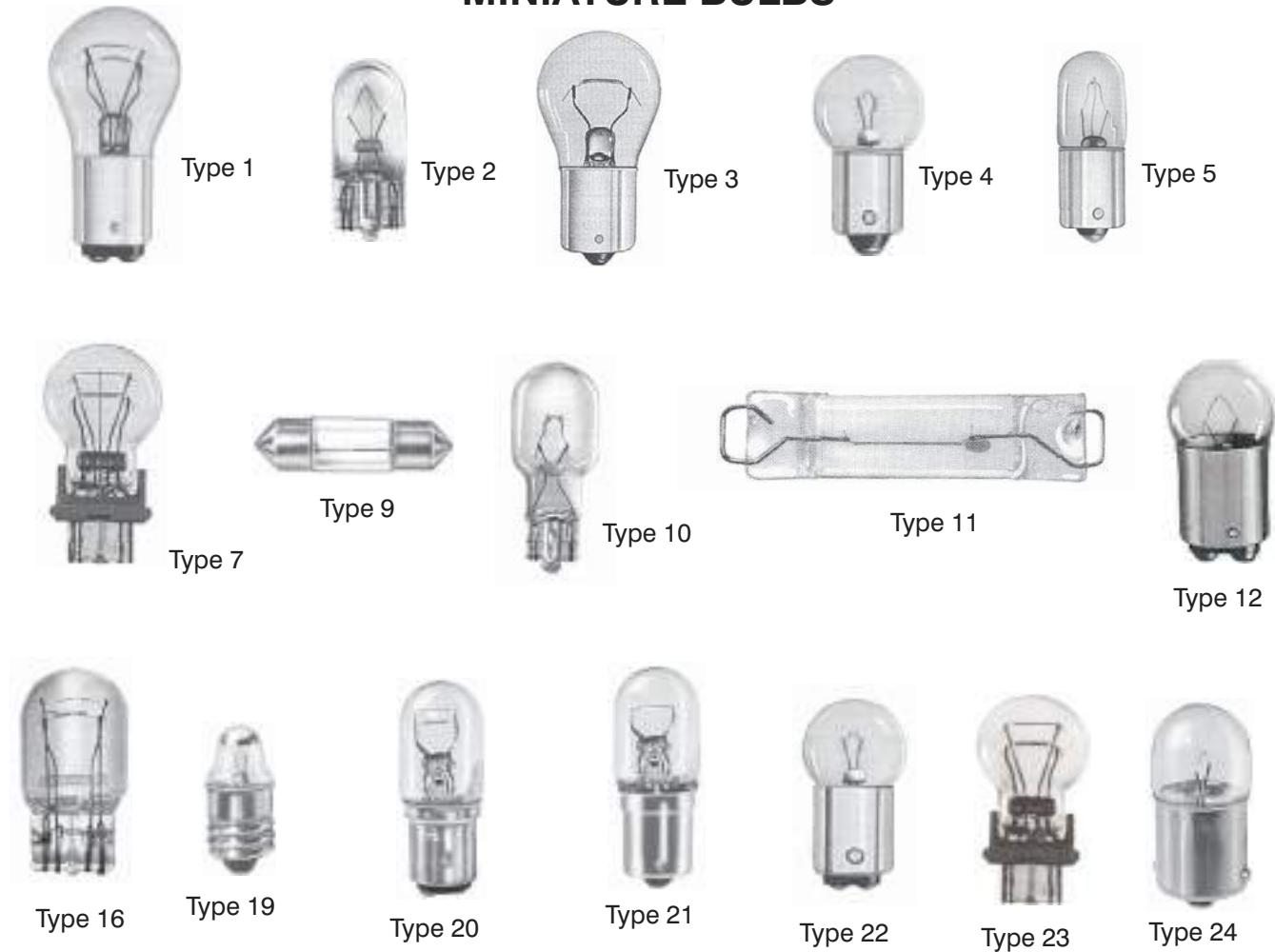

Auveco Part No.	Type	Replaces Bulb No.	Unit Pkg.	Auveco Part No.	Type	Replaces Bulb No.	Unit Pkg.	Auveco Part No.	Type	Replaces Bulb No.	Unit Pkg.
-----------------	------	-------------------	-----------	-----------------	------	-------------------	-----------	-----------------	------	-------------------	-----------

Wagner Miniature Bulbs

(Continued from previous page)

20282	4	55	10	20293	10	917	10	20588	23	3457NA	10
20283	4	63	10	20294	10	922	10	20589	5	17131	10
20284	2	73	10	20295	1	1638	10	20590	24	17171	10
20285	16	161	10	20296	20	3496	10	20591	2	17177	10
20286	16	192	10	20297	21	3497	10	20592	3	17635	10
20287	19	222	10	20298	16	3652	10	20593	1	17916	10
20288	16	558	10	20299	9	11005	10	20620	7	4157LL	2
20289	11	562	10	20300	9	11006	10	20621	7	4157NALL	2
20291	10	904	10	20585	1	1176	10	20681	1	1142	10
20292	12	68	10	20587	23	3457	10	20859	7	3757NALL	2

A - Amber (Darker)
 LL - Long Life
 NA - Natural Amber (Lighter)
 SA - Special Application

WAGNER HALOGEN LIGHT BULBS

Illustrations Are Not Actual Size

Sec. 12



16896

9004/HB1 Bulb
High-Low Beam
In Single Headlight Assemblies
12-18 Volts, 25-65 Watts
Use With Auveco Socket 14918

UNIT PACKAGE: 1



20682

9005LL/HB3 Bulb

UNIT PACKAGE: 1



20595

881 Bulb

UNIT PACKAGE: 1



18662

9007/HB5 Bulb
High-Low Beam
12.8 Volts,
55-65 Watts
Use With Auveco
Socket 14918

UNIT PACKAGE: 1



16898

9006/HB4 Bulb
Low Beam
In Dual Headlight Assemblies
12.8 Volts, 55 Watts
Use With Auveco Socket 16174

UNIT PACKAGE: 1



20597

889 Bulb

UNIT PACKAGE: 1



16897

9005/HB3 Bulb
High Beam
In Dual Headlight Assemblies
12.8 Volts, 65 Watts
Use With Auveco Socket 16175

UNIT PACKAGE: 1



20683

886 Bulb

UNIT PACKAGE: 1



18661

9003/HB2 Bulb
High-Low Beam
12.0 Volts,
55-60 Watts
Use With Auveco
Socket 5225

UNIT PACKAGE: 1

WAGNER HALOGEN LIGHT BULBS

Illustrations Are Not Actual Size



20601

1260/H4 Bulb

UNIT PACKAGE: 1



20596

885 Bulb

UNIT PACKAGE: 1



19209

2040 Bulb
Center Grille
Mercury
Sable and Villager

UNIT PACKAGE: 1



20598

891 Bulb

UNIT PACKAGE: 1



20594

880 Bulb

UNIT PACKAGE: 1



20599

893 Bulb

UNIT PACKAGE: 1



20600

1255/H3 Bulb

UNIT PACKAGE: 1

**Please Order In
Unit Package Quantity
Not Pieces**

BULB NUMBER TO AUVECO'S WAGNER BULB PART NUMBER

Bulb No.	Auveco No.	Bulb No.	Auveco No.	Bulb No.	Auveco No.
H3	20600	885	20596	2357NA	18000
H4	20601	886	20683	2396	17998
HB1	16896	889	20597	3057	16915
HB2	18661	891	20598	3057NA	16916
HB3	16897, 20682	893	20599	3155	17997
HB4	16898	904	20291	3156	17996
HB5	18662	906	16922	3156NA	18475
PR2	16927	912	18008	3157	16917
24	18017	916	18006	3157NA	18001
24NA	18018	916NA	18007	3157NA-SA	18476
37	18465	917	20293	3157SA	18479
53	16914	921	18005	3357	18477
55	20282	922	20294	3357NA	18478
57	16910	1003	16918	3457	20587
63	20283	1004	16920	3457NA	20588
67	16905	1034	16925	3496	20296
68	20292	1073	18004	3497	20297
73	20284	1076	18469	3652	20298
74	18016	1141	16923	3757NALL	20859
89	16911	1142	20681	4157LL	20620
90	18015	1155	18470	4157NALL	20621
93	16926	1156	16904	7440	19206
97	16912	1156NA	17597	7443	19207
158	18014	1157	16899	9003/HB2	18661
161	20285	1157NA	16901	9004/HB1	16896
168	16921	1176	20585	9005/HB3	16897
192	20286	1255/H3	20600	9005LL/HB3	20682
193	18013	1260/H4	20601	9006/HB4	16898
194	16902	1295NA	19208	9007/HB5	18662
194NA	18012	1445	18472	11005	20299
198	16924	1449	18473	11006	20300
199	18466	1638	20295	12100	17995
211-2	16913	1815	18474	13050	17994
212-2	18011	1816	16919	17131	20589
222	20287	1889	18003	17171	20590
293	18467	1891	18002	17177	20591
558	20288	1893	16909	17635	20592
561	18010	1895	16906	17916	20593
562	20289	2040	19209		
631	18468	2057	16907		
880	20594	2057NA	16908		
881	20595	2357	17999		

Halogen Bulb Industry Standard Number To Auveco Harness Connector Number

Halogen Bulb No.	Auveco No.	Halogen Bulb No.	Auveco No.	Halogen Bulb No.	Auveco No.
880	21490	898	16694	H8	16694
881	16694	899	21490	H9	21220
884	21490	9003	11439	H10	16175
885	21490	9004	14918	H11	16694
886	16694	9005	16175	H12	16175
889	16694	9006	16174	H13	20847
890	21490	9007	14918	HB1	14918
892	21490	9008	20847	HB2	11439
893	21490	9055	16175	HB3	16175
894	16694	H4	11439	HB4	16174
896	16694	H7	21210	HB5	14918

Sec. 12

HIGH PERFORMANCE IMPORTED MINIATURE & HALOGEN BULBS



Type 1



Type 2



Type 3



Type 4



Type 5



Type 7



Type 10



Type 12



Type 13



Type 15



Type 16



Type 18



Type 23

HIGH PERFORMANCE IMPORTED MINIATURE BULBS

Auveco Part No.	Type	Replaces Bulb No.	Unit Pkg.	Auveco Part No.	Type	Replaces Bulb No.	Unit Pkg.	Auveco Part No.	Type	Replaces Bulb No.	Unit Pkg.
B24	13	24	10	B916	10	916	10	B3057A	7	3057A	10
B24A	13	24A	10	B916A	10	916A	10	B3156	18	3156	10
B53	4	53	10	B921	10	921	10	B3156A	18	3156A	10
B57	4	57	10	B921A	10	921A	10	B3157	7	3157	10
B67	4	67	10	B1141	3	1141	10	B3157A	7	3157A	10
B67A	4	67A	10	B1156	3	1156	10	B3357	7	3357	10
B68	12	68	10	B1156A	3	1156A	10	B3357A	7	3357A	10
B89	4	89	10	B1157	1	1157	10	B3457	23	3457	10
B97	4	97	10	B1157A	1	1157A	10	B3457A	23	3457A	10
B168	2	168	10	B1893	5	1893	10	B4114K	15	4114K	10
B194	2	194	10	B1895	4	1895	10	B4157	7	4157	10
B194-100	2	194	100	B2057	1	2057	10	B4157K	7	4157K	10
B194A	2	194A	10	B2057A	1	2057A	10	B7440	16	7440	10
B906	10	906	10	B2357	1	2357	10	B7440A	16	7440A	10
B906A	10	906A	10	B2357A	1	2357A	10	B7443	16	7443	10
B912	10	912	10	B3057	7	3057	10	B7443A	16	7443A	10

HIGH PERFORMANCE IMPORTED HALOGEN BULBS

Pictures Are Not Actual Size



B880

880 Bulb

UNIT PACKAGE: 1



B881

881 Bulb

UNIT PACKAGE: 1



B884

884 Bulb

UNIT PACKAGE: 1



B885

885 Bulb

UNIT PACKAGE: 1



B886

886 Bulb

UNIT PACKAGE: 1



B889

889 Bulb

UNIT PACKAGE: 1



B890

890 Bulb

UNIT PACKAGE: 1



B891

891 Bulb

UNIT PACKAGE: 1



B893

893 Bulb

UNIT PACKAGE: 1

Sec. 12

HIGH PERFORMANCE IMPORTED HALOGEN BULB

Pictures Are Not Actual Size



B894

894 Bulb

UNIT PACKAGE: 1



B896

896 Bulb

UNIT PACKAGE: 1



B899

899 Bulb

UNIT PACKAGE: 1



B9004

9004/HB1 Bulb
High-Low Beam
In Single
Headlight Assemblies
12 - 18 Volts
25 - 65 Watts
Use With Auveco Socket 14918

UNIT PACKAGE: 1



B9005

9005/HB3 Bulb
High Beam
In Dual
Headlight Assemblies
12.8 Volts
65 Watts
Use With Auveco Socket 16175

UNIT PACKAGE: 1



B9006

9006/HB4 Bulb
Low Beam
In Dual
Headlight Assemblies
12.8 Volts
55 Watts
Use With Auveco Socket 16174

UNIT PACKAGE: 1



B9007

9007/HB5 Bulb
High-Low Beam
12.8 Volts
55-65 Watts
Use With Auveco Socket 14918

UNIT PACKAGE: 1



BD1S
D1S Bulb

UNIT PACKAGE: 1



BD2C

D2C Bulb

UNIT PACKAGE: 1

HIGH PERFORMANCE IMPORTED HALOGEN BULBS

Sec. 12

Pictures Are Not Actual Size



BD2R

D2R Bulb

UNIT PACKAGE: 1



BD2S

D2S Bulb

UNIT PACKAGE: 1



BH1

H1 Bulb

UNIT PACKAGE: 1



BH3

H3/1255 Bulb

UNIT PACKAGE: 1



BH7

H7 Bulb

UNIT PACKAGE: 1



BH9

H9 Bulb

UNIT PACKAGE: 1



BH10

H10/9145 Bulb

UNIT PACKAGE: 1



BH11

H11 Bulb

UNIT PACKAGE: 1



BH13

H13/9008 Bulb

UNIT PACKAGE: 1

BULB NUMBER TO AUVECO'S HIGH PERFORMANCE IMPORTED BULB PART NUMBER

Bulb No.	Auveco No.	Bulb No.	Auveco No.	Bulb No.	Auveco No.	Bulb No.	Auveco No.	Bulb No.	Auveco No.
24	B24	889	B889	1157	B1157	3457	B3457	D2R	BD2R
24A	B24A	890	B890	1157A	B1157A	3457A	B3457A	D2S	BD2S
53	B53	891	B891	1255	BH3	4114K	B4114K	H1	BH1
57	B57	893	B893	1893	B1893	4157	B4157	H3	BH3
67	B67	894	B894	1895	B1895	4157K	B4157K	H7	BH7
67A	B67A	896	B896	2057	B2057	7440	B7440	H9	BH9
68	B68	899	B899	2057A	B2057A	7440A	B7440A	H10	BH10
89	B89	906	B906	2357	B2357	7443	B7443	H11	BH11
97	B97	906A	B906A	2357A	B2357A	7443A	B7443A	H13	BH13
168	B168	912	B912	3057	B3057	9004	B9004	HB1	B9004
194	B194	916	B916	3057A	B3057A	9005	B9005	HB3	B9005
194A	B194A	916A	B916A	3156	B3156	9006	B9006	HB4	B9006
880	B880	921	B921	3156A	B3156A	9007	B9007	HB5	B9007
881	B881	921A	B921A	3157	B3157	9008	BH13		
884	B884	1141	B1141	3157A	B3157A	9145	BH10		
885	B885	1156	B1156	3357	B3357	D1S	BD1S		
886	B886	1156A	B1156A	3357A	B3357A	D2C	BD2C		

Sec. 12

PREMIUM IMPORTED MINIATURE BULBS



Type 1



Type 2



Type 3



Type 4



Type 5



Type 7



Type 9



Type 10



Type 13



Type 16



Type 20



Type 21



Type 23



Type 25

Auveco Part No.	Type	Replaces Bulb No.	Unit Pkg.	Auveco Part No.	Type	Replaces Bulb No.	Unit Pkg.	Auveco Part No.	Type	Replaces Bulb No.	Unit Pkg.
-----------------	------	-------------------	-----------	-----------------	------	-------------------	-----------	-----------------	------	-------------------	-----------

PREMIUM IMPORTED MINIATURE BULBS

19608	3	1156	10	20711	10	916	10	20723	7	3057NA	10
19610	1	1157NA	10	20712	10	916NA	10	20726	7	3157	10
19612	2	194NA	10	20713	10	921	10	20727	7	3157NA	10
20702	13	24NA	10	20714	3	1156NA	10	20728	23	3457	10
20703	4	57	10	20715	5	1893	10	20729	23	3457NA	10
20705	4	89	10	20716	4	1895	10	20730	20	3496	10
20706	2	168	10	20718	1	2057	10	20731	21	3497	10
20707	9	211-2	10	20720	1	2357	10	20732	16	7440	10
20709	10	906	10	20721	1	2357NA	10	21031	25	7440NA	2
20710	10	912	10	20722	7	3057	10				

NA - Natural Amber (Lighter)



Not Actual Size

20855

881 Bulb

UNIT PACKAGE: 1



Not Actual Size

20781

9007/HB5 Bulb
High-Low Beam
12.8 Volts, 55-65 Watts
Use With Auveco Socket 14918

UNIT PACKAGE: 1



Not Actual Size

20778

9004/HB1 Bulb
High-Low Beam
In Single
Headlight Assemblies
12 - 18 Volts
25 - 65 Watts
Use With Auveco
Socket 14918

UNIT PACKAGE: 1

Not Actual Size



21222

H9 Bulb
High Beam
12 Volts, 65 Watts
Use With Auveco
Headlight Socket 21220

UNIT PACKAGE: 1



Not Actual Size

20856

885 Bulb

UNIT PACKAGE: 1



20717

2040 Bulb
Center Grille
Mercury Sable
and Villager

UNIT PACKAGE: 1

Not Actual Size



20857

889 Bulb

UNIT PACKAGE: 1

Not Actual Size



21163

(2C5Z-13N021-AA)

H11 Bulb
Ford Headlight

UNIT PACKAGE: 1



Not Actual Size

21057

(XL3Z-13466-AA)

9145/H10 Bulb
Ford Fog Lamp

UNIT PACKAGE: 1

Not Actual Size



20858

893 Bulb

UNIT PACKAGE: 1

Sec. 12 PREMIUM IMPORTED HALOGEN LIGHT BULBS



UNIT PACKAGE: 1



UNIT PACKAGE: 1



UNIT PACKAGE: 1



UNIT PACKAGE: 1

For the most recent information on new items available from Auveco, refer to the "Hot New Items" section of the Auveco web site (www.auveco.com)

BULB NUMBER TO AUVECO'S PREMIUM IMPORTED BULB PART NUMBER

Bulb No.	Auveco No.	Bulb No.	Auveco No.	Bulb No.	Auveco No.
H1.....	21029	889	20857	2357NA	20721
H9.....	21222	891	20708	3057	20722
H10.....	21057	893	20858	3057NA	20723
H11.....	21163	906	20709	3157	20726
H13.....	21058	912	20710	3157NA	20727
HB1	20778	916	20711	3457	20728
HB5	20781	916NA	20712	3457NA	20729
24NA	20702	921	20713	3496	20730
57	20703	1156	19608	3497	20731
89	20705	1156NA	20714	7440	20732
168	20706	1157NA	19610	7440NA	21031
194NA	19612	1893	20715	9004	20778
211-2	20707	1895	20716	9007	20781
880	20854	2040	20717	9008	21058
881	20855	2057	20718	9145	21057
885	20856	2357	20720		

PUSH BUTTON SWITCH
Heavy Duty Construction

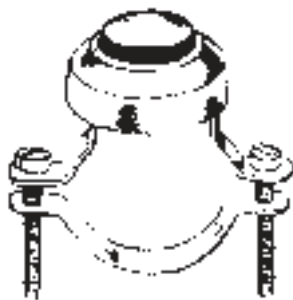

12078

Horn Button

UNIT PACKAGE: 1

PUSH-PULL SWITCHES

Not Actual Size



13552

Marine Switch
3 Position "Off-On-On"
First 'On' position energizes one circuit. In second "On" position both circuits are energized.
Mounting stem 1-1/4" long. 3/8" diameter. Brass hex back-up nut, brass washer, chrome plated brass face nut and chrome plated knob.
15 Amps @ 12 Volts

UNIT PACKAGE: 1

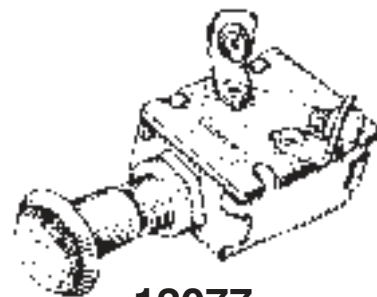

12077

Push-Pull Switch
Heavy duty. 2 position "Off-On" switch w/2 Screw Terminals.

25 Amps @ 6 Volts
15 Amps @ 12 Volts

UNIT PACKAGE: 1

TOGGLE & ROCKER SWITCHES

13555



Toggle Switch
Rating: 35 Amps @ 6 Volts
20 Amps @ 12 Volts
S.P. S.T. "Off-On". All brass
Mounting stem 3/8" long. 7/16" diameter with 7/16" x 28 threads.

UNIT PACKAGE: 1

13630



S.P. S.T. Toggle Switch -"Off-On"
Phenolic housing. Mounting stem 15/32" long; 15/32" diameter.
2 screw terminals. Bat handle
Rating: 15 Amps 125 Volts AC
10 Amps 250 Volts AC
3/4 HP 120-240 Volts AC

UNIT PACKAGE: 1

13629



S.P. S.T. Toggle Switch -"Off-On"
Two 6" Wire Leads. With nickel plated "Off-On" indicator plate assembled. Mounting stem 3/8" long. 15/32" diameter. Bat handle.
Rating: 15 Amps 12 Volts DC
6 Amps 125 Volts AC

UNIT PACKAGE: 1

13632

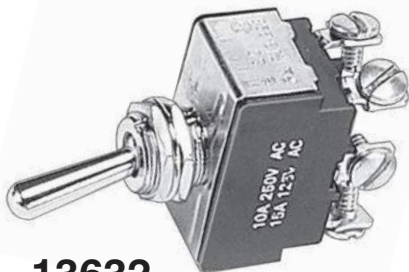

D.P. D.T. Toggle Switch
"On-Off-On"
Phenolic housing. Mounting stem 15/32" long, 15/32" diameter.
6 screw terminals
Rating: 15 Amps 125 Volts AC
10 Amps 250 Volts AC
3/4 HP 120-240 Volts AC

UNIT PACKAGE: 1

13631



S.P. D.T. Toggle Switch
"On-Off-On"
Phenolic Housing.
Mounting stem 15/32" long.
15/32" Diameter. 3 Screw Terminals. Bat handle.
Rating:
15 Amps 125 Volts AC
10 Amps 250 Volts AC
3/4 HP 120-240 Volts AC

UNIT PACKAGE: 1

12076



Heavy Duty Toggle Switch
2 position "On-Off"
For 35 Amp. 6-12 Volt DC. 15/32" Stem Diameter. Low Voltage -High Amp Application. Chrome Plated Handle.

UNIT PACKAGE: 1

Sec. 12

TOGGLE & ROCKER SWITCHES

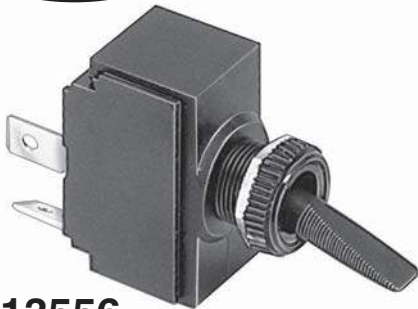

13556

Toggle Switch
2 positions "On-Off"
For lights, blower, pump, etc.
Black plastic paddle and locking ring with level seal and knurled cap nut. Sealed to resist water penetration. Fits panels up to 1/4" thick; requires 15/32" mounting hole. Rated 20 Amps @ 12 Volts D.C. and has 1/4" spade terminals

UNIT PACKAGE: 1



13514

S.P. D.T. Toggle Switch
"On-Off-On" Heavy Duty 3 Position
With 3 blade terminals. Black molded. Bat handle. Spring loaded for positive snap action. Includes bezel nut and collar. Fits in 1/2" diameter hole. Rated: 16 Amps @12 Volts.

UNIT PACKAGE: 1



Illuminated Toggle Switches

2 Position "Off-On". Handle illuminated in 'On' position. With bezel nut and back-up collar for mounting in 1/2" hole. Rating: 20 Amps @ 12 Volts

Part No. Color

- | | |
|--------------|--------------------------|
| 13523 | Red illuminated toggle |
| 13524 | Green illuminated toggle |
| 12236 | Amber illuminated toggle |

UNIT PACKAGE: 1

Illuminated Rocker Switches

2 Position "Off-On".
Rocker illuminated in 'On' position.
Snaps into 1-1/8" x 7/16" rectangular hole.
10 Amps. @ 12 Volts

Terminal Coding:

- 1 -Accessory
- 2 -Ground
- 3 -Power



Auveco
Part No. Color

- | | |
|--------------|-------------------------------|
| 12234 |Red illuminated rocker |
| 13529 |Green illuminated rocker |
| 13530 |Amber illuminated rocker |
| 13531 |Blue illuminated rocker |

UNIT PACKAGE: 1



13528

Non-illuminated Rocker Switch
2 position "Off-On". Fits 1-1/8" x 7/16"
rectangular hole. Rated 20 Amps @ 12 Volts.

UNIT PACKAGE: 1



Not Actual Size

12233

Illuminated Toggle Switch Mounting Panel
for use with Auveco Part No. 12234, 13529, 13530 & 13531. 1-1/8" x 7/16" Rectangular Hole.

UNIT PACKAGE: 1



12235

Illuminated toggle mounting panel
1/2" Hole Diameter

UNIT PACKAGE: 1

Indicator Lamps

Has wire leads for easy installation.
Mounts into 1/2" hole. 12 Volt application.

Installs in Auveco Mounting
Panel 12235

Auveco
Part No. Color

20477	With Red Lens
13520	With Green Lens
13521	With Amber Lens
13522	With Blue Lens

UNIT PACKAGE: 1



WIRE LOOM CLIPS
(ILLUSTRATIONS ACTUAL SIZE)



1340

Wire Loom Clips
1/4" Clamping Dia.

UNIT PACKAGE: 100



14388
(145525)

Heavy Duty Frame Wiring Clip
3/16" Clamping Diameter
Fits panels from .030"-.230"

UNIT PACKAGE: 50



1341

Wire Loom Clips
3/16" Clamping Dia.

UNIT PACKAGE: 100



9864

(372741-S100)
General Purpose Wire Loom Clip

UNIT PACKAGE: 100



3758

Wire Loom Clips
3/8" Clamping Dia.

UNIT PACKAGE: 100

Remember....
All Items In This Catalog
Are Available In Bulk
Call For A Cost Savings Quote



Nylon Cable Clips

Auveco Part No.	Cable Size	Screw Size	Unit Pkg.
13939	3/16"	#8-10	50
13941	5/16"	#8-10	50
13944	1/2"	#8-10	50

Nylon Tubing & Hose Clips
Adhesive Backed



Auveco Part No.	Unit Range	Pkg.
10057	5/32" to 1/4".....	10
10058	5/16" to 1/2".....	10
10059	9/16" to 3/4".....	10



13937
Nylon Spring Clip
Width: 3/8"
Overall Length: 1-5/16"
Thickness: .060
Use w/#8 Screw
UNIT PACKAGE: 50

Cable Clips For Co-Ax Cable

Polyethylene clips with corrosion resistant galvanized steel nail.

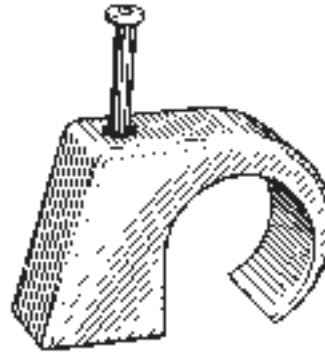

15854
3/16"-9/32" Cable Dia.
Nail Length: 1"
UNIT PACKAGE: 50

Strain-Relief Cable Connector

Reliable, liquid-tight, nylon strain-relief cable connector for quick and easy installation. They do not have to be disassembled before using. Simply insert a cable into the connector, tighten the cap nut and the cable is automatically fixed, centered, sealed and strain relieved.

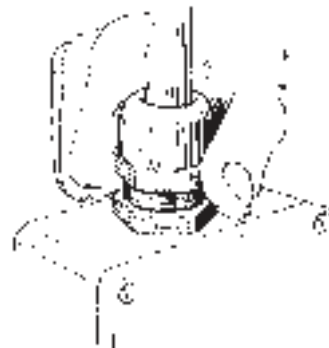
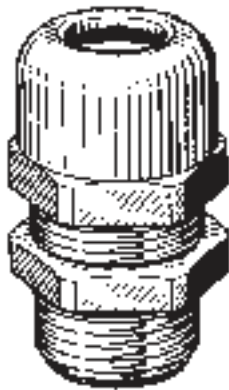

Auveco Part No.	Wire Dia.	Thread	Thread Length (Bottom)	Hex	Unit Pkg.
15851	.236" - .472"	1/2" NPT	.512"	.945"	5

ROUTING CLIPS

Wire Loom Routing Clips

Black Nylon routing clips for wire loom (also called split flexible tubing, convoluted conduit or wiring harness).

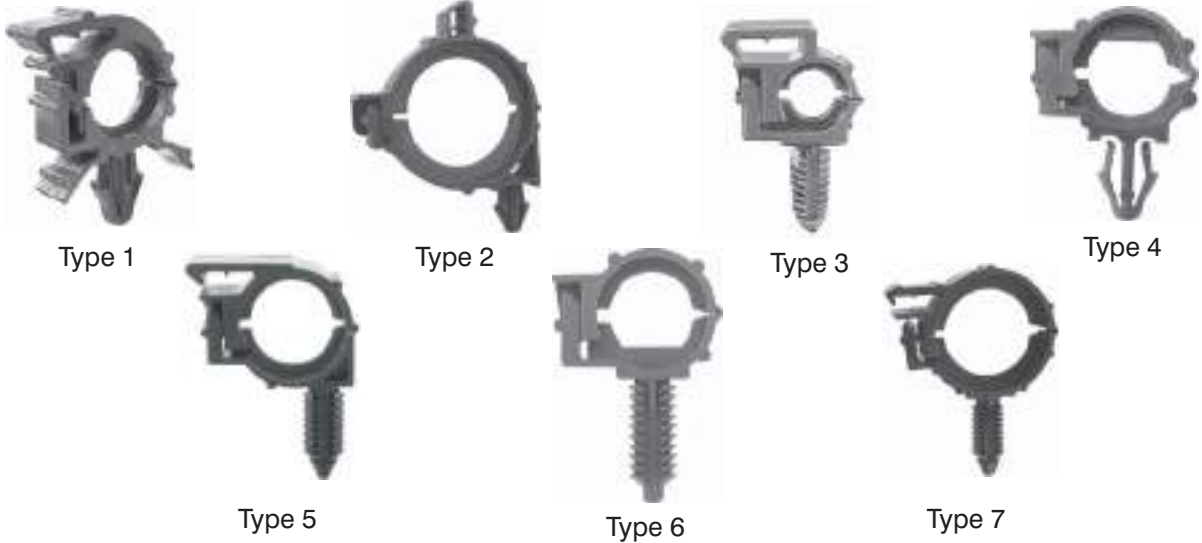

Auveco Part No.	Type	For Conduit Size.		GM No.	Unit Pkg.
		I.D.	O.D.		
19440	3	1/4"	3/8"	12040984	15
19795	4	1/4"	3/8"	12015631	15
14544	1	11/32"	1/2"	8911473	25
20397*	6	10mm	13mm	12160858	15
20471	4	10mm	13mm	8905794	15
14545	1	13/32"	19/32"	8911497	25
14546	1	1/2"	11/16"	8911472	25
19851	5	1/2"	11/16"	12040983	15
14547	1	3/4"	1"	3816659, 8917320	25
20665	7	19mm	24mm	12160374	15
16941	2	1"	1-9/32"	12015983	25

*Gray Nylon

Routing Clips



A quick, economical method of fastening wires, tubes, hoses or rods from 1/4" to 1" diameter to metal, plastic or any other surface ranging from 1/32" to 1/8" thickness. Clips are molded of durable black nylon plastic. They snap into 1/4" diameter holes and are held firmly in place by flexible "snubber tips" which compensate for variation in wall thickness.

Auveco Part No.	Tube/Hose/Wire Outside Diameter	Clip Overall Height	Clip Height Above Panel	Unit Pkg.
14529	1/4"	27/32"	7/16"	25
14530	3/8"	29/32"	15/32"	25
14531	1/2"	1-1/16"	5/8"	25
14532	5/8"	1-3/16"	3/4"	25
14533	3/4"	1-5/16"	7/8"	25

Sec. 12

CABLE & HARNESS STRAPS



8550

2-1/4" Long, Black Nylon

UNIT PACKAGE: 25



8272

2-3/4" Long, For 1/4" Hole In .093" Thick Metal
Black Nylon

UNIT PACKAGE: 50



8273

2-3/4" Long, For 1/4" Hole In 115" Thick Metal
Black Nylon

UNIT PACKAGE: 50



5853

(GM: 4000305)
2-7/8" Long,
Natural Nylon

UNIT PACKAGE: 50



3690

3-1/2" Long, Natural Nylon

UNIT PACKAGE: 100



9115

4" Long, Black Nylon

UNIT PACKAGE: 50

14376

(Mazda: 9928-90-753)



Releasable, 110mm (4-3/8") Long, Max. Bundle Dia: 25mm (1"), Fits Into 7mm Hole, Black Nylon

UNIT PACKAGE: 15



20654

(Mercedes: 001-997-42-90)

120mm (4-3/4") Long, Fits Into 8mm Hole, Black Nylon

UNIT PACKAGE: 10



5879

5" Long, Natural Nylon

UNIT PACKAGE: 25



14284

(Honda: 90669-671-0000, 90669-671-0030; Toyota: 90463-10337)

110mm (5-5/16") Long, Max. Bundle Dia: 23mm (7/8"), Fits Into 6mm Hole, Aqua Nylon

UNIT PACKAGE: 15



14298

(Honda: 90672-SA0-0030; Mazda: 9928-91-053)

Releasable, 140mm (5-1/2") Long, Max. Bundle Dia: 30mm (1-5/32"), Fits Into 7mm Hole, Black Nylon

UNIT PACKAGE: 25

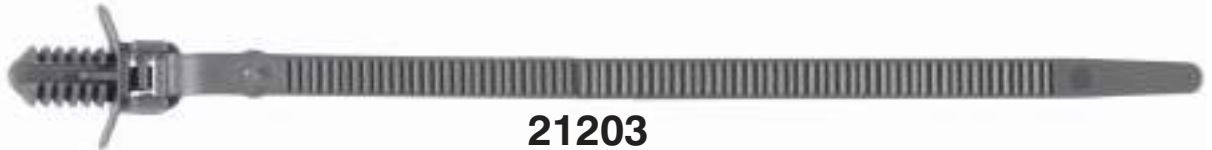

21203

155mm (6-1/8") Long, Max. Bundle Dia: 30mm (1-3/16"), Fits Into 6.3mm (1/4") Hole, Gray Nylon

UNIT PACKAGE: 25

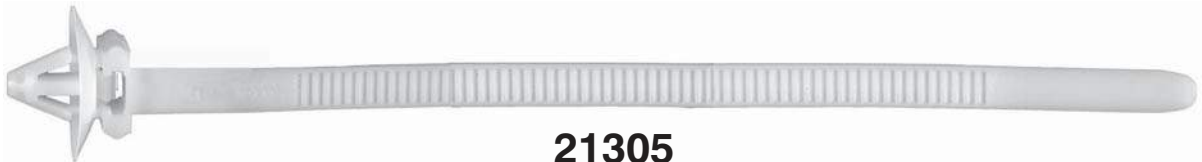

21305

156mm (6-1/8") Long, Max. Bundle Dia: 40mm (1-9/16"), Fits Into 6.3mm (1/4") Hole, Natural Nylon

UNIT PACKAGE: 25



20655

(Mercedes: 114-997-02-90)

160mm (6-3/8") Long, Fits Into 8mm (5/16") Hole, Black Nylon

UNIT PACKAGE: 10



21355

160mm (6-3/8") Long, Max. Bundle Dia: 36mm (1-13/32"), Fits Into 7mm Hole, Black Nylon

UNIT PACKAGE: 25



10649

(GM: 3816659, 19130464)

6-1/2" Long, Black Nylon

UNIT PACKAGE: 10



Not Actual Size

21553

(Toyota: 82711-12200)

170mm (6-3/4") Long, Max. Bundle Dia: 40mm (1-9/16"), Fits Into 13mm (1/2") Hole, Black Nylon

UNIT PACKAGE: 25



Not Actual Size

21310

174MM (6-15/16") Long, Max. Bundle Dia: 40mm (1-9/16"), Fits Into 13mm (1/2") Hole, Black Nylon

UNIT PACKAGE: 25



Not Actual Size

20380

200mm (8") Long, Max. Bundle Dia: 44mm (1-3/4"), Fits Into 6.3mm (1/4") Hole, Black Nylon

UNIT PACKAGE: 25

Not Actual Size



21259

(Nissan: 24225-89960)

200mm (8") Long, Max. Bundle Dia: 55mm (2-3/16"), Fits Into 8mm (5/16") Hole, Black Nylon

UNIT PACKAGE: 25

Self-Clamping Natural Nylon Straps (Reusable)



Auveco Part No.	Tensile Strength	Strap Length	Max Bundle Dia.	Width	Unit Pkg.
10217	18 lb.	3-7/8"	3/4"	3/32"	10
9636*	50 lb.	6-5/8"	1-3/4"	3/16"	10
9637	50 lb.	14-7/8"	4"	3/16"	10
10218	120 lb.	14-1/2"	4"	9/32"	10

*Black Nylon

Black Nylon Cable Ties Self Clamping



Auveco Part No.	Tensile Strength	Length	Width	Unit Pkg.
15144	18 lb.	4"	3/32"	100
15196	18 lb.	4"	3/32"	1000
15145	30 lb.	5-1/2"	1/8"	100
15197	30 lb.	5-1/2"	1/8"	1000
15146	50 lb.	7"	3/16"	50
15198	50 lb.	7"	3/16"	1000
15147	50 lb.	11"	3/16"	50
15199	50 lb.	11"	3/16"	500
15753	50 lb.	14"	3/16"	25
15148	120 lb.	14"	5/16"	25
15200	120 lb.	14"	5/16"	500

Natural Nylon Cable Ties Self Clamping



Auveco Part No.	Tensile Strength	Length	Width	Unit Pkg.
11953	18 lb.	3"	3/32"	50
11954	18 lb.	4"	3/32"	50
14836	18 lb.	4"	3/32"	100
15188	18 lb.	4"	3/32"	1000
11955	30 lb.	5"	1/8"	50
14837	30 lb.	5"	1/8"	100
15189	30 lb.	5"	1/8"	1000
11956	50 lb.	7"	5/32"	25
14838	50 lb.	7"	5/32"	50
15190	50 lb.	7"	5/32"	1000
11957	50 lb.	11"	5/32"	25
14839	50 lb.	11"	5/32"	50
15191	50 lb.	11"	5/32"	500
15754	50 lb.	14"	5/32"	25
11958	120 lb.	14"	9/32"	10
14840	120 lb.	14"	9/32"	25
15192	120 lb.	14"	9/32"	500

Black Nylon Cable Ties Self-Clamping With Mounting Hole



Auveco Part No.	Tensile Strength	Length	Screw Hole Size	Width	Unit Pkg.
15150	50 lb.	7-1/2"	#10	3/16"	50
15202	50 lb.	7-1/2"	#10	3/16"	250
15151	120 lb.	14-3/4"	#14	5/16"	25
15203	120 lb.	14-3/4"	#14	5/16"	200

Natural Nylon Cable Ties Self-Clamping With Mounting Hole



Auveco Part No.	Tensile Strength	Length	Screw Hole Size	Width	Unit Pkg.
11961	50 lb.	7"	#10	5/32"	50
15194	50 lb.	7"	#10	5/32"	250
11963	120 lb.	13"	#14	9/32"	10
15195	120 lb.	13"	#14	9/32"	100

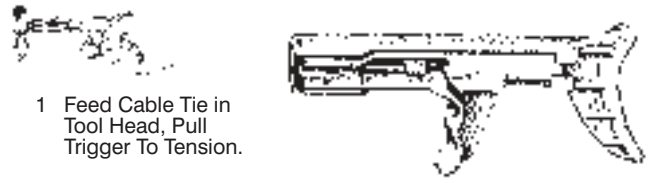

1 Feed Cable Tie in Tool Head, Pull Trigger To Tension.

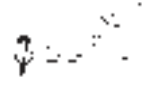

2 Hold Trigger Tension And Twist Tool 1/2 Turn

14568

Cable Tie Tool

A light-weight, durable hand tool that's perfect for installing cable ties. The tool works on 18 pound, 30 pound, 40 pound, and 50 pound tensile rated cable ties. Measures 6-1/4" long. Made of rugged plastic.

UNIT PACKAGE: 1



Uses a #6 flat head screw or 1/8" flat head rivet. Features a 4 way insertion and accepts 18, 30, and 50 pound cable ties. 1" x 1" Adhesive backing

12361
Natural Nylon

16001
Black Nylon

UNIT PKG: 10

UNIT PKG: 10

Sec. 13

OIL DRAIN PLUG GASKETS



Steel With Rubber Seal Oil Drain Plug Gaskets

Auveco Part No.	I.D.	O.D.	Thick-ness	Unit Pkg.
16026	1/2"	1"	3/64"	5
18299	14mm	25mm	1mm	10
18931	16mm	24mm	2mm	10
18932	18mm	27mm	2mm	10



Oil Drain Plug Gaskets

Auveco Part No.	I.D.	O.D.	Thick-ness	Mat.	Unit Pkg.
19538	1/2"	3/4"	5/64"	Bk. Fibre	50
8277	1/2"	3/4"	3/32"	Nylon	25
15918	1/2"	7/8"	1/16"	Copper	25
19590	1/2"	7/8"	1/16"	Aluminum	25
16996	1/2"	15/16"	1/16"	Nylon	25
18019	1/2"	15/16"	5/64"	Fibre	50
19539	9/16"	13/16"	5/64"	BK. Fibre	50
8281	9/16"	13/16"	3/32"	Nylon	25
15919	9/16"	13/16"	3/32"	Copper	25
8278	5/8"	1"	3/32"	Nylon	25
18021	3/4"	1"	1/16"	Copper	25
8279	3/4"	1-1/16"	3/32"	Nylon	25
18849	12mm	21mm	1.8mm	Steel*	5
16680	12mm	22mm	1.5mm	Nylon	50
19591	12mm	22mm	1.5mm	Copper	15
19601	12mm	22mm	1.5mm	Aluminum	50
18726	12mm	22mm	2mm	Bk. Fibre	50
17628	12mm	22mm	2.5mm	Bk. Fibre	25
19621	14mm	20mm	1mm	Aluminum	50
20454	14mm	20mm	1.5mm	Copper	15
19592	14mm	24mm	1.5mm	Copper	15
16956	14mm	22mm	2mm	Aluminum	50
16681	14mm	24mm	1.5mm	Nylon	50
16682	14mm	24mm	2mm	Gray Fibre	50
19604	16mm	22mm	1.5mm	Copper	10
19603	16.4mm	27mm	2mm	Bk Fibre	50
16683	16.5mm	27mm	1.5mm	Nylon	50
20462	18mm	24mm	1.2mm	Aluminum	25
16955	18mm	25.5mm	2mm	Aluminum	50
16684	18mm	29mm	1.5mm	Nylon	50
19605	18mm	26mm	1.5mm	Copper	10
18829	18mm	29mm	1.5mm	Grn Fibre	25
19139	20mm	26mm	2mm	Steel	15
16685	20mm	28mm	1.5mm	Nylon	50
19593	20mm	25mm	1.6mm	Copper	10
18830	20mm	28mm	1.5mm	Grn Fibre	25
21647	20mm	28mm	2mm	Bk. Fibre	25
21178	20mm	28.5mm	1.6mm	Aluminum	25
21648	23mm	29mm	2mm	Bk. Fibre	25
21649	24mm	30mm	1.8mm	Aluminum	10
18020	25.5mm	35mm	2mm	Bk Fibre	50

* Teflon coated steel



Oil Drain Plug Rubber Gaskets

21180

I.D. 11mm
O.D. 18mm

Replacement Gasket
For Auveco No. 20347
Oil Drain Plugs
Ford 1993 - On

UNIT PACKAGE: 10

18665

I.D.: 11mm
O.D.: 21mm

Replacement Gasket
For Auveco No.
18663,
18664 & 20372
GM 12mm-1.75
Oil Drain Plugs

UNIT PACKAGE: 10

20896

(Not Supplied By O.E.M.)

I.D.: 13mm
O.D.: 19mm

Replacement Gasket For
Auveco No. 19773
M14-1.5 Oil Drain Plugs

UNIT PACKAGE: 10

21179

I.D. 11mm
O.D. 19mm

Replacement Gasket
For Auveco No. 21047
Oil Drain Plugs
GM 1985 - On

UNIT PACKAGE: 10

19630

I.D.: 11mm
O.D.: 25mm

Replacement Gasket
For Auveco. No.
18023
GM 12mm-1.75
Oil Drain Plugs

UNIT PACKAGE: 10

20453

(F5TZ-6734-BA)

I.D.: 13mm, O.D.: 22mm
Replacement Gasket

For Auveco
No. 19279
M14-1.5 Oil Drain Plugs

UNIT PACKAGE: 10

Oil Drain Plug Crushable Gaskets



Auveco Part No.	I.D.	O.D.	Thick-ness	Material	Unit Pkg.
19545	1/2"	3/4"	5/64"	Copper	10
17261	12mm	18mm	2mm	Copper	10
21258	12mm	18mm	3mm	Copper	10
19007	14mm	19mm	2mm	Steel	10
17262	14mm	20mm	2mm	Copper	10
21677	16mm	21mm	2.5mm	Steel	10
17263	16mm	22mm	2mm	Copper	10
17264	18mm	24mm	2mm	Copper	10
21116	18mm	24mm	2.5mm	Steel	10
17265	20mm	26mm	2mm	Copper	10

OIL & TRANSMISSION DRAIN PLUGS (WITH GASKETS)

Sec. 13

14196

Plain

Thread: 1/2"-20

Hex: 7/8"

Length Under Head: 1/2"

Fits the following 1/2"-20 applications:

AMC

6 & 8 Cyl. All 64-On

Buick

4, 6 & 8 Cyl. All [Exc. 2.5 (151), 3.0, 4.3, 4.9 (301 Eng.)] 59-On

Cadillac

6 & 8 Cyl. All (Exc. 4.1 Eng) 66-On

Chevrolet (Includes Light Truck)

4, 6 & 8 Cyl. All [Exc. 1.8 (diesel), 2.5 (151), 4.3 (diesel) Eng.] 28-On

Chrysler Corp.

6 & 8 Cyl. All 62-On

Ford Motor Co.

4, 6 & 8 Cyl. All (Exc. 98, 122, 140, 171 Eng) 57-On

GMC (Light Truck) 6 & 8 Cyl. All 39-On

Oldsmobile

4, 6 & 8 Cyl. All [Exc. 2.5 (151), 3.0, 4.3, (diesel), 4.3S, 4.9T (301)] 61-On

Pontiac

4, 6, & 8 Cyl. All [Exc. 1.8 (diesel), 2.5 (151), 4.3 (diesel), 4.3S, 4.9T (301)] 60-On

UNIT PACKAGE: 10



18373

(6034376)

Plain With Rubber Washer Face Gasket

Thread: 1/2"-20

Hex: 5/8"

Length Under Head: 13/16"

Rubber Gasket O.D.: 1-3/32"

Fits the following applications:

Chrysler

UNIT PACKAGE: 2



18022

(948187-0)

Zinc

Thread: 3/4"-16

Hex: 1"

Length Under Head: 1/2"

Fits the following applications:

Volvo: 4 Cyl.

UNIT PACKAGE: 2



21665

(BC3Z-6730-A)

Yellow Plastic With Rubber Gasket

Diameter: 13/16"

3/8" Square Drive

Overall Length: 1-13/16"

Fits The Following Applications:

Ford F250 & F350 with 6.7L Powerstroke 2011 - On

UNIT PACKAGE: 1



19318

(Jeep: 83504041;

Lexus: 90341-10006,

90341-10012)

Zinc & Yellow

Thread: M10-1.5; Hex: 14mm

Length Under Head: 9mm

Fits the following transmission applications:

Jeep Cherokee, Comanche & XJ 1991-On

Lexus GS300, LS400 & SC400 1991-On

UNIT PACKAGE: 2



20807

(F81Z-6730-AA)

Plain With Rubber Washer Face Gasket

Thread: M10-1.5

Hex: 13mm

Length Under Head: 15mm

Rubber Gasket O.D.: 28mm

Fits the following 4R100 transmission applications:

Ford E150-450, F150-450

Excursion & Expedition

1980 - On

UNIT PACKAGE: 1



15527

Zinc

Thread M12-1.25

Hex: 14mm

Length Under Head: 11mm

Washer Head O.D.: 20mm

Fits the Following M12-1.25 applications:

Nissan

Sentra, Stanza & Pulsar w/ FWD 1982-On

UNIT PACKAGE: 5



19589

Zinc

Thread M12-1.5

Hex: 13mm

Length Under Head: 12mm

Washer Head O.D.: 17mm

Fits The Following Applications:

BMW & Mercedes

UNIT PACKAGE: 5



19130

(3921988)

Plain

Thread: 1/2"-20

Hex: 9/16"

Length Under Head:

13/16"

Washer Head O.D.: 7/8"

Buick

4, 6 & 8 Cyl. All [Exc. 2.5(151) 3.0, 4.3, 4.9 (301 Eng.)] 59-On

Cadillac

6 & 8 Cyl. All (Exc. 4.1 Eng) 66-On

Chevrolet (Inc. GMC Light Truck)

4, 6 & 8 Cyl. All [Exc. 1.8 (diesel), 2.5 (151), 4.3 (diesel) Eng.] 28-On

Oldsmobile

4, 6 & 8 Cyl. All [Exc. 1.8 (diesel), 2.5 (151), 3.0, 4.3, (diesel), 4.3S, 4.9T (301)Eng.] 61-On

Pontiac

4, 6 & 8 Cyl. All [Exc. 1.8 (diesel), 2.5 (151), 4.3 (diesel), 4.3S, 4.9T (301)Eng.] 60-On

UNIT PACKAGE: 15



21293

(11128-01M0B)

Zinc & Yellow

Thread: M12-1.25

Hex: 14mm

Length Under Head: 12mm

Washer Head O.D.: 32mm

Fits the following applications:

Nissan Sentra & 350Z and Infiniti 1992 - On

UNIT PACKAGE: 2

Sec. 13

OIL & TRANSMISSION DRAIN PLUGS (WITH GAS-KETS)

19588

Zinc

Thread: M12-1.25
Hex: 14mm
Length Under Head: 17mm
Washer Head O.D.: 20mm

Fits The Following Applications:
Nissan

UNIT PACKAGE: 5



21093

(24233099)

Zinc With
Rubber Gasket

Thread: M12-1.75
Hex: 15mm
Length Under Head: 20mm
Washer Head O.D.: 32mm

Fits the following applications:
4L80-E Transmissions on **Chevrolet**
2 WD Full Size Vans & Pickup
Trucks 1997 - On

UNIT PACKAGE: 2



21047

(GM: 3536964,
3538469, 11519408,
11562588, 24100042;
Isuzu: 8-11519-408-0)
Zinc With
Rubber Gasket

Thread: M12-1.75
Hex: 15mm
Length Under Head: 25mm
Washer Head O.D.: 26mm

Fits the following applications:
GM 2.2 (4), 3.1 (M), 3.8 (K), 3.8 (1),
2.3, 4.9 & 6.0L Eng. 1985 - On

UNIT PACKAGE: 2



21353

(90009-PH1-000,
90009-PH6-000)
Zinc & Yellow

Thread: M14-1.5
Hex: 17mm
Length Under Head: 10mm
Washer Head: 24mm

Fits the following applications:
Acura & Honda

UNIT PACKAGE: 5



18374

(F5AZ-6730)

Plain With Rubber
Washer Face Gasket

Thread: M12-1.75
Hex: 15mm
Length Under Head: 21mm
Rubber Gasket O.D.: 28mm

Fits the following applications:
Ford 2.5, 3.0 & 4.6 Eng.
With Modular & Aluminum Pans

UNIT PACKAGE: 2



21352

(N90288901)
Black Zinc

Thread: M14-1.5
Hex: 19mm
Length Under Head: 14mm

Fits the following applications:
Volkswagen

UNIT PACKAGE: 2



21354

(6507741-AA)

Zinc With
Rubber Gasket

Thread: M14-1.5
Hex: 17mm
Length Under
Head: 21mm
Washer Hd O.D.: 29mm
Fits the following application:
Chrysler

UNIT PACKAGE: 2



21135

(21512-23001)
Dacromet

Thread: M14-1.5
Hex: 17mm
Length Under
Head: 17mm
Washer Head O.D.: 22.5mm

Fits the following applications:
Hyundai & Kia 1995 - On

UNIT PACKAGE: 2



18023

(21006725)
Black Zinc
With Rubber
Gasket

Thread: M12-1.75
Hex: 14mm
Length Under Head: 19mm
Rubber Gasket O.D.: 31mm

Fits the following application:
GM: Saturn

UNIT PACKAGE: 2



20347

(YS4Z-6730AA)

Plain With
Rubber Gasket

Thread: M12-1.75
Hex: 13mm
Length Under Head: 25mm
Washer Head O.D.: 26mm
Fits the following applications:
Ford 1999 - 93

UNIT PACKAGE: 2



14677

Zinc

Thread: M12-1.75
Hex: 15mm
Length Under
Head: 26mm
Washer Head O.D.: 22mm

Fits the following
M12-1.75 applications:
Buick
4 Cyl. 151 (2.5) Eng. 80-On
6 Cyl. 3.0, 4.3 (Diesel) Eng. 82-On
8 Cyl. 4.3, 4.9 Eng. 81-77

Cadillac
8 Cyl. 4.1 Eng. 82-On

Chevrolet
4 Cyl. 151 (2.5) Eng. 78-On
6 Cyl. 4.3 (Diesel) Eng. 82-On

Oldsmobile
4 Cyl. 151 (2.5) Eng. 78-On
6 Cyl. 3.0, 4.3 (Diesel) Eng. 82-On
8 Cyl. 4.3S, 4.9T (301) Eng. 80-79

Pontiac
4 Cyl. 151 (2.5) Eng. 77-On
6 Cyl. 4.3 (Diesel) Eng. 82-On
8 Cyl. 4.3S, 4.9T (301) Eng. 81-77

UNIT PACKAGE: 5



OIL & TRANSMISSION DRAIN PLUGS (WITH GASKETS) **Sec. 13**

18024

Zinc

Thread: M14-1.25
Hex: 13mm
Length Under Head: 16mm
Washer Head O.D.: 23mm

Fits the following applications:
Jeep

UNIT PACKAGE: 5



18025

(E9DZ-6730-B)
Zinc

Thread: M14-1.5
Hex 13mm
Length Under Head: 16mm
Washer Head O.D.: 23mm

Fits the following applications:
Ford: Escort

UNIT PACKAGE: 5



19773

(F75Z-6730-BA)
Phosphate With
Rubber Gasket

Thread: M14-1.5
Hex: 16mm
Lgth Under Hd: 20mm
Washer Hd O.D.: 28mm

Fits the following applications:
Ford Vans & Trucks
With 6.8L Eng. 2000-96

UNIT PACKAGE: 1



16308

Zinc

Thread: M14-1.5
Hex: 16mm
Length Under Head: 11mm
Washer Head O.D.: 25mm

Fits The Following
M14-1.5 Applications:
Chrysler Imports 83-On

Honda 83-On

Isuzu 87-On

Mazda 72-On

Spectrum 88-On

Sprint 88-On

VW-Audi 74-On

UNIT PACKAGE: 5



18375

(6503433)

Plain With
Rubber Washer
Face Gasket

Thread: M14-1.50
Hex: 17mm
Length Under Head: 18mm
Rubber Gasket O.D.: 28mm

Fits the following applications:
Chrysler 1.5 & 2.0 Eng.

UNIT PACKAGE: 2



19279

(F6TZ-6730BA)
Phosphate
With Rubber Gasket

Thread M14-1.50
Hex: 13mm
Lgth Under Hd: 20mm
Washer Hd O.D.: 28mm

Fits the following applications:
Chrysler with 2.0(F), 2.4(B,G,8),
2.7(R,T), 3.3(G,S,3) & 3.5(G,4)
Eng. 2000 - On
Ford Aerostar, Explorer & Ranger
6 Cyl. 4 Ltr. Eng. 1996-On

UNIT PACKAGE: 2



20746

(N90813201)

Zinc With
Sems® Gasket

Thread: M14-1.5
Hex: 19mm
Length Under Head: 20mm
Sems® Washer O.D.: 20mm

Fits the following applications:
Audi Cabriolet & Quattro with 1.8,
1.9, 2.0, 2.7, 2.8, & 3.0 Eng.
VW Beetle, Eurovan, Golf, Jetta,
Passat & Touareg with 1.8, 1.9, 2.0,
2.8, 3.2 & 4.0 Eng.

UNIT PACKAGE: 2



14678

Zinc

Thread M14-1.5
Hex 16mm
Lgth Under Hd: 20mm
Washer Hd O.D.: 25mm

Fits the following
M14-1.5 applications:

AMC

4 Cyl. VW 121 Eng. 79-77

Chevrolet

4 Cyl. 1.8 (Diesel) Eng. 81-On

Chrysler Corp (Exc. Imports)

4 Cyl. All 78-On

Chrysler Corp. Imports

4 Cyl. All 83-On

4 Cyl. K & W Engines
(built after 10-81) 82

Ford Motor Co.

4 & 6 Cyl. 98, 122, 140, 171 Eng.
73-On

Honda 4 Cyl. Prelude 83-On

Mazda 4 Cyl. All 72-On

Pontiac 4 Cyl. 1.8 (Diesel) 83-On

Volkswagen

4 Cyl. All (Water Cooled Engine)
74-On

UNIT PACKAGE: 5



20426

(90009-PY3-000)

Zinc & Yellow
With Aluminum
Gasket

Thread: M14-1.5
Hex: 17mm
Length Under Head: 15mm
Washer Head O.D.: 24mm

Fits the following M14-1.5
Applications:

Acura & Honda 2000 - On

UNIT PACKAGE: 5



19141

(6504018)

Plain With
Rubber
Washer Face
Gasket

Thread: M14-1.50
Hex: 13mm
Length Under Head: 20mm
Rubber Gasket O.D.: 28mm

Fits the following applications:
Chrysler 2.0, 2.4, 2.7, 3.2, 3.5, 3.7 &
4.7 Eng. 2000 - On

UNIT PACKAGE: 2



21650

(55568037)

Zinc

Thread: M14-1.5
Hex: 10mm
Length Under Head: 16mm
Washer Head O.D.: 27mm

Fits the following applications:
Chevrolet Cruze & Volt 2010 - On

UNIT PACKAGE: 2





18026

(601-997-02-30)
Zinc

Thread: M14-1.5
Hex: 13mm
Length Under Head: 24mm
Washer Head O.D.: 19mm

Fits the following applications:
Mercedes: 300 Series

UNIT PACKAGE: 2



21326

(807016160,
803916010)
Zinc

Thread: M16-1.5 x 9mm
Hex 14mm
Washer Head O.D.: 24mm

Fits the following applications:
Subaru Legacy & Outback 2.5L

UNIT PACKAGE: 2

Auveco....

**The World's Largest
Supplier Of Body
Hardware & Specialty
Fasteners**



15528

Zinc

Thread M16.4-1.33 O.S.
Hex 19mm
Length Under Head: 13mm
Washer Head O.D.: 26mm

Fits the Following M16.4 O.S.
applications:
Nissan: All (Exc. Sentra, Stanza &
Pulsar w/FWD 62-On
Renault: Fuego & LeCar 80-On

UNIT PACKAGE: 5



15529

Zinc

Thread: M18-1.5
Hex: 19mm
Length Under Head: 12mm
Washer Head O.D.: 29mm

Fits the Following M18-1.5
applications:
Chrysler: All imports 70-On
Renault: LeCar 79-76
Toyota: All 75-On

UNIT PACKAGE: 5



15530

Plain

Thread: M20-1.5
Hex: 15mm
Length Under Head: 21mm
Washer Head O.D.: 29mm

Fits the Following
M20-1.5 applications:
Chevrolet Truck:
Luv 82-75

Honda:
All exc. Prelude 73-On

Subaru: All 79-On

UNIT PACKAGE: 5



21041

(028-103-059-A)
Zinc

Thread: M24-1.5
Drive: 10mm Allen
Length Under Head: 10mm
Head Diameter: 32mm

Fits the following applications:
Audi Cabriolet, A6, A8, Avant,
Quattro, RS6, S4, S6 & S8
VW Phaeton 6.0L & V8 4.2L and
Touareg 4.2L

UNIT PACKAGE: 1



18027

Zinc

Thread: M25-1.5
Hex: 24mm
Length Under Head: 13mm
Washer Head O.D.: 35mm

Fits the following applications:
Toyota

UNIT PACKAGE: 1

Magnetic Oil Drain Plugs (With Gaskets)
Zinc Plated



Type 1



Type 2



Type 3

Auveco Part No.	Type	Thread Size	Hex	Length Under Head	Finish	Unit Pkg.
19365	3	1/2"-20	3/4"	43/64"	Zinc	1
17145	1	1/2"-20 Single Oversize	3/4"	13/16"	Zinc	2
17146	1	1/2"-20 Double Oversize	3/4"	13/16"	Zinc & Yellow	2
17147	1	1/2"-20 Triple Oversize	3/4"	13/16"	Black Zinc	2
17148	2	12mm-1.75	13mm	19mm	Zinc	2

Oversize "Piggy-Back" Drain Plugs With Gasket



11782

1/2"-20 Single Oversize
Zinc

UNIT PACKAGE: 5

11783

1/2"-20 Double Oversize
Zinc & Yellow

UNIT PACKAGE: 5

Oversize Oil Pan Drain Plugs With Fibre Gaskets Self-Tapping















Metric















Standard

Auveco Part No.	Size	Finish	Unit Pkg.
19587	1/2"-20 Single Oversize	Zinc	5
18121	1/2"-20 Double Oversize	Zinc & Yellow	5
18122	1/2"-20 Triple Oversize	Black Zinc	5
8285	5/8"-18 Single Oversize	Zinc	5
8286	11/16"-20 Single Oversize	Zinc	5
8288	3/4"-16 Single Oversize	Zinc	5
8289	7/8"-14 Single Oversize	Zinc	5
19618	M12-1.25 Single Oversize	Zinc	5
20759	M12-1.50 Single Oversize	Zinc	5
19619	M12-1.75 Single Oversize	Zinc	5
19620	M14-1.50 Single Oversize	Zinc	5

GREASE FITTINGS
(Also Available In Large Bulk Quantities)

 <p>Ref. No: 1792</p> <p>1/4"-28, Straight Thread Length: 9/64" Overall Length: 1/2" Ball Check, Plated</p> <p>15055 Unit Pkg: 50 15074 Unit Pkg: 250 15075 Unit Pkg: 500 15440 Unit Pkg: 1000</p>	 <p>Ref. No: 5530</p> <p>1/4"-28, Straight Self-Tapping Overall Length: 9/16" Ball Check, Plated</p> <p>15000 Unit Pkg: 50 15068 Unit Pkg: 250 15069 Unit Pkg: 500</p>	 <p>Ref. No: 1636</p> <p>1/4"-28, 45° Thread Length: .3" Overall Length: 1" Ball Check, Plated</p> <p>15056 Unit Pkg: 25 15076 Unit Pkg: 100 15077 Unit Pkg: 250 15441 Unit Pkg: 1000</p>
 <p>Ref. No: 1641</p> <p>1/4"-28, Straight Thread Length: 7/32" Overall Length: 9/16" Ball Check, Plated</p> <p>9257 Unit Pkg: 50 15100 Unit Pkg: 250 15101 Unit Pkg: 500 15415 Unit Pkg: 1000</p>	 <p>Ref. No: 1743</p> <p>1/4" Drive Fit Straight Overall Length: 1/2" Ball Check, Plated</p> <p>15054 Unit Pkg: 25 15072 Unit Pkg: 100 15073 Unit Pkg: 250 15439 Unit Pkg: 1000</p>	 <p>Ref. No: 1665</p> <p>1/4"-28, 65° Overall Length: 25/32" Ball Check, Plated</p> <p>15053 Unit Pkg: 25 15070 Unit Pkg: 100 15071 Unit Pkg: 250 15438 Unit Pkg: 1000</p>
 <p>Ref. No: 1652</p> <p>1/4"-28 Straight Overall Length: 11/16" Ball Check, Plated</p> <p>9258 Unit Pkg: 50 15102 Unit Pkg: 250 15103 Unit Pkg: 500 15416 Unit Pkg: 1000</p>	 <p>Ref. No. 1952</p> <p>1/4" Drive Fit, Straight Overall Length: 27/64" No Check Valve Plated</p> <p>15065 Unit Pkg: 50 15094 Unit Pkg: 250 15450 Unit Pkg: 1000</p>	 <p>Ref. No: 1911</p> <p>1/4"-28, 90° Overall Length: 45/64" Ball Check, Plated</p> <p>9261 Unit Pkg: 25 15108 Unit Pkg: 100 15109 Unit Pkg: 250</p>
 <p>Ref. No. 1680</p> <p>1/4"-28, Straight Overall Length: 15/16" Ball Check, Plated</p> <p>9259 Unit Pkg: 25 15104 Unit Pkg: 100 15417 Unit Pkg: 1000</p>	 <p>Ref. No: 1637</p> <p>1/4"-28, 45° Overall Length: 29/32" Ball Check, Plated</p> <p>9260 Unit Pkg: 25 15106 Unit Pkg: 100 15107 Unit Pkg: 250 15418 Unit Pkg: 1000</p>	 <p>Ref No: 5590</p> <p>1/4"-28, 90° Self-Tapping Overall Length: 43/64" Ball Check, Plated</p> <p>19176 Unit Pkg. 25 19177 Unit Pkg. 100 19178 Unit Pkg. 250</p>

GREASE FITTINGS
(Also Available In Large Bulk Quantities)

<p>Ref No: 1610</p>  <p>1/8" Pipe, St. Overall Length: 5/8" Ball Check, Plated</p> <p>9262 Unit Pkg: 50 15110 Unit Pkg: 250 15111 Unit Pkg: 500 15420 Unit Pkg: 1000</p>	<p>Ref. No: 1688</p>  <p>1/8" Pipe, 45° Overall Length: 1" Ball Check, Plated</p> <p>9264 Unit Pkg: 25 15114 Unit Pkg: 100 15115 Unit Pkg: 250 15422 Unit Pkg: 1000</p>	<p>Ref. No: 1612</p>  <p>1/8" Pipe, 65° Overall Length: 7/8" Ball Check, Plated</p> <p>9265 Unit Pkg: 25 15116 Unit Pkg: 100 15117 Unit Pkg: 250 15423 Unit Pkg: 1000</p>
<p>Ref No: 1607</p>  <p>1/8" Pipe, St. Overall Length: 1-1/4" Ball Check, Plated</p> <p>9267 Unit Pkg: 25 15120 Unit Pkg: 100 15121 Unit Pkg: 250</p>	<p>Ref. No: 5570</p>  <p>1/8" Pipe, St. Self-Tapping Overall Length: 39/64" Ball Check, Plated Nominal Hole Size: 3/8"</p> <p>15066 Unit Pkg: 25 15096 Unit Pkg: 100 15097 Unit Pkg: 250</p>	<p>Ref. No: 1613</p>  <p>1/8" Pipe, 90° Overall Length: 53/64" Ball Check, Plated</p> <p>9266 Unit Pkg: 25 15118 Unit Pkg: 100 15119 Unit Pkg: 250 15424 Unit Pkg: 1000</p>
<p>Ref. No: 1728</p>  <p>3/16" Drive Fit, St. Overall Length: 1/2" Ball Check, Plated</p> <p>15060 Unit Pkg: 50 15084 Unit Pkg: 250 15085 Unit Pkg: 500</p>	<p>Ref. No: 1711</p>  <p>5/16"-24, Straight Overall Length: 5/8" Ball Check, Plated</p> <p>15057 Unit Pkg: 25 15078 Unit Pkg: 100 15079 Unit Pkg: 250</p>	<p>Ref. No: 1608</p>  <p>5/16" Drive Fit, St. Overall Length: 9/16" Ball Check, Plated</p> <p>15061 Unit Pkg: 50 15086 Unit Pkg: 250 15087 Unit Pkg: 500 15446 Unit Pkg: 1000</p>
<p>Ref. No: 1710</p>  <p>3/8"-24, Straight Overall Length: 5/8" Ball Check, Plated</p> <p>15058 Unit Pkg: 25 15080 Unit Pkg: 100</p>	<p>Ref. No: 1627</p>  <p>1/4" Pipe, St. Overall Length: 27/32" Ball Check, Plated</p> <p>15059 Unit Pkg: 25 15082 Unit Pkg: 100 15083 Unit Pkg: 250 15444 Unit Pkg: 1000</p>	<p>Ref. No: 1629</p>  <p>1/4" Pipe, 65° Overall Length: 1" Ball Check, Plated</p> <p>15062 Unit Pkg: 10 15088 Unit Pkg: 50 15089 Unit Pkg: 100</p>

Sec. 13

METRIC GREASE FITTINGS (Also Available In Large Bulk Quantities)



Ref No:
8601

6mm-1.00, Straight
DIN 71412
Overall Length: 14mm
Ball Check, Plated

11097	Unit Pkg:	5
15122	Unit Pkg:	50
15123	Unit Pkg:	100
15426	Unit Pkg:	1000



Ref. No:
7045

6mm-1.00, 45°
Overall Length: 22mm
Ball Check, Plated

11775	Unit Pkg:	10
15132	Unit Pkg:	50
15133	Unit Pkg:	100
15431	Unit Pkg:	1000



Ref No:
7090

6mm-1.00, 90°
Overall Length: 18mm
Ball Check, Plated

11776	Unit Pkg:	10
15134	Unit Pkg:	50
15135	Unit Pkg:	100



Ref No:
8901

8mm-1.00, Straight
DIN 71412
Overall Length: 15mm
Ball Check, Plated

11098	Unit Pkg:	5
15124	Unit Pkg:	50
15125	Unit Pkg:	100



Ref No:
7445

8mm-1.00, 45°
Overall Length: 23mm
Ball Check, Plated

11777	Unit Pkg:	10
15136	Unit Pkg:	50
15137	Unit Pkg:	100



Ref No:
7490

8mm-1.00, 90°
DIN 71412
Overall Length: 18mm
Ball Check, Plated

11099	Unit Pkg:	5
15126	Unit Pkg:	50
15127	Unit Pkg:	100



Ref No:
9201

8mm-1.25, Straight
Overall Length: 15mm
Ball Check, Plated

11778	Unit Pkg:	10
15138	Unit Pkg:	50
15139	Unit Pkg:	100
15434	Unit Pkg:	1000



Ref No:
7545

8mm-1.25, 45°
Overall Length: 23mm
Ball Check, Plated

11779	Unit Pkg:	10
15140	Unit Pkg:	50
15141	Unit Pkg:	100



Ref No:
7590

8mm-1.25, 90°
Overall Length: 18mm
Ball Check, Plated

11780	Unit Pkg:	10
15142	Unit Pkg:	50
15143	Unit Pkg:	100
15436	Unit Pkg:	1000



Ref No:
9301

10mm-1.00, Straight
DIN71412
Overall Length: 15mm
Ball Check, Plated

11100	Unit Pkg:	5
15128	Unit Pkg:	50
15129	Unit Pkg:	100



Ref No:
9345

10mm-1.00, 45°
Overall Length: 23mm
Ball Check, Plated

15067	Unit Pkg:	25
15098	Unit Pkg:	100
15099	Unit Pkg:	250



Ref No:
9390

10mm-1.00, 90°
DIN 71412
Overall Length: 19mm
Ball Check, Plated

11101	Unit Pkg:	5
15130	Unit Pkg:	50
15131	Unit Pkg:	100





Ref. No:
9501

10mm-1.5 Straight
Overall Length: 15mm
Ball Check, Plated

17555	Unit Pkg:	50
--------------	-----------	----

STAINLESS STEEL WITH BALL CHECK
303 Series Body • 420 Series Ball • 302 Series Spring

 <p>Ref. No: 8036</p> <p>6mm-1.00, Straight Overall Length: 14mm UNIT PACKAGE: 5</p>	<p style="text-align: center; font-size: 24pt;">17155</p>  <p>Ref. No: 8058</p> <p>8mm-1.00, Straight Overall Length: 15mm UNIT PACKAGE: 5</p>
---	--

4-Way Grease Fitting Tool

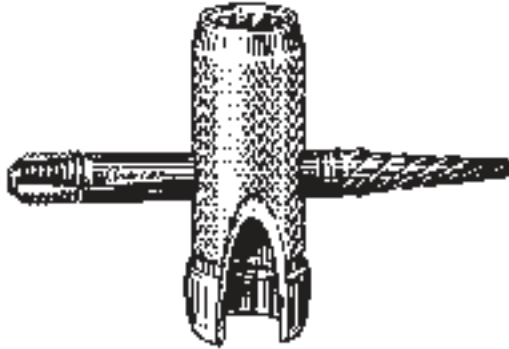

15694

For 1/8" NPT fittings. Tap repairs 1/8" NPT threads. Wrench removes 7/16" and 3/8" hex fittings and plugs. Installs new 1/8" NPT fittings. "Easy Out" removes broken fittings.

UNIT PACKAGE: 1

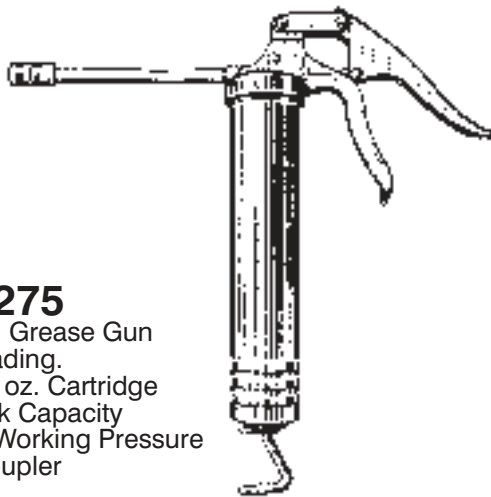

16275

One-Hand Grease Gun
3-Way Loading.
Uses 14.5 oz. Cartridge
16 oz. Bulk Capacity
2500 PSI Working Pressure
3 Claw Coupler
Blue

UNIT PACKAGE: 1

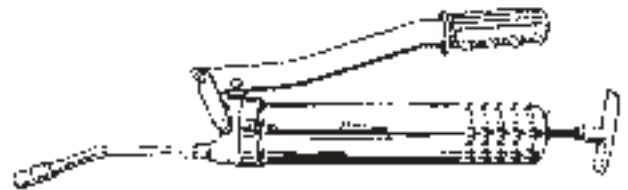

16277

Professional Grease Gun
Delivers Grease At Various Lever Openings
3-Way Loading
Uses 14.5 oz. Cartridge
16 oz. Bulk Capacity
Variable Pressure
4 Claw Coupler
Zinc With Black Rubber Grip

UNIT PACKAGE: 1

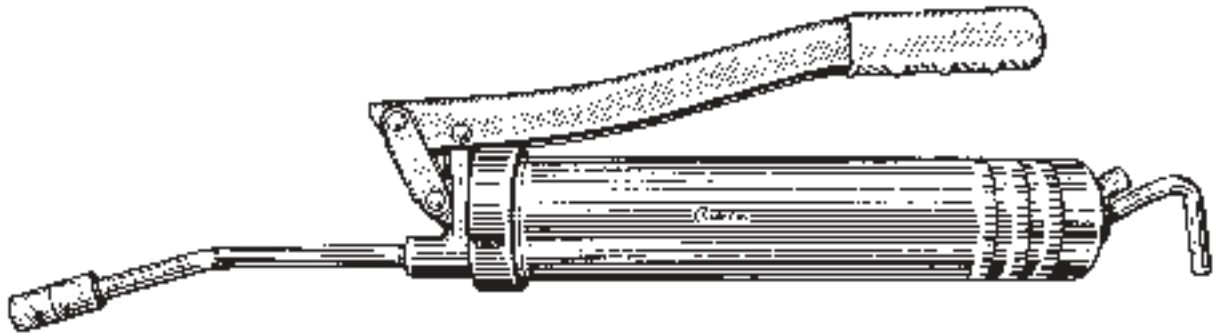

16276

Heavy Duty Grease Gun
3-Way Loading
Uses 14.5 oz. Cartridge
16 oz. Bulk Capacity
10,000 PSI Working Pressure
3 Claw Coupler
Blue With Orange Vinyl Grip

UNIT PACKAGE: 1

Sec. 13

GREASE GUN ACCESSORIES & PIPE PLUGS



15688

Grease Gun Coupler
With Ball Check

Fits 1/8" NPT Threads
For hand operated lube equipment. Working pressure:
3,000 PSI
Overall Length: 1-3/8"

UNIT PACKAGE: 1



15689

Heavy Duty
Grease Gun
Coupler
With Ball Check

Fits 1/8" NPT Threads
For hand operated lube equipment only.
Working pressure: 5,000 PSI
Overall Length: 1-7/16"

UNIT PACKAGE: 1

**Grease Gun Hoses
1/8" NPT Male Fittings**



15691

12"
3000 PSI

UNIT PKG: 1

15692

18"
3000 PSI

UNIT PKG: 1

16279

12"
5800 PSI

UNIT PKG: 1

16280

18"
5800 PSI

UNIT PKG: 1

Grease Fitting Caps

Polyethylene caps that snap over fittings to seal out dirt and moisture. Integral ring keeps cap in place during servicing.



18109

18110

18111

Black

Red

Yellow

U.P. 50

U.P. 50

U.P. 50

Socket Head Pipe Plugs

Cold Rolled Steel
Plain Finish



Hex Head Pipe Plugs

Cold Rolled Steel
Plain Finish



Auveco Part No.	O.E.M. No.	Pipe Size	Unit Pkg.
-----------------	------------	-----------	-----------

9282	GM: 94278821/8-2725
9283	GM: 4447761/4-1825
9284	GM: 4447823/8-1825
9285	GM: 444667,1/2-1425
	GM: 444789		

Auveco Part No.	O.E.M. No.	Pipe Size	Unit Pkg.
-----------------	------------	-----------	-----------

9278	GM: 4446131/8-2725
9279	GM: 444619,1/4-1825
	GM: 444620		

BRASS FITTINGS

Inverted Flare Fittings



**Inverted Nut
(Brass)**

Auveco Part No.	Tube Size	Unit Pkg
30	3/16"	10
31	1/4"	10
32	5/16"	10
33	3/8"	10



**Male Connector
(Brass)**

Auveco Part No.	Tube Size	Pipe Thread	Unit Pkg
49	1/8"	1/8"	5
50	3/16"	1/8"	5
51	1/4"	1/8"	5
52	5/16"	1/8"	5
53	3/8"	1/4"	5



**90° Male Elbow
(Brass)**

Auveco Part No.	Tube Size	Pipe Thread	Unit Pkg
75	3/16"	1/8"	5
76	1/4"	1/8"	5
77	5/16"	1/8"	5
78	3/8"	1/4"	5



**Inverted Nut
(Steel)**

Auveco Part No.	Tube Size	Unit Pkg
35	1/8"	10
36	3/16"	10
37	1/4"	10
38	5/16"	10
39	3/8"	10



**Union
(Brass)**

Auveco Part No.	Tube Size	Unit Pkg
69	3/16"	5
70	1/4"	5
72	3/8"	5
73	1/2"	5



**45° Male Elbow
(Brass)**

Auveco Part No.	Tube Size	Pipe Thread	Unit Pkg
90	3/16"	1/8"	5
91	1/4"	1/8"	5



Steel Plug

Auveco Part No.	Tube Size	Unit Pkg
45	3/16"	10
46	1/4"	10
47	5/16"	10



**Male Branch
(Brass)**

Auveco Part No.	Tube Size	Pipe Thread	Unit Pkg
96	3/16"	1/8"	5



Sleeve (Brass)

Auveco Part No.	Tube Size	Unit Pkg
101	1/8"	25
102	3/16"	25
103	1/4"	25
104	5/16"	25
105	3/8"	25
107	1/2"	10

Compression Fittings



**Nut
(Brass)**

Auveco Part No.	Tube Size	Unit Pkg
110	1/8"	10
111	3/16"	10
112	1/4"	10
113	5/16"	10
114	3/8"	10
116	1/2"	10



**Male Elbow
(Brass)**

Auveco Part No.	Tube Size	Pipe Thread	Unit Pkg
158	1/8"	1/8"	5
159	3/16"	1/8"	5
161	1/4"	1/4"	5
162	5/16"	1/8"	5
163	5/16"	1/4"	5
164	3/8"	1/8"	5
165	3/8"	1/4"	5
167	1/2"	3/8"	5
168	1/2"	1/2"	5



Union: (Brass)

Auveco Part No.	Tube Size	Unit Pkg
150	1/8"	5
151	3/16"	5
152	1/4"	5
153	5/16"	5
154	3/8"	5
155	1/2"	5

(Continued on next page)

Sec. 13

BRASS FITTINGS Compression Fittings (continued)



Male Connector
(Brass)

Auveco Part No.	Tube Size	Pipe Thread	Unit Pkg.
119	1/8"	1/8"	5
120	3/16"	1/8"	5
121	1/4"	1/8"	5
122	1/4"	1/4"	5
123	5/16"	1/8"	5
124	5/16"	1/4"	5
125	3/8"	1/8"	5
126	3/8"	1/4"	5
127	3/8"	3/8"	5
128	1/2"	3/8"	5



Male Branch Tee
(Brass)

Auveco Part No.	Tube Size	Pipe Thread	Unit Pkg.
181	3/16"	1/8"	5
182	1/4"	1/8"	5
185	1/2"	3/8"	5



Female Connector
(Brass)

Auveco Part No.	Tube Size	Pipe Thread	Unit Pkg.
134	1/8"	1/8"	5
135	3/16"	1/8"	5
136	1/4"	1/8"	5
137	5/16"	1/8"	5



Male Run Tee
(Brass)

Auveco Part No.	Tube Size	Pipe Thread	Unit Pkg.
172	1/4"	1/8"	5



Adapter Tee
(Brass)

Auveco Part No.	Tube Size	Ext. Pipe Thd.	Int. Pipe Thd.
177	3/16"	1/8"	1/8"
178	1/4"	1/8"	1/8"

UNIT PACKAGE: 5



Union Tee
(Brass)

Auveco Part No.	Tube Size	Unit Pkg.
186	3/16"	5
187	1/4"	5
188	5/16"	5
189	3/8"	5

Double Compression (Threaded Sleeve) Fittings



Nut
(Brass)

Auveco Part No.	Tube Size	Unit Pkg.
192	1/8"	10
193	3/16"	10
194	1/4"	10



Male Connector
(Brass)

Auveco Part No.	Tube Size	Pipe Thread	Unit Pkg.
198	1/8"	1/8"	5
200	1/4"	1/8"	5
201	5/16"	1/8"	5



Male Elbow
(Brass)

Auveco Part No.	Tube Size	Pipe Thread	Unit Pkg.
205	1/8"	1/8"	5
206	3/16"	1/8"	5

S.A.E. 45° Flared Tube Fittings



SAE Flare Nut (Long)
(Brass)

Auveco Part No.	Tube Size	Unit Pkg.
211	3/16"	5
212	1/4"	5



SAE Flare Nut (Short)
(Brass)

Auveco Part No.	Tube Size	Unit Pkg.
221	1/4"	5
223	3/8"	5
224	1/2"	5



Male Elbow
(Brass)

Auveco Part No.	Tube Size	Pipe Thread	Unit Pkg.
228	1/8"	1/8"	5
229	3/16"	1/8"	5
230	1/4"	1/8"	5
231	1/4"	1/4"	5
232	5/16"	1/8"	5
233	5/16"	1/4"	5
234	3/8"	1/4"	5
235	3/8"	1/8"	5
236	3/8"	3/8"	5

BRASS FITTINGS

S.A.E. 45° FLARED TUBE FITTINGS (Continued)



Union
(Brass)

Auveco Part No.	Tube Size	Unit Pkg.
245	5/16"	5
246	3/8"	5
247	1/2"	5



Male Connector
(Brass)

Auveco Part No.	Tube Size	Pipe Thread	Unit Pkg.
261	1/4"	1/8"	5
262	1/4"	1/4"	5
263	5/16"	1/8"	5
264	5/16"	1/4"	5
265	3/8"	1/4"	5
266	3/8"	1/8"	5
268	1/2"	3/8"	5
269	1/2"	1/2"	5

**You Can
Help Auveco
Help You.**

**E-mail Your
New Item
Suggestions
To:
mail@auveco.com**



Cap
(Brass)

Auveco Part No.	Pipe Thread	Unit Pkg.
287	1/8"	5
288	1/4"	5

Pipe Fittings



Hex Head Plug
(Brass)

Auveco Part No.	Pipe Thread	Unit Pkg.
295	1/8"	5
296	1/4"	5
297	3/8"	5
298	1/2"	5



Close Nipple
(Brass)

Auveco Part No.	Lgth.	Pipe Thread	Unit Pkg.
305	3/4"	1/8"	5
306	7/8"	1/4"	5
307	1"	3/8"	5
308	1-1/8"	1/2"	5



Slotted Plug
(Brass)

Auveco Part No.	Pipe Thread	Unit Pkg.
289	1/8"	5
290	1/4"	5



Bushing
(Brass)

Auveco Part No.	Ext. Pipe Thd.	Int. Pipe Thd.	Unit Pkg.
299	1/4"	1/8"	5
300	3/8"	1/8"	5
301	3/8"	1/4"	5
302	1/2"	1/8"	5
303	1/2"	1/4"	5
304	1/2"	3/8"	5



Long Nipple
(Brass)

Auveco Part No.	Lgth.	Pipe Thread	Unit Pkg.
309	1-1/2"	1/8"	5
310	2"	1/8"	5
311	2-1/2"	1/8"	5
313	1-1/2"	1/4"	5
314	2"	1/4"	5
315	2-1/2"	1/4"	5



Square Head Plug
(Brass)

Auveco Part No.	Pipe Thread	Unit Pkg.
291	1/8"	5
292	1/4"	5
293	3/8"	5
294	1/2"	5

(Continued on next page)

Refer to page 236 for "Pipe Thread Identification"

Sec. 13

BRASS FITTINGS

Pipe Fittings (continued)



Hex Nipple
(Brass)

Auveco Part No.	Pipe Thd. A	Pipe Thd. B	Unit Pkg.
316	1/8"	1/8"	5
317	1/4"	1/4"	5
318	1/4"	1/8"	5
319	3/8"	3/8"	5
320	3/8"	1/8"	5
321	3/8"	1/4"	5
322	1/2"	1/2"	5



Adaptor
(Brass)

Auveco Part No.	Pipe Thd. A	Pipe Thd. B	Unit Pkg.
325	1/8"	1/8"	5
326	1/4"	1/8"	5
327	1/4"	1/4"	5
328	3/8"	1/4"	5
329	3/8"	3/8"	5
330	1/2"	3/8"	5



Coupling
(Brass)

Auveco Part No.	Pipe Thread	Unit Pkg.
331	1/8"	5
332	1/4"	5
333	3/8"	5
334	1/2"	5



Reducing Coupling
(Brass)

Auveco Part No.	Pipe Thd. A	Pipe Thd. B	Unit Pkg.
335	1/4"	1/8"	5
336	3/8"	1/8"	5
337	3/8"	1/4"	5
339	1/2"	3/8"	5



Union
(Brass)

Auveco Part No.	Pipe Thread	Unit Pkg.
340	1/8"	5
341	1/4"	5



90° Street Elbow
(Brass)

Auveco Part No.	Int. Pipe Thd.	Ext. Pipe Thd.	Unit Pkg.
342	1/8"	1/8"	5
343	1/4"	1/4"	5
344	3/8"	3/8"	5
345	1/4"	1/8"	5



45° Street Elbow
(Brass)

Auveco Part No.	Pipe Thread	Unit Pkg.
347	1/8"	5
348	1/4"	5
349	3/8"	5



90° Pipe Elbow
(Brass)

Auveco Part No.	Int. Pipe Thd.	Ext. Pipe Thd.	Unit Pkg.
350	1/8"	1/8"	5
351	1/4"	1/4"	5
352	3/8"	3/8"	5



Cross
(Brass)

Auveco Part No.	Pipe Thread	Unit Pkg.
353	1/8"	5
354	1/4"	5



Tee
(Brass)

Auveco Part No.	Pipe Thread	Unit Pkg.
355	1/8"	5
356	1/4"	5
357	3/8"	5



Male Branch Tee
(Brass)

Auveco Part No.	Pipe Thread	Unit Pkg.
358	1/8"	5



Street Tee
(Brass)

Auveco Part No.	Pipe Thread	Unit Pkg.
359	1/8"	5
360	1/4"	5

Pipe Thread Identification



1/8"



1/4"



3/8"



1/2"

BRASS FITTINGS

Drain Cocks and Valves



External Seat
(Brass)

Auveco Part No.	Pipe Thread	Unit Pkg.
370	1/8"	5
371	1/4"	5
372	3/8"	5



Compression Line
(Brass)

Auveco Part No.	Tube Size	Unit Pkg.
385	1/4"	3



Angle Bib Drain
(Brass)

Auveco Part No.	Pipe Thd.	A	Unit Pkg.
374	1/4"	1-11/16"	5



Ground Plug Drain
(Brass)

Auveco Part No.	Pipe Thread	Unit Pkg.
405	1/8"	5
406	1/4"	5



Female Pipe
Ground Plug Line
(Brass)

Auveco Part No.	Pipe Thread	Unit Pkg.
399	1/8"	3
401	1/4"	3



Compression Line
Ground Plug
(Brass)

Auveco Part No.	Tube Size	Unit Pkg.
389	5/16"	3



SAE Angle
(Brass)

Auveco Part No.	Tube Size	Pipe Thd.
395	1/4"	1/8"
398	3/8"	1/4"

UNIT PACKAGE: 3



Multiple Shut-Off Valves
Stem Short
(Brass)

Auveco Part No.	Desc.
404	3 Way 1/4 Female 3 Ends

UNIT PACKAGE: 1

View the Auveco Catalog on-line at www.auveco.com. You can search by Auveco part number, description, OEM number and competitive part number.

Sec. 13

BRASS FITTINGS



Ball End
Joint Adapter To
Taper Male Pipe

Auveco Part No.	Male N.P.S. Thread	Male N.P.T. Thread	Unit Pkg.
445	1/4"	1/4"	10
448	1/2"	3/8"	5



Barbed Hose Coupler

Auveco Part No.	I.D. Hose Size	Overall Length	Unit Pkg.
*419	3/16"	1.44"	5
420	1/4"	2.00"	5
421	5/16"	2.00"	5
422	3/8"	2.00"	5
423	1/2"	2.00"	5

* 3 Barb Design



Beaded Hose Barb
90° Elbow Tube To Male Pipe

Auveco Part No.	I.D. Hose Size	Pipe Thread	Unit Pkg.
461	1/2"	3/8"	3
462	5/8"	1/4"	3
463	5/8"	3/8"	3
464	5/8"	1/2"	3
465	3/4"	1/2"	2



Hose Barb To
Taper Female Pipe

Auveco Part No.	I.D. Hose Size	Pipe Thread	Unit Pkg.
437	1/4"	1/4"	5
438	5/16"	1/4"	5
439	3/8"	1/8"	5
440	3/8"	1/4"	5
441	3/8"	3/8"	5
442	1/2"	3/8"	5
443	1/2"	1/2"	5

Beaded Hose Barb
Tube To Male Pipe



Auveco Part No.	I.D. Hose Size	Pipe Thread	Unit Pkg.
413	3/8"	3/8"	5
415	1/2"	3/8"	5
416	5/8"	3/8"	5
417	5/8"	1/2"	5
418	3/4"	1/2"	5



Hose Barb To
Taper Male Pipe

Auveco Part No.	I.D. Hose Size	Pipe Thread	Unit Pkg.
424	3/16"	1/8"	10
425	1/4"	1/8"	10
426	1/4"	1/4"	10
427	1/4"	3/8"	5
428	5/16"	1/8"	10
429	5/16"	1/4"	5
430	3/8"	1/8"	10
431	3/8"	1/4"	10
432	3/8"	3/8"	5
433	1/2"	1/4"	5
434	1/2"	3/8"	5
435	1/2"	1/2"	5



Hose Barb 90° Elbow
Tube To Male Pipe

Auveco Part No.	I.D. Hose Size	Pipe Thread	Unit Pkg.
455	1/4"	1/8"	5
456	1/4"	1/4"	5
457	3/8"	1/4"	5



Brazier Head Solid Aluminum Rivets

Auveco Part No.	Dia.	Length	Head Dia.	Unit Pkg.
9643	3/16"	3/8"	15/32"	100
9644	3/16"	3/8"	15/32"	1000
12528	3/16"	1/2"	15/32"	100
12529	3/16"	1/2"	15/32"	1000
9647	1/4"	3/8"	5/8"	100
9648	1/4"	3/8"	5/8"	1000

RIVETS

Countersunk Head Drive Rivets Aluminum Rivet - Stainless Steel Pin



Auveco Part No.	Diameter	Grip	Unit Pkg.
9463	3/16"	3/16"	50

Refer To Pages 262 For Drill Bits Used With Rivets



Pan'1 Blind Rivets

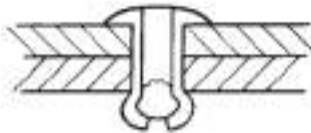

Dome Head

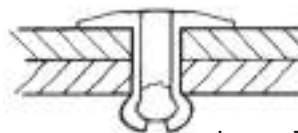

Large Flange

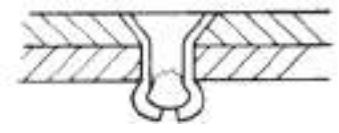

Countersunk

Auveco Part No. Unit Package Quantity					Head (Flange) Type & Diameter	Rivet Dia.	Grip Range	Rivet Length Exc. Flange	Cross Reference		
25	50	100	500	1000					POP®	Marson Klik-Fast	
Steel Rivet - Steel Mandrel - Plated											
—	—	19044	—	—	Dome 3/16"	3/32"	1/32" - 1/8"	15/64"	SD32BS	SB3-2	
—	—	19045	—	—	Dome 3/16"	3/32"	1/8" - 1/4"	23/64"	SD34BS	SB3-4	
—	—	19046	—	—	Dome 1/4"	1/8"	1/32" - 1/16"	13/64"	SD41BS	SB4-1	
—	—	5749	5748	8871	Dome 1/4"	1/8"	1/16" - 1/8"	7/32"	SD42BS	SB4-2	
—	—	5751	5750	8872	Cntrsнк 7/32"	1/8"	1/16" - 1/8"	7/32"	SK42BS	SC4-2	
—	—	8291	8290	8873	Lg Flange 3/8"	1/8"	1/16" - 1/8"	7/32"	SD42BSLF	SBL4-2	
—	—	8874	8875	—	Dome 1/4"	1/8"	1/8" - 3/16"	5/16"	SD43BS	SB4-3	
—	—	5753	5752	8877	Dome 1/4"	1/8"	3/16" - 1/4"	25/64"	SD44BS	SB4-4	
—	—	8303	8302	—	Cntrsнк 7/32"	1/8"	3/16" - 1/4"	25/64"	SK44BS	SC4-4	
—	—	8293	8292	8879	Lg Flange 3/8"	1/8"	3/16" - 1/4"	25/64"	SD44BSLF	SBL4-4	
—	—	8880	8881	8882	Dome 1/4"	1/8"	5/16" - 3/8"	1/2"	SD46BS	SB4-6	
—	—	19047	—	—	Dome 1/4"	1/8"	3/8" - 1/2"	41/64"	SD48BS	SB4-8	
—	—	8883	8884	—	Dome 5/16"	5/32"	1/16" - 1/8"	7/32"	SD52BS	SB5-2	
—	—	8886	8887	8888	Dome 5/16"	5/32"	3/16" - 1/4"	3/8"	SD54BS	SB5-4	
—	—	8889	—	—	Dome 3/8"	3/16"	1/16" - 1/8"	9/32"	SD62BS	SB6-2	
—	—	8892	8893	8894	Dome 3/8"	3/16"	1/8" - 1/4"	7/16"	SD64BS	SB6-4	
—	18811	—	—	—	Lg Flange 5/8"	3/16"	1/8" - 1/4"	7/16"	SD64BSLF	SBL6-4	
—	—	8895	8896	8897	Dome 3/8"	3/16"	1/4" - 3/8"	9/16"	SD66BS	SB6-6	
—	—	8305	8304	8898	Lg Flange 5/8"	3/16"	1/4" - 3/8"	9/16"	SD66BSLF	SBL6-6	
—	—	8899	8900	8901	Dome 3/8"	3/16"	3/8" - 1/2"	11/16"	SD68BS	SB6-8	
—	18812	—	—	—	Lg Flange 5/8"	3/16"	3/8" - 1/2"	11/16"	SD68BSLF	SBL6-8	
—	—	8902	8903	—	Dome 3/8"	3/16"	1/2" - 5/8"	13/16"	SD610BS	SB6-10	
18814	—	—	—	—	Lg Flange 5/8"	3/16"	5/8" - 3/4"	15/16"	SD612BSLF	SBL6-12	
21402	—	—	—	—	Dome 1/2"	1/4"	5/8" - 3/4"	1"	SD812BS	—	
19048	—	—	—	—	Dome 1/2"	1/4"	3/4" - 1"	1-15/64"	SD816BS	—	

(Continued on next page)

Sec. 14

PAN'L BLIND RIVETS (Cont.)



Auveco Part No. Unit Package Quantity					Head (Flange) Type & Diameter	Rivet Dia.	Grip Range	Rivet Length Exc. Flange	Cross Reference	
25	50	100	500	1000					POP®	Marson Klik-Fast
Aluminum Rivet - Steel Mandrel										
—	—	8905	8906	8907	Dome 1/4"	1/8"	1/16" - 1/8"	7/32"	AD42BS	AB4-2
—	—	8908	8909	—	Cntrs nk 7/32"	1/8"	1/16" - 1/8"	7/32"	AK42BS	AC4-2
—	—	8911	8912	8913	Dome 1/4"	1/8"	3/16" - 1/4"	3/8"	AD44BS	AB4-4
—	—	8914	8915	—	Cntrs nk 7/32"	1/8"	3/16" - 1/4"	3/8"	AK44BS	AC4-4
—	—	19049	—	—	Dome 1/4"	1/8"	3/8" - 1/2"	41/64"	AD48BS	AB4-8
—	—	19050	—	—	Dome 5/16"	5/32"	3/16" - 1/4"	27/64"	AD54BS	AB5-4
—	—	8295	8294	8917	Dome 3/8"	3/16"	1/16" - 1/8"	9/32"	AD62BS	AB6-2
—	—	8307	8306	8918	Dome 3/8"	3/16"	1/8" - 1/4"	3/8"	AD64BS	AB6-4
—	—	8297	8296	8919	Dome 3/8"	3/16"	1/4" - 3/8"	9/16"	AD66BS	AB6-6
—	19051	—	—	—	Lg Flange 5/8"	3/16"	3/8" - 1/2"	11/16"	AD68BSLF	ABL6-8
Aluminum Rivet - Aluminum Mandrel										
—	—	19053	—	—	Dome 3/16"	3/32"	1/32" - 1/8"	15/64"	AD32ABS	AB3-2A
—	—	8309	8308	8920	Dome 1/4"	1/8"	1/16" - 1/8"	7/32"	AD42ABS	AB4-2A
—	—	8299	8298	—	Cntrs nk 7/32"	1/8"	1/16" - 1/8"	7/32"	AK42ABS	AC4-2A
—	—	8922	8923	8924	Lg Flange 3/8"	1/8"	1/16" - 1/8"	7/32"	AD42ABSLF	ABL4-2A
—	—	8925	8926	8927	Dome 1/4"	1/8"	3/16" - 1/4"	3/8"	AD44ABS	AB4-4A
—	—	8928	8929	8930	Cntrs nk 7/32"	1/8"	3/16" - 1/4"	3/8"	AK44ABS	AC4-4A
—	—	8931	8932	8933	Lg Flange 3/8"	1/8"	3/16" - 1/4"	3/8"	AD44ABSLF	ABL4-4A
—	—	16031	—	—	Dome 1/4"	1/8"	5/16" - 3/8"	1/2"	AD46ABS	AB4-6A
—	—	16032	—	—	Dome 1/4"	1/8"	3/8" - 1/2"	5/8"	AD48ABS	AB4-8A
—	—	20474	—	—	Lg. Flange 3/8"	1/8"	3/8" - 1/2"	5/8"	—	ABL4-8A
—	—	18727	—	—	Dome 5/16"	5/32"	1/16" - 1/8"	9/32"	AD52ABS	AB5-2A
—	—	18728	—	—	Dome 5/16"	5/32"	1/8" - 3/16"	11/32"	AD53ABS	AB5-3A
—	—	18729	—	—	Dome 5/16"	5/32"	3/16" - 1/4"	13/32"	AD54ABS	AB5-4A
—	18732	—	—	—	Lg Flange 15/32"	5/32"	3/16" - 1/4"	13/32"	AD54ABSLF	—
—	—	18730	—	—	Dome 5/16"	5/32"	1/4" - 3/8"	1/2"	AD56ABS	AB5-6A
—	18731	—	—	—	Dome 5/16"	5/32"	3/8" - 1/2"	5/8"	AD58ABS	AB5-8A
—	—	5755	5754	8934	Dome 3/8"	3/16"	1/16" - 1/8"	9/32"	AD62ABS	AB6-2A
—	—	8311	8310	8935	Dome 3/8"	3/16"	1/8" - 1/4"	7/16"	AD64ABS	AB6-4A
—	19055	—	—	—	Lg Flange 5/8"	3/16"	1/8" - 1/4"	7/16"	AD64ABSLF	ABL6-4A
—	—	8301	8300	8936	Dome 3/8"	3/16"	1/4" - 3/8"	9/16"	AD66ABS	AB6-6A
—	—	8313	8312	8937	Lg Flange 5/8"	3/16"	1/4" - 3/8"	9/16"	AD66ABSLF	ABL6-6A
—	—	8938	8939	8940	Dome 3/8"	3/16"	3/8" - 1/2"	11/16"	AD68ABS	AB6-8A
—	19056	—	—	—	Lg Flange 5/8"	3/16"	3/8" - 1/2"	11/16"	AD68ABSLF	ABL6-8A
—	—	18489	—	—	Dome 3/8"	3/16"	1/2" - 5/8"	13/16"	AD610ABS	AB6-10A
19057	—	—	—	—	Lg Flange 5/8"	3/16"	1/2" - 5/8"	13/16"	AD610ABSLF	ABL6-10A
19058	—	—	—	—	Dome 1/2"	1/4"	1/4" - 3/8"	39/64"	AD86ABS	AB8-6A
Stainless Steel Rivet - Stainless Steel Mandrel										
—	19060	—	—	—	Dome 1/4"	1/8"	3/16" - 1/4"	25/64"	SSD44SSBS	SSB4-4S
19061	—	—	—	—	Dome 3/8"	3/16"	3/8" - 1/2"	11/16"	SSD68SSBS	SSB6-8S
Stainless Steel Rivet - Steel Mandrel										
Replaces Ford No.: 383229-S To replace welded studs on body. (Use Auveco Rivet Gun No. 7915 w/ No. 7981 Nose Piece.)										
—	—	11104	11105	11106	Sm. Flange 3/16"	1/8"	3/16" - 1/4"	5/16"	R4357	SSBN4-3

RIVET GUNS & ACCESSORIES



Steel Rivet Washers

Zinc

16791

For 1/8" Dia.
1/2" O.D.

U.P.: 100

15973

For 5/32" Dia.
1/2" O.D.

U.P.: 100

16792

For 3/16" Dia.
15/32" O.D.

U.P.: 100

RIVET GUNS & ACCESSORIES

19234

Economy Rivet Gun
With 3/32", 1/8", 5/32" and 3/16" nose pieces.
Overall Length: 10"
Replacement accessories are not available

UNIT PACKAGE: 1



7915

Pan'l Rivet Gun
With 3/32", 1/8", 5/32" and 3/16" nose pieces
Overall Length: 9-1/2"

UNIT PACKAGE: 1



19215

Replacement Jaws
For Auveco Rivet Gun
7915

UNIT PKG. 1 Set



**Nose Pieces
For 7915 Rivet Gun**

Auveco Part No.	Description	Unit Pkg.
7981	Use with 1/8" rivet 11104 to replace welded studs	1
7982	For 3/32" diameter rivets	1
7983	For 1/8" diameter rivets	1
7984	For 5/32" diameter rivets	1
7985	For 3/16" diameter rivets	1
7986	A set of one each of 7982, 7983, 7984 and 7985	1 Set

For the most up-to-date information on new items available from Auveco, refer to the "Hot New Items" section of the Auveco website (www.auveco.com)



11817

Rivet gun for setting 3/16" & 1/4" rivets.
Use to install "Peel-Type" Rivets
Comes complete with 3/16" and 1/4" standard
nose pieces plus a nose piece
for 1/4" "Peel Type" rivets. 22" long.

UNIT PACKAGE: 1

11817 Rivet Gun Accessories



19132

Nose piece
for 1/8"
standard rivets

UNIT PKG: 1



19133

Nose piece
for 3/16"
standard rivets

UNIT PKG: 1



19134

Nose piece
for 1/4"
standard rivets

UNIT PKG: 1



11853

Nose piece for
1/4" "peel type"
rivets.

UNIT PKG: 1



21656

Nose Piece
For 1/4"
Monobolts

UNIT PACKAGE: 1



14799

Replacement jaws
repair kit for rivet gun 11817

UNIT PKG: 1



13808

For 3/16"

13809

For 1/4"

Nose pieces for setting
Auveco Klamp-Tite Rivets with a
Pneumatic Tool.

UNIT PKG: 1



21655

Nose Piece
For 3/16"
Monobolts

UNIT PACKAGE: 1



19066

Rivet Gun
With nose pieces for
3/32", 1/8", 5/32", 3/16" & 1/4" diameter rivets.
Overall Length: 21"

UNIT PACKAGE: 1



Not Actual Size

17498

11817 Rivet Gun Extender Nosepiece Adapter Kt

To retrofit Auveco Rivet Gun 11817 with nosepiece
that extends the reach by 2-1/2" for a total of 5".

UNIT PACKAGE: 1

**14577**

Replacement jaws repair kit
for 12087 monobolt setting tool.

UNIT PACKAGE: 1

RIVET GUNS FOR NYLON RIVETS**14155****Rivet Setter Gun**

(For Nylon Rivets)

For use with nylon blind rivets. An economical tool that provides the extra long pulling stroke needed to set nylon (plastic) rivets. It features all steel construction and full-size vinyl coated handles for smooth, easy operation. Not for use with metal rivets. 9-1/2" long

UNIT PACKAGE: 1

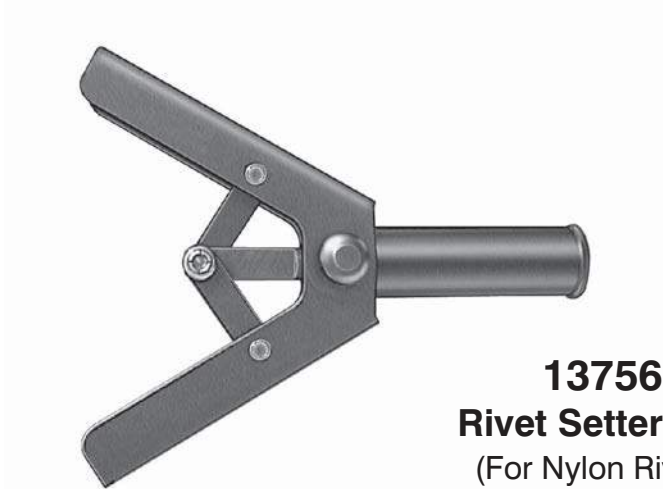
**13756****Rivet Setter Gun**

(For Nylon Rivets)

For use with nylon (plastic) blind rivets. A durable tool that sets all sizes with a single stroke. All steel construction. Not for use with metal rivets. 6-1/2" long.

UNIT PACKAGE: 1

POP® MULTI-GRIP BLIND RIVETS
 Functions In A Wide Range Of Material Thicknesses



The Multi-Grip rivet will serve in applications where solid and soft materials and thicknesses normally require several rivet sizes. Oversize, irregular or misaligned holes are automatically compensated for by the self-adjusting hole-filling capability. The mandrel head is retained in the rivet body, forming a tight, weather resistant seal.

Auveco Part No.	Head Style & Diameter		Rivet Dia.	Hole Size	Grip Range	Rivet Length Excluding Flange	Unit Pkg.	POP® No.
Aluminum Rivet, Steel Mandrel								
19033	Large Flange	3/8"	1/8"	.129"-.142"	3/64"-3/16"	21/64"	100	AD41-43BSLF
19025	Dome	1/4"	1/8"	.129"-.142"	5/32"-5/16"	15/32"	100	AD43-45BS
19034	Large Flange	3/8"	1/8"	.129"-.142"	5/32"-5/16"	15/32"	100	AD43-45BSLF
19026	Dome	1/4"	1/8"	.129"-.142"	1/4"-7/16"	39/64"	100	AD45-47BS
18743	Dome	5/16"	5/32"	.160"-.173"	3/64"-1/4"	13/32"	100	AD52-54BS
17468	Large Flange	15/32"	5/32"	.160"-.173"	3/64"-1/4"	13/32"	50	AD52-54BSLF
19027	Dome	5/16"	5/32"	.160"-.173"	1/8"-5/16"	1/2"	50	AD53-55BS
18744	Dome	3/8"	3/16"	.192"-.205"	1/16"-1/4"	7/16"	50	AD62-64BS
19036	Large Flange	5/8"	3/16"	.192"-.205"	1/16"-1/4"	7/16"	50	AD62-64BSLF
19028	Dome	3/8"	3/16"	.192"-.205"	3/16"-3/8"	5/8"	50	AD63-66BS
19029	Dome	3/8"	3/16"	.192"-.205"	1/4"-1/2"	47/64"	50	AD66-68BS
19037	Large Flange	5/8"	3/16"	.192"-.205"	1/4"-1/2"	47/64"	50	AD66-68BSLF
19030	Dome	3/8"	3/16"	.192"-.205"	7/16"-3/4"	1-1/16"	50	AD68-612BS
19031	Dome	1/2"	1/4"	.261"-.275"	5/64"-11/32"	39/64"	25	AD82-86BS

AUTOMOTIVE O.E.M. NYLON BLIND RIVETS

Sec. 14

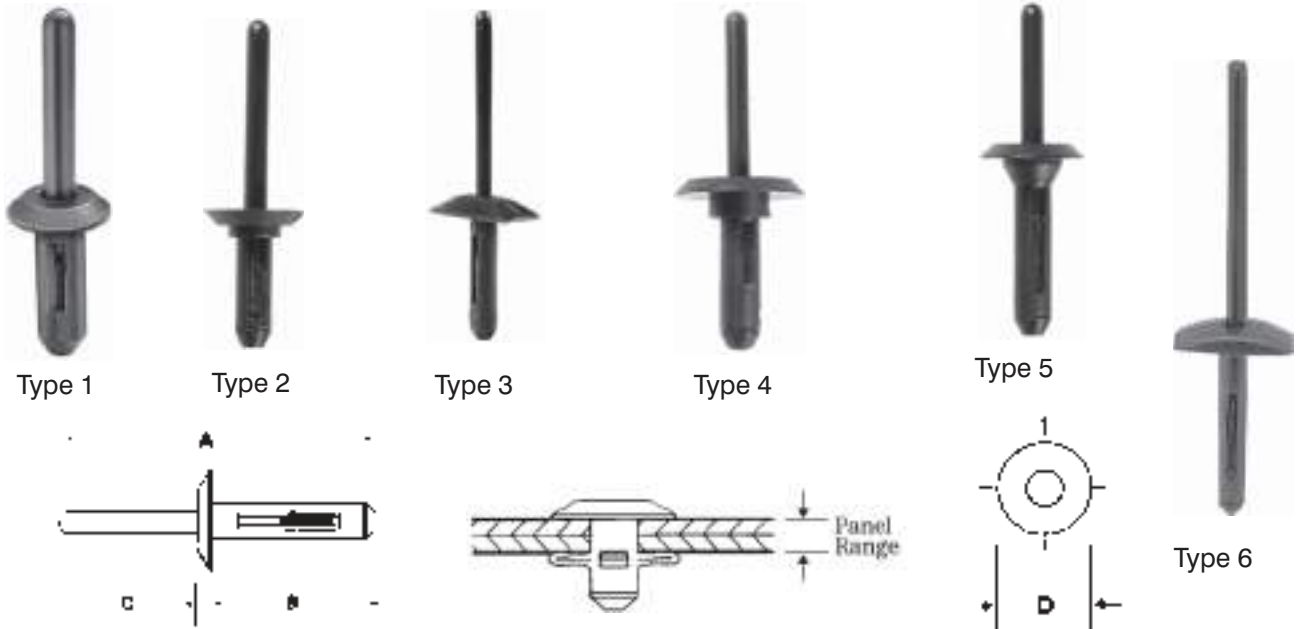

Auveco No.	Type	Color	O.E.M. Number	Hole Dia.	Panel Grip (Range)	A	B	C	D	Unit Pkg
17220	3	Black	GM: 21094747	5/32"	7/64"-7/32"	1-7/8"	3/4"	3/32"	**	50
15187	6	Black	Ford: N804583S	4mm	6mm-10.5mm	65mm	26mm	2.5mm	***	25
13746	1	Black	GM: 20612732	3/16"	1/16"-9/64"	1-7/8"	23/32"	3/32"	11/32"	25
18501	1	Black	Chry: 6502689	3/16"	5/32"-1/4"	1-27/32"	21/32"	1/16"	11/32"	25
21327	1	Black	GM: 11588308	4.95mm	3mm - 6mm	48mm	18mm	1.7mm	9mm	25
13747	1	Black	GM: 20423647 Ford: N804189S	13/64"	1/16"-11/64"	1-7/8"	23/32"	1/8"	15/32"	25
14005	1	Black	GM: 20465395, Chry: 6004212	13/64"	1/8"-5/32"	1-13/16"	21/32"	1/16"	11/32"	25
13748	1	Black	GM: 20432975 VW: 175-853-57701C Chry: 6503800 Ford: N804343S	13/64"	1/8"-15/64"	1-7/8"	25/32"	1/16"	15/32"	25
13754	1	Black	Chry: 6500859	13/64"	1/8"-3/16"	1-7/8"	25/32"	1/16"	15/32"	25
13755	1	Black	Chry: 6500898 GM: 15718794	13/64"	15/64"-25/64"	2"	1"	1/16"	15/32"	25
14004	1	Black	GM: 25524005	15/64"	11/64"-11/32"	2-3/64"	1-1/8"	3/32"	1/2"	25
14023	1	Black	GM: 10036503	15/64"	5/32"-5/16"	2-1/8"	1-5/32"	3/32"	5/8"	25
18913	1	Black	Chry: 6503938	15/64"	5/32"-9/32"	2-5/32"	1-1/16"	3/32"	1/2"	25
20754	1	Black	BMW: 51-71-7-002-953-2	6mm	2.5mm-4.8mm	53mm	22mm	2.5mm	20mm	25
18028	2	Black	Chry: 4630088	1/4"	1/32"-11/64"	2-3/16"	13/16"	3/32"	21/32"	25
18031	2	Black*	Chry: 4630660	1/4"	1/32"-3/16"	2-1/8"	3/4"	3/32"	21/32"	25
15488	4	Black	GM: 10069112	1/4"	3/64"-5/32"	2-3/16"	15/16"	7/64"	13/16"	50
18242	5	Black	Chry: 6501509	1/4"	3/64"-3/16"	2-7/32"	1-1/8"	3/32"	25/32"	25
13749	1	White	GM: 14070914	1/4"	5/32"-15/64"	2-3/16"	23/32"	3/32"	21/32"	25
21446	1	Black	Chry: 6508444-AA	1/4"	5/32"-15/64"	2-3/16"	1-1/8"	3/32"	1-1/32"	15
18502	1	Black	General Purpose	1/4"	5/32"-1/4"	2-3/16"	23/32"	3/32"	21/32"	25
21028	1	Black	GM: 15614746	1/4"	5/32"-3/8"	2-3/16"	1-1/8"	3/32"	21/32"	25
18108	1	Black	Chry: 34201631	1/4"	5/32"-3/8"	2-7/32"	1-1/8"	3/32"	11/16"	25

* Black Rivet Body, White Mandrel
 ** 5/16" x 19/32"

*** 8.5mm x 15.5mm

(Continued on next page)

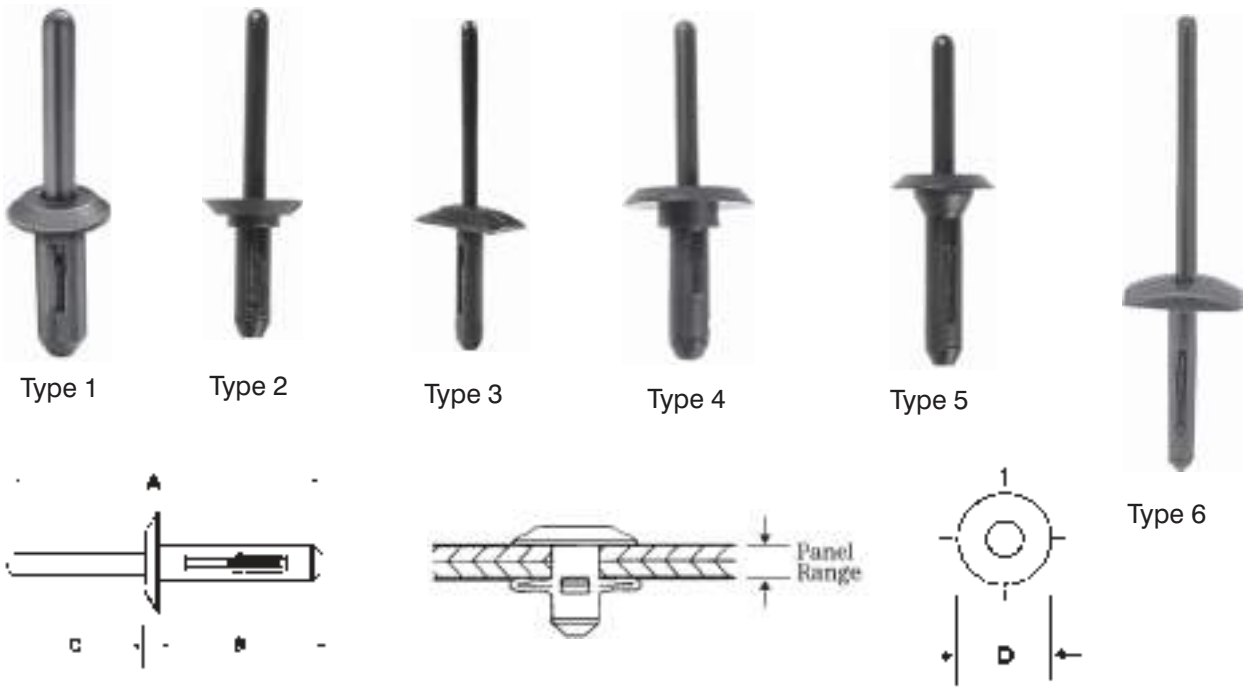

Auveco No.	Type	Color	O.E.M. Number	Hole Dia.	Panel Range (Grip)	A	B	C	D	Unit Pkg
17496	1	Gray	AMC: 8934-201-835	1/4"	5/32"-3/8"	2-7/32"	1-1/8"	3/32"	11/16"	25
14012	1	White	GM: 15506827	1/4"	5/32"-13/32"	2"	1-1/8"	3/32"	21/32"	25
13751	1	Black	GM: 10184895 Ford: N803862-S Chry: 6501559, 6506007-AA	1/4"	5/32"-13/32"	2-3/16"	1-3/32"	3/32"	1/2"	25
13750	1	Black	GM: 14063981 Ford: N803043-S Chry: 6500911, 6504700	1/4"	5/32"-13/32"	2-3/16"	1-3/32"	3/32"	21/32"	25
15491	1	Black	Ford: N804759-S	1/4"	19/64"-27/64"	2-1/8"	13/16"	3/32"	21/32"	25
17101	1	Black	Chry: 4370138, 6503860 Ford: N804675S	1/4"	5/16"-15/32"	2-9/32"	1-1/4"	3/32"	21/32"	25
13752	1	Black	GM: 15955172, 20421672	17/64"	3/32"-3/16"	1-7/8"	25/32"	3/32"	1/2"	25
13753	1	Black	GM: 20433026 VW: 175-853-577A	17/64"	3/32"-3/16"	1-7/8"	25/32"	3/32"	23/32"	25
15490	1	Black	GM: 10109689, 12337915	9/32"	3/32"-15/64"	2-3/16"	15/16"	3/32"	23/32"	25

Note: Use rivet guns 13756 or 14155 to install all of the above rivets.

***When The World Thinks Of
Body Hardware & Specialty Fasteners,
Only One Name Comes To Mind..... Auveco***

What Makes Avex® Different...And Better?

The Avex® rivet adds important... and exclusive...features to those offered by ordinary blind rivets. The unique advantages designed into the Avex® rivet allow for its use:

In wide-tolerance holes. Since the rivet can expand up to its own head diameter, accurate hole sizing or alignment is not necessary.

To pull sheets together. The extraordinary rivet tail expansion automatically effects superior clamp-up action on the parts being assembled.

Over a vast range of thicknesses. The "dubble-bubble" expansion feature offers the capability to fasten securely in both thick and thin grip ranges with a single length rivet.

While providing a sealed stem. The rivet material flows both behind and in front of the mandrel insuring a positively retained and sealed stem.

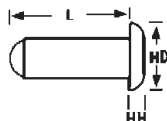

Dome Head

Aluminum Rivets
Steel Mandrels
(Zinc & Yellow)

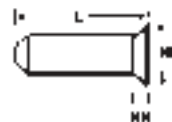

120° Countersunk

Auveco Part No.				Head (Flange) Style	Rivet Dia.	Grip	Length L	Flange Dia. HD	Flange Height HH	Hole Size
Unit Package										
50	100	500	1000							
•••••	10336	10337	•••••	Countersunk	1/8"	To 1/4"	15/32"	.205"	.030"	.136"
•••••	10348	10349	10350	Dome	1/8"	To 5/16"	1/2"	.215"	.044"	.136"
•••••	10351	10352	•••••	Dome	5/32"	To 1/4"	15/32"	.255"	.057"	.166"
•••••	10354	10355	10356	Dome	3/16"	To 1/4"	17/32"	.349"	.070"	.199"
•••••	10357	10358	10359	Dome	3/16"	To 7/16"	23/32"	.349"	.070"	.199"
•••••	10345	10346	•••••	Countersunk	3/16"	To 1/2"	25/32"	.339"	.050"	.199"
17654	17655	•••••	•••••	Dome	1/4"	To 11/32"	21/32"	.500"	.094"	.268"

Avex® Brazier Head Rivets



Auveco Part No.	Rivet Dia.	Grip Range	Rivet Body Length	Head Dia.	Unit Pkg.
Aluminum Rivet -Steel Mandrel (Zinc)					
17432	3/16"	1/16"-1/4"	1/2"	15/32"	50
17433	3/16"	3/16"-7/16"	11/16"	15/32"	50

Large Head 3/16" Plywood Rivets



Non-Structural -Break Mandrel Rivets
Aluminum Rivet, Steel Mandrel (Plated)

Auveco Part No.	Grip	Hd. Dia.	Head Thick.	Hole Size & Drill	Unit Pkg.
13805	3/8"-1/2"	5/8"	3/32"	.192 To .196"	50
13807	7/8"-1"	5/8"	3/32"	#11	50

Stavex® Large Flange Rivets



- Large flange head enables soft, pliable materials to be fastened
- All steel construction (zinc plated) provides high shear and tensile values.
- Typical applications:
 - Plastic energy absorber strip to automotive bumper
 - Plywood liners to both sidewalls and roofs in truck bodies and trailers

Auveco Part No.	Dia.	Grip	Flange Dia.	Hole Size	Unit Pkg.
16988	3/16"	3/16"-1/4"	5/8"	.192-.196"	25
16989	3/16"	1/4"-3/8"	5/8"	.192-.196"	25
16990	3/16"	3/8"-1/2"	5/8"	.192-.196"	25

Sec. 14

AUVECO KLAMP-TITE RIVET

Largest Blind Head
Mandrel Breaks Flush With Top Of Rivet Head Anywhere Within Grip Range.
Fills Hole Tightly, High Clamp-Up, Water Tight Capability, Fully Cored



Material: Rivet 5056 Aluminum, Mandrel -7075 Aluminum
Finish: Wax (Do Not Remove)

Structural - Self Plugging
Head Style - Protruding

Note: For use with pneumatic tool using (13808-3/16") and (13809-1/4") nose pieces on page 242.



Auveco Part No.	Unit Pkg.	Rivet Dia.	Grip Range	Hole And Drill Size	Mand. Dia.	Rivet Dia.	Head Dia.	Head Thick	Rivet Length Max.
13766	50	3/16	3/64"-1/4"	.204-.209 (#5)	.103	.200	.445	.088	.890
13767			3/16"-3/8"						.985
13768			3/8"-9/16"						1.045
13769	25	1/4	3/64"-1/4"	.252-.262 (F)	.136	.245	.560	.113	.920
13770			3/16"-3/8"						1.045

BLIND TACKING RIVETS

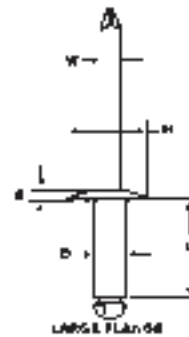

Nom. Rivet Dia.	Hole Size And Drill Number	W Mand. Dia.	D Rivet Dia.	Protruding Head		Large Flange Head	
				H Head Dia.	E Max.	H Head Dia.	E Max
1/4"	.257-.261 (F)	.151	.250	.500	.080	.750	.107

Steel Rivet -Plated
Steel Mandrel -Coated

Non-structural -Break mandrel rivets
Conform to IFI-114 Standards

Auveco Part No.			Head Style	Rivet Dia.	Grip	Rivet Length L
Unit Package						
25	50	100	Large Flange	1/4"	1/8"-1/4"	1/2"
13793						
13781	—	13782	Protruding	1/4"	1/4"-3/8"	5/8"
13796	—	—	Large Flange	1/4"	1/2"-5/8"	13/16"

Large Secondary Head Rivets



Rivets that fasten securely into thick and thin materials.
Will pull soft or brittle materials. Can be used in an oversized hole.

Auveco Part No.	Head (Flange) Type & Diameter	Rivet Dia.	Grip Range	Rivet Length Excluding Flange	Unit Pkg.
Aluminum Rivet, Aluminum Mandrel					
17471*	Dome	5/16"	1/8"	5/64"-3/8"	25
19062	Dome	5/16"	5/32"	0-1/4"	25

* Not A Split Type

MONOBOLT® FASTENING SYSTEM

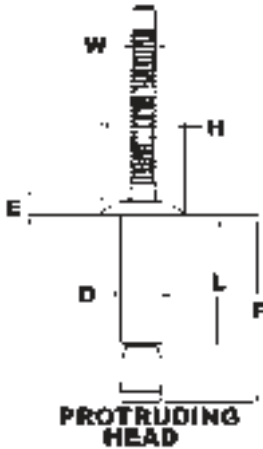

Nom. Rivet Dia.	Hole Size And Drill Number	W Mand. Dia.	D Rivet Dia.	Protruding Head	
				H Head Dia.	E Head Thick
3/16	.191-.201 (#11)	.118	.187	.390	.070
1/4	.261-.272(G)	.157	.257	.515	.100

Typical Rivet Shear And Tensile Strength (lbs) and Mandrel Push-Out When Installed In Nominal Grip.

Rivet Dia.	Aluminum Rivet Aluminum Mandrel			Steel Rivet Steel Mandrel		
	Shear	Tensile	Mandrel Push-Out	Shear	Tensile	Mandrel Push-Out
3/16	625	500	50	1300	1000	100
1/4	1300	890	100	2400	2150	250



Auveco Part No.	Dia	Grip	DIM "L"	DIM "F"	Head Style	Material	Unit Pkg.
12080	3/16"	.062/.270	.406	.748	Protruding	Steel-Zinc Plated	25
12088	3/16"	.062/.270	.406	.748	Protruding	Steel-Zinc Plated	100
12081	3/16"	.214/.420	.531	.882	Protruding	Steel-Zinc Plated	25
12089	3/16"	.214/.420	.531	.882	Protruding	Steel-Zinc Plated	100
12083	3/16"	.214/.420	.531	.846	Protruding	Aluminum	25
12091	3/16"	.214/.420	.531	.846	Protruding	Aluminum	100
12084	1/4"	.080/.375	.550	.971	Protruding	Steel-Zinc Plated	25
12092	1/4"	.080/.375	.550	.971	Protruding	Steel-Zinc Plated	100
12085	1/4"	.350/.625	.855	1.123	Protruding	Steel-Zinc Plated	25
12093	1/4"	.350/.625	.855	1.123	Protruding	Steel-Zinc Plated	100
12086	1/4"	.080/.375	.550	.961	Protruding	Aluminum	25
12094	1/4"	.080/.375	.550	.961	Protruding	Aluminum	100
13773	1/4"	.350/.625	.810	1.174	Protruding	Aluminum	25
13774	1/4"	.350/.625	.810	1.174	Protruding	Aluminum	100

The System

Blind Installation -The single side installation feature of the Auveco Monobolt System allows one operator to produce high quality structural joints in seconds. Use of the Monobolt power tool does not require special skill or training, because the tool completely controls the installation cycle.

Multi-Grip One size Monobolt fastener will function effectively in a wide range of material thicknesses (Example: .080" to .375"). This versatility decreases the potential for production errors and reduces fastener inventory requirements.

Uniform Clamping Action Monobolt fasteners are engineered to draw materials together by developing positive clamping action.



And Its Advantages

Structural Fastening An installed Monobolt fastener yields high shear and tensile values. Conventional fasteners can be replaced by Monobolt without compromising structural requirements.

Positive Stem Retention: At the completion of the installation cycle, the stem is mechanically locked into the Monobolt shell, creating a vibration-proof joint of assured structural quality.

Flush Break Stem: Within the specific grip range for each size, Monobolt fastener, the stem is designed to break flush with the low profile head. Secondary finishing operations, such as grinding or milling, are not necessary to achieve good product appearance.

Complete Hole Fill: During installation, the Monobolt shell expands into 360° contact with the walls of the parent material. This feature, in conjunction with positive stem retention, produces weather resistant joints.

Quiet, Safe Installation: The Monobolt System, operating at 85db ("A" Weighted), complies with OSHA regulation governing plant noise levels and operator safety

How It Works



1. The Monobolt fastener is loaded into the nose of the placing tool and inserted in a prepared hole. As the tool is actuated, the pulling jaws grip the Monobolt stem.



2. An axial pull draws the stem through the shell, expanding it radially. During this phase, the hole is completely filled and work pieces are drawn together.



3. When the stem reaches a pre-determined position within the Monobolt shell, it separates flush with the head profile regardless of work piece thickness. Simultaneously, the stem section remaining in the shell is mechanically locked in place by the Monobolt tool.

INTERLOCK® DOME HEAD HIGH STRENGTH RIVETS



High strength Interlock® rivets feature a positive mechanical locking system that provides superior holding power. This system also guarantees 100% mandrel retention that's visually verifiable. Can be set with Auveco rivet gun 11817.

Auveco Part No.	Rivet Dia.	Grip Range	Rivet Body Length	Head Dia.	Unit Pkg.	Conversion			
						Interlock®	Cherry Monobolt	Avdel Monobolt	Huck Magna-Lock
Aluminum Rivet -Aluminum Mandrel									
17421	3/16"	1/16" -17/64"	13/32"	3/8"	25	AD627OUG	BAPV-64	2774-0613	MGLP-B6-4
17422	3/16"	1/16" -7/16"	9/16"	3/8"	25	AD6437UGX	—	2774-0617	MGLP-B6-E
17423	1/4"	5/64" -3/8"	9/16"	1/2"	25	AD8375UG	BAPV-86	2774-0817	MGLP-B8-6
17424	1/4"	5/64" -5/8"	13/16"	1/2"	15	AD8625UGX	—	2774-0824	MGLP-B8-E
Steel Rivet -Steel Mandrel									
17425	3/16"	1/16" -17/64"	13/32"	3/8"	25	SD627OUG	SSPV-64	2771-0613	MGLP-R6-4
17427	1/4"	5/64" -3/8"	9/16"	1/2"	25	SD8375UG	SSPV-86	2771-0817	MGLP-R8-6
17428	1/4"	5/64" -5/8"	13/16"	1/2"	15	SD8625UGX	—	2771-0824	MGLP-R8-E
Stainless Steel Rivet -Stainless Steel Mandrel									
17429	3/16"	1/16" -17/64"	13/32"	3/8"	10	SSD627OUG	CCPV64	2711-0613	MGLP-U6-4



Closed -End Rivets

Can Be Set With Auveco Rivet Gun 7915.

Auveco Part No.	Head (Flange) Type & Diameter	Rivet Dia.	Grip Range	Rivet Length Excluding Flange	Unit Pkg.
Black Aluminum Rivet -Black Aluminum Mandrel					
17408	Dome	15/64"	1/8"	13/64" - 9/32"	50
17410	Dome	3/8"	3/16"	3/8" -1/2"	25
Aluminum Rivet -Aluminum Mandrel					
17419	Dome	3/8"	3/16"	1/16" - 1/8"	50
17420	Dome	3/8"	3/16"	1/8" - 1/4"	50
Aluminum Rivet -Steel Mandrel					
17411	Dome	15/64"	1/8"	1/16" - 1/8"	50
19065	Countersunk	5/16"	5/32"	1/8" - 3/16"	100
17414	Dome	3/8"	3/16"	1/16" - 1/8"	50
17415	Dome	3/8"	3/16"	1/8" - 1/4"	50
17416	Dome	3/8"	3/16"	1/4" - 3/8"	50

"PEEL-TYPE" SPECIALTY RIVETS

Sec. 14

Rivets Are Listed In Columns By Diameter Then By Flange Diameter & Lastly By Minimum Grip



19462

(W525170-S)

"Peel-Type" Rivet
3/16" Diameter
Grip: 1/32"-1/4"
Flange Diameter: 1/2"
Aluminum Rivet
Steel Mandrel (Zinc)
Heat Shield &
Outer Moulding
Ford Continental,
Crown Victoria,
Explorer, Grand Marquis,
Mark VII, Ranger, Sable
Taurus & Town Car
1995-On

UNIT PACKAGE: 25



19110

(W525172-S)

"Peel-Type" Rivet
1/4" Diameter
Grip: 1/32"-7/32"
Flange Diameter: 1/2"
Aluminum Rivet
Steel Mandrel (Zinc)
Glass, Regulator Assembly
& Remote Latch Assembly
Ford Mustang &
Lincoln Continental
1994-On

UNIT PACKAGE: 25



11852

(Ford: 388047-S100;
GM: 14078435)

"Peel-Type" Rivet
1/4" Diameter
Grip: 5/64" - 7/64"
Flange Diameter 1/2"
Recess Under Head
Aluminum Rivet
Steel Mandrel
Attaches Outside
Door Handle
Ford 1978-On
Heat Shield Attachment
GM

UNIT PACKAGE: 25



19414

(W525170-S417)

"Peel-Type" Rivet
3/16" Diameter
Grip: 1/32"-1/4"
Flange Diameter: 1/2"
Aluminum Rivet (Black)
Steel Mandrel (Zinc)
Side Door
Lock Attachment
Mercury Villager
1995-On

UNIT PACKAGE: 25



19461

(W525172-S417)

"Peel-Type" Rivet
1/4" Diameter
Grip: 1/32"-7/32"
Flange Diameter: 1/2"
Aluminum Rivet (Black)
Steel Mandrel (Zinc)
Outside Door Handle
Ford Crown Victoria,
Econoline, Explorer,
Grand Marquis, Ranger,
Sable, Taurus & Windstar
1995-On

UNIT PACKAGE: 15



12653

(388047-S102)

"Peel-Type" Rivet
Dia: 1/4"
Grip: 3/32"-1/8"
Flange Dia: 1/2"
Aluminum Rivet (Black)
Steel Mandrel
Door Handle Assembly
Ford 1981-On

UNIT PACKAGE: 25



11620

(GM: 9436175;
Ford: 385189-S100;
Chrys: 6031115)

"Peel-Type" Rivet
1/4" Diameter
Grip: 1/32" - 9/64"
Flange Diameter: 1/2"
Aluminum Rivet
Steel Mandrel
Window Regulators
GM, Ford & Chrysler
1971-On

Use with Auveco Tool
11817 & Nose Piece
11853

UNIT PACKAGE: 25

16837

Same as 11620 Except For
Packing

UNIT PACKAGE: 50

Use 11817 Rivet Gun

With 11853

Nose Piece

(Page 242)

To Set All 1/4"

"Peel-Type" Rivets



15684

(20713843)

"Peel-Type" Rivet
1/4" Diameter
Grip 7/64" - 11/64"
Flange Diameter 1/2"
Recess Under Head
Aluminum Rivet,
Steel Mandrel
Used On Window
Regulators
& Door Lock Assemblies
GM A & J Cars

UNIT PACKAGE: 25

Sec. 14

"PEEL-TYPE" SPECIALTY RIVETS

Rivets Are Listed In Columns By Diameter Then By Flange Diameter & Lastly By Minimum Grip



12655

(GM: 9437486;
Chry: 6032926)

"Peel-Type" Rivet
1/4" Diameter
Grip: 9/64" - 3/16"
Flange Diameter: 1/2"
Aluminum Rivet
Steel Mandrel
Window Regulators
GM 1981-On

UNIT PACKAGE: 25



11621

(Ford: 385323-S100;
Chrys: 6031091;
GM: 9437938)

"Peel-Type" Rivet
1/4" Diameter
Grip: 33/64" - 19/32"
Flange Diameter: 1/2"
Aluminum Rivet
Steel Mandrel
Window Regulator
GM, Ford & Chrysler
1976-On

Use with Auveco
Tool 11817 &
Nose Piece 11853

UNIT PACKAGE: 10



19420

(W525174S)

"Peel-Type" Rivet
1/4" Diameter
Grip: 13/64"-13/32"
Flange Diameter: 5/8"
Aluminum Rivet
Steel Mandrel (Zinc)
Door Handle
Ford Ranger
1997-On

UNIT PACKAGE: 25



14486

(GM: 9437486;
Chry: 6032926)

"Peel-Type" Rivet
1/4" Diameter
Grip: 9/64" - 3/16"
Flange Diameter: 1/2"
Aluminum Rivet
Steel Mandrel
Used On Window
Regulators,
Quarter Vent Handle
Assemblies & Electrical Door
Lock Linkage.
GM & Chrysler 1981-On

UNIT PACKAGE: 25



12658

(GM: 12338153,
20184399;
Ford: 389268-S100)

"Peel-Type" Rivet
1/4" Diameter
Grip 11/16" - 3/4"
Flange Diameter 1/2"
Aluminum Rivet
Steel Mandrel
Window Regulator
GM & Ford 1979-On

UNIT PACKAGE: 25



19456

(W525175-S)

"Peel-Type" Rivet
1/4" Diameter
Grip: 25/64" - 21/32"
Flange Diameter: 5/8"
Aluminum Rivet
Steel Mandrel (Zinc)
Front Door Window
Ford Continental,
Crown Victoria,
Explorer, Grand Marquis,
Mark VIII, Mustang,
Ranger, Sable,
Taurus, Town Car
& Windstar
1996-On

UNIT PACKAGE: 15



20402

(9437643)

"Peel-Type" Rivet
1/4" Diameter
Grip: 3/16" - 1/4"
Flange Diameter: 1/2"
Aluminum Rivet
Steel Mandrel (Zinc)
Window Regulator
Saturn
1993 - On

UNIT PACKAGE: 25



18396

(N808594-S100)

"Peel-Type" Rivet
1/4" Diameter
Grip: 1/8"-5/16"
Flange Diameter: 5/8"
Aluminum Rivet
Steel Mandrel
(Zinc & Yellow)
Door Lock Actuator
Ford

UNIT PACKAGE: 25



18167

(Ford: N804193-S100;
GM: 9441592, 15672713)

"Peel-Type" Rivet
1/4" Diameter
Grip: 3/32"-9/64"
Flange Diameter: 3/4"
Aluminum Rivet (Black)
Steel Mandrel
Front Door Handle
& Door Lock Actuator
Tempo, Topaz, T-Bird
& Cougar 1984-On
Rocker Panel Moulding
Chevrolet Beretta & Corsica
1996 - 92

UNIT PACKAGE: 25

"PEEL-TYPE" SPECIALTY RIVETS

Sec. 14

Rivets Are Listed In Columns By Diameter Then By Flange Diameter & Lastly By Minimum Grip



19458
(N808689-S417)
"Peel-Type" Rivet
1/4" Diameter
Grip: 1/8"-21/64"
Flange Diameter: 3/4"
Aluminum Rivet (Black)
Aluminum Mandrel
Door Lock Actuator
Ford Continental,
Crown Victoria,
F Series Truck,
Grand Marquis,
Mark VII, Mustang,
Ranger, Sable, Taurus,
Town Car & Windstar
1995-On
UNIT PACKAGE: 10

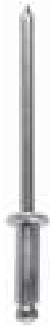

18500
1/8" Diameter
Grip: 3/16"-1/4"
Flange Dia: 3/16"
Aluminum Rivet
Aluminum Mandrel
Trim Moulding Attachment
UNIT PACKAGE: 100



17408
(N803933-S101)
1/8" Diameter
Grip: 13/64"-9/32"
Flange Diameter: 15/64"
Closed End
Aluminum Rivet (Black)
Aluminum Mandrel (Black)
Luggage Rack
Ford
UNIT PACKAGE: 50



20987
(Not Available From O.E.M.)
3/32" Diameter
Shoulder Diameter: 1/8"
Grip: Up To 3/32"
Flange Diameter: 3/16"
Aluminum Rivet
Aluminum Mandrel
Replaces welded on studs
for attaching stud style
moulding clips
UNIT PACKAGE: 25



11104 U.P.: 100
11105 U.P.: 500
11106 U.P.: 1000
(Ford: 383229-S)
Dia: 1/8"
Grip: 3/16"-1/4"
Flange Dia: 3/16"
Stainless Steel Rivet
Steel Mandrel



17469
(375936-S)
Diameter: 1/8"
Grip: 1/32"-1/8"
Flange Dia: 1/4"
Stainless Steel Rivet
Stainless Steel Mandrel
Attaches Body Side Mouldings
(Sets flush, does not leave a raised
stud)
UNIT PACKAGE: 100

REPLACES WELDED STUDS
ON BODY PANELS.
USE AUVECO RIVET GUN 7915
& NOSE PIECE 7981.



7981
Rivet Gun Nose Piece
Used to set Auveco
Rivet 11104
With Rivet Gun 7915
UNIT PACKAGE: 1



21418
(6508540-AA)
1/8" Diameter
Grip: 1/32" - 3/16"
Flange Diameter: 1/4"
Black Aluminum Rivet
Steel Mandrel (Zinc)
Chrysler General Purpose
UNIT PACKAGE: 25



10658
Dia: 3/32"
Grip: 1/8"-1/4"
Flange Dia: 3/16"
Aluminum Rivet
Aluminum Mandrel
REPLACES WELDED STUDS
ON BODY PANELS.
UNIT PACKAGE: 100



20788
(90269-04051, 90269-A0006)
1/8" (3.2mm) Diameter
Grip: 3/64" - 1/8"
(1.2mm - 3.4mm)
Flange Diameter: 15/64" (6mm)
Aluminum Rivet
With Plastic Cap
Steel Mandrel
Lexus
1998 - On
UNIT PACKAGE: 10



18303
1/8" Diameter
Grip: 1/16"-1/8"
Flange Diameter: 1/4"
Aluminum Rivet (Black)
Aluminum Mandrel
Attachment Of Rear
Window Trim
Moulding
Ford Explorer
1990-On
UNIT PACKAGE: 50



18499
1/8" Diameter
Grip: 1/8"-3/16"
Flange Dia: 3/16"
Aluminum Rivet
Aluminum Mandrel
Trim Moulding Attachment
UNIT PACKAGE: 100

Sec. 14**"PEEL-TYPE" SPECIALTY RIVETS**

Rivets Are Listed In Columns By Diameter Then By Flange Diameter & Lastly By Minimum Grip

**17470**
(378527)Diameter: 1/8"
Grip: 1/8"-3/16"
Flange Dia: 1/4"
Aluminum Rivet
Aluminum Mandrel
Attaches Climate Controls
Ford

UNIT PACKAGE: 50

**19657**
(6034848)1/8" Diameter
Grip: 1/32"-3/16"
Flange Diameter: 5/16"
Aluminum Rivet
Steel Mandrel
(Zinc & Yellow)
Rocker Panel & Cladding
Chrysler LH Series
1993-On

UNIT PACKAGE: 50

**12656**
(20325696)Dia: 1/8"
Grip: 1/8" - 3/16"
Flange Dia: 5/16"
Aluminum Rivet
Steel Mandrel
Rear Window Gasket
Attachment
GM 1981-On

UNIT PACKAGE: 50

**17467**
(375203S)Diameter: 1/8"
Grip: 1/8"-3/16"
Flange Dia: 1/4"
Stainless Steel Rivet;
Steel Mandrel
Attaches Body Side
Moulding Ret.
(Sets flush, does not
leave a raised stud)
Ford

UNIT PACKAGE: 100

**20787**
(90269-04006)1/8" (3.2mm) Diameter
Grip: 3/64" - 5/32"
(1.2mm - 4.0mm)
Flange Diameter:
5/16" (8mm)
Aluminum Rivet
With Plastic Cap
Steel Mandrel
Lexus
1998 - On

UNIT PACKAGE: 10

**20628**
(90269-04050)1/8" (3.2mm) Diameter
Grip: 5/32" - 5/16"
(4mm - 8mm)
Flange Diameter:
5/16" (8mm)
Aluminum Rivet
With Plastic Cap
Steel Mandrel
Windshield, Side &
Trunk Moulding
Lexus GS300, 400, 430
& SC430
1998 - On

UNIT PACKAGE: 15

**21114**
(11610210)1/8" Diameter
Grip: 5/32" - 5/16"
Flange Diameter: 1/4"
Aluminum Rivet
Aluminum Mandrel
Rear Bumper Fascia
Chevrolet Equinox
2005 - On

UNIT PACKAGE: 50

**20627**
(90269-04053)1/8" (3.2mm) Diameter
Grip: 3/64" - 3/16"
(1mm - 4.8mm)
Flange Diameter:
5/16" (8mm)
Aluminum Rivet (Black)
With Plastic Cap
Steel Mandrel (Black)
Mouldings
Toyota Landcruiser
1998 - On

UNIT PACKAGE: 10

**17615**
(6032856)Diameter: 1/8"
Grip: 3/16"-3/8"
Flange Diameter: 5/16"
Aluminum Rivet (Black)
Steel Mandrel
Body Side Moulding
& Universal Applications
Chrysler

UNIT PACKAGE: 50

**19202**1/8" Diameter
Grip: 3/16"-1/4"
Flange Diameter: 1/4"
Aluminum Rivet (Black)
Aluminum Mandrel
GM & General Purpose

UNIT PACKAGE: 100

**19406**
(6035414)Diameter: 1/8"
Grip: 1/16"-1/4"
Flange Diameter: 5/16"
Aluminum Rivet
Steel Mandrel (Zinc)
Cladding To
Fender Attachment
Chrysler Concorde,
Eagle & Intrepid
1997-On

UNIT PACKAGE: 50

**18304**1/8" Diameter
Grip: 1/16"-1/8"
Flange Diameter: 3/8"
Aluminum Rivet (Black)
Steel Mandrel
Attachment Of Door
Glass Moulding
Ford 1993-On

UNIT PACKAGE: 50

SPECIALTY RIVETS

Rivets Are Listed In Columns By Diameter Then By Flange Diameter & Lastly By Minimum Grip



21320
(90269-03064)
Rocker Moulding
3.2mm (1/8") Diameter
Grip: 1.6mm-3.2mm
(1/16"-1/8")
Flange Diameter: 9.5mm (3/8")
Aluminum Rivet
Aluminum Mandrel
Black Flange
Lexus ES 300 & Others
2002 - On
UNIT PACKAGE: 15



21082
(75547-51021)
1/8" (3.2mm) Diameter
1/4" (6.3mm) Nylon Shoulder
Diameter
Grip: 1/32" - 1/16"
(.8mm - 1.5mm)
Flange Diameter:
13/32" (10.3mm)
Aluminum Rivet
With Plastic Cap
Steel Mandrel
Windshield
Lexus IS 250, IS 350 & IS F
2006 - On
Toyota 2002 - On
UNIT PACKAGE: 15



21113
(01515-0009U)
Split-Type Rivet
5/32" (4mm) Diameter
Grip: 3/64" - 9/32"
(1mm - 7mm)
Flange Dia: 5/16" (8mm)
Aluminum Rivet (Black)
Aluminum Mandrel
Bumper
Nissan Pathfinder
2006 - On
UNIT PACKAGE: 25



16834
(N805759-S100)
Diameter: 1/8"
Grip: 1/8"-3/16"
Flange Diameter: 3/8"
Aluminum Rivet (Black)
Aluminum Mandrel
Windshield Side Rail
Ford T-Bird &
Mercury Cougar
1989-On
UNIT PACKAGE: 50



18461
(Ford: N807620-S100;
GM: 10131511)
Split-Type Rivet
5/32" Diameter
Grip: 3/64"-1/4"
Flange Diameter: 5/16"
Aluminum Rivet (Black)
Aluminum Mandrel
Wheel Openings
Lincoln 1994-On
Bumper Cover,
Grille & Rocker Moulding
GM 1997 - On
UNIT PACKAGE: 25



20383
(90084-26002)
5/32" (4mm) Diameter
Grip: 1/16" - 1/4"
(1.6mm - 6.3mm)
Flange Diameter:
5/16" (8mm)
Aluminum Rivet
Aluminum Mandrel
Door Window Moulding
Toyota Camry 1997 - On
UNIT PACKAGE: 50



16686
(9432552)
Dia: 1/8"
Grip: 1/8" - 3/16"
Flange Dia: 3/8"
Aluminum Rivet
Steel Mandrel
Large Flange
Multi-Purpose Rivet
GM
1978-On
UNIT PACKAGE: 100



20971
(003-990-94-97)
Split-Type Rivet
5/32" (4mm) Diameter
Grip: 3/64" - 9/32"
(1mm - 7mm)
Flange Diameter:
5/16" (8mm)
Aluminum Rivet
Aluminum Mandrel
Mercedes-Benz
2004 - On
UNIT PACKAGE: 25



16687
(GM: 9432137;
Chrys: 6032138)
Diameter: 5/32"
Grip: 1/8"-3/16"
Flange Diameter: 5/16"
Aluminum Rivet,
Steel Mandrel
Countersunk Head
Trunk Lock
Swivel Emblem Rivet
Requires nosepiece 16688
GM 1973-On
UNIT PACKAGE: 25



19419
(N811460-S100)
1/8" Diameter
Grip: 1/8"-3/16"
Flange Diameter: 3/8"
Steel Rivet (Black)
Steel Mandrel
(Zinc & Yellow)
Door Moulding
Ford Taurus
1996-On
UNIT PACKAGE: 15



16688
Rivet Gun Nosepiece
Used to set Auveco Rivet 16687
UNIT PACKAGE: 1

Rivets Are Listed In Columns By Diameter Then By Flange Diameter & Lastly By Minimum Grip



20629

(6036148-AA)

Split-Type Rivet
5/32" Diameter
Grip: 3/64" - 1/4"
Flange Diameter: 7/16"
Aluminum Rivet (Black)
Aluminum Mandrel
Front Bumper, Trim Panel,
Instrument Panel &
Running Boards
Chrysler
1999 - On

UNIT PACKAGE: 25



15187

(N804583S)
Black Nylon

Cowl Vent Grille
Retainer Rivet
5/32" (4mm) Diameter
Grip: 15/64" - 13/32"
(6mm-10.5mm)
Flange Size: 11/32" x 5/8"
(8.5mm x 15.5mm)
Ford Aerostar 1986-On

UNIT PACKAGE: 25



16864

(10125439)

Split-Type Rivet
Dia: 3/16"
Grip: 3/64"-11/32"
Flange Dia: 3/8"
Aluminum Rivet (Black)
Aluminum Mandrel
Moulding Attachment
APV Vans 1990-On

UNIT PACKAGE: 25



17468

(16715497)

Dia: 5/32"
Grip: 3/64"-1/4"
Flange Dia: 15/32"
Aluminum Rivet
Steel Mandrel
Attaches Support
Rails To Load
Floor
GM

UNIT PACKAGE: 50



18169

(15956062)

3/16" Diameter
Grip: 1/8"-1/4"
Flange Diameter: 11/32"
Aluminum Rivet &
Steel Mandrel
Door Assembly
GM Trucks
C, K Models
1994-On

UNIT PACKAGE: 25



20830

(N-904-374-01)

3/16" (4.8mm) Diameter
Grip: 1/16" - 1/4"
(1.6mm-6.4mm)
Flange Diameter:
3/8" (10mm)
Aluminum Rivet
Steel Mandrel
(Zinc & Yellow)
Inner Fender
Volkswagen

UNIT PACKAGE: 25



19376

(979878-6)

5/32" (4mm) Diameter
Grip: 1/8"-11/32"
(3mm-8.5mm)
Flange Diameter: 15/32"
(12mm)
Aluminum Rivet
(Black Polyethylene
Coating)
Aluminum Mandrel
Bumper & Wheel Housing
Volvo 1993-On

UNIT PACKAGE: 15



19514

(10125439, 10201332)

Split-Type Rivet
3/16" Diameter
Grip: 3/64"-15/64"
Flange Diameter: 3/8"
Aluminum Rivet (Black)
Aluminum Mandrel
Door Actuator, Door,
Body & Fender
Moulding and Dash
Panel Insulation
Buick Regal,
Chev. Lumina APV,
K & T Trucks,
Olds Silhouette and
Pontiac Trans Sport
1990-On

UNIT PACKAGE: 25



18912

(22585836,
22641917)

3/16" Diameter
Grip: 1/16" - 17/64"
Flange Diameter: 3/8"
Steel Rivet (Black)
Steel Mandrel (Zinc)
Rear Side Door
Outside Handle Attachment
Cadillac DeVille & Seville,
Chevrolet Cavalier And
Pontiac Sunfire 1994-On

UNIT PACKAGE: 25



17006

(N900-845-01)

Diameter: 5/32"
Grip: 1/4" - 3/8"
Flange Dia. 15/32"
Aluminum Rivet (Black)
Steel Mandrel
Wheel Opening
Moulding Attachment
Jetta, Rabbit & Golf

UNIT PACKAGE: 25



19459

(384432-S)

3/16" Diameter
Grip: 1/16"-1/8"
Flange Diameter: 3/8"
Aluminum Rivet
Steel Mandrel
Outer Moulding
Ford F Series & Villager
And Nissan Quest
1995-On

UNIT PACKAGE: 25

SPECIALTY RIVETS

Sec. 14

Rivets Are Listed In Columns By Diameter Then By Flange Diameter & Lastly By Minimum Grip

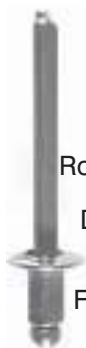

21184

(003-990-24-97)

Door Handle, Air Bag,
Rocker Moulding & Window
Regulator Rivet
Diameter: 3/16" (4.8mm)
Grip: 1/16" - 1/8"
(1.6mm - 3.2mm)
Flange Dia.: 3/8" (9.5mm)
Steel Rivet,
Steel Mandrel
Mercedes-Benz
1998 - On

UNIT PACKAGE: 100



17410

(390428-S100)

3/16" Diameter
Grip: 3/8"-1/2"
Flange Diameter: 3/8"
Closed End
Aluminum Rivet (Black)
Aluminum Mandrel
(Black)
Luggage Rack
Ford

UNIT PACKAGE: 25



18927

(22569178,
22579423)

Split-Type Rivet
3/16" Diameter
Grip: 5/16" - 7/16"
Flange Diameter: 7/16"
Aluminum Rivet
Steel Mandrel (Zinc)
Front & Rear Door
Window Sash Attachment
Buick Skylark, Chevrolet Cavalier,
Olds Achieva & Pontiac Grand Am
1992-On

UNIT PACKAGE: 25



21439

(11589111)

M4.8 (3/16") Diameter
Grip: 1.5mm - 6mm
(1/16" - 15/64")
Flange Dia.: 9mm (3/8")
Steel Rivet, Steel Mandrel
Cadillac CTS; Chevrolet
Colorado & Equinox and
GMC Canyon
& Terrain 2004 - On

UNIT PACKAGE: 50



19515

(15704030)

3/16" Diameter
Grip: 3/16"-3/8"
Flange Diameter: 25/64"
Aluminum Rivet (Black)
Steel Mandrel
(Zinc & Yellow)
Body Moulding,
Bumper Fascia,
Hood Prop Rod and
Window Hinge
Chev. Beretta, Camaro,
Corsica & Trucks,
Olds Silhouette,
Pontiac Firebird, Grand Am and
Trans Sport
1992-On

UNIT PACKAGE: 25



18244

(GM: 15614774)

Split-Type Rivet
3/16" Diameter
Grip: 3/16"-3/8"
Flange Diameter: 29/64"
Aluminum Rivet (Black)
Aluminum Mandrel
For Camper Style
Mirrors On GM Trucks

UNIT PACKAGE: 10



21455

(68048610-AA)

Split-Type Rivet
3/16" (4.8mm) Diameter
Grip: 1/8" - 3/8"
(3mm - 9.5mm)
Flange Dia.: 15/32" (12mm)
Aluminum Rivet
Aluminum Mandrel
Chrysler 2008 - On

UNIT PACKAGE: 15



17121

(GM: 25618730;
Ford: N805592-S100)

Split-Type Rivet
Dia: 3/16"
Grip: 5/64"-15/64"
Flange Dia: 7/16"
Aluminum Rivet (Black)
Aluminum Mandrel
Wheel House Moulding
& General Purpose

UNIT PACKAGE: 25

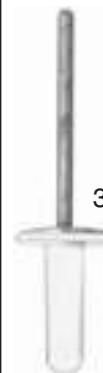

21046

(90269-05065)

3/16" (5mm) Diameter
Grip: 5/32" - 9/32"
(4mm - 7mm)
Flange Diameter:
1/2" (13mm)
Aluminum Rivet
With Plastic Cap
Steel Mandrel
Bumpers & General Purpose
Lexus
2004 - On

UNIT PACKAGE: 10



18329

(3828472)

3/16" Diameter
Grip: 1/4"-3/8"
Flange Dia.: 3/8"
Aluminum Rivet (Black)
Aluminum Mandrel
Attachment Of Front
Fender Lower
Rocker Moulding
Chevrolet Astro & GMC Safari
Mini-Vans 1995-On

UNIT PACKAGE: 50

Sec. 14

SPECIALTY RIVETS

Rivets Are Listed In Columns By Diameter Then By Flange Diameter & Lastly By Minimum Grip**



17641

(9442361, 25609048)

Dia: 3/16"
Grip: 3/64"-13/64"
Flange Dia: 9/16"
Aluminum Rivet (Black)
Steel Mandrel (Zinc)
Used In Place Of Screws
When Attaching New Catalytic
Converter Heat Shield
Buick LeSabre & Roadmaster,
Cadillac Brougham and
Oldsmobile 98 & 88
1986-On

UNIT PACKAGE: 25



20626

(90269-05054)

3/16" (5mm) Diameter
Grip: 1/8" - 5/16"
(3mm - 8mm)
Flange Diameter: 9/16"
(14mm)
Aluminum Rivet
With Plastic Cap
Steel Mandrel
Windshield Side Moulding
& Gas Filler Cap
Toyota Camry & Sienna
1997 - On

UNIT PACKAGE: 10



20741

(11516807)

Split-Type Rivet
3/16" (4.8mm) Diameter
Grip: 3/64" - 23/64" (1mm-9mm)
Flange Diameter: 5/8" (16mm)
Aluminum Rivet (Black)
Aluminum Mandrel
Bumper Fascia & General Purpose
GM
1990 - On

UNIT PACKAGE: 25

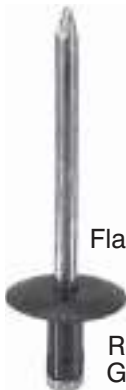

18749

(9439559,
21021319)

3/16" Diameter
Grip: 1/16"-1/4"
Flange Diameter: 9/16"
Aluminum Rivet
(Black)
Steel Mandrel
Rocker Panel Cover
GM Saturn 1991-On

UNIT PACKAGE: 50



14127

(388664-S100)

Dia: 3/16"
Grip: 3/8"-1/2"
Flange Dia: 9/16"
Aluminum Rivet (Black)
Aluminum Mandrel
Fascia & Bumper
Ford 1982-On

UNIT PACKAGE: 25



19460

(385974-S)

3/16" Diameter
Grip: 3/16"-1/4"
Flange Diameter: 5/8"
Aluminum Rivet
Steel Mandrel
General Purpose
Ford Econoline
& Windstar
1995-On

UNIT PACKAGE: 50

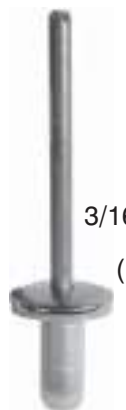

20834

(90269-06013)

3/16" (4.8mm) Diameter
Grip: 1/16" - 1/4"
(1.6mm - 6.35mm)
Flange Dia:
9/16" (14mm)
Aluminum Rivet
With Plastic Cap
Steel Mandrel
Gas Filler Door
Toyota Camry & Lexus IS300
2001 - On

UNIT PACKAGE: 15



20740

(22638717)

Split-Type Rivet
3/16" (4.8mm)
Diameter
Grip: 3/64" - 23/64"
(1mm - 9mm)
Flange Diameter:
5/8" (16mm)
Aluminum Rivet
Aluminum Mandrel
Bumper Fascia & General Purpose
GM 1987 - On

UNIT PACKAGE: 25



18168

(9433186)

3/16" Diameter
Grip 1/4"-3/8"
Flange Diameter: 5/8"
Steel Rivet (Zinc)
Steel Mandrel
Front & Rear Bumper
GM Saturn 1991-On

UNIT PACKAGE: 50

SPECIALTY RIVETS

Sec. 14

Rivets Are Listed In Columns By Diameter Then By Flange Diameter & Lastly By Minimum Grip



12657
(9439719)

Dia: 3/16"
Grip: 1/4"-3/8"
Flange Dia: 5/8"
Steel Rivet (Black)
Steel Mandrel
Attaches Fascia To
Underside Bumper
GM 1981-On

UNIT PACKAGE: 50



18935
(10160960)

3/16" Diameter
Grip: 1/2" - 25/32"
Flange Dia.: 5/8"
Aluminum Rivet
Steel Mandrel (Zinc)
Liftgate Strut Gate
Side Bracket
Lumina APV, Silhouette
& Trans Sport 1992-On

UNIT PACKAGE: 25



21124
(11610383)

1/4" Diameter
Grip: 1/64" - 1/8"
Flange O.D.: 1/2"
Steel Rivet
(Zinc)
Steel Mandrel
Step Bumper
GM Silverado &
Sierra Pick-Ups
2007 - On

UNIT PACKAGE: 25



16940

(GM: 2085119,
3533539,
3540161;
Not Supplied By
Chrysler O.E.M.)

3/16" Diameter
Grip: 1/2" - 5/8"
Flange Diameter: 5/8"
Aluminum Rivet & Mandrel
Glass Stop/Roller Rivet
Chrysler
Front Bumper
Fascia Lower Deflector
Cadillac 1993 - 87

UNIT PACKAGE: 25



17977

(Not Supplied
By O.E.M.)

3/16" Diameter
Grip: 5/8"-3/4"
Flange Diameter: 5/8"
Aluminum Rivet & Mandrel
Glass Stop/Roller Rivet
Chrysler

UNIT PACKAGE: 25



21373
(W710079-S300)

1/4" (6.3mm) Dia.
Grip: 1/64" - 7/32" (.4mm - 5.5mm)
Flange Diameter: 3/4" (19mm)
Alum. Rivet & Mandrel
Attaches Power Lock Motor/Solenoid
To Front and Rear Doors On Ford
2009 - On

UNIT PACKAGE: 10



17466
(N905150-S)

Diameter: 3/16"
Grip: 1/2"-5/8"
Flange Dia: 5/8"
Aluminum Rivet
Steel Mandrel
Attaches License
Plate Bracket
Ford

UNIT PACKAGE: 25



19111
(N807168-S)

3/16" Diameter
Grip: 11/16"-13/16"
Flange Diameter: 3/4"
Aluminum Rivet
Aluminum Mandrel
Grille & Bumper
Ford Windstar 1995-On

UNIT PACKAGE: 25



18889
(22643056)

1/4" Diameter
Grip: 1/16" - 5/32"
Flange Diameter: 1/2"
Steel Rivet
Steel Mandrel (Zinc &
Yellow Dichromate)
Door Window Regulator
Buick Skylark, Chev. Cavalier,
Olds Achieva & Aurora, And
Pontiac Grand Am & Sunfire
1995-On

UNIT PACKAGE: 25

Rivets Are Listed In Columns By Diameter Then By Flange Diameter & Lastly By Minimum Grip



21315

(90269-A0005)

1/4" (6.3mm) Dia.
Grip: 1/16" - 3/16"
(1.6mm - 4.8mm)
Flange Dia.: 1/2" (13mm)
Black Aluminum Rivet
Steel Mandrel
Fuel Door & General Purpose
Toyota 2007 - On

UNIT PACKAGE: 10



16939

(10157547)

1/4" Diameter
Grip: 5/64" - 3/8"
Flange Diameter: 1/2"
Aluminum Rivet,
Steel Mandrel
(Yellow Dichromate Coated)
Front Door Window Regulator
GM APV Vans 1990-On

UNIT PACKAGE: 10



12654

(372820-S36, S40)

Dia: 1/4"
Grip: 1/8"-1/4"
Flange Dia: 1/2"
Steel Rivet
(Zinc & Gold Chrome)
Steel Mandrel
Front Bumper Assembly
Ford 1979-On

UNIT PACKAGE: 25



18938

(2024778)

1/4" Diameter
Grip: 1/16"-1/4"
Flange Dia.: 1/2"
Steel Rivet (Zinc)
Steel Mandrel (Zinc)
Front Side Door
Window Regulator
Chevrolet Lumina APV,
Olds Silhouette & Pontiac
Trans Sport 1990-On

UNIT PACKAGE: 25



18810

(6033688)

1/4" Diameter
Grip: 7/64"-3/16"
Flange Dia.: 1/2"
Steel Rivet
(Zinc & Yellow)
Steel Mandrel
(Zinc & Yellow)
Glass & Frame Assembly
And Floor Pan
Reinforcement Attachment
Dodge Shadow, Plymouth
Sundance
& Jeep Cherokee
1991-On

UNIT PACKAGE: 25



21142

(11519023)

1/4" Diameter
Grip: 3/16" - 17/64"
Flange Diameter: 1/2"
Steel Rivet &
Steel Mandrel
Buick Lucerne,
Chevrolet
Cobalt & Vans
Pontiac G5 and
Saturn Aura
2003 - On

UNIT PACKAGE: 10



21115

(11609731)

1/4" Diameter
Grip: 1/16" - 19/64"
Flange Diameter: 1/2"
Steel Rivet
Steel Mandrel
Fuel Tank Mounting
GM
1997 - On

UNIT PACKAGE: 25



21286

(004-990-16-97)

Dia.: 1/4" (6.3mm)
Grip: 3/16" - 17/64"
(4.80mm - 6.80mm)
Flange Dia.: 1/2" (13mm)
Steel Rivet, Steel Mandrel
Mercedes Benz 2008 - On

UNIT PACKAGE: 10



19396

(N808426-S100)

1/4" Diameter
Grip: 1/8"-1/4"
Flange Diameter: 1/2"
Aluminum Rivet (Black)
Aluminum Mandrel
Bumper Fascia
Ford Taurus & Sable
1996-On

UNIT PACKAGE: 25



21245

(W705297-S300)

Split-Type Rivet
1/4" Diameter
Grip Range: 3/16" - 3/8"
Flange Diameter: 11/16"
Aluminum Rivet
Aluminum Mandrel
Bumper Cover
Ford Fusion
2009 - On

UNIT PACKAGE: 15

Rivets Are Listed In Columns By Diameter Then By Flange Diameter & Lastly By Minimum Grip



21440
(Not Available From O.E.M.)
Closed End Rivet
1/4" Diameter
Grip Range: 1/4" - 3/8"
Flange Diameter: 1/2"
Aluminum Rivet,
Steel Mandrel
General Purpose

UNIT PACKAGE: 25



19516
(N804851-S100)
Split-Type Rivet
1/4" Diameter
Grip: 3/64"-1/4"
Flange Dia.: 9/16"
Aluminum Rivet
(Black)
Aluminum Mandrel
Front Bumper
Ford Taurus
1996-On

UNIT PACKAGE: 15



18331
(N805995-S100,
W701566-S417)
Diameter: 1/4"
Grip: 1/32"-7/32"
Flange Dia.: 3/4"
Aluminum Rivet (Black)
Aluminum Mandrel (Yellow)
Attachment Of Power Door Lock
Actuator
Mustang & Lincoln
Continental 1994-On

UNIT PACKAGE: 10



18171
(10204265)
1/4" Diameter
Grip: 1/2"-5/8"
Flange Dia.: 1/2"
Aluminum Rivet
Aluminum Mandrel
Trunk Lock Cylinder
Chevrolet Camaro
1994-On

UNIT PACKAGE: 15



20170
(11518091)
Split-Type Rivet
Diameter: 1/4"
Grip: 3/16"-3/8"
Flange Dia.: 9/16"
Aluminum Rivet
Aluminum Mandrel
Front & Rear
Bumper Fascia
Saturn
2000-On

UNIT PACKAGE: 15



17640
(3540146,
3548011)
1/4" Diameter
Grip: .070"-.083"
Flange Dia.: 3/4"
Steel Rivet
Steel Mandrel
(Zinc & Yellow
Dichromate)
Front Door Window
Channel Retainer Rivet
Buick Riviera, Cadillac DeVille &
Eldorado And Olds Toronado
1993-On

UNIT PACKAGE: 15



18170
(10204266)
1/4" Diameter
Grip: 3/4"-1"
Flange Diameter: 1/2"
Aluminum Rivet
Aluminum Mandrel
Trunk Lock Cylinder
Pontiac Firebird
1994-On

UNIT PACKAGE: 10



17639
(Ford: N806830-S100;
Chrys: 6035201)
Split-Type Rivet
Diameter: 1/4"
Grip: 3/16"-3/8"
Flange Dia: 11/16"
Aluminum Rivet
(Black)
Aluminum Mandrel
Attachment of
Bumper Cover
To Bumper &
Front License
Plate Bracket To
Bumper Cover
Ford 1992-On
Air Dam To Fascia
Chrysler 1993-On

UNIT PACKAGE: 15



12652
(388442-S100)
Dia: 1/4"
Grip: 1/8"-1/4"
Flange Dia: 3/4"
Steel Rivet (Black)
Steel Mandrel
Bumper Assembly
Escort & Lynx 1981-On

UNIT PACKAGE: 25

19263
Same As 17639
Except For Packing
UNIT PACKAGE: 25



**Straight Shank - Black Finish
135° Split Point**

Auveco Part No.	Unit Pkg.	Size	Dec. Equiv.	Flute Length	Overall Length
13039	5	3/32"	.0938	1-1/4"	2-1/4"
13040	5	7/64"	.1094	1-1/2"	2-5/8"
13041	5	1/8"	.1250	1-5/8"	2-3/4"
13095	5	30	.1285	1-5/8"	2-3/4"
13042	5	9/64"	.1406	1-3/4"	2-7/8"
13043	5	5/32"	.1562	2"	3-1/8"
13044	5	11/64"	.1719	2-1/8"	3-1/4"
13045	5	3/16"	.1875	2-5/16"	3-1/2"
13072	5	7	.2010	2-7/16"	3-5/8"
13095	5	30	.1285	1-5/8"	2-3/4"
13046	5	13/64"	.2031	2-7/16"	3-5/8"
13047	5	7/32"	.2188	2-1/2"	3-3/4"
13048	5	15/64"	.2344	2-5/8"	3-7/8"
13049	5	1/4"	.2500	2-3/4"	4"
13050	5	17/64"	.2656	2-7/8"	4-1/8"
13051	5	9/32"	.2812	2-15/16"	4-1/4"
13052	5	19/64"	.2969	3-1/16"	4-3/8"
13053	5	5/16"	.3125	3-3/16"	4-1/2"
13054	5	21/64"	.3281	3-5/16"	4-5/8"
13055	5	11/32"	.3438	3-7/16"	4-3/4"
13056	5	23/64"	.3594	3-1/2"	4-7/8"
13057	5	3/8"	.3750	3-5/8"	5"
13058	5	25/64"	.3906	3-3/4"	5-1/8"
13059	5	13/32"	.4062	3-7/8"	5-1/4"
13060	5	27/64"	.4219	3-15/16"	5-3/8"
13061	5	7/16"	.4375	4-1/16"	5-1/2"
13062	5	29/64"	.4531	4-3/16"	5-5/8"
13063	5	15/32"	.4688	4-5/16"	5-3/4"
13064	5	31/64"	.4844	4-3/8"	5-7/8"
13065	3	1/2"	.5000	4-1/2"	6"

**COBALT STEEL
SPOT WELD DRILLS**



Auveco Part No.	Unit Pkg.	Size	Flute Length	Overall Length
20479	3	8mm (5/16")	27mm (1-1/16")	58mm (2-1/4")
20480	3	10mm (3/8")	27mm (1-1/16")	58mm (2-1/4")

**High Speed Jobber Length
Drill Set**

Metal Drill Indexes



13136

Jobbers Length
Straight Shank
135° Split Point
Blue/Bright Finish
Sizes 1/16" thru
1/2" by 64th
29 Pieces

UNIT PACKAGE: 1 Set



**Screw Machine Length Drills
Blue Finish - Straight Shank
135° Split Point**

Auveco Part No.	Unit Pkg.	Size	Dec. Equiv.	Flute Length	Overall Length
13120	5	1/16"	.0625	5/8"	1-5/8"
13121	5	5/64"	.0781	11/16"	1-11/16"
13124*	5	1/8"	.1250	7/8"	1-7/8"
13128	5	3/16"	.1875	1-1/8"	2-3/16"
13132	5	1/4"	.2500	1-3/8"	2-1/2"
13133	5	5/16"	.3125	1-5/8"	2-13/16"
13134	2	3/8"	.3750	1-13/16"	3-1/8"

* for 1/8" Pop Rivets



Double-End Drill Bit
1/8" (.125) Dia., 2" Length
135° Split Point

12676

Black Finish

UNIT PKG: 5

NOTE: AuvecoPak part numbers are the same as standard Auveco part numbers with an "AP" prefix. Thus AP11146 is the AuvecoPak version of 11146.



AUVECOPAK

The AuvecoPak merchandisers (**AP448S** and **AP448L**) provide **448** of the fastest moving, most popular automotive body hardware and specialty fasteners in a **one-price** package all on one **7-panel merchandiser**. Each panel contains 32 part numbers per side. **The AP448S (Starter Merchandiser) consists of one package each of the 448 part numbers. The AP448L (Large Assortment) includes two packages each of the 224 most popular items and one package each of the other 224 part numbers for a total of 672 packages.**

With just a glance, two attractive header signs identify the AP448 as an Auveco merchandiser, the name synonymous with automotive body hardware and specialty fasteners. An eye-catching color scheme and graphics on the front facing cards not only make the merchandiser visually appealing but at a glance they portray the contents of the merchandiser as well.

Initial set-up is as easy as 1-2-3 since the panels come **"pre-dressed"** with the AuvecoPaks already in place. Simply position the top and bottom brackets on a gondola or pegboard wall. Insert the panels into the brackets and you're ready for business.

An individual panel measures 6-1/2" (wide) x 17-1/2" (front to back) x 44-1/2" (high) – maximum coverage in minimum space. AuvecoPak 7-panel merchandisers (**AP448S** and **AP448L**) **fit on a gondola with 48" x 48" of pegboard** or on any pegboard wall.

A gondola is not included with the AP448S or the AP448L. Auveco customer service reps can recommend a source for gondolas.

The attractive green AuvecoPak packages feature eye-appealing, contemporary graphics with all the necessary application and descriptive information in **trilingual verbiage** (English, Spanish and French-Canadian) as well as locator codes that identify their location on the panels. The AuvecoPak part numbers are the same as the standard Auveco part numbers with an "AP" prefix. Thus AP11146 is the AuvecoPak version of 11146.

We've made re-ordering a snap by putting the AuvecoPak part number and a **UPC-A bar code** on the panel back-up boards beneath each hook. Then restocking the merchandiser is also quick and easy since the AuvecoPak packages contain **locator codes** that identify their specific location on the panels.



AP448S (Starter Merchandiser): one package each of 448 part numbers

AP448L (Large Merchandiser): two packages each of the 224 most popular items and one package each of the other 224 part numbers for a total of 672 packages.

"AuvecoPak" AP448 RETAIL MERCHANDISER CONTENTS

NOTE: AuvecoPak part numbers are the same as standard Auveco part numbers with an "AP" prefix. Thus AP11146 is the AuvecoPak version of 11146.



Panel T1
Retainers

- | | | | |
|---------|---------|---------|---------|
| AP10832 | AP10831 | AP11146 | AP17664 |
| AP20192 | AP11120 | AP14921 | AP14021 |
| AP11612 | AP11721 | AP15367 | AP17612 |
| AP11679 | AP19837 | AP16818 | AP12731 |
| AP18301 | AP14032 | AP14036 | AP12766 |
| AP15543 | AP20366 | AP20316 | AP11351 |
| AP20362 | AP12137 | AP15481 | AP15480 |
| AP12571 | AP12909 | AP15479 | AP15998 |



Panel T2
Retainers & Trim Panel Fasteners

- | | | | |
|---------|---------|---------|---------|
| AP15457 | AP12759 | AP15456 | AP11130 |
| AP17649 | AP12565 | AP13470 | AP18848 |
| AP11671 | AP15970 | AP12992 | AP19386 |
| AP18915 | AP11797 | AP18930 | AP17075 |
| AP19270 | AP16695 | AP15461 | AP11678 |
| AP11672 | AP13461 | AP10621 | AP12737 |
| AP11796 | AP808 | AP11863 | AP2310 |
| AP2309 | AP12134 | AP19682 | AP18114 |



Panel U1
Retaining Clips & Retainers

- | | | | |
|---------|---------|---------|---------|
| AP19114 | AP14356 | AP19729 | AP20543 |
| AP14355 | AP14291 | AP18297 | AP14736 |
| AP14737 | AP19113 | AP18842 | AP17975 |
| AP19655 | AP14738 | AP17004 | AP14163 |
| AP17339 | AP19171 | AP18877 | AP18033 |
| AP14328 | AP10744 | AP8853 | AP14016 |
| AP17162 | AP16782 | AP16784 | AP11705 |
| AP11699 | AP20248 | AP11706 | AP18353 |



Panel U2
Push-Type Retainers

- | | | | |
|---------|---------|---------|---------|
| AP12567 | AP14011 | AP14010 | AP12757 |
| AP20335 | AP20869 | AP20908 | AP20349 |
| AP19239 | AP19118 | AP20955 | AP18888 |
| AP19274 | AP20247 | AP20986 | AP19453 |
| AP19233 | AP19246 | AP20327 | AP20564 |
| AP19801 | AP19639 | AP17222 | AP20888 |
| AP17103 | AP16622 | AP13996 | AP13993 |
| AP20931 | AP20458 | AP19615 | AP20889 |



Panel V1
Push-Type Retainers

- | | | | |
|---------|---------|---------|---------|
| AP18873 | AP20632 | AP19422 | AP17216 |
| AP13994 | AP15044 | AP14019 | AP14020 |
| AP15042 | AP14696 | AP14697 | AP14260 |
| AP17379 | AP16000 | AP17632 | AP17267 |
| AP14997 | AP16858 | AP20348 | AP17439 |
| AP14992 | AP14753 | AP17472 | AP17057 |
| AP19140 | AP19739 | AP17143 | AP16835 |
| AP18119 | AP14994 | AP17144 | AP19613 |



Panel V2
Rivets

- | | | | |
|---------|---------|---------|---------|
| AP13748 | AP13755 | AP14023 | AP18108 |
| AP13751 | AP13750 | AP17101 | AP13752 |
| AP13753 | AP20788 | AP20627 | AP20834 |
| AP16834 | AP17615 | AP17006 | AP18461 |
| AP20629 | AP19376 | AP16864 | AP17121 |
| AP17410 | AP20741 | AP14127 | AP12652 |
| AP17639 | AP8309 | AP8925 | AP8931 |
| AP5753 | AP8311 | AP8301 | AP8313 |



Panel W1
Rivets, Specialty Nuts & Nylon Nuts

- | | | | |
|---------|---------|---------|---------|
| AP11620 | AP11621 | AP12655 | AP12653 |
| AP18167 | AP13007 | AP13009 | AP13008 |
| AP13004 | AP13010 | AP16253 | AP16251 |
| AP13014 | AP13016 | AP13017 | AP13232 |
| AP15326 | AP12595 | AP15335 | AP18153 |
| AP11855 | AP9829 | AP10330 | AP11691 |
| AP9862 | AP13450 | AP13960 | AP13933 |
| AP13932 | AP14274 | AP14313 | AP3682 |



Panel W2
Nylon Nuts, Screw Grommets, Thread Cutting Nuts, Push-On Retainers & Pushnut Bolt Retainers

- | | | | |
|---------|---------|---------|---------|
| AP11719 | AP8435 | AP14695 | AP20954 |
| AP19194 | AP19756 | AP20440 | AP19721 |
| AP14267 | AP19614 | AP12255 | AP15711 |
| AP3403 | AP2895 | AP8855 | AP3404 |
| AP2896 | AP2897 | AP3405 | AP10733 |
| AP2557 | AP8863 | AP8864 | AP8865 |
| AP8868 | AP8869 | AP10374 | AP10086 |
| AP10087 | AP9297 | AP9299 | AP12127 |

"AuvecoPak" AP448 RETAIL MERCHANDISER CONTENTS

NOTE: AuvecoPak part numbers are the same as standard Auveco part numbers with an "AP" prefix. Thus AP11146 is the AuvecoPak version of 11146.



Panel X1
Black Tapping Screws

- | | | | |
|---------|---------|---------|---------|
| AP12213 | AP12214 | AP12215 | AP12216 |
| AP12217 | AP12218 | AP12953 | AP12954 |
| AP12957 | AP11788 | AP11789 | AP11791 |
| AP11792 | AP15774 | AP13026 | AP17650 |
| AP12820 | AP12060 | AP18340 | AP17459 |
| AP20259 | AP20455 | AP16323 | AP10165 |
| AP10167 | AP10181 | AP10182 | AP11922 |
| AP12741 | AP12742 | AP15775 | AP15373 |



Panel X2
License Plate Screws, Body Bolts & Zinc/Chrome Tapping Screws

- | | | | |
|---------|---------|---------|---------|
| AP18354 | AP16421 | AP12351 | AP12339 |
| AP10823 | AP9480 | AP10362 | AP11320 |
| AP5711 | AP11109 | AP11110 | AP12324 |
| AP12693 | AP12067 | AP12160 | AP12065 |
| AP12066 | AP11633 | AP13613 | AP12348 |
| AP13614 | AP10642 | AP2805 | AP12095 |
| AP13708 | AP15172 | AP2806 | AP13027 |
| AP2710 | AP1799 | AP2713 | AP1483 |



Panel Y1
License Plate Screws, Zinc/Chrome Tapping Screws & Body Bolts, Bumper Bolts & Headlight Adjusting Screws

- | | | | |
|---------|---------|---------|---------|
| AP1717 | AP2730 | AP2775 | AP2771 |
| AP2751 | AP2772 | AP2773 | AP3466 |
| AP3467 | AP17098 | AP17980 | AP19777 |
| AP11369 | AP9603 | AP16960 | AP14473 |
| AP17315 | AP17316 | AP16826 | AP15170 |
| AP17034 | AP12335 | AP9615 | AP11914 |
| AP8443 | AP9355 | AP3099 | AP3102 |
| AP3178 | AP11655 | AP11826 | AP11243 |



Panel Y2
Moulding Clips Clips & Fasteners and Door Hinge Pins & Bushings

- | | | | |
|---------|---------|---------|---------|
| AP2744 | AP19626 | AP2619 | AP2752 |
| AP19807 | AP19378 | AP9965 | AP15695 |
| AP20687 | AP20390 | AP20391 | AP20688 |
| AP14642 | AP11152 | AP19800 | AP19757 |
| AP20607 | AP20774 | AP20328 | AP20377 |
| AP19822 | AP19821 | AP8941 | AP11067 |
| AP9633 | AP9639 | AP9749 | AP14559 |
| AP14550 | AP14553 | AP16936 | AP16937 |



Panel Z1
Extruded "U" Nuts, Cage Nuts, Spring Type "U" Nuts, Fender & Bumper Cover Nut and Retainer

- | | | | |
|---------|---------|---------|---------|
| AP10048 | AP15677 | AP8359 | AP10051 |
| AP10053 | AP8814 | AP10054 | AP10055 |
| AP11625 | AP11626 | AP16846 | AP12669 |
| AP16842 | AP16322 | AP12575 | AP11628 |
| AP11629 | AP11630 | AP11631 | AP14750 |
| AP5586 | AP5589 | AP5170 | AP20758 |
| AP10064 | AP10065 | AP9880 | AP20757 |
| AP9879 | AP10066 | AP15752 | AP10067 |



Panel Z2
"U" Nuts, Flat Nuts, Tubular Nuts, Cable Straps, Wire Loom Clips, Rubber Bumpers, Sheet Metal Plugs, Vacuum Caps, Shims & Miscellaneous

- | | | | |
|---------|---------|---------|---------|
| AP10666 | AP13225 | AP11292 | AP5197 |
| AP2293 | AP2099 | AP2103 | AP1903 |
| AP2611 | AP2595 | AP5195 | AP10073 |
| AP2288 | AP15518 | AP14298 | AP20380 |
| AP14546 | AP14547 | AP19440 | AP20397 |
| AP11746 | AP4233 | AP4188 | AP4474 |
| AP9288 | AP4440 | AP4439 | AP2453 |
| AP5076 | AP5077 | AP3155 | AP3156 |

**AP448 RETAIL MERCHANDISER CONTENTS
PART NUMBER LOCATION CHART**

Auveco Pak No.	Location			Auveco Pak No.	Location		
AP808	Panel T2	Row 7	Position 2	AP5753	Panel V2	Row 8	Position 1
AP1483	Panel X2	Row 8	Position 4	AP8301	Panel V2	Row 8	Position 3
AP1717	Panel Y1	Row 1	Position 1	AP8309	Panel V2	Row 7	Position 2
AP1799	Panel X2	Row 8	Position 2	AP8311	Panel V2	Row 8	Position 2
AP1903	Panel Z2	Row 2	Position 4	AP8313	Panel V2	Row 8	Position 4
AP2099	Panel Z2	Row 2	Position 2	AP8359	Panel Z1	Row 1	Position 3
AP2103	Panel Z2	Row 2	Position 3	AP8435	Panel W2	Row 1	Position 2
AP2288	Panel Z2	Row 4	Position 1	AP8443	Panel Y1	Row 7	Position 1
AP2293	Panel Z2	Row 2	Position 1	AP8814	Panel Z1	Row 2	Position 2
AP2309	Panel T2	Row 8	Position 1	AP8853	Panel U1	Row 6	Position 3
AP2310	Panel T2	Row 7	Position 4	AP8855	Panel W2	Row 4	Position 3
AP2453	Panel Z2	Row 7	Position 4	AP8863	Panel W2	Row 6	Position 2
AP2557	Panel W2	Row 6	Position 1	AP8864	Panel W2	Row 6	Position 3
AP2595	Panel Z2	Row 3	Position 2	AP8865	Panel W2	Row 6	Position 4
AP2611	Panel Z2	Row 3	Position 1	AP8868	Panel W2	Row 7	Position 1
AP2619	Panel Y2	Row 1	Position 3	AP8869	Panel W2	Row 7	Position 2
AP2710	Panel X2	Row 8	Position 1	AP8925	Panel V2	Row 7	Position 3
AP2713	Panel X2	Row 8	Position 3	AP8931	Panel V2	Row 7	Position 4
AP2730	Panel Y1	Row 1	Position 2	AP8941	Panel Y2	Row 6	Position 3
AP2744	Panel Y2	Row 1	Position 1	AP9288	Panel Z2	Row 7	Position 1
AP2751	Panel Y1	Row 2	Position 1	AP9297	Panel W2	Row 8	Position 2
AP2752	Panel Y2	Row 1	Position 4	AP9299	Panel W2	Row 8	Position 3
AP2771	Panel Y1	Row 1	Position 4	AP9355	Panel Y1	Row 7	Position 2
AP2772	Panel Y1	Row 2	Position 2	AP9480	Panel X2	Row 2	Position 2
AP2773	Panel Y1	Row 2	Position 3	AP9603	Panel Y1	Row 4	Position 2
AP2775	Panel Y1	Row 1	Position 3	AP9615	Panel Y1	Row 6	Position 3
AP2805	Panel X2	Row 6	Position 3	AP9633	Panel Y2	Row 7	Position 1
AP2806	Panel X2	Row 7	Position 3	AP9639	Panel Y2	Row 7	Position 2
AP2895	Panel W2	Row 4	Position 2	AP9749	Panel Y2	Row 7	Position 3
AP2896	Panel W2	Row 5	Position 1	AP9829	Panel W1	Row 6	Position 2
AP2897	Panel W2	Row 5	Position 2	AP9862	Panel W1	Row 7	Position 1
AP3099	Panel Y1	Row 7	Position 3	AP9879	Panel Z1	Row 8	Position 1
AP3102	Panel Y1	Row 7	Position 4	AP9880	Panel Z1	Row 7	Position 3
AP3155	Panel Z2	Row 8	Position 3	AP9965	Panel Y2	Row 2	Position 3
AP3156	Panel Z2	Row 8	Position 4	AP10048	Panel Z1	Row 1	Position 1
AP3178	Panel Y1	Row 8	Position 1	AP10051	Panel Z1	Row 1	Position 4
AP3403	Panel W2	Row 4	Position 1	AP10053	Panel Z1	Row 2	Position 1
AP3404	Panel W2	Row 4	Position 4	AP10054	Panel Z1	Row 2	Position 3
AP3405	Panel W2	Row 5	Position 3	AP10055	Panel Z1	Row 2	Position 4
AP3466	Panel Y1	Row 2	Position 4	AP10064	Panel Z1	Row 7	Position 1
AP3467	Panel Y1	Row 3	Position 1	AP10065	Panel Z1	Row 7	Position 2
AP3682	Panel W1	Row 8	Position 4	AP10066	Panel Z1	Row 8	Position 2
AP4188	Panel Z2	Row 6	Position 3	AP10067	Panel Z1	Row 8	Position 4
AP4233	Panel Z2	Row 6	Position 2	AP10073	Panel Z2	Row 3	Position 4
AP4439	Panel Z2	Row 7	Position 3	AP10086	Panel W2	Row 7	Position 4
AP4440	Panel Z2	Row 7	Position 2	AP10087	Panel W2	Row 8	Position 1
AP4474	Panel Z2	Row 6	Position 4	AP10165	Panel X1	Row 6	Position 4
AP5076	Panel Z2	Row 8	Position 1	AP10167	Panel X1	Row 7	Position 1
AP5077	Panel Z2	Row 8	Position 2	AP10181	Panel X1	Row 7	Position 2
AP5170	Panel Z1	Row 6	Position 3	AP10182	Panel X1	Row 7	Position 3
AP5195	Panel Z2	Row 3	Position 3	AP10330	Panel W1	Row 6	Position 3
AP5197	Panel Z2	Row 1	Position 4	AP10362	Panel X2	Row 2	Position 3
AP5586	Panel Z1	Row 6	Position 1	AP10374	Panel W2	Row 7	Position 3
AP5589	Panel Z1	Row 6	Position 2	AP10621	Panel T2	Row 6	Position 3
AP5711	Panel X2	Row 3	Position 1	AP10642	Panel X2	Row 6	Position 2

Auveco Pak No.	Location			Auveco Pak No.	Location		
AP10666	Panel Z2	Row 1	Position 1	AP12134	Panel T2	Row 8	Position 2
AP10733	Panel W2	Row 5	Position 4	AP12137	Panel T1	Row 7	Position 2
AP10744	Panel U1	Row 6	Position 2	AP12160	Panel X2	Row 4	Position 3
AP10823	Panel X2	Row 2	Position 1	AP12213	Panel X1	Row 1	Position 1
AP10831	Panel T1	Row 1	Position 2	AP12214	Panel X1	Row 1	Position 2
AP10832	Panel T1	Row 1	Position 1	AP12215	Panel X1	Row 1	Position 3
AP11067	Panel Y2	Row 6	Position 4	AP12216	Panel X1	Row 1	Position 4
AP11109	Panel X2	Row 3	Position 2	AP12217	Panel X1	Row 2	Position 1
AP11110	Panel X2	Row 3	Position 3	AP12218	Panel X1	Row 2	Position 2
AP11120	Panel T1	Row 2	Position 2	AP12255	Panel W2	Row 3	Position 3
AP11130	Panel T2	Row 1	Position 4	AP12324	Panel X2	Row 3	Position 4
AP11146	Panel T1	Row 1	Position 3	AP12335	Panel Y1	Row 6	Position 2
AP11152	Panel Y2	Row 4	Position 2	AP12339	Panel X2	Row 1	Position 4
AP11243	Panel Y1	Row 8	Position 4	AP12348	Panel X2	Row 5	Position 4
AP11292	Panel Z2	Row 1	Position 3	AP12351	Panel X2	Row 1	Position 3
AP11320	Panel X2	Row 2	Position 4	AP12565	Panel T2	Row 2	Position 2
AP11351	Panel T1	Row 6	Position 4	AP12567	Panel U2	Row 1	Position 1
AP11369	Panel Y1	Row 4	Position 1	AP12571	Panel T1	Row 8	Position 1
AP11612	Panel T1	Row 3	Position 1	AP12575	Panel Z1	Row 4	Position 3
AP11620	Panel W1	Row 1	Position 1	AP12595	Panel W1	Row 5	Position 2
AP11621	Panel W1	Row 1	Position 2	AP12652	Panel V2	Row 6	Position 4
AP11625	Panel Z1	Row 3	Position 1	AP12653	Panel W1	Row 1	Position 4
AP11626	Panel Z1	Row 3	Position 2	AP12655	Panel W1	Row 1	Position 3
AP11628	Panel Z1	Row 4	Position 4	AP12669	Panel Z1	Row 3	Position 4
AP11629	Panel Z1	Row 5	Position 1	AP12693	Panel X2	Row 4	Position 1
AP11630	Panel Z1	Row 5	Position 2	AP12731	Panel T1	Row 4	Position 4
AP11631	Panel Z1	Row 5	Position 3	AP12737	Panel T2	Row 6	Position 4
AP11633	Panel X2	Row 5	Position 2	AP12741	Panel X1	Row 8	Position 1
AP11655	Panel Y1	Row 8	Position 2	AP12742	Panel X1	Row 8	Position 2
AP11671	Panel T2	Row 3	Position 1	AP12757	Panel U2	Row 1	Position 4
AP11672	Panel T2	Row 6	Position 1	AP12759	Panel T2	Row 1	Position 2
AP11678	Panel T2	Row 5	Position 4	AP12766	Panel T1	Row 5	Position 4
AP11679	Panel T1	Row 4	Position 1	AP12820	Panel X1	Row 5	Position 1
AP11691	Panel W1	Row 6	Position 4	AP12909	Panel T1	Row 8	Position 2
AP11699	Panel U1	Row 8	Position 1	AP12953	Panel X1	Row 2	Position 3
AP11705	Panel U1	Row 7	Position 4	AP12954	Panel X1	Row 2	Position 4
AP11706	Panel U1	Row 8	Position 3	AP12957	Panel X1	Row 3	Position 1
AP11719	Panel W2	Row 1	Position 1	AP12992	Panel T2	Row 3	Position 3
AP11721	Panel T1	Row 3	Position 2	AP13004	Panel W1	Row 3	Position 1
AP11746	Panel Z2	Row 6	Position 1	AP13007	Panel W1	Row 2	Position 2
AP11788	Panel X1	Row 3	Position 2	AP13008	Panel W1	Row 2	Position 4
AP11789	Panel X1	Row 3	Position 3	AP13009	Panel W1	Row 2	Position 3
AP11791	Panel X1	Row 3	Position 4	AP13010	Panel W1	Row 3	Position 2
AP11792	Panel X1	Row 4	Position 1	AP13014	Panel W1	Row 4	Position 1
AP11796	Panel T2	Row 7	Position 1	AP13016	Panel W1	Row 4	Position 2
AP11797	Panel T2	Row 4	Position 2	AP13017	Panel W1	Row 4	Position 3
AP11826	Panel Y1	Row 8	Position 3	AP13026	Panel X1	Row 4	Position 3
AP11855	Panel W1	Row 6	Position 1	AP13027	Panel X2	Row 7	Position 4
AP11863	Panel T2	Row 7	Position 3	AP13225	Panel Z2	Row 1	Position 2
AP11914	Panel Y1	Row 6	Position 4	AP13232	Panel W1	Row 4	Position 4
AP11922	Panel X1	Row 7	Position 4	AP13450	Panel W1	Row 7	Position 2
AP12060	Panel X1	Row 5	Position 2	AP13461	Panel T2	Row 6	Position 2
AP12065	Panel X2	Row 4	Position 4	AP13470	Panel T2	Row 2	Position 3
AP12066	Panel X2	Row 5	Position 1	AP13613	Panel X2	Row 5	Position 3
AP12067	Panel X2	Row 4	Position 2	AP13614	Panel X2	Row 6	Position 1
AP12095	Panel X2	Row 6	Position 4	AP13708	Panel X2	Row 7	Position 1
AP12127	Panel W2	Row 8	Position 4	AP13748	Panel V2	Row 1	Position 1

Auveco Pak No.	Location			Auveco Pak No.	Location		
AP13750	Panel V2	Row 2	Position 2	AP15373	Panel X1	Row 8	Position 4
AP13751	Panel V2	Row 2	Position 1	AP15456	Panel T2	Row 1	Position 3
AP13752	Panel V2	Row 2	Position 4	AP15457	Panel T2	Row 1	Position 1
AP13753	Panel V2	Row 3	Position 1	AP15461	Panel T2	Row 5	Position 3
AP13755	Panel V2	Row 1	Position 2	AP15479	Panel T1	Row 8	Position 3
AP13932	Panel W1	Row 8	Position 1	AP15480	Panel T1	Row 7	Position 4
AP13933	Panel W1	Row 7	Position 4	AP15481	Panel T1	Row 7	Position 3
AP13960	Panel W1	Row 7	Position 3	AP15518	Panel Z2	Row 4	Position 2
AP13993	Panel U2	Row 7	Position 4	AP15543	Panel T1	Row 6	Position 1
AP13994	Panel V1	Row 2	Position 1	AP15677	Panel Z1	Row 1	Position 2
AP13996	Panel U2	Row 7	Position 3	AP15695	Panel Y2	Row 2	Position 4
AP14010	Panel U2	Row 1	Position 3	AP15711	Panel W2	Row 3	Position 4
AP14011	Panel U2	Row 1	Position 2	AP15752	Panel Z1	Row 8	Position 3
AP14016	Panel U1	Row 6	Position 4	AP15774	Panel X1	Row 4	Position 2
AP14019	Panel V1	Row 2	Position 3	AP15775	Panel X1	Row 8	Position 3
AP14020	Panel V1	Row 2	Position 4	AP15970	Panel T2	Row 3	Position 2
AP14021	Panel T1	Row 2	Position 4	AP15998	Panel T1	Row 8	Position 4
AP14023	Panel V2	Row 1	Position 3	AP16000	Panel V1	Row 4	Position 2
AP14032	Panel T1	Row 5	Position 2	AP16251	Panel W1	Row 3	Position 4
AP14036	Panel T1	Row 5	Position 3	AP16253	Panel W1	Row 3	Position 3
AP14127	Panel V2	Row 6	Position 3	AP16322	Panel Z1	Row 4	Position 2
AP14163	Panel U1	Row 4	Position 4	AP16323	Panel X1	Row 6	Position 3
AP14260	Panel V1	Row 3	Position 4	AP16421	Panel X2	Row 1	Position 2
AP14267	Panel W2	Row 3	Position 1	AP16622	Panel U2	Row 7	Position 2
AP14274	Panel W1	Row 8	Position 2	AP16695	Panel T2	Row 5	Position 2
AP14291	Panel U1	Row 2	Position 2	AP16782	Panel U1	Row 7	Position 2
AP14298	Panel Z2	Row 4	Position 3	AP16784	Panel U1	Row 7	Position 3
AP14313	Panel W1	Row 8	Position 3	AP16818	Panel T1	Row 4	Position 3
AP14328	Panel U1	Row 6	Position 1	AP16826	Panel Y1	Row 5	Position 3
AP14355	Panel U1	Row 2	Position 1	AP16834	Panel V2	Row 4	Position 1
AP14356	Panel U1	Row 1	Position 2	AP16835	Panel V1	Row 7	Position 4
AP14473	Panel Y1	Row 4	Position 4	AP16842	Panel Z1	Row 4	Position 1
AP14546	Panel Z2	Row 5	Position 1	AP16846	Panel Z1	Row 3	Position 3
AP14547	Panel Z2	Row 5	Position 2	AP16858	Panel V1	Row 5	Position 2
AP14550	Panel Y2	Row 8	Position 1	AP16864	Panel V2	Row 5	Position 3
AP14553	Panel Y2	Row 8	Position 2	AP16936	Panel Y2	Row 8	Position 3
AP14559	Panel Y2	Row 7	Position 4	AP16937	Panel Y2	Row 8	Position 4
AP14642	Panel Y2	Row 4	Position 1	AP16960	Panel Y1	Row 4	Position 3
AP14695	Panel W2	Row 1	Position 3	AP17004	Panel U1	Row 4	Position 3
AP14696	Panel V1	Row 3	Position 2	AP17006	Panel V2	Row 4	Position 3
AP14697	Panel V1	Row 3	Position 3	AP17034	Panel Y1	Row 6	Position 1
AP14736	Panel U1	Row 2	Position 4	AP17057	Panel V1	Row 6	Position 4
AP14737	Panel U1	Row 3	Position 1	AP17075	Panel T2	Row 4	Position 4
AP14738	Panel U1	Row 4	Position 2	AP17098	Panel Y1	Row 3	Position 2
AP14750	Panel Z1	Row 5	Position 4	AP17101	Panel V2	Row 2	Position 3
AP14753	Panel V1	Row 6	Position 2	AP17103	Panel U2	Row 7	Position 1
AP14921	Panel T1	Row 2	Position 3	AP17121	Panel V2	Row 5	Position 4
AP14992	Panel V1	Row 6	Position 1	AP17143	Panel V1	Row 7	Position 3
AP14994	Panel V1	Row 8	Position 2	AP17144	Panel V1	Row 8	Position 3
AP14997	Panel V1	Row 5	Position 1	AP17162	Panel U1	Row 7	Position 1
AP15042	Panel V1	Row 3	Position 1	AP17216	Panel V1	Row 1	Position 4
AP15044	Panel V1	Row 2	Position 2	AP17222	Panel U2	Row 6	Position 3
AP15170	Panel Y1	Row 5	Position 4	AP17267	Panel V1	Row 4	Position 4
AP15172	Panel X2	Row 7	Position 2	AP17315	Panel Y1	Row 5	Position 1
AP15326	Panel W1	Row 5	Position 1	AP17316	Panel Y1	Row 5	Position 2
AP15335	Panel W1	Row 5	Position 3	AP17339	Panel U1	Row 5	Position 1
AP15367	Panel T1	Row 3	Position 3	AP17379	Panel V1	Row 4	Position 1

Auveco Pak No.	Location	Auveco Pak No.	Location
AP17410	Panel V2 Row 6 Position 1	AP19682	Panel T2 Row 8 Position 3
AP17439	Panel V1 Row 5 Position 4	AP19721	Panel W2 Row 2 Position 4
AP17459	Panel X1 Row 5 Position 4	AP19729	Panel U1 Row 1 Position 3
AP17472	Panel V1 Row 6 Position 3	AP19739	Panel V1 Row 7 Position 2
AP17612	Panel T1 Row 3 Position 4	AP19756	Panel W2 Row 2 Position 2
AP17615	Panel V2 Row 4 Position 2	AP19757	Panel Y2 Row 4 Position 4
AP17632	Panel V1 Row 4 Position 3	AP19777	Panel Y1 Row 3 Position 4
AP17639	Panel V2 Row 7 Position 1	AP19800	Panel Y2 Row 4 Position 3
AP17649	Panel T2 Row 2 Position 1	AP19801	Panel U2 Row 6 Position 1
AP17650	Panel X1 Row 4 Position 4	AP19807	Panel Y2 Row 2 Position 1
AP17664	Panel T1 Row 1 Position 4	AP19821	Panel Y2 Row 6 Position 2
AP17975	Panel U1 Row 3 Position 4	AP19822	Panel Y2 Row 6 Position 1
AP17980	Panel Y1 Row 3 Position 3	AP19837	Panel T1 Row 4 Position 2
AP18033	Panel U1 Row 5 Position 4	AP20192	Panel T1 Row 2 Position 1
AP18108	Panel V2 Row 1 Position 4	AP20247	Panel U2 Row 4 Position 2
AP18114	Panel T2 Row 8 Position 4	AP20248	Panel U1 Row 8 Position 2
AP18119	Panel V1 Row 8 Position 1	AP20259	Panel X1 Row 6 Position 1
AP18153	Panel W1 Row 5 Position 4	AP20316	Panel T1 Row 6 Position 3
AP18167	Panel W1 Row 2 Position 1	AP20327	Panel U2 Row 5 Position 3
AP18297	Panel U1 Row 2 Position 3	AP20328	Panel Y2 Row 5 Position 3
AP18301	Panel T1 Row 5 Position 1	AP20335	Panel U2 Row 2 Position 1
AP18340	Panel X1 Row 5 Position 3	AP20348	Panel V1 Row 5 Position 3
AP18353	Panel U1 Row 8 Position 4	AP20349	Panel U2 Row 2 Position 4
AP18354	Panel X2 Row 1 Position 1	AP20362	Panel T1 Row 7 Position 1
AP18461	Panel V2 Row 4 Position 4	AP20366	Panel T1 Row 6 Position 2
AP18842	Panel U1 Row 3 Position 3	AP20377	Panel Y2 Row 5 Position 4
AP18848	Panel T2 Row 2 Position 4	AP20380	Panel Z2 Row 4 Position 4
AP18873	Panel V1 Row 1 Position 1	AP20390	Panel Y2 Row 3 Position 2
AP18877	Panel U1 Row 5 Position 3	AP20391	Panel Y2 Row 3 Position 3
AP18888	Panel U2 Row 3 Position 4	AP20397	Panel Z2 Row 5 Position 4
AP18915	Panel T2 Row 4 Position 1	AP20440	Panel W2 Row 2 Position 3
AP18930	Panel T2 Row 4 Position 3	AP20455	Panel X1 Row 6 Position 2
AP19113	Panel U1 Row 3 Position 2	AP20458	Panel U2 Row 8 Position 2
AP19114	Panel U1 Row 1 Position 1	AP20543	Panel U1 Row 1 Position 4
AP19118	Panel U2 Row 3 Position 2	AP20564	Panel U2 Row 5 Position 4
AP19140	Panel V1 Row 7 Position 1	AP20607	Panel Y2 Row 5 Position 1
AP19171	Panel U1 Row 5 Position 2	AP20627	Panel V2 Row 3 Position 3
AP19194	Panel W2 Row 2 Position 1	AP20629	Panel V2 Row 5 Position 1
AP19233	Panel U2 Row 5 Position 1	AP20632	Panel V1 Row 1 Position 2
AP19239	Panel U2 Row 3 Position 1	AP20687	Panel Y2 Row 3 Position 1
AP19246	Panel U2 Row 5 Position 2	AP20688	Panel Y2 Row 3 Position 4
AP19270	Panel T2 Row 5 Position 1	AP20741	Panel V2 Row 6 Position 2
AP19274	Panel U2 Row 4 Position 1	AP20757	Panel Z1 Row 7 Position 4
AP19376	Panel V2 Row 5 Position 2	AP20758	Panel Z1 Row 6 Position 4
AP19378	Panel Y2 Row 2 Position 2	AP20774	Panel Y2 Row 5 Position 2
AP19386	Panel T2 Row 3 Position 4	AP20788	Panel V2 Row 3 Position 2
AP19422	Panel V1 Row 1 Position 3	AP20834	Panel V2 Row 3 Position 4
AP19440	Panel Z2 Row 5 Position 3	AP20869	Panel U2 Row 2 Position 2
AP19453	Panel U2 Row 4 Position 4	AP20888	Panel U2 Row 6 Position 4
AP19613	Panel V1 Row 8 Position 4	AP20889	Panel U2 Row 8 Position 4
AP19614	Panel W2 Row 3 Position 2	AP20908	Panel U2 Row 2 Position 3
AP19615	Panel U2 Row 8 Position 3	AP20931	Panel U2 Row 8 Position 1
AP19626	Panel Y2 Row 1 Position 2	AP20954	Panel W2 Row 1 Position 4
AP19639	Panel U2 Row 6 Position 2	AP20955	Panel U2 Row 3 Position 3
AP19655	Panel U1 Row 4 Position 1	AP20986	Panel U2 Row 4 Position 3

BODY HARDWARE MASTER ASSORTMENTS

(6000 & 6500 Series Fix-Kits are listed on pages 290-308.)

A Great Introduction to Prospective Accounts or an Exciting New Program to Increase Sales at Existing Customers

Free Cabinet
when you buy
4 different assortments

The Most Popular
Body Hardware &
Specialty Fasteners



Based on Auveco's very popular **DB-425 Display Boards**, we have developed 20 different large metal drawer assortments. These assortments contain 425 of the most popular domestic and foreign Body Hardware Clips and Fasteners. Each drawer is set up to accommodate the Auveco unit package quantity - **no more problems with refills.**

Part No. 6650BHM: Buy a combination of any four different 6600BHM series individual drawer assortments and you'll receive one **FREE 2-96** four drawer cabinet.

Body Hardware Master Assortments Based On DB-425 Display Boards



6601BHM

Small Retainers &
Retaining Clips
24 Varieties, 795 Pieces

Contains the following
Auveco part numbers:

10621, 11612, 11796, 12565,
12737, 12992, 13470, 14021,
14291, 14328, 14736, 14737,
15367, 15970, 17339, 18033,
18114, 18297, 18848, 18877,
19114, 19682, 19729 & 20543



6602BHM

Large Retainers
22 Varieties, 965 Pieces

Contains the following
Auveco part numbers:

10831, 12137, 12571, 12731,
12759, 12766, 12909, 14036,
14738, 15414, 15479, 15543,
15998, 16818, 17004, 17612,
17664, 17975, 19837, 20192,
20362 & 20366



6603BHM

Hood Insulation Retainers,
Trim Panel Fasteners &
Rubber Vacuum Caps
16 Varieties, 440 Pieces

Contains the following
Auveco part numbers:

4439, 4440, 11863, 11130,
12134, 12209, 12210, 12907,
12908, 14163, 15456, 19613,
19614, 19655, 20757 & 20758

BODY HARDWARE MASTER ASSORTMENTS

Assortments Based On DB-425 Display Boards



6604BHM

Push-Type Retainers
24 Varieties, 445 Pieces

Contains the following
Auveco part numbers:
14260, 14753, 14992, 14997,
16000, 16858, 17057, 17143,
17144, 17267, 17379, 17472,
17632, 18119, 18888, 19118,
19239, 19739, 20335, 20348,
20349, 20869, 20908 & 20955



6605BHM

Push-Type Retainers
24 Varieties, 492 Pieces

Contains the following
Auveco part numbers:
12757, 13993, 13996, 14010,
14019, 14020, 17216, 17222,
18873, 19233, 19246, 19274,
19422, 19453, 19615, 19639,
19801, 20247, 20327, 20564,
20632, 20889, 20931 & 20986



6606BHM

Push-Type Retainers, Nylon Rivets
& Specialty Rivets
24 Varieties, 680 Pieces

Contains the following
Auveco part numbers:
12567, 12652, 13748, 13750,
13751, 13753, 13755, 14011,
14023, 14127, 16834, 16864,
17006, 17121, 17410, 17615,
17639, 18108, 18167, 18353,
18461, 19376, 20629 & 20741



6607BHM

Specialty Rivets, Double End Drill
& Moulding Clips
24 Varieties, 925 Pieces

Contains the following
Auveco part numbers:
8301, 8311, 8313, 8925,
8931, 12653, 12655, 12658,
12676, 14642, 16837, 16838,
19757, 19821, 19822, 20328,
20377, 20523, 20607, 20626,
20627, 20774, 20788 & 20834



6608BHM

Moulding Clips & Fasteners,
Plug Buttons & Wire Loom Clips
22 Varieties, 840 Pieces

Contains the following
Auveco part numbers:
2619, 2744, 2752, 8941,
9288, 9633, 9749, 9965,
11746, 14545, 14546, 14547,
19378, 19626, 19807, 20390,
20391, 20392, 20397, 20429,
20687 & 20688



6609BHM

Phillips Oval Head,
Phillips Pan Head &
Specialty Tapping Screws
(Chrome & Zinc)
24 Varieties, 2,400 Pieces

Contains the following
Auveco part numbers:
1423, 1483, 1717, 1794, 1796,
1799, 1940, 1943, 2027, 2365,
2366, 2367, 2710, 2713, 2728,
2730, 2731, 3079, 3090, 9603,
9605, 12095, 15172 & 19777



6610BHM

Phillips Oval Hd. Sems (Chrome &
Black Phosphate) & Hex Washer
Head (Zinc and Zinc & Yellow)
Tapping Screws
24 Varieties, 1,825 Pieces

Contains the following
Auveco part numbers:
2751, 2772, 2773, 2775, 3466,
3467, 9611, 9615, 11369, 11450,
11451, 11455, 11456, 11788,
11789, 11790, 11791, 11792,
11914, 15170, 16828, 16960,
17098 & 17980



6611BHM

Phillips Oval Hd. (Black Oxide),
Phillips Pan Hd. (Black Oxide) &
Specialty Tapping Screws
(Black. E-Coat)
24 Varieties, 2,175 Pieces

Contains the following
Auveco part numbers:
10180, 10181, 10182, 11917,
11921, 11922, 11923, 12799,
10162, 10164, 10165, 10166,
10167, 10168, 11086, 11087,
11088, 11089, 12796, 12797,
12820, 12957, 16323 & 20259



6612BHM

Phillips Flat Top Washer Hd. (Black),
Hex Head Sems (Black) & Hex
Slotted Hd. (Black) Tapping Screws
23 Varieties, 1,750 Pieces

Contains the following
Auveco part numbers:
12060, 12213, 12214, 12215,
12216, 12217, 12218, 12339,
12351, 12738, 12742, 12953,
12954, 13026, 15373, 15774,
15775, 16421, 17459, 17650,
18340, 18354 & 20455

BODY HARDWARE MASTER ASSORTMENTS

Assortments Based On DB-425 Display Boards



6613BHM

Hex Head Sems & Hex Washer Hd.
Body Bolts (Black)
21 Varieties, 810 Pieces

Contains the following
Auveco part numbers:
9480, 10362, 10823, 11109,
11110, 11320, 11641, 12065,
12066, 12160, 12232, 12324,
12336, 12343, 12693, 13613,
13614, 13618, 13619, 18416
& 18769



6614BHM

Hex Head Sems & Hex Washer Hd.
Body Bolts (Zinc), Bumper Bolts
& Specialty Fasteners
12 Varieties, 445 Pieces

Contains the following
Auveco part numbers:
4474, 5242, 5246, 8443,
11295, 12335, 14473, 14976,
16826, 17316, 18262 & 19339



6615BHM

Spin Lock Nuts, Hex Flange Nuts,
Free Spinning Washer Nuts,
Jack Nuts & Well Nuts
23 Varieties, 705 Pieces

Contains the following
Auveco part numbers:
11644, 11645, 12595, 12596,
12995, 12999, 13004, 13007,
13008, 13009, 13010, 13014,
13016, 14855, 15326, 15329,
15334, 15335, 16470, 16769,
16830, 16883 & 20415



6616BHM

"J" Nuts, Spring Type "U" Nuts
& Extruded "U" Nuts
23 Varieties, 965 Pieces

Contains the following
Auveco part numbers:
5586, 5589, 8359, 8814, 9879,
9880, 10051, 10053, 10054,
10055, 10064, 10065, 10066,
10067, 11628, 11629, 11630,
11631, 12575, 12669, 14750,
15677 & 15752



6617BHM

Flat Nuts, "U" Nuts, Tubular
Nuts & Shims
11 Varieties, 950 Pieces

Contains the following
Auveco part numbers:
1903, 2089, 2099, 2293,
2595, 3155, 3156, 5076,
5077, 5196 & 11292



6618BHM

Washer Lock Nuts,
Thread Cutting Nuts,
Push-On Retainers &
Pushnut Bolt Retainers
23 Varieties, 2,300 Pieces

Contains the following
Auveco part numbers:
2555, 2557, 2896, 2897, 3404,
3405, 8863, 8864, 8865, 8868,
8869, 9297, 9299, 10086, 10087,
10374, 10733, 12123, 12127,
12253, 12255, 12259 & 14980



6619BHM

Nylon Nuts & Screw Grommets
23 Varieties, 860 Pieces

Contains the following
Auveco part numbers:
3682, 8435, 9829, 9862,
11368, 11691, 11719, 13450,
13932, 13933, 13960, 14031,
14267, 14268, 14274, 14275,
14695, 18153, 19194, 19721,
19756, 20440 & 20954



6620BHM

Door Hinge Pins & Bushings,
Headlight Hardware,
Door Lock Rod Clips,
Window Crank Handle Ret. Clips
& Cable Straps
14 Varieties, 336 Pieces

Contains the following
Auveco part numbers:
2288, 3178, 11243, 14298, 14550, 14553, 14559,
15518, 15940, 16936, 16937, 19424, 19781 & 20380

ADDITIONAL BODY HARDWARE MASTER ASSORTMENTS



6636BHM

Small Size
Grade 5 USS
Cap Screws,
Nuts & Washers
14 Varieties, 1,650 Pieces

Auveco Part No.	Size
5434	1/4"-20 x 1/2"
5436	1/4"-20 x 3/4"
5438	1/4"-20 x 1"
5449	5/16"-18 x 3/4"
5451	5/16"-18 x 1"
5452	5/16"-18 x 1-1/4"
5453	5/16"-18 x 1-1/2"
5455	5/16"-18 x 2"
5463	3/8"-16 x 3/4"
5465	3/8"-16 x 1"
5466	3/8"-16 x 1-1/4"
5467	3/8"-16 x 1-1/2"
5469	3/8"-16 x 2"
5471	3/8"-16 x 2-1/2"
15586	1/4"-20 Hex Nut
15587	5/16"-18 Hex Nut
15588	3/8"-16 Hex Nut
8606	1/4" USS Washer
8607	5/16" USS Washer
8608	3/8" USS Washer



6634BHM

Large Size
Metric Cap Screws,
Nuts & Washers
12 Varieties, 380 Pieces

Auveco Part No.	Size
14430	M10-1.5 x 20mm
14431	M10-1.5 x 25mm
14432	M10-1.5 x 30mm
14433	M10-1.5 x 35mm
14434	M10-1.5 x 40mm
14436	M10-1.5 x 50mm
14438	M10-1.5 x 60mm
14439	M10-1.5 x 70mm
14441	M12-1.75 x 30mm
14442	M12-1.75 x 35mm
14443	M12-1.75 x 40mm
14445	M12-1.75 x 50mm
14454	M10-1.5 Hex Nut
14455	M12-1.75 Hex Nut
17395	10mm Flat Washer
10583	12mm Flat Washer



6642BHM

Large Size
Grade 5 USS
Cap Screws,
Nuts & Washers
8 Varieties, 650 Pieces

Auveco Part No.	Size
5463	3/8"-16 x 3/4
5465	3/8"-16 x 1"
5466	3/8"-16 x 1-1/4"
5467	3/8"-16 x 1-1/2"
5469	3/8"-16 x 2"
5471	3/8"-16 x 2-1/2"
5476	7/16"-14 x 1"
5477	7/16"-14 x 1-1/4"
15588	3/8"-16 Hex Nut
15589	7/16"-14 Hex Nut
8608	3/8" USS Washer
8609	7/16" USS Washer



6629BHM

J.I.S. Hex Flange Bolts
& Spin Lock Nuts
21 Varieties, 550 Pieces

Auveco Part No.	Size
17315	M6-1.0 x 12mm
17316	M6-1.0 x 16mm
18807	M6-1.0 x 20mm
21048	M6-1.0 x 25mm
18808	M6-1.0 x 30mm
18809	M6-1.0 x 40mm
18980	M8-1.25 x 12mm
17387	M8-1.25 x 16mm
17388	M8-1.25 x 20mm
21051	M8-1.25 x 25mm
17389	M8-1.25 x 30mm
21052	M8-1.25 x 35mm
17390	M8-1.25 x 40mm
21053	M8-1.25 x 45mm
17188	M10-1.25 x 16mm
17189	M10-1.25 x 20mm
21054	M10-1.25 x 25mm
17190	M10-1.25 x 30mm
21055	M10-1.25 x 35mm
17191	M10-1.25 x 40mm
21056	M10-1.25 x 45mm
16769	M6-1.0 Nut
16830	M8-1.25 Nut
16470	M10-1.25 Nut



6635BHM

Small Size
Metric Cap Screws,
Nuts & Washers
14 Varieties, 925 Pieces

Auveco Part No.	Size
14403	M5-.8 x 16mm
14404	M5-.8 x 20mm
14407	M6-1.0 x 12mm
14408	M6-1.0 x 16mm
14409	M6-1.0 x 20mm
14410	M6-1.0 x 25mm
14411	M6-1.0 x 30mm
14419	M8-1.25 x 16mm
14420	M8-1.25 x 20mm
14421	M8-1.25 x 25mm
14422	M8-1.25 x 30mm
14423	M8-1.25 x 35mm
14424	M8-1.25 x 40mm
14426	M8-1.25 x 50mm
14449	M5-.8 Hex Nut
14450	M6-1.0 Hex Nut
14452	M8-1.25 Hex Nut
10578	5mm Flat Washer
17393	6mm Flat Washer
17394	8mm Flat Washer

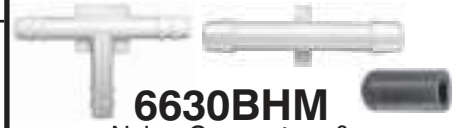

6630BHM

Nylon Connectors &
Rubber Vacuum Caps
24 Varieties, 310 Pieces

Auveco Part No.	Size
Nylon Connectors	
12929	1/8" x 1/8" Straight
12930	1/8" x 3/16" Straight
12936	1/8" x 1/4" Straight
12937	3/16" x 3/16" Straight
12935	1/4" x 3/16" Straight
12931	1/4" x 1/4" Straight
12946	5/16" x 5/16" Straight
12923	1/8" x 1/8" x 1/8" Tee
12926	3/16" x 3/16" x 1/8" Tee
12918	3/16" x 3/16" x 3/16" Tee
12919	1/4" x 3/16" x 3/16" Tee
11738	1/4" x 1/4" x 3/16" Tee
17629	1/4" x 1/4" x 1/4" Tee
12920	5/16" x 5/16" x 5/16" Tee
12927	3/16" x 3/16" x 3/16" "Y"
12943	1/4" x 1/4" x 1/4" "Y"
12932	3/16" x 3/16" Elbow
12939	3/16" Cross
Rubber Caps	
12209	For 1/8" O. D. Tube
4440	For 3/16" O. D. Tube
4439	For 1/4" O. D. Tube
12907	For 5/16" O. D. Tube
12210	For 3/8" O. D. Tube
12908	For 1/2" O. D. Tube

Sec. 15

ADDITIONAL BODY HARDWARE MASTER ASSORTMENTS



6631BHM

Krimp and Seal
Terminals & Connectors
24 Varieties, 240 Pieces

Auveco
Part No. Description

- 13656 Ring Type, 22-18 Ga.
- 13657 Ring Type, 22-18 Ga.
- 13658 Spade Type, 22-18 Ga.
- 13659 Butt Conn., 22-18 Ga.
- 13660 Female Q. C., 22-18 Ga.
- 13661 Male Q. C., 22-18 Ga.
- 13662 Ring Type, 16-14 Ga.
- 13663 Ring Type, 16-14 Ga.
- 13664 Ring Type, 16-14 Ga.
- 13665 Ring Type, 16-14 Ga.
- 13666 Ring Type, 16-14 Ga.
- 13669 Butt Conn., 16-14 Ga.
- 13670 Female Q. C., 16-14 Ga.
- 13671 Male Q. C., 16-14 Ga.
- 13672 Female Q. C., 16-14 Ga.
- 13673 Male Q. C., 16-14 Ga.
- 13681 Female Plug, 16-14 Ga.
- 13682 Male Plug, 16-14 Ga.
- 13674 Ring Type, 12-10 Ga.
- 13675 Ring Type, 12-10 Ga.
- 13676 Ring Type, 12-10 Ga.
- 13678 Butt Conn., 12-10 Ga.
- 13679 Female Q. C., 12-10 Ga.
- 13680 Male Q. C., 12-10 Ga.



6643BHM

High Performance
Imported Miniature Bulbs
24 Varieties, 240 Pieces

Contain the following
Auveco Part Numbers:
B24, B24A, B53, B57, B67, B67A, B68, B89, B97, B168, B194, B194A, B906, B906A, B912, B916, B916A, B921, B921A, B1141, B1156, B1156A, B1157 & B1157A



6644BHM

High Performance
Imported Miniature Bulbs
23 Varieties, 230 Pieces

Contain the following
Auveco Part Numbers:
B1893, B1895, B2057, B2057A, B2357, B2357A, B3057, B3057A, B3156, B3156A, B3157, B3157A, B3357, B3357A, B3457, B3457A, B4114K, B4157, B4157K, B7440, B7440A, B7443 & B7443A



6645BHM

High Performance
Imported Halogen Bulbs
24 Varieties, 24 Pieces

Contain the following
Auveco Part Numbers:
B880, B881, B884, B885, B886, B889, B890, B891, B893, B894, B896, B899, B9004, B9005, B9006, B9007, BH1, BH3, BH7, BH9, BH10, BH11, BH13 & BD2C



6699BHM

High Performance
Imported Miniature & Halogen Bulbs
71 Varieties, 494 Pieces

Contains Auveco Assortments
6643BHM, 6644BHM, 6645BHM, 1-924 24 Compartment Empty Drawer and 2-96 Four Drawer Cabinet.



6641BHM

Cable Ties & Straps
10 Varieties, 575 Pieces

Auveco
Part No. Description

- 8550 2-1/4" Long, 7/16" Wide
- 14298 148mm Long, 8mm Wide
- 15144 4" Long, 3/32" Wide
- 15145 5-1/2" Long, 1/8" Wide
- 15146 7" Long, 3/16" Wide
- 15147 11" Long, 3/16" Wide
- 15148 14" Long, 5/16" Wide
- 15753 14" Long, 3/16" Wide
- 20380 200mm Long, 5mm Wide
- 21203 155mm Long, 5mm Wide



6628BHM

Oil Drain Plugs & Gaskets
24 Varieties, 105 Pieces

Auveco
Part No. Size

- 14196 1/2"-20
- 18373 1/2"-20
- 19130 1/2"-20
- 19365 1/2"-20, Magnetic
- 15527 M12-1.25
- 19588 M12-1.25
- 14677 M12-1.75
- 18023 M12-1.75
- 18374 M12-1.75
- 20347 M12-1.75
- 21047 M12-1.75
- 18024 M14-1.25
- 14678 M14-1.5
- 16308 M14-1.5
- 18025 M14-1.5
- 18375 M14-1.5
- 19141 M14-1.5
- 19279 M14-1.5
- 19620 M14-1.5 Single Oversize
- 19773 M14-1.5
- 20426 M14-1.5
- 15528 M16.4-1.33
- 15529 M18-1.5
- 15530 M20-1.5



6637BHM

Nylon Rivets

16 Varieties, 475 Pieces

Auveco Part No.	Size	
20754	6mm	Grip: 2.5mm-4.8mm
13746	3/16"	Grip: 1/16"-9/64"
13747	13/64"	Grip: 1/16"-11/64"
13748	13/64"	Grip: 1/8"-15/64"
13755	13/64"	Grip: 15/64"-25/64"
14004	15/64"	Grip: 11/64"-11/32"
13752	17/64"	Grip: 3/32"-3/16"
13753	17/64"	Grip: 3/32"-3/16"
18502	1/4"	Grip: 5/32"-1/4"
13750	1/4"	Grip: 5/32"-13/32"
17101	1/4"	Grip: 5/16"-15/32"
18108	1/4"	Grip: 5/32"-3/8"
21028	1/4"	Grip: 5/32"-3/8"
13751	1/4"	Grip: 5/32"-13/32"
15490	9/32"	Grip: 3/32"-15/64"
14023	15/64"	Grip: 5/32"-5/16"



6633BHM

Metal Specialty Rivets
24 Varieties, 850 Pieces

Auveco Part No.	Size	
1/8" (3.2mm) Diameter		
20788		Grip: 3/64" - 1/8"
20627		Grip: 3/64" - 3/16"
16834		Grip: 1/8" - 3/16"
8931		Grip: 3/16" - 1/4"
17615		Grip: 3/16" - 3/8"
5/32" (4mm) Diameter		
18461		Grip: 3/64" - 1/4"
20629		Grip: 3/64" - 1/4"
20971		Grip: 3/64" - 9/32"
19376		Grip: 1/8" - 11/32"
17006		Grip: 1/4" - 3/8"
3/16" (4.8mm) Diameter		
16864		Grip: 3/64" - 11/32"
20741		Grip: 3/64" - 23/64"
17121		Grip: 5/64" - 15/64"
8311		Grip: 1/8" - 1/4"
17410		Grip: 3/8" - 1/2"
14127		Grip: 3/8" - 1/2"
1/4" (6.4mm) Diameter		
16837		Grip: 1/32" - 9/64"
12653		Grip: 3/32" - 1/8"
18167		Grip: 3/32" - 9/64"
12652		Grip: 1/8" - 1/4"
12655		Grip: 9/64" - 3/16"
17639		Grip: 3/16" - 3/8"
8313		Grip: 1/4" - 3/8"
16838		Grip: 33/64" - 19/32"



6638BHM

GM Moulding Clips
24 Varieties, 415 Pieces

Contains the following Auveco part numbers:

- 10617, 14642, 19757, 19800, 19820, 19821, 19822, 20280, 20318, 20328, 20353, 20377, 20607, 20756, 20774, 20808, 20865, 20884, 20934, 20952, 20972, 20976, 21128 & 21374



6632BHM

GM, Ford & Chrysler Push-Type Retainers
12 Varieties, 400 Pieces

Contains the following Auveco part numbers:

- 17216, 20889, 20888, 20991, 20826, 20992, 20880, 20988, 20989, 20990, 20993 & 20994



6622BHM

BMW Clips & Fasteners
14 Varieties, 565 Pieces

Auveco Part No.	Description
13158	Moulding Clip
13162	"U" Nut
13215	"U" Nut
13216	"U" Nut
13218	"U" Nut
13223	"U" Nut
18156	M4.8-1.59 x 16mm L.P. Screw
20186	Grommet
20234	Push-Type Retainer
20248	Push-Type Retainer
20253	Trim Panel Retainer
20270	Push-Type Retainer
20734	Push-Type Retainer
20754	Nylon Rivet



6624BHM

Honda & Acura Push-Type Retainers
24 Varieties, 360 Pieces

Contains the following Auveco part numbers:

- 14696, 14697, 16000, 16782, 17057, 17143, 17144, 17267, 17379, 18119, 19118, 19140, 19231, 19233, 19239, 19416, 19453, 20247, 20352, 20564, 20608, 20986, 21173 & 21297



6623BHM

Honda & Acura Retainers & Retaining Clips
24 Varieties, 595 Pieces

Contains the following Auveco part numbers:

- 14289, 14291, 14328, 15998, 16775, 16776, 16779, 17205, 18114, 18294, 18746, 18877, 19114, 19116, 19145, 19171, 19470, 19506, 19682, 20334, 20609, 20610, 20882 & 21107



6639BHM

Hyundai & Kia Clips & Fasteners
20 Varieties, 455 Pieces

Auveco Part No.	Description
20543	Hood Ins. Retainer
20566	Moulding Clip
20567	Moulding Clip
20568	Moulding Clip
20680	L. P. Screw
21064	Moulding Clip
21067	Bumper & Grille Retainer
21068	Nylon Nut
21070	Trim Panel Retainer
21136	Moulding Clip
21146	Push-Type Retainer
21188	Trim Panel Retainer
21244	Moulding Clip
21312	Moulding Clip
21321	Moulding Clip
21328	Push-Type Retainer
21360	Trim Panel Retainer
21378	Nylon "U" Nut
21381	Hood Seal Retainer
21382	Cowl & Grille Retainer

Sec. 15

ADDITIONAL BODY HARDWARE MASTER ASSORTMENTS



6621BHM

Mercedes-Benz
Clips & Fasteners

24 Varieties, 665 Pieces

Auveco

Part No. Description

13215	"U" Nut
13216	"U" Nut
13218	"U" Nut
13220	"U" Nut
13223	"U" Nut
13224	"U" Nut
13230	Push-Type Retainer
16124	Tubular Type Nut
20187	Push-Type Retainer
20188	Trim Panel Retainer
20203	Push-Type Retainer
20205	Moulding Insert
20314	Push-Type Retainer
20636	Push-Type Retainer
20637	Push-Type Retainer
20638	Push-Type Retainer
20642	Door Panel Ret. Clip
20645	Carpet Retainer
20650	"U" Nut
20735	Door Panel Retainer
20897	Moulding Clip
20909	Push-Type Retainer
20971	Rivet
21105	Hood Ins. Retainer



6625BHM

Nissan & Infiniti

Retainers & Push-Type Retainers
24 Varieties, 525 Pieces

Contains the following

Auveco part numbers:

14355, 14696, 14737, 16000,
16776, 16782, 16784, 16858,
16859, 17237, 17347, 17452,
17472, 18166, 18948, 19246,
19274, 19684, 20327, 20348,
20349, 20672, 20953 & 21192



6626BHM

Toyota & Lexus

Retainers & Retaining Clips
24 Varieties, 550 Pieces

Contains the following

Auveco part numbers:

14269, 14736, 14737, 14738,
15709, 18297, 18692, 18842,
18844, 18876, 18878, 19112,
19113, 19210, 19257, 19729,
19749, 19842, 20437, 20443,
20633, 20757, 20758 & 21102



6646BHM

Subaru

Clips & Fasteners

24 Varieties, 450 Pieces

Auveco

Part No. Description

21322	Panel Retainer
21420	Push-Type Retainer
21421	Hood Ins. Retainer
21422	Push-Type Retainer
21500	Push-Type Retainer
21501	Push-Type Retainer
21502	Panel Retainer
21530	Push-Type Retainer
21531	Cowl Panel Vent Cap
21563	Push-Type Retainer
21566	Push-Type Retainer
21570	Push-Type Retainer
21571	Push-Type Retainer
21572	Grille Clip
21574	Trim Retainer
21576	Push-Type Retainer
21580	Push-Type Retainer
21581	Moulding Clip
21584	Panel Retainer
21585	Push-Type Retainer
21591	Moulding Clip
21592	Push-Type Retainer
21593	Push-Type Retainer
21594	Push-Type Retainer



6640BHM

Volkswagen & Audi
Clips & Fasteners

24 Varieties, 595 Pieces

Auveco

Part No. Description

13173	Door Panel Clip
13475	Trim Panel Retainer
17006	Moulding Rivet
19195	Push-Type Retainer
20341	Trim Panel Retainer
20924	Screw Grommet
20925	Screw Grommet
21144	Trim Panel Retainer
21145	Hood Ins. Retainer
21251	Push-Type Retainer
21392	Cowl & Grille Retainer
21393	Trim Retainer
21394	Moulding Clip
21395	Moulding Clip
21396	Moulding Clip
21397	Moulding Clip Grommet
21398	Trim Panel Retainer
21399	Screw Grommet
21449	Moulding Clip
21478	Moulding Clip
21479	Push-Type Retainer
21512	Moulding Clip
21513	Push-On Retainer
21515	Fender & Bumper Retainer



6627BHM

Toyota & Lexus

Push-Type Retainers
24 Varieties, 316 Pieces

Contains the following

Auveco part numbers:

14260, 16784, 17162, 17439,
18270, 18873, 18888, 19140,
19416, 19552, 19739, 20335,
20349, 20577, 20869, 20908,
20931, 20955, 21010, 21011,
21103, 21123, 21201 & 21294

You Can E-mail
Your Suggestions
For New Assortments
To mail@auveco.com
We Welcome All
Your Suggestions

SMALL EMPTY DRAWERS AND CABINETS



Cabinet and drawers with plastic inserts are sturdily built of heavy gauge steel. The Kits are designed with scoop compartments and slide easily on the cabinet slide. All items are available in Unit Packages. For refills, order by Auveco number on lid label.

- 6-60 Cabinet & 6 Empty Small Drawers**
(24 Compartment Drawers With Locking Latches)
15-1/4" W x 11-3/4" D x 16-3/8" H
Finish: Light Green Enamel
Drawer Size: 13-5/16" Wide x 9-1/4" Deep x 2" High

- 3-60 Empty Cabinet.** Holds 6 Small Drawers

- 4-60 Empty Cabinet.** Will Hold 4 Small Drawers.
15-1/4" Wide x 11-3/4" Deep x 11-1/4" High
Finish: Light Green Enamel
Drawer Size: Same as the 6-60



Empty Drawers (13-5/16" Wide x 9-1/4" Deep x 2" High) Are Available
In 8, 12, 16, 20, 21 And 24 Compartment Layouts:

- 2-608** 8 Compartment Empty Drawer With Locking Latch
- 2-612** 12 Compartment Empty Drawer With Locking Latch
- 2-616** 16 Compartment Empty Drawer With Locking Latch
- 2-620** 20 Compartment Empty Drawer With Locking Latch
- 2-621** 21 Compartment Empty Drawer With Locking Latch
- 2-624** 24 Compartment Empty Drawer With Locking Latch

LARGE EMPTY DRAWERS AND CABINETS



4-96 Cabinet & 4 Empty Large Drawers
 (24 Compartment Drawers With Locking Latches).
 20" Wide x 15-3/4" Deep x 14-1/2" High
 Finish: Light Green Enamel
 Drawer Size: 18" Wide x 12" Deep x 3" High

2-96 Empty Cabinet. Will Hold 4 Large Drawers



3-96 Empty Cabinet. Will Hold 2 Large Drawers.
 20" Wide x 15-3/4" Deep x 8" High
 Finish: Light Green Enamel
 Drawer Size: Same As 4-96

Base B-3 for cabinets 2-96, 3-96 and 4-96 is pictured on page 298



No. 1-902



No. 1-901



No. 1-924



No. 1-901 DIVIDERS



No. 1-900

Empty Drawers With Locking Latches (18" Wide x 12" Deep x 3" High) Are Available In 12, 16, 20, 24, and 32 Compartment Layouts:

- 1-900** Adjustable Compartment Empty Drawer with 3 Vertical & 3 Horizontal Dividers
- 1-901** Adjustable Compartment Empty Drawer with 9 dividers.
- 1-901 DIVIDERS** 2-15/16" x 4-5/16" Divider for 1-901 Drawer

- 1-902** Adjustable Compartment Empty Drawer with 6 fixed horizontal compartments and 12 movable dividers adjustable on 1" centers.
- 1-912** 12 Compartment Empty Drawer
- 1-916** 16 Compartment Empty Drawer
- 1-920** 20 Compartment Empty Drawer
- 1-924** 24 Compartment Empty Drawer
- 1-932** 32 Compartment Empty Drawer

“FIX-KIT”® LID LABELS & CABINETS

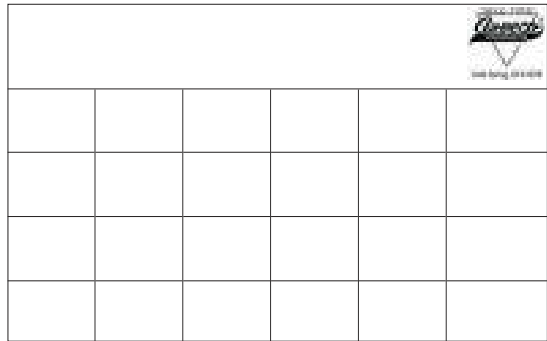

Printed lid labels in 12, 16, 20 and 24 compartment layouts (small and large drawer sizes). Same size and layout as Fix-Kit® lid labels. Labels have a peel-away liner and self-adhesive backing for permanent adhesion.

Large Drawer Lid Labels

1-900L
Assortment of 1 each of 1-912L, 1-916L, 1-920L & 1-924L.
UNIT PKG: 1 Set

1-912L
Large Drawer
12 Compartment
Lid Label
UNIT PKG: 5

1-916L
Large Drawer
16 Compartment
Lid Label
UNIT PKG: 5

1-920L
Large Drawer
20 Compartment
Lid Label
UNIT PKG: 5

1-924L
Large Drawer
24 Compartment
Lid Label
UNIT PKG: 5

Small Drawer Lid Labels

2-600L
Assortment of 1 each of 2-612L, 2-616L, 2-620L & 2-624L
UNIT PKG: 1 Set

2-612L
Small Drawer
12 Compartment
Lid Label
UNIT PKG: 5

2-616L
Small Drawer
16 Compartment
Lid Label
UNIT PKG: 5

2-620L
Small Drawer
20 Compartment
Lid Label
UNIT PKG: 5

2-624L
Small Drawer
24 Compartment
Lid Label
UNIT PKG: 5



**No. 1-MBC
Miniature Bulb Cabinet**

19" Wide x 4" Deep x 26-3/4" High
Ideal for the storage and organization of automotive miniature bulbs, fuses, etc. Features 4 durable plastic tilt-out trays with 28 adjustable dividers allowing for the creation of from 4 to 32 compartments. Back-up storage shelves are located behind the hinged cover. Can be hung on wall using keyholes punched in the back. Constructed of prime cold rolled steel with gray powder coat finish.

Can be shipped via UPS



**No. 1-HTWD
Hose, Tubing and Wire Dispenser**

19-9/16" Wide x 7-1/2" Deep x 11-15/16" (front), 13-3/32" High (back)
Holds up to 6 reels of hose, tubing or wire with 1" diameter grommets in the front that assure smooth, tangle free dispensing. Can be hung on wall using keyholes punched in the back. Constructed of prime cold rolled steel with gray powder coat finish.

Can be shipped via UPS

CABINETS AND RACKS



No. 1-WSR

Wire Spool Rack

26-1/8" Wide x 6" Deep x 37-1/8" High
Four sturdy steel rods provide secure and convenient storage for reels as large as 11" in diameter. Heavy duty steel with enamel finish. Does not include wire.
Weight: 20 lbs.

Can be shipped UPS

No. 2-WSR

Wire Spool Rack

26" Wide x 5-3/4" Deep x 18" High
Two sturdy steel rods for storing and dispensing spools of wire. May be counter, wall or vehicle mounted.
Shipping Weight 15 lbs. per carton

Can be shipped via UPS



No. 1-TR

Threaded Rod Rack

24" Wide x 6-7/8" Deep x 24-3/8" High
Separates and protects threaded rods, in 18 separate compartments, 2-1/8" (54.0mm) in diameter. Does not include threaded rod stock.
Heavy duty steel with enamel finish
Weight: 14 lbs.

Can be shipped UPS

RACKS



No. 1-KS

Key Stock Rack

12-1/4" Wide x 6-1/8" Deep x 12" High
Designed to hold material used in the manufacture of keyways which generally run from 1/8" square up to 3/4" square and approximately 12" long. Offers a total of 12 compartments for the convenient storage of stock of 12 different sizes. A 3" panel is furnished for both wall protection or use as a sign. Keyhole slots permit wall mounting. Does not include key stock. Heavy duty steel with enamel finish.
Weight: 7 lbs.

Can be shipped UPS

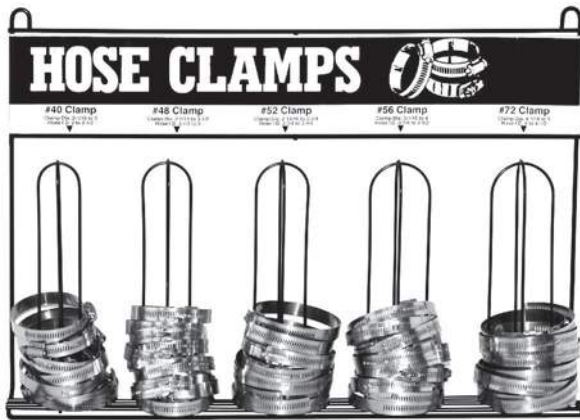

No. 5-HCR

5 Loop Hose Clamp Rack

23-1/4" Wide x 5-3/8" Deep x 16-1/8" High
Holds 5 sizes of clamp diameters: #40 (2-1/16" to 3"), #48 (2-9/16" to 3-1/2"), #52 (2-13/16" to 3-3/4"), #56 (3-1/16" to 4") and #72 (4-1/16" - 5").
Can be set on counter top or hung on a wall using the built-in hanger loops. Durable black powder coat finish with black and white sign panel.

Can be shipped via UPS

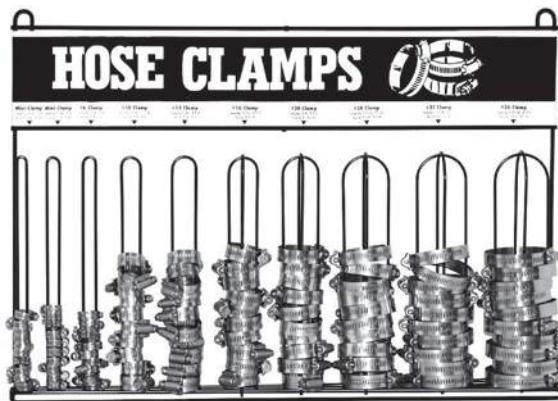

No. 10-HCR

10 Loop Hose Clamp Rack

23-1/4" Wide x 5-3/8" Deep x 16-1/8" High
Holds 10 sizes of clamp diameters:
Mini-clamp (7/32" - 5/8"), Mini-clamp (5/16" - 7/8"), #6 (3/8" to 7/8"), #10 (9/16" to 1-1/16"), #12 (9/16" to 1-1/4"), #16 (11/16" to 1-1/2"), #20 (3/4" to 1-3/4"), #28 (1-5/16" to 2-1/4"), #32 (1-9/16" to 2-1/2") and #36 (1-13/16" to 2-3/4").
Can be set on counter top or hung on a wall using the built-in hanger loops. Durable black powder coat finish with black and white sign panel.

Can be shipped via UPS

BINS



P277
40 Compartment Bin
33-3/4" Wide x 12" Deep x 24" High
Shipping Wt. 47 lbs. per carton
Packing: 1 Set up unit per carton
Color: green or gray enamel finish

Can be shipped via UPS

P40-S
40 Compartment Bin
33-3/4" Wide x 9" Deep x 24" High
Shipping Wt. 38 lbs. per carton
Packing: 1 set up unit per carton
Color: green enamel finish

Can be shipped via UPS

72B-9
72 Compartment Bin
33-3/4" Wide x 9" Deep x 42" High
Shipping Weight: 75 lbs.
Packing: 1 Set up in two cartons
Color: green enamel finish
(Sold as a set only)

Can be shipped via UPS

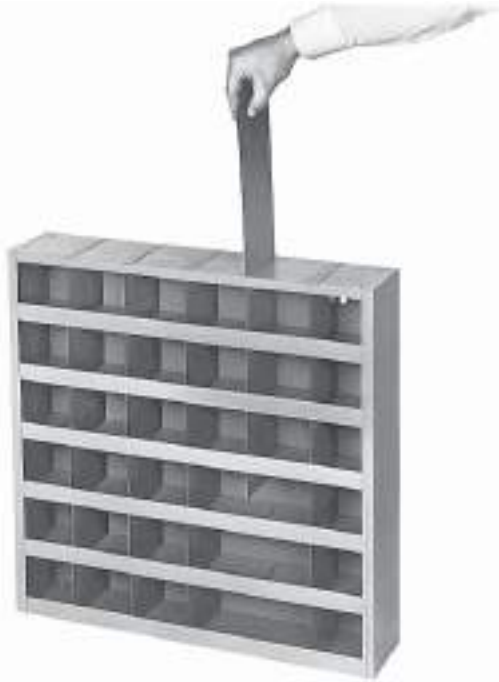

MB-36
Multi-Purpose Bin
23-5/8" Wide x 4-3/4" Deep x 23-5/8" High.
Removable vertical dividers allow the creation of double-width openings, each with scoops. Keyhole slots are provided for wall mounting.
Shipping Weight: 25 lbs. per carton

Can be shipped via UPS



18-CB
18 Compartment Bin
33-3/4" Wide x 12" Deep x 19-1/4" High
Shipping Weight: 38 lbs. Per carton

Can be shipped via UPS

BIN ACCESSORIES & CABINETS

Bin Bases



B-1

Base For Bins P277 & 18-D

Raises units 4 or 8 inches off the floor
Color: green enamel finish

UNIT PACKAGE: 1

Can be shipped via UPS

B-2

Base for Bin P40-S & P72B-9

Raises unit 4 or 8 inches off the floor
Color: green enamel finish

UNIT PACKAGE: 1

Can be shipped via UPS



18-D

18 Drawer Cabinet (With 36 Dividers)

34" Wide x 11-1/4" Deep x 11" High

Shipping Wt. 47 lbs.

Color: standard green enamel finish

Can be shipped via UPS



Dividers

For 18-D and 9-D

Plastic

2-1/2" x 5-3/16"

UNIT PACKAGE: 1



1-ACC

Aerosol Can Caddy

21-1/2" Wide x 3-1/8" Deep x 5-1/4" High

Holds 6 cans with a maximum can diameter of 3"

Holes are provided for wall mounting.

Shipping Weight: 2 lbs. per carton

Can be shipped via UPS



9-D

9 Drawer Cabinet (With 18 Dividers)

17-1/4" Wide x 11-5/8" Deep x 10-7/8" High

Shipping Wt. 28 lbs. per carton

Can be shipped via UPS

BIN LABELS



2" x 3/4" Pressure Sensitive Bin Labels Covering Popular Size U.S.S., S.A.E. and Metric Fasteners. 36 Labels Per Each 6-1/4" x 9" Page.

15531

U.S.S. Fastener Labels for Cap Screws, Nuts, Lock Washers, Flat Washers and Blanks

Diameters: 1/4", 5/16", 3/8", 7/16", 1/2", 9/16", 5/8", 3/4", 7/8", & 1"
Lengths: 1/2" thru 6"

Total of 6 pages

UNIT PACKAGE: 1 Set

15532

S.A.E. Fastener Labels for Cap Screws, Nuts, Lock Washers, Flat Washers and Blanks

Diameters: 1/4", 5/16", 3/8", 7/16", 1/2", 9/16", 5/8", 3/4", 7/8", & 1"
Lengths: 1/2" thru 6"

Total of 6 pages

UNIT PACKAGE: 1 Set

14773

Miscellaneous Fastener Labels for Carriage Bolts, Nuts, Flat Washers, Stove Bolts, Sheet Metal Screws, Cotter Pins and No. 3 Head Plow Bolts

Total of 6 pages

UNIT PACKAGE: 1 Set

14774

Metric Fastener Labels for Hex Cap Screws (Regular & Fine Thread), Hex Nuts, Nylon Insert Lock Nuts, Split Lock Washers, Flat Washers, Wave Washers, Socket Cap Screws and Socket Set Screws

Diameters: 4mm, 5mm, 6mm, 7mm, 8mm, 10mm, 12mm, 14mm, 16mm, 20mm & 24mm.

14775

Blank Labels
5 pages of blank labels that can be written on with a ball point pen.

UNIT PACKAGE: 1 Set

15533

Bin Labels Assortment
Consists of 1 set each of 15531, 15532, 14773, 14774 & 14775

UNIT PACKAGE: 1 Set

Total of 9 pages

UNIT PACKAGE: 1 Set

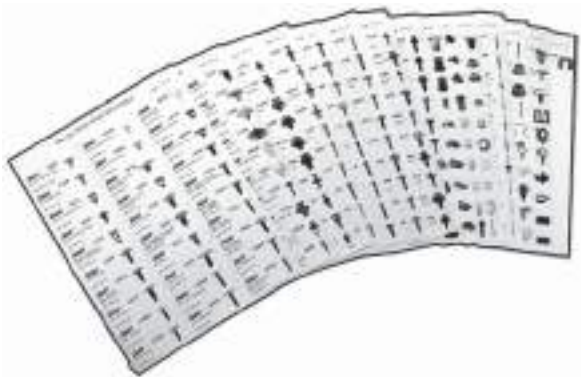

DB-425L
BODY SHOP BIN LABELS

Self-adhesive, pre-printed labels for 425 very popular Auveco body shop items. These labels are based on the contents of our DB-425 Display Boards, which are the items that we recommend everyone stock.

Each label measures 2-13/16" x 1" and contains an Auveco part number, description, OEM number, photograph and unit package quantity. Included are 25 blank labels for future new items. There are 15 pages in one set.

UNIT PACKAGE: 1 Set

BODY SHOP BIN ASSORTMENTS



Having the right part for the job is a cinch with our assortments for domestic and import vehicle applications. Each assortment contains 36 of the top selling retainers and clips along with a pre-labeled Auveco MB-36 bin.

This 36 compartment bin measures 23-5/8" wide x 4-3/4" deep x 23-5/8" high and can be shipped via UPS. In addition to showing the Auveco part number and bar code, the labels include O.E.M. numbers as well

Domestic Vehicle "Xmas Tree" & Push-Type Retainers



1052 1 Box each (1,130 pieces) of the following parts and a MB-36 bin:

10831	12757	14036	17339
11130	12759	14753	17612
11146	12766	14992	17664
11612	12909	15456	18033
12137	13993	15479	18353
12565	13996	15543	19422
12567	14010	16818	19639
12571	14020	17216	20192
12731	14021	17222	20632

1053 Same as 1052 except without MB-36 bin.

Import Vehicle Retaining Clips, Push-Type Retainers & Screw Grommets



1054 1 Box each (601 pieces) of the following parts and a MB-36 bin:

14260	18114	19239	20349
14267	18297	19246	20380
14737	18873	19274	20440
16000	18877	19453	20564
16858	18888	19552	20869
17143	19114	19721	20908
17379	19118	19729	20931
17472	19194	20247	20955
17632	19233	20327	20986

1055 Same as 1054 except without MB-36 bin.

FASTENER CABINET ASSORTMENTS

Sec. 15



Auveco offers **one-price package** assortments of popular U.S.S. and metric fasteners. Each assortment contains one box each of 60 different fasteners that are all priced the same. The assortments come in a sturdy, 5 shelf steel cabinet (15-1/2" x 32-1/2" x 4-1/4") that sits on a bench or can be wall mounted.

The assortments are shipped with the product already placed in the cabinet which is labeled with the fastener part numbers for easy re-stocking. Dimensions are clearly printed on the box labels to aid in quick selection of the proper part. All parts are available individually.

Assortment No. 70000

U.S.S. Coarse Thread Fasteners: Contains one box each of the 60 numbers listed below. Includes cabinet.

Part No.	Size	U.P. Qty.	Part No.	Size	U.P. Qty.	Part No.	Size	U.P. Qty.	Part No.	Size	U.P. Qty.
GRADE 5 U.S.S. CAP SCREWS			GRADE 5 U.S.S. CAP SCREWS (Cont'd.)			U.S.S. HEX NUTS			U.S.S. WASHERS		
70100	1/4-20 x 1/2	27	70117	3/8-16 x 1-1/2	7	70132	1/4-20	42	70147	1/4"	80
70101	1/4-20 x 3/4	23	70118	3/8-16 x 1-3/4	7	70133	5/16-18	34	70148	5/16"	50
70102	1/4-20 x 1	20	70119	3/8-16 x 2	6	70134	3/8-16	26	70149	3/8"	40
70103	1/4-20 x 1-1/4	17	70120	3/8-16 x 2-1/4	6	70135	7/16-14	15	70150	7/16"	20
70104	1/4-20 x 1-1/2	14	70121	3/8-16 x 2-1/2	5	70136	1/2-13	10	70151	1/2"	15
70105	1/4-20 x 2	10	70122	3/8-16 x 3	4	LOCK WASHERS			COTTER PINS		
70106	5/16-18 x 3/4	17	70123	7/16-14 x 1	7	70137	1/4"	100	70152	1/16 x 1	125
70107	5/16-18 x 1	14	70124	7/16-14 x 1-1/4	6	70138	5/16"	85	70153	3/32 x 1	100
70108	5/16-18 x 1-1/4	11	70125	7/16-14 x 1-1/2	5	70139	3/8"	50	70154	3/32 x 1-1/2	80
70109	5/16-18 x 1-1/2	10	70126	7/16-14 x 2	4	70140	7/16"	40	70155	1/8 x 1-1/2	50
70110	5/16-18 x 1-3/4	9	70127	7/16-14 x 2-1/2	4	70141	1/2"	23	70156	1/8 x 2	35
70111	5/16-18 x 2	7	70128	1/2-13 x 1-1/2	4	S.A.E. WASHERS			70157	5/32 x 1-1/2	30
70112	5/16-18 x 2-1/2	6	70129	1/2-13 x 2	3	70142	1/4"	90	70158	5/32 x 2	25
70113	5/16-18 x 3	5	70130	1/2-13 x 2-1/2	3	70143	5/16"	80	70159	3/16 x 2	20
70114	3/8-16 x 3/4	11	70131	1/2-13 x 3	2	70144	3/8"	60			
70115	3/8-16 x 1	10				70145	7/16"	50			
70116	3/8-16 x 1-1/4	9				70146	1/2"	27			

Assortment No. 71000

Metric Standard Pitch & Fine Pitch Fasteners: Contains one box each of the 60 numbers listed below. Includes cabinet.

Part No.	Size	U.P. Qty.	Part No.	Size	U.P. Qty.	Part No.	Size	U.P. Qty.	Part No.	Size	U.P. Qty.
STANDARD PITCH CAP SCREWS			STANDARD PITCH CAP SCREWS (Cont'd.)			LOCK WASHERS			FINE PITCH CAP SCREWS		
71101	M5-.80 x 12MM	25	71118	M8-1.25 x 45MM	7	71134	5MM	60	71147	M8-1.0 x 35MM	6
71102	M5-.80 x 25MM	20	71119	M8-1.25 x 50MM	7	71135	6MM	45	71148	M8-1.0 x 50MM	5
71103	M6-1.0 x 10MM	20	71120	M8-1.25 x 60MM	6	71136	8MM	25	71149	M10-1.0 x 30MM	4
71104	M6-1.0 x 12MM	20	71121	M8-1.25 x 75MM	5	71137	10MM	20	71150	M10-1.0 x 50MM	3
71105	M6-1.0 x 16MM	18	71122	M10-1.5 x 20MM	6	FLAT WASHERS			71151	M10-1.25 x 20MM	5
71106	M6-1.0 x 20MM	17	71123	M10-1.5 x 25MM	6	71138	5MM	60	71152	M10-1.25 x 25MM	4
71107	M6-1.0 x 25MM	16	71124	M10-1.5 x 30MM	5	71139	6MM	50	71153	M10-1.25 x 30MM	4
71108	M6-1.0 x 30MM	14	71125	M10-1.5 x 35MM	5	71140	8MM	42	71154	M10-1.25 x 35MM	4
71109	M6-1.0 x 40MM	13	71126	M10-1.5 x 40MM	5	71141	10MM	24	71155	M10-1.25 x 40MM	3
71110	M6-1.0 x 45MM	11	71127	M10-1.5 x 50MM	4	COTTER PINS			71156	M10-1.25 x 50MM	3
71111	M8-1.25 x 12MM	12	71128	M10-1.5 x 60MM	4	71142	2MM x 20MM	82	71157	M10-1.25 x 60MM	2
71112	M8-1.25 x 16MM	12	71129	M10-1.5 x 70MM	3	71143	3MM x 25MM	60	FINE PITCH HEX NUTS		
71113	M8-1.25 x 20MM	12	STANDARD PITCH HEX NUTS			71144	5MM x 45MM	20	71158	M8-1.00	17
71114	M8-1.25 x 25MM	11	71130	M5-.80	41	STUDS			71159	M10-1.00	12
71115	M8-1.25 x 30MM	10	71131	M6-1.0	25	71145	M8-1.25 x 35MM	3	71160	M10-1.25	9
71116	M8-1.25 x 35MM	9	71132	M8-1.25	17	71146	M8-1.25 x 45MM	3			
71117	M8-1.25 x 40MM	8	71133	M10-1.5	15						

FASTENER ASSORTMENTS



Two assortments of Grade 5 and Grade 8 fasteners. As always all parts are certified to meet or exceed the proper S.A.E. specifications both physically and chemically.

Each assortment includes an Auveco 40 compartment bin P40-S (33-3/4" Wide x 9" Deep x 24" High, can be shipped via UPS). The reorder labels contain the fastener part number, size, description and bar code.

1020 Grade 5 U.S.S. (Coarse Thread) Fastener Assortment. Over 2800 pieces of Grade 5 U.S.S. cap screws, hex nuts, high alloy lock washers and high alloy S.A.E. flat washers. Diameters: 1/4"-20, 5/16"-18, 3/8"-16, 7/16"-14 and 1/2"-13. Lengths: 1/2" through 3". All fasteners are zinc plated. Refer to contents listing on next page.

1021 Same as 1020 except without P40-S bin . Includes planogram and reorder labels.

1030 Grade 8 U.S.S. (Coarse Thread) Fastener Assortment. Over 2000 pieces of Grade 8 U.S.S. cap screws, hex nuts, high alloy lock washers and high alloy S.A.E. flat washers. Diameters: 1/4"-20, 5/16"-18, 3/8"-16, 7/16"-14, 1/2"-13 and 5/8"-11. Lengths: 1/2" through 4". All fasteners are zinc plated. Refer to contents listing on next page.

1031 Same as 1030 except without P40-S bin. Includes planogram and reorder labels.

Metric Fastener Assortments

1040 Metric Fastener (Regular Pitch) Assortment. Over 1200 metric cap screws, hex nuts, lock washers and flat washers with a pre-labeled Auveco 40 compartment bin, P40-S (33-3/4" Wide x 9" Deep x 24" High can be shipped via UPS). The reorder labels contain the fastener part number, size, description and bar code. Diameters: 6mm-1.00, 8mm-1.25, 10mm-1.50 and 12mm-1.75. Lengths: 10mm through 50mm. All fasteners are zinc plated. Refer to contents listing on next page.

1041 Same as 1040 except without P40-S Bin. Includes planogram and reorder labels.

1042 Metric Fastener (Regular Pitch & Fine Pitch) Assortment. Over 1995 metric cap screws, hex nuts, lock washers and flat washers with an Auveco 72B-9 (72 compartment bin). The 72B-9 measures 33-3/4" wide x 9" deep x 42" high and can be shipped via UPS. The bin is pre-labeled showing the Auveco part number, a bar code, size and description. Diameters: M5-.8, M6-1.0, M8-1.25, M8-1.0, M10-1.5, M10-1.25, M10-1.0 & M12-1.75. Lengths: 10mm through 75mm. All fasteners are zinc plated except fine pitch cap screws which have a black finish. Refer to contents listing on following pages.

1043 Same as 1042 except without 72-9 Bin. Includes planogram and reorder labels.

(Continued on next page)

FASTENER ASSORTMENT CONTENTS

1020 & 1021 Grade 5 U.S.S. (Coarse Thread) Fastener Assortments. Contain 1 Box each of:

5434	1/4"-20 x 1/2" Cap Screw	5480	7/16"-14 x 2" Cap Screw
5436	1/4"-20 x 3/4" Cap Screw	5488	1/2"-13 x 1-1/2" Cap Screw
5438	1/4"-20 x 1" Cap Screw	5490	1/2"-13 x 2" Cap Screw
5439	1/4"-20 x 1-1/4" Cap Screw	5491	1/2"-13 x 2-1/2" Cap Screw
5440	1/4"-20 x 1-1/2" Cap Screw	5492	1/2"-13 x 3" Cap Screw
5442	1/4"-20 x 2" Cap Screw	11925	1/4" High Alloy Lock Washer
5449	5/16"-18 x 3/4" Cap Screw	11926	5/16" High Alloy Lock Washer
5451	5/16"-18 x 1" Cap Screw	11927	3/8" High Alloy Lock Washer
5452	5/16"-18 x 1-1/4" Cap Screw	11928	7/16" High Alloy Lock Washer
5453	5/16"-18 x 1-1/2" Cap Screw	11929	1/2" High Alloy Lock Washer
5455	5/16"-18 x 2" Cap Screw	12781	1/4" High Strength SAE Washer
5463	3/8"-16 x 3/4" Cap Screw	12782	5/16" High Strength SAE Washer
5465	3/8"-16 x 1" Cap Screw	12783	3/8" High Strength SAE Washer
5466	3/8"-16 x 1-1/4" Cap Screw	12784	7/16" High Strength SAE Washer
5467	3/8"-16 x 1-1/2" Cap Screw	12785	1/2" High Strength SAE Washer
5468	3/8"-16 x 1-3/4" Cap Screw	15586	1/4"-20 Grade 5 Hex Nut
5469	3/8"-16 x 2" Cap Screw	15587	5/16"-18 Grade 5 Hex Nut
5471	3/8"-16 x 2-1/2" Cap Screw	15588	3/8"-16 Grade 5 Hex Nut
5476	7/16"-14 x 1" Cap Screw	15589	7/16"-14 Grade 5 Hex Nut
5478	7/16"-14 x 1-1/2" Cap Screw	15590	1/2"-13 Grade 5 Hex Nut

1030 & 1031 Grade 8 U.S.S. (Coarse Thread) Fastener Assortments. Contain 1 box each of:

9118	1/4"-20 x 1/2" Cap Screw	17499	5/8"-11 x 3-1/2" Cap Screw
9119	1/4"-20 x 3/4" Cap Screw	9164	5/8"-11 x 4" Cap Screw
9120	1/4"-20 x 1" Cap Screw	11925	1/4" High Alloy Lock Washer
9122	1/4"-20 x 1-1/2" Cap Screw	11926	5/16" High Alloy Lock Washer
9128	5/16"-18 x 3/4" Cap Screw	11927	3/8" High Alloy Lock Washer
9129	5/16"-18 x 1" Cap Screw	11928	7/16" High Alloy Lock Washer
9131	5/16"-18 x 1-1/2" Cap Screw	11929	1/2" High Alloy Lock Washer
9137	3/8"-16 x 1" Cap Screw	11931	5/8" High Alloy Lock Washer
9138	3/8"-16 x 1-1/4" Cap Screw	12781	1/4" High Strength SAE Washer
9139	3/8"-16 x 1-1/2" Cap Screw	12782	5/16" High Strength SAE Washer
9140	3/8"-16 x 2" Cap Screw	12783	3/8" High Strength SAE Washer
9141	3/8"-16 x 2-1/2" Cap Screw	12784	7/16" High Strength SAE Washer
9146	7/16"-14 x 1-1/2" Cap Screw	12785	1/2" High Strength SAE Washer
9147	7/16"-14 x 2" Cap Screw	12787	5/8" High Strength SAE Washer
9153	1/2"-13 x 1-1/2" Cap Screw	15640	1/4"-20 Grade 8 Hex Nut
9155	1/2"-13 x 2" Cap Screw	15641	5/16"-18 Grade 8 Hex Nut
9156	1/2"-13 x 2-1/2" Cap Screw	15642	3/8"-16 Grade 8 Hex Nut
9157	1/2"-13 x 3" Cap Screw	15643	7/16"-14 Grade 8 Hex Nut
9161	5/8"-11 x 2" Cap Screw	15644	1/2"-13 Grade 8 Hex Nut
9163	5/8"-11 x 3" Cap Screw	15645	5/8"-11 Grade 8 Hex Nut

1040 & 1041 Metric Fastener (Regular Pitch) Assortments. Contain 1 box each of:

14584	6mm-1.00 x 10mm Cap Screw	(DIN 933)	14434	10mm-1.50 x 40mm Cap Screw	(DIN 931)
14407	6mm-1.00 x 12mm Cap Screw	(DIN 933)	14435	10mm-1.50 x 45mm Cap Screw	(DIN 931)
14408	6mm-1.00 x 16mm Cap Screw	(DIN 933)	14436	10mm-1.50 x 50mm Cap Screw	(DIN 931)
14409	6mm-1.00 x 20mm Cap Screw	(DIN 933)	14440	12mm-1.75 x 25mm Cap Screw	(DIN 933)
14410	6mm-1.00 x 25mm Cap Screw	(DIN 933)	14441	12mm-1.75 x 30mm Cap Screw	(DIN 933)
14411	6mm-1.00 x 30mm Cap Screw	(DIN 931)	14442	12mm-1.75 x 35mm Cap Screw	(DIN 933)
14412	6mm-1.00 x 35mm Cap Screw	(DIN 931)	14443	12mm-1.75 x 40mm Cap Screw	(DIN 933)
14413	6mm-1.00 x 40mm Cap Screw	(DIN 931)	14445	12mm-1.75 x 50mm Cap Screw	(DIN 931)
14419	8mm-1.25 x 16mm Cap Screw	(DIN 933)	14450	6mm-1.00 Hex Nut	(DIN 934)
14420	8mm-1.25 x 20mm Cap Screw	(DIN 933)	14452	8mm-1.25 Hex Nut	(DIN 934)
14421	8mm-1.25 x 25mm Cap Screw	(DIN 933)	14454	10mm-1.50 Hex Nut	(DIN 934)
14422	8mm-1.25 x 30mm Cap Screw	(DIN 933)	14455	12mm-1.75 Hex Nut	(DIN 934)
14423	8mm-1.25 x 35mm Cap Screw	(DIN 931)	10579	6mm Flat Washer	(DIN 125)
14424	8mm-1.25 x 40mm Cap Screw	(DIN 931)	10581	8mm Flat Washer	(DIN 125)
14425	8mm-1.25 x 45mm Cap Screw	(DIN 931)	10582	10mm Flat Washer	(DIN 125)
14426	8mm-1.25 x 50mm Cap Screw	(DIN 931)	10583	12mm Flat Washer	(DIN 125)
14430	10mm-1.50 x 20mm Cap Screw	(DIN 933)	10586	6mm Lock Washer	(DIN 127)
14431	10mm-1.50 x 25mm Cap Screw	(DIN 933)	10588	8mm Lock Washer	(DIN 127)
14432	10mm-1.50 x 30mm Cap Screw	(DIN 933)	10589	10mm Lock Washer	(DIN 127)
14433	10mm-1.50 x 35mm Cap Screw	(DIN 933)	10590	12mm Lock Washer	(DIN 127)

FASTENER ASSORTMENT CONTENTS

1042 & 1043 Metric Fastener (Regular Pitch & Fine Pitch) Assortments. Contain one box each of:

14583 5mm-.8 x 12mm Cap Screw	(DIN 933)	14441 12mm-1.75 x 30mm Cap Screw	(DIN 933)
14403 5mm-.8 x 16mm Cap Screw	(DIN 933)	14442 12mm-1.75 x 35mm Cap Screw	(DIN 933)
14404 5mm-.8 x 20mm Cap Screw	(DIN 933)	14443 12mm-1.75 x 40mm Cap Screw	(DIN 933)
14405 5mm-.8 x 25mm Cap Screw	(DIN 933)	14445 12mm-1.75 x 50mm Cap Screw	(DIN 931)
14406 5mm-.8 x 30mm Cap Screw	(DIN 933)	14446 12mm-1.75 x 60mm Cap Screw	(DIN 931)
15512 5mm-.8 x 40mm Cap Screw	(DIN 933)	14447 12mm-1.75 x 70mm Cap Screw	(DIN 931)
14584 6mm-1.0 x 10mm Cap Screw	(DIN 933)	14449 5mm-.8 Hex Nut	(DIN 934)
14407 6mm-1.0 x 12mm Cap Screw	(DIN 933)	14450 6mm-1.0 Hex Nut	(DIN 934)
14408 6mm-1.0 x 16mm Cap Screw	(DIN 933)	14452 8mm-1.25 Hex Nut	(DIN 934)
14409 6mm-1.0 x 20mm Cap Screw	(DIN 933)	14454 10mm-1.5 Hex Nut	(DIN 934)
14410 6mm-1.0 x 25mm Cap Screw	(DIN 933)	14455 12mm-1.75 Hex Nut	(DIN 934)
14411 6mm-1.0 x 30mm Cap Screw	(DIN 931)	10578 5mm Flat Washer	(DIN 125)
14412 6mm-1.0 x 35mm Cap Screw	(DIN 931)	10579 6mm Flat Washer	(DIN 125)
14413 6mm-1.0 x 40mm Cap Screw	(DIN 931)	10581 8mm Flat Washer	(DIN 125)
14585 6mm-1.0 x 50mm Cap Screw	(DIN 931)	10582 10mm Flat Washer	(DIN 125)
14588 8mm-1.25 x 12mm Cap Screw	(DIN 933)	10583 12mm Flat Washer	(DIN 125)
14419 8mm-1.25 x 16mm Cap Screw	(DIN 933)	10585 5mm Lock Washer	(DIN 127)
14420 8mm-1.25 x 20mm Cap Screw	(DIN 933)	10586 6mm Lock Washer	(DIN 127)
14421 8mm-1.25 x 25mm Cap Screw	(DIN 933)	10588 8mm Lock Washer	(DIN 127)
14422 8mm-1.25 x 30mm Cap Screw	(DIN 933)	10589 10mm Lock Washer	(DIN 127)
14423 8mm-1.25 x 35mm Cap Screw	(DIN 931)	10590 12mm Lock Washer	(DIN 127)
14424 8mm-1.25 x 40mm Cap Screw	(DIN 931)	11258 8mm-1.0 x 35mm Fine Cap Screw	(DIN 961)
14425 8mm-1.25 x 45mm Cap Screw	(DIN 931)	14604 8mm-1.0 x 50mm Fine Cap Screw	(DIN 960)
14426 8mm-1.25 x 50mm Cap Screw	(DIN 931)	14605 10mm-1.25 x 20mm Fine Cap Screw	(DIN 961)
14428 8mm-1.25 x 60mm Cap Screw	(DIN 931)	11265 10mm-1.25 x 25mm Fine Cap Screw	(DIN 961)
14429 8mm-1.25 x 70mm Cap Screw	(DIN 933)	11266 10mm-1.25 x 30mm Fine Cap Screw	(DIN 961)
14589 8mm-1.25 x 75mm Cap Screw	(DIN 931)	11267 10mm-1.25 x 35mm Fine Cap Screw	(DIN 961)
14430 10mm-1.5 x 20mm Cap Screw	(DIN 933)	11268 10mm-1.25 x 40mm Fine Cap Screw	(DIN 961)
14431 10mm-1.5 x 25mm Cap Screw	(DIN 933)	11269 10mm-1.25 x 50mm Fine Cap Screw	(DIN 961)
14432 10mm-1.5 x 30mm Cap Screw	(DIN 933)	14606 10mm-1.25 x 60mm Fine Cap Screw	(DIN 961)
14433 10mm-1.5 x 35mm Cap Screw	(DIN 933)	11262 10mm-1.0 x 30mm Fine Cap Screw	(DIN 961)
14434 10mm-1.5 x 40mm Cap Screw	(DIN 931)	11264 10mm-1.0 x 50mm Fine Cap Screw	(DIN 961)
14435 10mm-1.5 x 45mm Cap Screw	(DIN 931)	14453 8mm-1.0 Fine Pitch Hex Nut	(DIN 934)
14436 10mm-1.5 x 50mm Cap Screw	(DIN 931)	14457 10mm-1.25 Fine Pitch Hex Nut	(DIN 934)
14438 10mm-1.5 x 60mm Cap Screw	(DIN 931)	14456 10mm-1.0 Fine Pitch Hex Nut	(DIN 934)
14439 10mm-1.5 x 70mm Cap Screw	(DIN 931)		
14440 12mm-1.75 x 25mm Cap Screw	(DIN 933)		



Auveco offers more than 40 prepackaged "FIX-KITS"® in the "6000" series small drawer. Each drawer measures 13-5/16" wide x 9-1/4" deep x 2" high.

Printed lid labels identify the correct Auveco part number for ordering refills.

"6000 Series Small Drawer "Fix-Kit"® Numeric Listing

Auveco Part No.	Description	Auveco Part No.	Description
6003	Phillips Oval Head Tapping Screws	6128	Grease Fittings
6004	Special Tapping Screws	6133	Insulated Closed Clamps
6007	Tubular, Flat, "U" & "J" Nuts	6144	Teks® Tapping Screws
6011	Round Head Machine Screws & Nuts	6158	Metric Cotter Pins
6038	Phillips Pan Head Tapping Screws	6160	Metric Cap Screws & Nuts
6043	Thread Cutting & Washer Lock Nuts	6162	"Xmas Tree" Retainers
6051	Cotter Pins	6164	Pushnut Bolt Retainers
6060	Universal Clevis Pins	6166	Body & Fender Shims
6062	Plug Buttons	6167	Tee Connectors
6065	Woodruff Keys	6168	Hose Connectors
6070	Internal & External Lock Washers	6172	Push-On Retainers & Bolt Retainers
6073	Socket Head Set Screws	6173	Solderless Terminals
6085	"O" Rings	6175	Solderless Terminals
6086	Throttle Rod Clips & E-Clips	6176	Thread Repair Inserts
6112	Cotter Pins	6178	O.E.M. Electrical Terminals
6116	Internal & External Retaining Rings	6182	Phillips Washer Head Tapping Screws
6123	"E" Rings	6186	Oil Drain Plugs & Gaskets
6124	Spring Pins	6187	Metric Grease Fittings
6125	Spring Pins		

"6000" Series/"6500" Series Kit Cross Reference

"6000" Kit	"6500" Kit	"6000" Kit	"6500" Kit	"6000" Kit	"6500" Kit
6003	6501	6116	6507	6144	6536
6007	6502	6123	6508	6160	6513
6011	6503	6124	6509	6178	6543
6065	6504	6125	6510	6182	6530
6085	6505	6128	6511	6186	6534
6112	6506				

The 6600 Series Body Hardware Master Assortments are listed on pages 270-276



No. 6003 “Fix-Kit”
Phillips Oval Head Tapping Screws
Zinc & Chrome Plated
24 Varieties - 540 Pieces

Auveco Part No.	Size	Head
3069	#4 x 3/4"	
1793	#6 x 5/8"	
1794	#6 x 3/4"	
1796	#6 x 1"	
1797	#6 x 1-1/4"	
2024	#8 x 3/8"	No.6
2358	#8 x 1/2"	
2027	#8 x 1/2"	No. 6
1421	#8 x 5/8"	No. 6
1799	#8 x 3/4"	No. 6
2359	#8 x 3/4"	
1801	#8 x 1"	No. 6
1802	#8 x 1-1/8"	No. 6
2361	#8 x 1-1/4"	
1803	#8 x 1-1/4"	No. 6
2362	#8 x 1-1/2"	
1932	#8 x 1-1/2"	No. 6
1933	#8 x 1-3/4"	No. 6
1717	#10 x 3/4"	No. 8
2728	#10 x 3/4"	
1804	#10 x 1"	No. 6
1807	#10 x 1-1/8"	
2046	#10 x 1-1/2"	No. 6
2665	#10 x 2"	No. 8



No. 6038 “Fix-Kit”
Phillips Pan Head Tapping Screws
Zinc Plated
20 Varieties - 1385 Pieces

Auveco Part No.	Size
3071	#4 x 1/4"
3072	#4 x 3/8"
3073	#4 x 1/2"
3074	#4 x 3/4"
3075	#4 x 1"
1935	#6 x 1/4"
1936	#6 x 3/8"
1937	#6 x 1/2"
5621	#6 x 5/8"
2364	#6 x 3/4"
3076	#6 x 1"
3077	#6 x 1-1/4"
3078	#6 x 1-1/2"
1939	#8 x 3/8"
1940	#8 x 1/2"
5625	#8 x 5/8"
2365	#8 x 3/4"
3079	#8 x 1"
3080	#8 x 1-1/4"
3081	#8 x 1-1/2"



No. 6182 “Fix-Kit”
Phillips Flat Top Washer Head
Tapping Screws
Black “E” Coat Plated
12 Varieties -1790 Pieces

Auveco Part No.	Size	Head
12950	#6 x 1/2"	Black E Coat
12951	#6 x 3/4"	Black E Coat
12213	#8 x 1/2"	Black E Coat
12214	#8 x 5/8"	Black E Coat
12215	#8 x 3/4"	Black E Coat
12216	#8 x 1"	Black E Coat
12217	#8 x 1-1/4"	Black E Coat
12218	#8 x 1-1/2"	Black E Coat
12953	#10 x 3/4"	Black E Coat
12954	#10 x 1"	Black E Coat
14859	#8 x 1/2"	Zinc
14861	#8 x 3/4"	Zinc



No. 6004 “Fix-Kit”
Phillips Specialty Tapping Screws
Zinc Plated
24 Varieties - 795 Pieces

Auveco Part No.	Size	Head
1936	#6 x 3/8"	
1937	#6 x 1/2"	
2364	#6 x 3/4"	
1939	#8 x 3/8"	
10642	#8 x 3/8"	
2805	#8 x 7/16"	
1940	#8 x 1/2"	
12095	#8 x 1/2"	
14859	#8 x 1/2"	
15171	#8 x 1/2"	
15172	#8 x 1/2"	
1712	#8 x 3/4"	No. 6
2365	#8 x 3/4"	
3079	#8 x 1"	
2178	#10 x 3/8"	
1943	#10 x 1/2"	
2808	#10 x 5/8"	
13709	#10 x 3/4"	
2366	#10 x 3/4"	
3082	#10 x 1"	
2367	#12 x 3/4"	
3086	#12 x 1"	
3089	#14 x 1/2"	
3090	#14 x 3/4"	



No. 6144 “Fix-Kit”
Teks® Self-Drilling Screws
Phillips Pan Head
Hex Washer Head
Zinc Plated
16 Sizes - 365 Pieces

Auveco Part No.	Size	Head
9605	#8 x 1/2"	Pan
9606	#8 x 3/4"	Pan
9607	#10 x 1/2"	Pan
9608	#10 x 3/4"	Pan
11905	#12 x 1"	Pan
9611	#8 x 1/2"	Hex
9612	#8 x 3/4"	Hex
9613	#10 x 1/2"	Hex
9614	#10 x 5/8"	Hex
9615	#10 x 3/4"	Hex
9616	#10 x 1"	Hex
11911	#12 x 1"	Hex
9620	#14 x 3/4"	Hex
11914	#14 x 1"	Hex
11915	#14 x 1-1/4"	Hex
11916	#14 x 1-1/2"	Hex

You Can E-mail
Your Suggestions
For New Assortments
To mail@auveco.com
We Welcome All
Your Suggestions.

Sec. 15 "6000" SERIES SMALL DRAWER "FIX-KITS"



No. 6011 "Fix-Kit"

Slotted Round Head
Machine Screws
Zinc Plated
19 Varieties of Screws
5 Varieties of Nuts - 1110 Pieces

Auveco Part No.	Size	
727	6-32	Nut
728	8-32	Nut
729	10-32	Nut
730	10-24	Nut
731	12-24	Nut
2530	6-32 x 1/2"	
2531	6-32 x 3/4"	
2532	6-32 x 1"	
2533	8-32 x 1/2"	
2534	8-32 x 3/4"	
2535	8-32 x 1"	
2536	10-32 x 1/2"	
2537	10-32 x 3/4"	
2538	10-32 x 1"	
2539	10-32 x 1-1/4"	
2540	10-32 x 1-1/2"	
2541	10-24 x 1/2"	
2542	10-24 x 3/4"	
2543	10-24 x 1"	
2544	10-24 x 1-1/4"	
2545	10-24 x 1-1/2"	
2546	12-24 x 1/2"	
2548	12-24 x 1"	
2550	12-24 x 1-1/2"	



No. 6160 "Fix-Kit"

Metric Regular Pitch
Cap Screws & Nuts
DIN 933
Zinc Plated
12 Varieties Of Screws
4 Varieties Of Nuts - 236 Pieces

Auveco Part No.	Size	
14400	M4-.7 x 16mm	
14401	M4-.7 x 20mm	
14402	M5-.8 x 10mm	
14403	M5-.8 x 16mm	
14404	M5-.8 x 20mm	
14405	M5-.8 x 25mm	
14408	M6-1.0 x 16mm	
14409	M6-1.0 x 20mm	
14410	M6-1.0 x 25mm	
14420	M8-1.25 x 20mm	
14421	M8-1.25 x 25mm	
14422	M8-1.25 x 30mm	
14448	M4-.7 Nut	
14449	M5-.8 Nut	
14450	M6-1.0 Nut	
14452	M8-1.25 Nut	



No. 6073 "Fix-Kit"

Socket Head Set Screws
47 Varieties Screws
540 Pieces

Auveco Part No.	Size		
5366	6-32 x 1/4"		
5367	6-32 x 5/16"		
5368	6-32 x 3/8"		
5370	8-32 x 1/4"		
5371	8-32 x 5/16"		
5372	8-32 x 3/8"		
5373	8-32 x 1/2"		
Auveco Part No.	USS	SAE	Size
5374	5394		10 x 3/16"
5375	5395		10 x 1/4"
5376	5396		10 x 5/16"
5377	5397		10 x 3/8"
5378	5398		10 x 1/2"
5379	5399		1/4 x 1/4"
5380	5400		1/4 x 5/16"
5381	5401		1/4 x 3/8"
5382	5402		1/4 x 7/16"
5383	5403		1/4 x 1/2"
5384	5404		5/16 x 1/4"
5385	5405		5/16 x 5/16"
5386	5406		5/16 x 3/8"
5387	5407		5/16 x 7/16"
5388	5408		5/16 x 1/2"
5389	5409		3/8 x 5/16"
5390	5410		3/8 x 3/8"
5391	5411		3/8 x 7/16"
5392	5412		3/8 x 1/2"
5393	5413		3/8 x 5/8"

Remember....
All Items In This
Catalog Are
Available In Bulk.
Call For A Quote.



No. 6007 "Fix-Kit"

Tubular, Flat, "U" & "J" Nuts
24 Varieties - 515 Pieces

Auveco Part No.	Size	
1903	1/4"-20	Flat
2089	#6-32	Flat
2092	#10-24	Flat
2099	1/8" Stud	Flat
2103	3/16" Stud	Flat
2105	1/4" Stud	Flat
2293	1/4"-20	"U"
2346	#8	"J"
2422	#10	"U"
2595	1/8" Stud	Tubular
2611	1/8" Stud	Tubular
5170	3/8"-16	"J" Cage
5197	#10-24	"U"
5586	1/4"-20	"J" Cage
5589	5/16"-18	"J" Cage
9879	#8	Spring "U"
9880	#8	Spring "U"
10064	#6	Spring "U"
10065	#8	Spring "U"
10066	#10	Spring "U"
10067	#14	Spring "U"
10666	#8	"U"
11292	#8	"U"
11429	#10	"U"

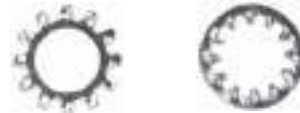

No. 6070 "Fix-Kit"

Shakeproof Lock Washers
(External - Internal Countersunk)
Zinc Plated
24 Varieties - 1450 Pieces

Auveco Part No.	Size	Type
5249	#4	External
5259	#4	Internal
5250	#6	External
5260	#6	Internal
5270	#6	Countersunk
5251	#8	External
5261	#8	Internal
5271	#8	Countersunk
5252	#10	External
5262	#10	Internal
5272	#10	Countersunk
5253	#12	External
5263	#12	Internal
5254	1/4"	External
5264	1/4"	Internal
5255	5/16"	External
5265	5/16"	Internal
5256	3/8"	External
5266	3/8"	Internal
5257	7/16"	External
5267	7/16"	Internal
5258	1/2"	External
5268	1/2"	Internal
5274	1/4"	Countersunk



No. 6186 “Fix-Kit”
Oil Drain Plugs & Gaskets
12 Varieties - 80 Pieces

Auveco Part No.	Size
14196	1/2"-20
18373	1/2"-20
18121	1/2"-20 Double Oversize
15527	M12-1.25
14677	M12-1.75
18374	M12-1.75
21047	M12-1.75
14678	M14-1.5
16308	M14-1.5
19279	M14-1.5
19773	M14-1.5
15529	M18-1.5



No. 6043 “Fix-Kit”
Washer Lock Nuts
& Thread Cutting Nuts
16 Varieties - 1235 Pieces

Auveco Part No.	Size
2554	#6-32
2555	#8-32
2556	#10-32
2557	#10-24
2560	#12-24
2561	1/4"-20
2562	1/4"-20
2895	1/8" Stud
2896	3/16" Stud
2897	1/4" Stud
3403	1/8" Stud
3404	3/16" Stud
3405	1/4" Stud
8855	5/32" Stud
10733	5/16" Stud
12253	5mm Stud



No. 6164 “Fix-Kit”
Pushnut Bolt Retainer
8 Sizes - 1350 Pieces

Auveco Part No.	For Bolt Diameter
16581	9/64" (#6)
10085	5/32" (#8)
16852	3/16" (#10)
10086	1/4"
10087	5/16"
9297	3/8"
9298	7/16"
9299	1/2"



No. 6172 “Fix-Kit”
Metric Pushnut Bolt Retainers &
Push-On Retainers
10 Sizes - 745 Pieces

Auveco Part No.	Bolt or Stud Size
12119	4.0mm Stud
12122	M5-.8
12123	M6-1.0
14980	M6-1.0
12124	M6.3-1.0
12125	M8-1.25
12259	M8-1.25
12126	M10-1.50
12260	M10-1.50
12127	M12-1.75

Auveco Display
Boards Are Great
Selling Tools.
Use Them To Help
Boost Your Sales.



No. 6086 “Fix-Kit”
Rod End Clips
And “E” Clips
16 Varieties - 560 Pieces

Auveco Part No.	Shaft Diameter	
Rod End Clips		
3609	5/32"	Right Side
3610	5/32"	Left Side
3611	3/16"	Right Side
3612	3/16"	Left Side
3613	1/4"	Right Side
3614	1/4"	Left Side
“E” Clips		
3165	1/8"	
3166	3/16"	
3167	1/4"	
3824	5/16"	Small O.D.
3628	5/16"	Large O.D.
5600	3/8"	
2672	7/16"	
5602	1/2"	
5601	9/16"	
5603	5/8"	



No. 6123 “Fix-Kit”
“E” & Reinforced “E” Rings
Groove Required
24 Varieties - 1500 Pieces

Auveco Part No.	Shaft Dia.	Type
8824	1/16"	E Type
8825	3/32"	E Type
8836	3/32"	Reinforced E
3165	1/8"	Reinforced E
8826	1/8"	E Type
3166	3/16"	Reinforced E
8827	3/16"	E Type
3167	1/4"	Reinforced E
8828	1/4"	E Type
3628	5/16"	Reinforced E
3824	5/16"	E Type
5600	3/8"	Reinforced E
8829	3/8"	E Type
2672	7/16"	Reinforced E
8830	7/16"	E Type
8837	1/2"	Reinforced E
5602	1/2"	E Type
5601	9/16"	Reinforced E
5603	5/8"	E Type
8831	3/4"	E Type
8832	7/8"	E Type
8833	1"	E Type
8834	1-3/16"	E Type
8835	1-3/8"	E Type

Sec. 15 "6000" SERIES SMALL DRAWER "FIX-KITS"



No. 6112 "Fix-Kit"

Hammer-lock
Cotter Pins
Bright Zinc Chromate
16 Varieties - 1500 Pieces

Auveco Part No.	Size
8477	1/16" x 1/2"
8478	1/16" x 3/4"
8479	1/16" x 1"
8480	1/16" x 1-1/2"
8481	3/32" x 3/4"
8482	3/32" x 1"
8484	3/32" x 1-1/2"
8485	3/32" x 2"
8486	1/8" x 1"
8487	1/8" x 1-1/4"
8488	1/8" x 1-1/2"
8490	1/8" x 2"
8491	1/8" x 1-1/2"
8492	5/32" x 1"
8493	5/32" x 1-1/2"
8494	5/32" x 2"



No. 6116 "Fix-Kit"

Basic Internal &
External Rings
Zinc Plated
24 Varieties - 1000 Pieces

Auveco Part No.	Shaft Diameter
Internal Type	
8688	1/4"
8689	5/16"
8690	3/8"
8691	7/16"
8692	1/2"
8693	9/16"
8694	5/8"
8695	3/4"
8696	7/8"
8697	1"
8698	1-1/8"
8699	1-1/4"
External Type	
8701	1/4"
8702	5/16"
8703	3/8"
8704	7/16"
8705	1/2"
8706	9/16"
8707	5/8"
8708	3/4"
8709	7/8"
8710	1"
8711	1-1/8"
8712	1-1/4"



No. 6051 "Fix-Kit"

Hammer-lock
Cotter Pins
Plain Steel
18 Varieties - 2790 Pieces

Auveco Part No.	Size
3502	1/16" x 1/2"
3503	1/16" x 3/4"
3504	1/16" x 1"
3505	1/16" x 1-1/4"
3506	1/16" x 1-1/2"
3508	1/16" x 2"
3509	3/32" x 1/2"
8481*	3/32" x 3/4"
3511	3/32" x 1"
3512	3/32" x 1-1/4"
3513	3/32" x 1-1/2"
3515	3/32" x 2"
3519	1/8" x 3/4"
3520	1/8" x 1"
3521	1/8" x 1-1/4"
3522	1/8" x 1-1/2"
8489*	1/8" x 1-3/4"
3524	1/8" x 2"

*Plated



No. 6158 "Fix-Kit"

Metric Cotter Pins
12 Sizes - 580 Pieces

Auveco Part No.	Size
10553	2 x 18mm
10554	2 x 20mm
10556	2 x 25mm
10558	3 x 25mm
10559	3 x 30mm
10560	3 x 35mm
10562	4 x 30mm
10563	4 x 35mm
10564	4 x 40mm
10566	5 x 35mm
10567	5 x 40mm
10568	5 x 45mm



No. 6085 "Fix-Kit"

Rubber "O" Rings
20 Varieties - 300 Pieces

Auveco Part No.	Inside Diameter	Outside Diameter
4305	1/8"	1/4"
4306	5/32"	9/32"
4307	3/16"	5/16"
4308	7/32"	11/32"
4309	1/4"	3/8"
4310	5/16"	7/16"
4311	3/8"	1/2"
4312	3/8"	9/16"
4313	7/16"	5/8"
4314	1/2"	11/16"
4315	9/16"	3/4"
4316	5/8"	13/16"
4317	11/16"	7/8"
4318	3/4"	15/16"
4319	3/4"	1"
4320	13/16"	1-1/16"
4321	7/8"	1-1/8"
4322	15/16"	1-3/16"
4323	1"	1-1/4"
4324	1-1/16"	1-5/16"

Do You Want Your
Customers To Know You
Use The Best Body
Hardware & Specialty
Fasteners Available?
Promotional Products And
Apparel Bearing The
Auveco Logo Promote
Your Identity As A
Professional.

"6000" SERIES SMALL DRAWER "FIX-KITS"[®]

Sec. 15



6175 "Fix-Kit"

Vinyl Insulated Solderless Terminals
24 Varieties - 164 Pieces

Auveco Part No.	Ga.	Wire Size	Stud Type
5023	22-18	#8 - #10	Ring
5026	16-14	#8 - #10	Ring
5027	16-14	#12 - 1/4"	Ring
5028	12-10	#8 - #10	Ring
5029	12-10	#12 - 1/4"	Ring
5030	12-10	1/4" - 5/16"	Ring
5031	12-10	5/16" - 3/8"	Ring
5047	22-18		Butt Connector
5048	16-14		Butt Connector
5049	12-10		Butt Connector
5067	16-14		Male Quick-Connect
5068	16-14		Female Quick-Connect
8781	16-14		Female Quick-Connect
9481	18-14		Electrical Connector
10719	16-14		Female Bullet Plug
11602	16-14		Female Bullet Plug
11605	16-14		Male Quick-Connect
11606	16-14		Female Quick-Connect
12144	16-14	5/16"-3/8"	Ring
12154	22-18		Male Quick-Connect
12155	22-18		Female Quick-Connect
12156	12-10		Male Quick-Connect
12157	12-10		Female Quick-Connect
12161	18-14		Tap Connector



No. 6173 "Fix-Kit"

Insulated Solderless Terminals
24 Varieties - 128 Pieces

Auveco Part No.	Ga.	Wire Size	Stud Type
5791	22-16		Butt Connector
5792	16-14		Butt Connector
5793	12-10		Butt Connector
9052	16-14	#4 - #6	Nylon Insulated Ring
9055	16-14	#8 - #10	Nylon Insulated Ring
9056	16-14	#12 - 1/4"	Nylon Insulated Ring
9057	16-14	1/4"-5/16"	Nylon Insulated Ring
9060	16-14	#8 - #10	Nylon Insulated Spade
9481	18-14		Electrical Connector
10719	16-14		Female Snap Plug
11602	16-14		Female Snap Plug
11605	16-14		Male Quick Slide
11606	16-14		Female Quick Slide
12145	16-14		Nylon Bullet Connector
12146	16-14		Nylon Bullet Connector
12147	18-14		Nylon Male Quick Connect
12148	16-14		Nylon Female Quick Connect
12149	22-18	#6	Nylon Insulated Ring
12150	22-18	#10	Nylon Insulated Ring
12151	12-10	#10	Nylon Insulated Ring
12152	12-10	1/4"	Nylon Insulated Ring
12153	12-10	3/8"	Nylon Insulated Ring
12161	18-14		Tap Connector
12791	22-18		Tap Connector



No. 6178 "Fix-Kit"

O.E.M. Electrical Terminals & Tools
GM, Ford & Chrysler
24 Varieties - 149 Pieces

Contains the following Auveco Part Numbers: **8774, 8776, 11948, 14153, 14154, 14462, 14880, 14881, 14882, 14883, 14884, 14885, 14887, 14888, 14889, 14892, 15497, 15498, 15499, 15504, 15935, 16004, 20815 & 20816**



No. 6128 "Fix-Kit"

Grease Fittings
12 Varieties - 145 Pieces

Auveco Part No.	Type
9257	1/4" -28 Thread,-Straight (Short)
9258	1/4" -28 Thread,-Straight (Long)
9259	1/4" -28 Thread,-Straight (Extra Long)
9260	1/4" -28 Thread, 45°
9261	1/4" -28 Thread, 90°
9262	1/8" Pipe Thread,-Straight
9264	1/8" Pipe Thread, 45°
9265	1/8" Pipe Thread, 65°-1/2
9266	1/8" Pipe Thread, 90°
9267	1/8" Pipe Thread,-Straight-Extra Long
15060	3/16" Drive Fit,-Straight
15066	1/8" Pipe Thread,-Straight-(Self-Tapping)



No. 6187 "Fix-Kit"

Metric Grease Fittings
12 Varieties - 165 Pieces

Auveco Part No.	Size
11097	6mm-1.00, Straight
11775	6mm-1.00, 45°
11776	6mm-1.00, 90°
11098	8mm-1.00, Straight
11777	8mm-1.00, 45°
11099	8mm-1.00, 90°
11778	8mm-1.25, Straight
11779	8mm-1.25, 45°
11780	8mm-1.25, 90°
11100	10mm-1.00, Straight
15067	10mm-1.00, 45°
11101	10mm-1.00, 90°

Sec. 15 "6000" SERIES SMALL DRAWER "FIX-KITS"



No. 6065 "Fix-Kit"
Woodruff Keys
1035 Carbon Steel
20 Varieties - 383 Pieces

Auveco Part No.	Size	
3877	1/8" x 1/2"	No. 3
3878	1/8" x 5/8"	No. 5
3879	1/8" x 3/4"	No. 7
3880	3/32" x 5/8"	No. 4
3881	5/32" x 5/8"	No. 6
3882	5/32" x 3/4"	No. 8
3883	5/32" x 7/8"	No. 10
3884	3/16" x 3/4"	No. 9
3885	3/16" x 7/8"	No. 11
3886	3/16" x 1"	No. 13
3887	3/16" x 1-1/8"	No. 16
3888	7/32" x 7/8"	No. 12
3889	7/32" x 1"	No. 14
3890	7/32" x 1-1/8"	No. 17
3891	1/4" x 7/8"	No. A
3892	1/4" x 1"	No. 15
3893	1/4" x 1-1/8"	No. 18
3894	1/4" x 1-1/4"	No. 21
3895	5/16" x 1"	No. B
3896	5/16" x 1-1/8"	No. C



No. 6060 "Fix-Kit"
Universal Clevis Pins
& Cotter Pins
7 Varieties - 64 Pieces
Of Clevis Pins
2 Varieties - 60 Pieces
Of Cotter Pins

Auveco Part No.	Size
Clevis Pins	
3703	1/4" x 2"
3704	5/16" x 2"
3705	3/8" x 2"
3707	1/2" x 2"
3708	7/16" x 2-1/2"
3709	1/2" x 2-1/2"
8265	1/2" x 3"
Cotter Pins	
3511	3/32" x 1"
3521	1/8" x 1-1/4"



No. 6125 "Fix-Kit"
Spring Pins
Zinc Plated
20 Varieties - 600 Pieces

Auveco Part No.	Size
9013	5/32" x 1/2"
9015	5/32" x 3/4"
9016	5/32" x 1"
9017	5/32" x 1-1/4"
9018	5/32" x 1-1/2"
9019	3/16" x 1/2"
9021	3/16" x 3/4"
9022	3/16" x 1"
9023	3/16" x 1-1/4"
9024	3/16" x 1-1/2"
9025	3/16" x 1-3/4"
9026	3/16" x 2"
9030	1/4" x 5/8"
9031	1/4" x 3/4"
9033	1/4" x 1"
9034	1/4" x 1-1/4"
9035	1/4" x 1-1/2"
9036	1/4" x 1-3/4"
9037	1/4" x 2"
9038	1/4" x 2-1/4"



No. 6124 "Fix-Kit"
Spring Pins
Zinc Plated
24 Varieties - 1475 Pieces

Auveco Part No.	Size
8981	1/16" x 3/16"
8983	1/16" x 1/2"
8985	1/16" x 3/4"
8987	1/16" x 1"
8988	5/64" x 1/4"
8989	5/64" x 1/2"
8991	5/64" x 3/4"
8992	5/64" x 1"
8993	5/64" x 1-1/4"
8994	5/64" x 1-1/2"
8995	3/32" x 5/16"
8996	3/32" x 1/2"
8998	3/32" x 3/4"
9000	3/32" x 1"
9001	3/32" x 1-1/4"
9002	3/32" x 1-1/2"
9003	1/8" x 3/8"
9004	1/8" x 1/2"
9006	1/8" x 3/4"
9008	1/8" x 1"
9009	1/8" x 1-1/4"
9010	1/8" x 1-1/2"
9011	1/8" x 1-3/4"
9012	1/8" x 2"



No. 6166 "Fix-Kit"
Body And Fender Shims
Zinc Plated
4 Varieties - 400 Pieces

Auveco Part No.	Size
2452	1-3/4" x 1-1/4" x 1/16" Thick (1/2" Slot)
2453	1-3/4" x 1-1/4" x 1/8" Thick (1/2" Slot)
3155	1-1/4" x 1-1/8" x 1/16" Thick (3/8" Slot)
3156	1-1/4" x 1-1/8" x 1/8" Thick (3/8" Slot)

For the most up-to-date information on new items available from Auveco, refer to the "Hot New Items" section of the Auveco web site (www.auveco.com)



No. 6162 “Fix-Kit”
 “Xmas Tree” Retainers
 GM-Ford-Chrysler
 8 Varieties - 320 Pieces

Contains the following Auveco Part Numbers: **10621, 11146, 11351, 11678, 11721, 11797, 12137 & 12565**



No. 6062 “Fix-Kit”
 Plug Buttons; Nickel Plated
 9 Varieties - 270 Pieces

Auveco Part No.	Hole Size
3750	1/4"
3751	3/8"
3752	1/2"
3753	5/8"
3754	3/4"
3755	7/8"
3756	1"
10231	1-1/4"
10232	1-1/2"

Please Order
 In Unit Package
 Quantities
 Not Number Of Pieces



No. 6133 “Fix-Kit”
 Steel
 Tubing Clamps
 Vinyl Coated
 Galvanized
 8 Varieties - 200 Pieces

Auveco Part No.	Tube Dia.	Hole Dia.	Width
9381	1/4"	9/32"	1/2"
9382	5/16"	9/32"	1/2"
9383	3/8"	9/32"	1/2"
9384	1/2"	9/32"	1/2"
9385	5/8"	9/32"	1/2"
9386	3/4"	9/32"	1/2"
9387	7/8"	9/32"	1/2"
9388	1"	9/32"	1/2"



No. 6176 “Fix-Kit”
 Thread Repair Inserts
 & Installation Tool
 12 Varieties - 40 Pieces

Auveco Part No.	Internal Thread Size
12374	#10-24
12375	#10-32
12376	1/4"-20
12377	1/4"-28
12378	5/16"-18
12379	5/16"-24
12380	3/8"-16
12381	3/8"-24
12382	7/16"-14
12383	7/16"-20
12384	1/2"-13
12385	1/2"-20
12404	Installation Tools



No. 6168 “Fix-Kit”
 Hose Connectors
 Barbed On All Sides
 8 Sizes - 155 Pieces

Auveco Part No.	Size
10101	1/8" x 1/8"
10102	3/16" x 3/16"
10103	1/4" x 1/4"
10104	5/16" x 5/16"
10105	3/8" x 3/8"
10106	1/4" x 3/16"
10107	3/8" x 1/4"
16961	1/2" x 1/2"



No. 6167 “Fix-Kit”
 Tee Connectors
 Barbed On All Sides
 7 Sizes - 84 Pieces

Auveco Part No.	Hose Size
10697	1/8"
10108	5/32"
10109	3/16"
10110	1/4"
14813	5/16"
11228	3/8"
11229	1/2"

Visit Our Web Site
www.auveco.com
 For Up-To-Date
 Information



4-96 Cabinet & 4 Empty Large Drawers
 (24 Compartment Drawers With Locking Latches)
 20" Wide x 15-3/4" Deep x 14-1/2" High
 Finish: Light Green Enamel
 Drawer Size: 18" Wide x 12" Deep x 3" High

2-96 Empty Cabinet. Will Hold 4 Large Drawers.

3-96 Empty Cabinet. Will Hold 2 Large Drawers
 20" Wide x 15-3/4" Deep x 8" High
 Finish: Light Green Enamel
 Drawer Size: Same as 4-96



B-3

Base For 2-96, 3-96 & 4-96
 Raises unit 15" off the floor for more convenient
 use of the bottom drawer
 Finish: Light Green Enamel

UNIT PACKAGE: 1



Empty Drawers With Locking Latches (18" Wide x 12" Deep x 3" High)
 Available in 12, 16, 20, 24 and 32 compartment layouts.



No. 1-924

- 1-900** Adjustable Compartment Empty Drawer With 3 Vertical and 3 Horizontal Dividers
- 1-901** Adjustable Compartment Empty Drawer With 9 Dividers
- 1-902** Adjustable Compartment Empty Drawer With 6 Fixed Horizontal Compartments and 12 Movable Dividers Adjustable On 1" Centers.
- 1-912** 12 Compartment Empty Drawer
- 1-916** 16 Compartment Empty Drawer
- 1-920** 20 Compartment Empty Drawer
- 1-924** 24 Compartment Empty Drawer
- 1-932** 32 Compartment Empty Drawer



Auveco offers 46 pre-packaged “Fix-Kits®” in the “6500” series large drawer. A drawer measures 18" Wide x 12" Deep x 3" High with the compartments designed to hold the entire contents of one or more standard Auveco unit packages. Printed lid labels identify the correct Auveco part number for ordering refills.

“6500” Series Large Drawer “Fix-Kit®” Numeric Listing

Auveco Part No.	Description	Auveco Part No.	Description
6501	Phillips Oval Head Tapping Screws	6536	Teks® Tapping Screws
6502	Tubular, Flat, “U” & “J” Nuts	6537	Door Hinge Pins & Bushings
6503	Round Head Machine Screws & Nuts	6538	Cylinder Head & Manifold Studs
6504	Woodruff Keys	6539	Phillips Pan Head Machine Screws & Nuts
6505	“O” Rings	6540	Metric Body Bolts & Nuts
6506	Cotter Pins	6541	Small Size U.S.S. Grade 5 Cap Screws & Nuts
6507	Internal & External Retaining Rings	6542	GM Ford & Chrysler Push-Type Retainers
6508	“E” Rings	6543	O.E.M. Terminals & Tools
6509	Spring Pins	6544	Krimp & Seal Terminals
6510	Spring Pins	6545	GM Moulding Clips
6511	Grease Fittings	6546	Hyundai & Kia Clips & Fasteners
6513	Metric Cap Screws & Nuts	6547	Volkswagen & Audi Clips & Fasteners
6514	Metric Cap Screws & Nuts	6548	Honda & Acura Retainers & Retaining Clips
6517	Nylon Nuts	6549	Honda & Acura Push-Type Retainers
6519	GM “Xmas Tree” Retainers	6550	Nissan & Infiniti Retainers & Push-Type Retainers
6520	Ford “Xmas Tree” Retainers	6551	Toyota & Lexus Retainers & Retaining Clips
6522	“Xmas Tree” Retainers	6552	Toyota & Lexus Push-Type Retainers
6523	Tee Connectors & Rubber Caps	6553	Oil Drain Plugs & Gaskets
6524	Well Nuts® & Jack Nuts®	6554	J.I.S. Hex Flange Bolts & Spin Lock Nuts
6525	Nylon Rivets	6555	Mercedes-Benz Clips & Fasteners
6530	Phillips Washer Head Tapping Screws	6556	BMW Clips & Fasteners
6532	Stainless Steel Screws, Nuts & Washers	6557	Metal Rivets
6533	Stainless Steel Tapping Screws	6558	Cable Ties & Harness Straps
6534	Oil Drain Plugs		
6535	Extension Springs		

“6500” Series/“6000” Series Kit Cross Reference

“6500” Kit	“6000” Kit	“6500” Kit	“6000” Kit	“6500” Kit	“6000” Kit
6501	6003	6507	6116	6513	6160
6502	6007	6508	6123	6530	6182
6503	6011	6509	6124	6534	6186
6504	6065	6510	6125	6536	6144
6505	6085	6511	6128	6543	6178
6506	6112				

The 6600 Series Body Hardware Master Assortments are listed on pages 270-276



No. 6501 “Fix-Kit”

Phillips Oval Head Tapping Screws
Zinc & Chrome Plated
24 Varieties - 540 Pieces

Auveco Part No.	Size	Head
3069	#4 x 3/4"	
1793	#6 x 5/8"	
1794	#6 x 3/4"	
1796	#6 x 1"	
1797	#6 x 1-1/4"	
2024	#8 x 3/8"	No. 6
2358	#8 x 1/2"	
2027	#8 x 1/2"	No. 6
1421	#8 x 5/8"	No. 6
1799	#8 x 3/4"	No. 6
2359	#8 x 3/4"	
1801	#8 x 1"	No. 6
1802	#8 x 1-1/8"	No. 6
2361	#8 x 1-1/4"	
1803	#8 x 1-1/4"	No. 6
2362	#8 x 1-1/2"	
1932	#8 x 1-1/2"	No. 6
1933	#8 x 1-3/4"	No. 6
1717	#10 x 3/4"	No. 8
2728	#10 x 3/4"	
1804	#10 x 1"	No. 6
1807	#10 x 1-1/8"	
2046	#10 x 1-1/2"	No. 6
2665	#10 x 2"	No. 8



No. 6530 “Fix-Kit”

Phillips Flat Top Washer Head
Tapping Screws
Black “E” Coat Plated
12 Varieties - 1790 Pieces

Auveco Part No	Size	Head
12950	#6 x 1/2"	Black E Coat
12951	#6 x 3/4"	Black E Coat
12213	#8 x 1/2"	Black E Coat
12214	#8 x 5/8"	Black E Coat
12215	#8 x 3/4"	Black E Coat
12216	#8 x 1"	Black E Coat
12217	#8 x 1-1/4"	Black E Coat
12218	#8 x 1-1/2"	Black E Coat
12953	#10 x 3/4"	Black E Coat
12954	#10 x 1"	Black E Coat
14859	#8 x 1/2"	Zinc
14861	#8 x 3/4"	Zinc



No. 6539 “Fix-Kit”

Phillips Pan Head
Machine Screws & Nuts
Zinc Plated
12 Varieties of Screws
4 Varieties of Nuts
2160 Pieces

Auveco Part No.	Size	Head
728	#8-32 Hex Nut	
729	#10-32 Hex Nut	
730	#10-24 Hex Nut	
733	1/4"-20 Hex Nut	
15381	#8-32 x 1/2"	
15382	#8-32 x 3/4"	
15383	#8-32 x 1"	
15387	#10-24 x 1/2"	
15388	#10-24 x 3/4"	
15389	#10-24 x 1"	
15393	#10-32 x 1/2"	
15394	#10-32 x 3/4"	
15395	#10-32 x 1"	
15398	1/4"-20 x 1/2"	
15399	1/4"-20 x 3/4"	
15400	1/4"-20 x 1"	



No. 6533 “Fix-Kit”

Stainless Steel Phillips Head
Tapping Screws
24 Varieties - 1600 Pieces

Auveco Part No.	Size	Head
9399	#6 x 1/2"	Oval
9400	#6 x 3/4"	Oval
9401	#6 x 1"	Oval
9403	#8 x 1/2"	Oval
9404	#8 x 3/4"	Oval
9405	#8 x 1"	Oval
9406	#8 x 1-1/4"	Oval
9407	#8 x 1-1/2"	Oval
9409	#10 x 3/4"	Oval
9410	#10 x 1"	Oval
9412	#12 x 1-1/2"	Oval
13265	#6 x 1/2"	Pan
13266	#6 x 3/4"	Pan
13267	#6 x 1"	Pan
13269	#8 x 1/2"	Pan
13270	#8 x 3/4"	Pan
13271	#8 x 1"	Pan
13272	#8 x 1-1/4"	Pan
13273	#8 x 1-1/2"	Pan
13274	#10 x 1/2"	Pan
13275	#10 x 3/4"	Pan
13276	#10 x 1"	Pan
13277	#10 x 1-1/4"	Pan
13278	#10 x 1-1/2"	Pan



No. 6503 “Fix-Kit”

Slotted Round Head
Machine Screws
Zinc Plated
19 Varieties of Screws
5 Varieties of Nuts
1110 Pieces

Auveco Part No.	Size	Head
727	#6-32 Nut	
728	#8-32 Nut	
729	#10-32 Nut	
730	#10-24 Nut	
731	#12-24 Nut	
2530	#6-32 x 1/2"	
2531	#6-32 x 3/4"	
2532	#6-32 x 1"	
2533	#8-32 x 1/2"	
2534	#8-32 x 3/4"	
2535	#8-32 x 1"	
2536	#10-32 x 1/2"	
2537	#10-32 x 3/4"	
2538	#10-32 x 1"	
2539	#10-32 x 1-1/4"	
2540	#10-32 x 1-1/2"	
2541	#10-24 x 1/2"	
2542	#10-24 x 3/4"	
2543	#10-24 x 1"	
2544	#10-24 x 1-1/4"	
2545	#10-24 x 1-1/2"	
2546	#12-24 x 1/2"	
2548	#12-24 x 1"	
2550	#12-24 x 1-1/2"	



No. 6536 “Fix-Kit”

Teks® Self-Drilling Screws
Phillips Pan Head
Hex Washer Head
Zinc Plated
16 Varieties - 365 Pieces

Auveco Part No.	Size	Head
9605	#8 x 1/2"	Pan
9606	#8 x 3/4"	Pan
9607	#10 x 1/2"	Pan
9608	#10 x 3/4"	Pan
11905	#12 x 1"	Pan
9611	#8 x 1/2"	Hex
9612	#8 x 3/4"	Hex
9613	#10 x 1/2"	Hex
9614	#10 x 5/8"	Hex
9615	#10 x 3/4"	Hex
9616	#10 x 1"	Hex
11911	#12 x 1"	Hex
9620	#14 x 3/4"	Hex
11914	#14 x 1"	Hex
11915	#14 x 1-1/4"	Hex
11916	#14 x 1-1/2"	Hex

"6500" SERIES LARGE DRAWER "FIX-KITS"[®]



No. 6541 "Fix-Kit"
 U.S.S. Grade 5
 Cap Screws With Nuts
 Zinc Plated
 15 Varieties
 270 Screws - 270 Nuts

Auveco Part No.	Size
5434	1/4"-20 x 1/2"
5436	1/4"-20 x 3/4"
5438	1/4"-20 x 1"
5440	1/4"-20 x 1-1/2"
5449	5/16"-18 x 3/4"
5451	5/16"-18 x 1"
5453	5/16"-18 x 1-1/2"
5455	5/16"-18 x 2"
5465	3/8"-16 x 1"
5466	3/8"-16 x 1-1/4"
5467	3/8"-16 x 1-1/2"
5469	3/8"-16 x 2"
15586	1/4"-20 Hex Nut
15587	5/16"-18 Hex Nut
15588	3/8"-16 Hex Nut



No. 6514 "Fix-Kit"
 Metric Regular Pitch
 Cap Screws & Nuts
 DIN 931 & DIN 933
 Zinc Plated
 15 Varieties - 128 Pieces

Auveco Part No.	Size
14424	M8-1.25 x 40mm
14425	M8-1.25 x 45mm
14426	M8-1.25 x 50mm
14431	M10-1.50 x 25mm
14432	M10-1.50 x 30mm
14433	M10-1.50 x 35mm
14434	M10-1.50 x 40mm
14436	M10-1.50 x 50mm
14440	M12-1.75 x 25mm
14441	M12-1.75 x 30mm
14442	M12-1.75 x 35mm
14443	M12-1.75 x 40mm
14452	M8-1.25 Nut
14454	M10-1.50 Nut
14455	M12-1.75 Nut



No. 6540 "Fix-Kit"
 Metric Body Bolts & Nuts
 10 Varieties of Bolts
 5 Varieties of Extruded "U" Nuts
 3 Varieties of Free Spinning Washer Nuts
 2 Varieties of Hex Flange Nuts
 254 Pieces

Auveco Part No.	Size
12693	M6-1.0 x 20mm
12324	M6-1.0 x 20mm
12160	M6-1.0 x 22mm
12065	M6-1.0 x 25mm
12066	M6-1.0 x 25mm
12335	M6-1.0 x 28mm
17388	M8-1.25 x 20mm
13613	M8-1.25 x 25mm
13614	M8-1.25 x 30mm
11641	M10-1.50 x 40mm
11644	M8-1.25 Hex Flange Nut
11645	M10-1.5 Hex Flange Nut
12595	M6-1.0 Free Spin Wshr Nut
15329	M6-1.0 Free Spin Wshr Nut
15335	M8-1.25 Free Spin Wshr Nut
12669	M6-1.0 Extruded "U" Nut
12575	M6-1.0 Extruded "U" Nut
11630	M8-1.25 Extruded "U" Nut
11629	M8-1.25 Extruded "U" Nut
11631	M10-1.5 Extruded "U" Nut



No. 6513 "Fix-Kit"
 Metric Regular Pitch
 Cap Screws & Nuts
 DIN 933
 Zinc Plated
 16 Varieties - 236 Pieces

Auveco Part No.	Size
14400	M4-.7 x 16mm
14401	M4-.7 x 20mm
14402	M5-.8 x 10mm
14403	M5-.8 x 16mm
14404	M5-.8 x 20mm
14405	M5-.8 x 25mm
14408	M6-1.0 x 16mm
14409	M6-1.0 x 20mm
14410	M6-.10 x 25mm
14420	M8-1.25 x 20mm
14421	M8-1.25 x 25mm
14422	M8-1.25 x 30mm
14448	M4-.7 Nut
14449	M5-.8 Nut
14450	M6-1.0 Nut
14452	M8-1.25 Nut



No. 6532 "Fix-Kit"
 Stainless Steel Cap Screws,
 Nuts & Washers
 24 Varieties - 660 Pieces

Auveco Part No.	Size
13346	1/4"-20 x 1/2"
13347	1/4"-20 x 3/4"
13348	1/4"-20 x 1"
13349	1/4"-20 x 1-1/4"
13350	1/4"-20 x 1-1/2"
13352	1/4"-20 x 2"
13354	5/16"-18 x 3/4"
13355	5/16"-18 x 1"
13356	5/16"-18 x 1-1/4"
13357	5/16"-18 x 1-1/2"
13359	5/16"-18 x 2"
13364	3/8"-16 x 1"
13365	3/8"-16 x 1-1/4"
13366	3/8"-16 x 1-1/2"
13368	3/8"-16 x 2"
13234	1/4"-20 Hex Nut
13235	5/16"-18 Hex Nut
13236	3/8"-16 Hex Nut
13395	Bolt Size: 1/4" Flat Wshr
13396	Bolt Size: 5/16" Flat Wshr
13397	Bolt Size: 3/8" Flat Wshr
13403	Bolt Size: 1/4" Lock Wshr
13404	Bolt Size: 5/16" Lock Wshr
13405	Bolt Size: 3/8" Lock Wshr

Please Order In
 Unit Package
 Quantities
 Not Number Of
 Pieces



No. 6554 “Fix-Kit”

J.I.S. Hex Flange Bolts
& Spin Lock Nuts
21 Varieties, 322 Pieces

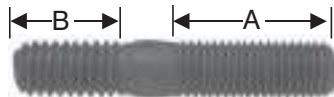

No. 6538 “Fix-Kit”

Cylinder Head & Manifold Studs
24 Varieties - 120 Pieces



No. 6524 “Fix-Kit”

Special Purpose
Well Nuts® & Jack Nuts®
(O.E.M. Application)
GM -Ford -Chrysler -AMC
12 Varieties - 170 Pieces

Auveco Part No.	Size
17315	M6-1.0 x 12mm
17316	M6-1.0 x 16mm
18807	M6-1.0 x 20mm
21048	M6-1.0 x 25mm
18808	M6-1.0 x 30mm
18809	M6-1.0 x 40mm
18980	M8-1.25 x 12mm
17387	M8-1.25 x 16mm
17388	M8-1.25 x 20mm
21051	M8-1.25 x 25mm
17389	M8-1.25 x 30mm
21052	M8-1.25 x 35mm
17390	M8-1.25 x 40mm
21053	M8-1.25 x 45mm
17188	M10-1.25 x 16mm
17189	M10-1.25 x 20mm
21054	M10-1.25 x 25mm
17190	M10-1.25 x 30mm
21055	M10-1.25 x 35mm
17191	M10-1.25 x 40mm
21056	M10-1.25 x 45mm
16769	M6-1.0 Nut
16830	M8-1.25 Nut
16470	M10-1.25 Nut

Auveco Part No.	Dimensions	
	A	B
9667	A: 1/4"-28 x 7/16"	B: 1/4"-20 x 7/16"
9669	A: 1/4"-28 x 3/4"	B: 1/4"-20 x 1/2"
9674	A: 5/16"-24 x 5/8"	B: 5/16"-18 x 1/2"
9675	A: 5/16"-24 x 5/8"	B: 5/16"-18 x 3/4"
9676	A: 5/16"-24 x 7/8"	B: 5/16"-18 x 9/16"
9677	A: 5/16"-24 x 1"	B: 5/16"-18 x 9/16"
9679	A: 5/16"-18 x 7/8"	B: 5/16"-18 x 7/16"
9683	A: 3/8"-24 x 3/4"	B: 3/8"-16 x 1/2"
9684	A: 3/8"-24 x 3/4"	B: 3/8"-16 x 1/2"
9686	A: 3/8"-24 x 1"	B: 3/8"-16 x 5/8"
9687	A: 3/8"-16 x 1-1/8"	B: 3/8"-16 x 5/8"
14827	A: 3/8"-16 x 1-1/2"	B: 3/8"-16 x 7/16"
9689	A: 3/8"-24 x 1"	B: 3/8"-16 x 3/4"
9690	A: 3/8"-24 x 2"	B: 3/8"-16 x 5/8"
9692	A: 3/8"-16 x 1-5/8"	B: 3/8"-16 x 7/16"
9701	A: 7/16"-20 x 7/8"	B: 7/16"-14 x 3/4"
9705	A: 7/16"-20 x 3/4"	B: 7/16"-14 x 3/4"
9711	A: 7/16"-14 x 1-1/4"	B: 7/16"-14 x 3/4"
9715	A: 7/16"-20 x 1-13/16"	B: 7/16"-14 x 3/4"
9728	A: 1/2"-20 x 15/16"	B: 1/2"-13 x 13/16"
9731	A: 1/2"-20 x 1"	B: 1/2"-13 x 3/4"
9732	A: 1/2"-20 x 2"	B: 1/2"-13 x 3/4"
11982	A: M8-1.25 x 22mm	B: M8-1.25 x 10mm
	40mm Overall	
11983	A: M8-1.25 x 22mm	B: M8-1.25 x 10mm
	45mm Overall	

Contains the following Auveco Part Numbers: **12995, 12999, 13004, 13007, 13008, 13009, 13010, 13014, 13016, 13017, 13231 & 16253**



No. 6502 “Fix-Kit”

Tubular, Flat, “U” & “J” Nuts
24 Varieties - 515 Pieces

Auveco Part No.	Size	
1903	1/4"-20	Flat
2089	#6-32	Flat
2092	#10-24	Flat
2099	1/8" Stud	Flat
2103	3/16" Stud	Flat
2105	1/4" Stud	Flat
2293	1/4"-20	“U”
2346	#8	“J”
2422	#10	“U”
2595	1/8" Stud	Tubular
2611	1/8" Stud	Tubular
5170	3/8"-16	“J” Cage
5197	#10-24	“U”
5586	1/4"-20	“J” Cage
5589	5/16"-18	“J” Cage
9879	#8	Spring “U”
9880	#8	Spring “U”
10064	#6	Spring “U”
10065	#8	Spring “U”
10066	#10	Spring “U”
10067	#14	Spring “U”
10666	#8	“U”
11292	#8	“U”
11429	#10	“U”

You Can Email
Your Suggestions
For New Assortments
To: mail@auveco.com

We Welcome All
Your Suggestions

"6500" SERIES LARGE DRAWER "FIX-KITS"[®]



No. 6507 "Fix-Kit"

Basic Internal & External Retaining Rings
Zinc Plated
24 Varieties - 1000 Pieces

Auveco Part No.	Shaft Diameter
-----------------	----------------

Internal Type

8688	1/4"
8689	5/16"
8690	3/8"
8691	7/16"
8692	1/2"
8693	9/16"
8694	5/8"
8695	3/4"
8696	7/8"
8697	1"
8698	1-1/8"
8699	1-1/4"

External Type

8701	1/4"
8702	5/16"
8703	3/8"
8704	7/16"
8705	1/2"
8706	9/16"
8707	5/8"
8708	3/4"
8709	7/8"
8710	1"
8711	1-1/8"
8712	1-1/4"



No. 6508 "Fix-Kit"

"E" & Reinforced "E" Rings
Groove Required
24 Varieties - 1500 Pieces

Auveco Part No.	Shaft Dia.	Type
8824	1/16"	E Type
8825	3/32"	E Type
8836	3/32"	Reinforced E
3165	1/8"	Reinforced E
8826	1/8"	E Type
3166	3/16"	Reinforced E
8827	3/16"	E Type
3167	1/4"	Reinforced E
8828	1/4"	E Type
3628	5/16"	Reinforced E
3824	5/16"	E Type
5600	3/8"	Reinforced E
8829	3/8"	E Type
2672	7/16"	Reinforced E
8830	7/16"	E Type
8837	1/2"	Reinforced E
5602	1/2"	E Type
5601	9/16"	Reinforced E
5603	5/8"	E Type
8831	3/4"	E Type
8832	7/8"	E Type
8833	1"	E Type
8834	1-3/16"	E Type
8835	1-3/8"	E Type

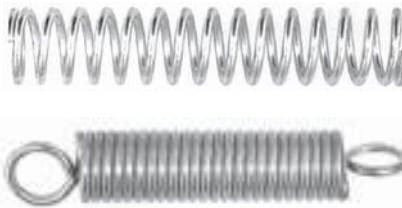

No. 6535 "Fix-Kit"

Extension & Compression Springs
12 Varieties - 94 Pieces

Auveco Part No.	Length
14074	1-1/4"
14072	1-7/16"
14096	2-1/2"
14070	2-21/32"
14063	3-1/4"
14064	4"
14067	4"
14066	4-1/16"
14065	4-1/2"
14068	5-1/4"
14059	6-7/16"
14060	6-1/2"



No. 6506 "Fix-Kit"

Hammer-lock Cotter Pins
Bright Zinc Chromate
16 Varieties - 1500 Pieces

Auveco Part No.	Size
-----------------	------

8477	1/16" x 1/2"
8478	1/16" x 3/4"
8479	1/16" x 1"
8480	1/16" x 1-1/2"
8481	3/32" x 3/4"
8482	3/32" x 1"
8484	3/32" x 1-1/2"
8485	3/32" x 2"
8486	1/8" x 1"
8487	1/8" x 1-1/4"
8488	1/8" x 1-1/2"
8490	1/8" x 2"
8491	1/8" x 2-1/2"
8492	5/32" x 1"
8493	5/32" x 1-1/2"
8494	5/32" x 2"



No. 6504 "Fix-Kit"

Woodruff Keys
1035 Carbon Steel
20 Varieties - 383 Pieces

Auveco Part No.	Size
-----------------	------

3877	1/8" x 1/2"	No. 3
3878	1/8" x 5/8"	No. 5
3879	1/8" x 3/4"	No. 7
3880	3/32" x 5/8"	No. 4
3881	5/32" x 5/8"	No. 6
3882	5/32" x 3/4"	No. 8
3883	5/32" x 7/8"	No. 10
3884	3/16" x 3/4"	No. 9
3885	3/16" x 7/8"	No. 11
3886	3/16" x 1"	No. 13
3887	3/16" x 1-1/8"	No. 16
3888	7/32" x 7/8"	No. 12
3889	7/32" x 1"	No. 14
3890	7/32" x 1-1/8"	No. 17
3891	1/4" x 7/8"	No. A
3892	1/4" x 1"	No. 15
3893	1/4" x 1-1/8"	No. 18
3894	1/4" x 1-1/4"	No. 21
3895	5/16" x 1"	No. B
3896	5/16" x 1-1/8"	No. C



No. 6510 “Fix-Kit”

Spring Pins
Zinc Plated

20 Varieties - 600 Pieces

Auveco
Part No.

Size

9013	5/32" x 1/2"
9015	5/32" x 3/4"
9016	5/32" x 1"
9017	5/32" x 1-1/4"
9018	5/32" x 1-1/2"
9019	3/16" x 1/2"
9021	3/16" x 3/4"
9022	3/16" x 1"
9023	3/16" x 1-1/4"
9024	3/16" x 1-1/2"
9025	3/16" x 1-3/4"
9026	3/16" x 2"
9030	1/4" x 5/8"
9031	1/4" x 3/4"
9033	1/4" x 1"
9034	1/4" x 1-1/4"
9035	1/4" x 1-1/2"
9036	1/4" x 1-3/4"
9037	1/4" x 2"
9038	1/4" x 2-1/4"



No. 6509 “Fix-Kit”

Spring Pins
Zinc Plated

24 Varieties - 1475 Pieces

Auveco
Part No.

Size

8981	1/16" x 3/16"
8983	1/16" x 1/2"
8985	1/16" x 3/4"
8987	1/16" x 1"
8988	5/64" x 1/4"
8989	5/64" x 1/2"
8991	5/64" x 3/4"
8992	5/64" x 1"
8993	5/64" x 1-1/4"
8994	5/64" x 1-1/2"
8995	3/32" x 5/16"
8996	3/32" x 1/2"
8998	3/32" x 3/4"
9000	3/32" x 1"
9001	3/32" x 1-1/4"
9002	3/32" x 1-1/2"
9003	1/8" x 3/8"
9004	1/8" x 1/2"
9006	1/8" x 3/4"
9008	1/8" x 1"
9009	1/8" x 1-1/4"
9010	1/8" x 1-1/2"
9011	1/8" x 1-3/4"
9012	1/8" x 2"



No. 6523 “Fix-Kit”

Nylon Connectors & Rubber Caps
24 Varieties - 320 Sizes

Auveco
Part No.

Size

Nylon Connectors		
12929	1/8" x 1/8"	Straight
12930	1/8" x 3/16"	Straight
12936	1/8" x 1/4"	Straight
12937	3/16" x 3/16"	Straight
12935	1/4" x 3/16"	Straight
12931	1/4" x 1/4"	Straight
12946	5/16" x 5/16"	Straight
12923	1/8" x 1/8" x 1/8"	Tee
12916	1/8" x 1/8" x 3/16"	Tee
12926	3/16" x 1/8" x 3/16"	Tee
12918	3/16" x 3/16" x 3/16"	Tee
12919	1/4" x 3/16" x 3/16"	Tee
11738	1/4" x 3/16" x 1/4"	Tee
12921	3/8" x 1/4" x 3/8"	Tee
12920	5/16" x 5/16" x 5/16"	Tee
12927	3/16" x 3/16" x 3/16"	"Y"
12943	1/4" x 1/4" x 1/4"	"Y"
12932	3/16" x 3/16"	Elbow
12939	3/16"	Cross

Rubber Caps

12209	For 1/8" O.D. Tube
4440	For 3/16" O.D. Tube
4439	For 1/4" O.D. Tube
12907	For 5/16" O.D. Tube
12210	For 3/8" O.D. Tube

Please Order In Unit
Package Quantities Not
Number Of Pieces



No. 6544 "Fix-Kit"

Krimp & Seal Terminals
Featuring 3 - 1 Ratio
Heat Shrink Tubing
24 Varieties - 204 Pieces

Auveco
Part No.

Description

13656	Ring Type, 22-18 Ga.
13657	Ring Type, 22-18 Ga.
13658	Spade Type, 22-18 Ga.
13659	Butt Conn., 22-18 Ga.
13660	Female Q.C., 22-18 Ga.
13661	Male Q.C., 22-18 Ga.
13662	Ring Type, 16-14 Ga.
13663	Ring Type, 16-14 Ga.
13664	Ring Type, 16-14 Ga.
13665	Ring Type, 16-14 Ga.
13666	Ring Type, 16-14 Ga.
13669	Butt Conn., 16-14 Ga.
13670	Female Q.C., 16-14 Ga.
13671	Male Q.C., 16-14 Ga.
13672	Female Q.C., 16-14 Ga.
13673	Male, Q.C., 16-14 Ga.
13674	Ring Type, 12-10 Ga.
13675	Ring Type, 12-10 Ga.
13676	Ring Type, 12-10 Ga.
13678	Butt Conn., 12-10 Ga.
13679	Female Q.C., 12-10 Ga.
13680	Male Q.C., 12-10 Ga.
13681	Female Plug, 16-14 Ga.
13682	Male Plug, 16-14 Ga.



No. 6543 "Fix-Kit"

O.E.M. Electrical Terminals & Tools
GM, Ford & Chrysler
24 Varieties - 263 Pieces

Contains the following Auveco Part
Numbers: 8774, 8776, 14150,
14151, 14152, 14462, 14880,
14881, 14883, 14884, 14885,
14892, 15497, 15498, 15499,
15504, 15937, 15948, 15955,
18324, 18325, 18326, 20583
& 20618

"6500" SERIES LARGE DRAWER "FIX-KITS"[®]

Sec. 15



No. 6558 "Fix-Kit"
Cable Ties & Straps
10 Varieties, 339 Pieces

Auveco
Part No. Size

8550	2-1/4" Long, 7/16" Wide
14298	148mm Long, 8mm Wide
15144	4" Long, 3/32" Wide
15145	5-1/2" Long, 1/8" Wide
15146	7" Long, 3/16" Wide
15147	11" Long, 3/16" Wide
15148	14" Long, 5/16" Wide
15753	14" Long, 3/16" Wide
20380	200mm Long, 5mm Wide
21203	155mm Long, 5mm Wide



No. 6553 "Fix-Kit"
Oil Drain Plugs & Gaskets
24 Varieties, 55 Pieces

Auveco
Part No. Size

14196	1/2"-20
18373	1/2"-20
19130	1/2"-20
19365	1/2"-20, Magnetic
15527	M12-1.25
19588	M12-1.25
14677	M12-1.75
18023	M12-1.75
18374	M12-1.75
20347	M12-1.75
21047	M12-1.75
18024	M14-1.25
14678	M14-1.5
16308	M14-1.5
18025	M14-1.5
18375	M14-1.5
19141	M14-1.5
19279	M14-1.5
19620	M14-1.5 Single Oversize
19773	M14-1.5
20426	M14-1.5
15528	M16.4-1.33
15529	M18-1.5
15530	M20-1.5



No. 6534 "Fix-Kit"
Oil Drain Plugs & Gaskets
12 Varieties - 86 Pieces

Auveco
Part No. Size

14196	1/2"-20
18373	1/2"-20
18121	1/2"-20 Double Oversize
15527	M12-1.25
14677	M12-1.75
18374	M12-1.75
21047	M12-1.75
14678	M14-1.5
16308	M14-1.5
19279	M14-1.5
19773	M14-1.5
15529	M18-1.5



No. 6511 "Fix-Kit"
Grease Fittings
12 Varieties - 145 Pieces

Auveco
Part No. Type

9257	1/4" - 28 Thread-Straight (Short)
9258	1/4" - 28 Thread-Straight (Long)
9259	1/4" - 28 Thread-Straight (Extra Long)
9260	1/4" - 28 Thread - 45°
9261	1/4" - 28 Thread - 90°
9262	1/8" Pipe Thread - Straight
9264	1/8" Pipe Thread - 45°
9265	1/8" Pipe Thread - 65°
9266	1/8" Pipe Thread - 90°
9267	1/8" Pipe Thread - Straight Extra Long
15060	3/16" Drive Fit - Straight
15066	1/8" Pipe Straight-Self-Tapping



No. 6525 "Fix-Kit"
Black Nylon Blind Rivets
16 Varieties - 400 Pieces

Auveco
Part No. Size

13746	3/16"; Grip: 1/16"-9/64"
13747	13/64"; Grip: 1/16"-11/64"
14005	13/64"; Grip: 1/8"-5/32"
13748	13/64"; Grip: 1/8"-15/64"
13755	13/64"; Grip: 15/64"-25/64"
14004	15/64"; Grip: 11/64"-11/32"
14023	15/64"; Grip: 5/32"-5/16"
18502	1/4"; Grip: 5/32"-1/4"
18108	1/4"; Grip: 5/32"-3/8"
13751	1/4"; Grip: 5/32"-13/32"
13750	1/4"; Grip: 5/32"-13/32"
15491	1/4"; Grip: 19/64"-27/64"
17101	1/4"; Grip: 5/16"-15/32"
13752	17/64"; Grip: 3/32"-3/16"
13753	17/64"; Grip: 3/32"-3/16"
15490	9/32"; Grip: 3/32"-15/64"



No. 6557 "Fix-Kit"
Metal Specialty Rivets
24 Varieties, 624 Pieces

Auveco
Part No. Size

1/8" (3.2mm) Diameter	
20788	Grip: 3/64" - 1/8"
20627	Grip: 3/64" - 3/16"
16834	Grip: 1/8" - 3/16"
8931	Grip: 3/16" - 1/4"
17615	Grip: 3/16" - 3/8"
5/32" (4mm) Diameter	
18461	Grip: 3/64" - 1/4"
20629	Grip: 3/64" - 1/4"
20971	Grip: 3/64" - 9/32"
19376	Grip: 1/8" - 11/32"
17006	Grip: 1/4" - 3/8"
3/16" (4.8mm) Diameter	
16864	Grip: 3/64" - 11/32"
20741	Grip: 3/64" - 23/64"
17121	Grip: 5/64" - 15/64"
8311	Grip: 1/8" - 1/4"
17410	Grip: 3/8" - 1/2"
14127	Grip: 3/8" - 1/2"
1/4" (6.4mm) Diameter	
16837	Grip: 1/32" - 9/64"
12653	Grip: 3/32" - 1/8"
18167	Grip: 3/32" - 9/64"
12652	Grip: 1/8" - 1/4"
12655	Grip: 9/64" - 3/16"
17639	Grip: 3/16" - 3/8"
8313	Grip: 1/4" - 3/8"
16838	Grip: 33/64" - 19/32"



No. 6505 “Fix-Kit”
 Rubber “O” Rings
 20 Varieties - 300 Pieces



No. 6522 “Fix-Kit”

“Xmas Tree” Retainers
 GM, Ford & Chrysler
 12 Varieties - 550 Pieces

Contains the following Auveco Part Numbers: **10831, 11146, 11796, 12137, 12565, 12737, 12766, 12909, 16818, 17339, 17612 & 17664.**



No. 6545 “Fix-Kit”
 GM Moulding Clips
 24 Varieties - 234 Pieces

Contains the following Auveco Part Numbers: **10617, 14642, 19757, 19800, 19820, 19821, 19822, 20280, 20318, 20328, 20353, 20377, 20607, 20756, 20774, 20808, 20865, 20884, 20934, 20952, 20972, 20976, 21128 & 21374**

Auveco Part No.	I.D.	O.D.
4305	1/8"	1/4"
4306	5/32"	9/32"
4307	3/16"	5/16"
4308	7/32"	11/32"
4309	1/4"	3/8"
4310	5/16"	7/16"
4311	3/8"	1/2"
4312	3/8"	9/16"
4313	7/16"	5/8"
4314	1/2"	11/16"
4315	9/16"	3/4"
4316	5/8"	13/16"
4317	11/16"	7/8"
4318	3/4"	15/16"
4319	3/4"	1"
4320	13/16"	1-1/16"
4321	7/8"	1-1/8"
4322	15/16"	1-3/16"
4323	1"	1-1/4"
4324	1-1/16"	1-5/16"



No. 6520 “Fix-Kit”

“Xmas Tree” Retainers
 Ford
 12 Varieties - 465 Pieces

Contains the following Auveco Part Numbers: **10831, 11136, 11146, 11351, 11671, 12565, 12571, 12909, 14757, 17339, 17664 & 20192.**



No. 6556 “Fix-Kit”
 BMW Clips & Fasteners
 14 Varieties, 416 Pieces

Auveco Part No.	Description
13158	Moulding Clip
13162	“U” Nut
13215	“U” Nut
13216	“U” Nut
13218	“U” Nut
13223	“U” Nut
18156	M4.8-1.59 x 16mm L.P. Screw
20186	Grommet
20234	Push-Type Retainer
20248	Push-Type Retainer
20253	Trim Panel Retainer
20270	Push-Type Retainer
20734	Push-Type Retainer
20754	Nylon Rivet



No. 6519 “Fix-Kit”
 “Xmas Tree” Retainers
 GM
 12 Varieties - 500 Pieces

Contains the following Auveco Part Numbers: **10621, 10831, 11146, 11678, 11796, 12137, 12731, 12737, 12766, 15970, 16818 & 17664.**



No. 6517 “Fix-Kit”

Nylon Nuts
 16 Varieties - 850 Pieces

Contains the following Auveco Part Numbers: **2625, 3682, 5228, 8435, 9829, 9851, 9862, 10330, 11368, 11691, 11719, 11838, 11855, 13450, 13933 & 18816.**



No. 6542 “Fix-Kit”

GM, Ford & Chrysler
Push-Type Retainers
11 Varieties - 325 Pieces

Contains the following Auveco Part Numbers: **20826, 20880, 20888, 20889, 20988, 20989, 20990, 20991, 20992, 20993 & 20994.**



No. 6548 “Fix-Kit”

Honda & Acura
Retainers & Retaining Clips
24 Varieties, 404 Pieces

Contains the following Auveco part numbers:
14289, 14291, 14328, 15998, 16775, 16776, 16779, 17205, 18114, 18294, 18746, 18877, 19114, 19116, 19145, 19171, 19470, 19506, 19682, 20334, 20609, 20610, 20882 & 21107



No. 6549 “Fix-Kit”

Honda & Acura
Push-Type Retainers
24 Varieties, 254 Pieces

Contains the following Auveco part numbers:
14696, 14697, 16000, 16782, 17057, 17143, 17144, 17267, 17379, 18119, 19118, 19140, 19231, 19233, 19239, 19416, 19453, 20247, 20352, 20564, 20608, 20986, 21173 & 21297



No. 6537 “Fix-Kit”

Door Hinge Pins & Bushings
16 Varieties - 221 Pieces

Bushings

14548, 14549, 14550, 14551, 14552, 14553, 16936, 16937, 17167 & 17434.

Pins

14559, 17343, 17437, 19183, 19424 & 19781



No. 6546 “Fix-Kit”

Hyundai & Kia Clips & Fasteners
20 Varieties - 375 Pieces

Auveco Part No.	Description
-----------------	-------------

- | | |
|-------|-----------------------------|
| 20543 | Hood Insulation Retainer |
| 20566 | Moulding Clip |
| 20567 | Moulding Clip |
| 20568 | Moulding Clip |
| 20680 | M6-1.0 L.P. Screw |
| 21064 | Moulding Clip |
| 21067 | Bumper & Grille Retainer |
| 21068 | Nylon Nut |
| 21070 | Trim Panel Retainer |
| 21136 | Moulding Clip |
| 21146 | Push-Type Retainer |
| 21188 | Trim Panel Retainer |
| 21244 | Moulding Clip |
| 21312 | Moulding Clip |
| 21321 | Moulding Clip |
| 21328 | Push-Type Retainer |
| 21360 | Trim Panel Retainer |
| 21378 | Nylon “U” Nut |
| 21381 | Hood Seal Retainer |
| 21382 | Cowl Vent & Grille Retainer |



No. 6555 “Fix-Kit”

Mercedes-Benz
Clips & Fasteners
24 Varieties, 488 Pieces

Auveco Part No.	Description
-----------------	-------------

- | | |
|-------|----------------------|
| 13215 | “U” Nut |
| 13216 | “U” Nut |
| 13218 | “U” Nut |
| 13220 | “U” Nut |
| 13223 | “U” Nut |
| 13224 | “U” Nut |
| 13230 | Push-Type Retainer |
| 16124 | Tubular Type Nut |
| 20187 | Push-Type Retainer |
| 20188 | Trim Panel Retainer |
| 20203 | Push-Type Retainer |
| 20205 | Moulding Insert |
| 20314 | Push-Type Retainer |
| 20636 | Push-Type Retainer |
| 20637 | Push-Type Retainer |
| 20638 | Push-Type Retainer |
| 20642 | Door Panel Ret. Clip |
| 20645 | Carpet Retainer |
| 20650 | “U” Nut |
| 20735 | Door Panel Retainer |
| 20897 | Moulding Clip |
| 20909 | Push-Type Retainer |
| 20971 | Rivet |
| 21105 | Hood Ins. Retainer |



No. 6550 “Fix-Kit”

Nissan & Infiniti
Retainers & Push-Type Retainers
24 Varieties, 369 Pieces

Contains the following Auveco part numbers:
14355, 14696, 14737, 16000, 16776, 16782, 16784, 16858, 16859, 17237, 17347, 17452, 17472, 18166, 18948, 19246, 19274, 19684, 20327, 20348, 20349, 20672, 20953 & 21192

**“Fix-Kit”
Lid Labels
Are Available For
Updating Assortments.
Refer To Page 279.**

Sec. 15 "6500" SERIES LARGE DRAWER "FIX-KITS"[®]



No. 6551 "Fix-Kit"

Toyota & Lexus
Retainers & Retaining Clips
24 Varieties, 360 Pieces

Contains the following
Auveco part numbers:
14269, 14736, 14737, 14738,
15709, 18297, 18692, 18842,
18844, 18876, 18878, 19112,
19113, 19210, 19257, 19729,
19749, 19842, 20437, 20443,
20633, 20757, 20758 & 21102

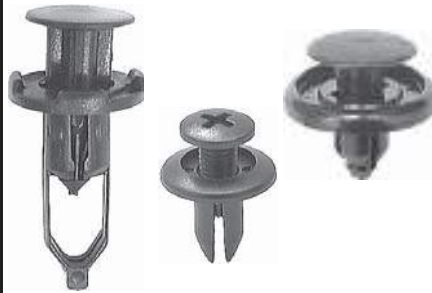

No. 6552 "Fix-Kit"

Toyota & Lexus
Push-Type Retainers
24 Varieties, 229 Pieces

Contains the following
Auveco part numbers:
14260, 16784, 17162, 17439,
18270, 18873, 18888, 19140,
19416, 19552, 19739, 20335,
20349, 20577, 20869, 20908,
20931, 20955, 21010, 21011,
21103, 21123, 21201 & 21294



No. 6547 "Fix-Kit"

Volkswagen & Audi
Clips & Fasteners
24 Varieties – 385 Pieces

Auveco Part No.	Description
13173	Door Panel Clip
13475	Trim Panel Retainer
17006	Moulding Rivet
19195	Push-Type Retainer
20341	Trim Panel Retainer
20924	Screw Grommet
20925	Screw Grommet
21144	Trim Panel Retainer
21145	Hood Insulation Retainer
21251	Push-Type Retainer
21392	Cowl Vent & Grille Retainer
21393	Trim Retainer
21394	Moulding Clip
21395	Moulding Clip
21396	Moulding Clip
21397	Moulding Clip Grommet
21398	Trim Panel Retainer
21399	Screw Grommet
21449	Moulding Clip
21478	Moulding Clip
21479	Push-Type Retainer
21512	Moulding Clip
21513	Push-On Retainer
21515	Fender & Bumper Retainer



Take The Guesswork Out Of Identifying Clips and Fasteners With Auveco Display Boards

To assist you in correctly identifying body hardware, we have the most popular items shrink-wrapped onto seven convenient, time-saving 11" wide by 14" long product display boards. The display boards show the Auveco part numbers, the O.E.M. numbers, sizes, descriptions, etc. It's all the information you need to make sure you're selling the correct part.

Refer to the color pages at the front of the catalog for all the information on the Auveco Display Board program.

"6900" SERIES QUIK-SELECT II ASSORTMENTS

QUIK-SELECT II BOXES



Translucent Durable Polypropylene Boxes
With Locking Tabs
13-1/16" Wide x 8-13/16" Deep x 2-1/4" High

- 12 Compartment Box**
69-12 UNIT PACKAGE: 1
69-112 UNIT PACKAGE: 10
- 18 Compartment Box**
69-18 UNIT PACKAGE: 1
69-118 UNIT PACKAGE: 10
- 24 Compartment Box**
69-24 UNIT PACKAGE: 1
69-124 UNIT PACKAGE: 10



QUIK - SELECT II RACK 69-RACK

Empty Cabinet. Will hold 5 Quik-Select II Assortments.
13-1/2" Wide x 9-1/8" Deep x 13-1/4" High
Finish: Gray Enamel
Keyhole slots are furnished for wall mounting.
A handle is provided and bolt holes permits stacking.
UNIT PACKAGE: 1



QUIK-SELECT II

**A Great Marketing Concept
For New or Existing Accounts**

If you're looking for more variety of coverage and want to be sure that there is enough product to finish the job, Quik-Select II is your answer.

Take the step up in body hardware coverage with Auveco's Quik-Select II assortments. Quik-Select II's feature a polypropylene box that's larger (13-1/16" Wide x 8-13/16" Deep x 2-1/4" High) than our 6800 series Quik-Select assortments, and thus not only provide a larger variety of parts in each assortment but they also contain a greater number of each part per compartment.

The assortments come in 12, 18 and 24 compartment, translucent, durable polypropylene boxes with lid labels complete with O.E.M. numbers, sizes, product pictures, code 128 barcodes and the Auveco part numbers for ordering refills.

Auveco Part No.	Description	Auveco Part No.	Description	Auveco Part No.	Description
6901	GM Retainers	6913	Toyota & Lexus Push-Type Retainers	6924	Washer Lock Nuts, Thread Cutting Nuts, Push-On & Pushnut Retainers
6902	Ford Retainers	6914	Honda & Acura Push-Type Retainers	6929	Rubber & Vinyl Vacuum Caps
6903	Chrysler Retainers	6915	Nissan & Infiniti Push-Type Retainers	6930	Nylon Connectors
6904	GM Push-Type Retainers	6916	Toyota & Lexus Nylon Nuts & Screw Grommets	6931	Oil Drain Plug Gaskets
6905	Ford Push-Type Retainers	6917	Honda & Acura Nylon Nuts & Screw Grommets	6933	Rubber Grommets
6906	Chrysler Push-Type Retainers	6919	GM, Ford & Chrysler Push-Type Retainers	6934	Door Lock Rod Clips
6907	GM Nylon Nuts	6920	Black Tapping Screws	6935	BMW Clips & Fasteners
6908	Ford Nylon Nuts	6921	Teks® Screws	6936	Mercedes-Benz Clips & Fasteners
6910	Toyota & Lexus Retainers & Retaining Clips	6923	Extruded "U" Nuts	6937	Hyundai & Kia Clips & Fasteners

Sec. 15 "6900" SERIES QUIK-SELECT II ASSORTMENTS



No. 6920

Black Tapping Screws
24 Varieties - 490 Pieces

Auveco
Part No. Size

Black Oxide Phillips Oval Head

12897	#4 x 1"
12796	#6 x 3/4"
10162	#8 x 1/2" w/ #6 HD
10164	#8 x 3/4" w/ #6 HD
10165	#8 x 3/4"
10166	#8 x 1" w/ #6 HD
10167	#8 x 1"

Black Oxide Phillips Pan Head

11917	#6 x 1/2"
10180	#8 x 1/2"
10181	#8 x 3/4"
10182	#8 x 1"
12799	#8 x 1-1/2"
11921	#10 x 1/2"
11922	#10 x 3/4"
11923	#10 x 1"

Black E-Coat Phillips Flat Washer Head

12213	#8 x 1/2"
12214	#8 x 5/8"
12215	#8 x 3/4"
12216	#8 x 1"
12217	#8 x 1-1/4"
12218	#8 x 1-1/2"
12953	#10 x 3/4"
12954	#10 x 1"

Black Phos. Phillips Pan Head Sems®

12820	#8 x 3/4"
-------	-----------



No. 6923

Extruded "U" Nuts
18 Varieties - 125 Pieces

Auveco
Part No. Size

10048	#8-32	3/8" Hole/Edge
15677	#10-24	15/32" Hole/Edge
8359	1/4"-20	17/32" Hole/Edge
10051	1/4"-20	25/32" Hole/Edge
10053	5/16"-18	9/16" Hole/Edge
8814	5/16"-18	27/32" Hole/Edge
10054	3/8"-16	3/4" Hole/Edge
10055	3/8"-16	1-1/8" Hole/Edge
11625	M4-.7	13.5mm Hole/Edge
11626	M5-.8	15.8mm Hole/Edge
16846	M6-1.0	12mm Hole/Edge
16842	M6-1.0	13.5mm Hole/Edge
12669	M6-1.0	13.5mm Hole/Edge
12575	M6-1.0	19.5mm Hole/Edge
11628	M6.3-1.0	13.5mm Hole/Edge
11629	M8-1.25	14.5mm Hole/Edge
11630	M8-1.25	20mm Hole/Edge
11631	M10-1.5	19mm Hole/Edge



No. 6921

Teks® Screws
18 Varieties - 520 Pieces

Auveco
Part No. Size

Phillips Pan Head

9605	#8 x 1/2"
9606	#8 x 3/4"
9608	#10 x 3/4"

Hex Washer Head

9611	#8 x 1/2"
9612	#8 x 3/4"
9613	#10 x 1/2"
9615	#10 x 3/4"
9616	#10 x 1"
11911	#12 x 1"
11914	#14 x 1"

Specialty Screws

12095	#8 x 1/2"
15172	#8 x 1/2"
15774	#8 x 1/2"
17460	#8 x 3/4"
17650	#8 x 3/4"
18261	M4.2-1.41 x 16mm
15775	M4.2-1.41 x 20mm
19006	M4.2-1.41 x 25mm



No. 6929

Vacuum Caps
12 Varieties - 332 Pieces

Auveco
Part No. Size

Rubber Vacuum Caps

12209	Fits 1/8"	O.D. Tube
4440	Fits 3/16"	O.D. Tube
4439	Fits 1/4"	O.D. Tube
19001	Fits 1/4"	O.D. Tube
12907	Fits 5/16"	O.D. Tube
19002	Fits 5/16"	O.D. Tube
12210	Fits 3/8"	O.D. Tube
12908	Fits 1/2"	O.D. Tube

Vinyl Vacuum Caps

18202	Fits 3/16"	O.D. Tube
18203	Fits 1/4"	O.D. Tube
18204	Fits 5/16"	O.D. Tube
18205	Fits 3/8"	O.D. Tube



No. 6924

Washer Lock Nuts,
Thread Cutting Nuts,
Push-On Retainers &
Pushnut Bolt Retainers
24 Varieties - 489 Pieces

Auveco
Part No. Size

Thread Cutting Nuts

12253	5mm Stud Size
3403	1/8" Stud Size
3404	3/16" Stud Size
2896	3/16" Stud Size
2897	1/4" Stud Size
3405	1/4" Stud Size
10733	5/16" Stud Size

Washer Lock Nuts

2557	#10-24	1/2 OD
2558	#10-24	3/4 OD

Push-On Retainers

8863	1/8" Stud Size
8864	5/32" Stud Size
8865	3/16" Stud Size
8868	1/4" Stud Size
8869	5/16" Stud Size
10374	3/8" Stud Size

Pushnut Bolt Retainers

10086	1/4" Bolt Size
10087	5/16" Bolt Size
9297	3/8" Bolt Size
9299	1/2" Bolt Size
12122	M5-.8 Bolt Size
12123	M6-1.0 Bolt Size
12125	M8-1.25 Bolt Size
12127	M12-1.75 Bolt Size
14980	M14-2.0 Bolt Size

You Can Email
Your Suggestions
For New Assortments
To: mail@auveco.com.

We Welcome All
Your Suggestions

"6900" SERIES QUIK-SELECT II ASSORTMENTS

Sec. 15



No. 6930

Nylon Connectors
24 Varieties - 215 Pieces

Auveco Part No.	Size	
10101	1/8" x 1/8"	Straight
12929	1/8" x 1/8"	Straight
12930	1/8" x 3/16"	Straight
12936	1/8" x 1/4"	Straight
10102	3/16" x 3/16"	Straight
12937	3/16" x 3/16"	Straight
10103	1/4" x 1/4"	Straight
12935	3/16" x 1/4"	Straight
12931	1/4" x 1/4"	Straight
10104	5/16" x 5/16"	Straight
12946	5/16" x 5/16"	Straight
10105	3/8" x 3/8"	Straight
12923	1/8" x 1/8" x 1/8"	Tee
10108	5/32" x 5/32" x 5/32"	Tee
12926	3/16" x 1/8" x 3/16"	Tee
10109	3/16" x 3/16" x 3/16"	Tee
12918	3/16" x 3/16" x 3/16"	Tee
12919	1/4" x 3/16" x 3/16"	Tee
10110	1/4" x 1/4" x 1/4"	Tee
12921	3/8" x 1/4" x 3/8"	Tee
12920	5/16" x 5/16" x 5/16"	Tee
11228	3/8" x 3/8" x 3/8"	Tee
12927	3/16" x 3/16" x 3/16"	Y
12932	3/16" x 3/16"	Elbow



No. 6931

Oil Drain Plug Gaskets
18 Varieties - 153 Pieces

Auveco Part No.	Size	
8277	1/2"	Nylon
15918	1/2"	Copper
15919	9/16"	Copper
16026	1/2"	Steel & Rubber
16682	14mm	Black Fibre
16955	18mm	Aluminum
16956	14mm	Aluminum
16996	1/2"	Nylon
17261	12mm	Copper
17262	14mm	Copper
17264	18mm	Copper
17265	20mm	Copper
17628	12mm	Green Fibre
18299	14mm	Steel & Rubber
18665	11mm	Rubber
18726	12mm	Black Fibre
19630	11mm	Rubber
20453	13mm	Rubber



No. 6933

Rubber Grommets
24 Varieties - 252 Pieces

Auveco Part No.	Size	
4408	1/8" Bore Dia, 3/32" Width	
4410	5/32" Bore Dia, 1/16" Width	
4413	3/16" Bore Dia, 1/16" Width	
4414	3/16" Bore Dia, 3/32" Width	
4415	3/16" Bore Dia, 1/4" Width	
16454	1/4" Bore Dia, 1/16" Width	
4417	1/4" Bore Dia, 1/16" Width	
4419	5/16" Bore Dia, 1/16" Width	
4420	5/16" Bore Dia, 1/16" Width	
4421	5/16" Bore Dia, 1/8" Width	
4422	5/16" Bore Dia, 1/4" Width	
4423	3/8" Bore Dia, 1/16" Width	
16456	3/8" Bore Dia, 1/16" Width	
4425	3/8" Bore Dia, 1/16" Width	
4426	3/8" Bore Dia, 1/4" Width	
4428	1/2" Bore Dia, 3/32" Width	
4429	1/2" Bore Dia, 3/32" Width	
16458	1/2" Bore Dia, 1/8" Width	
4430	1/2" Bore Dia, 1/4" Width	
4431	5/8" Bore Dia, 1/8" Width	
4432	5/8" Bore Dia, 1/16" Width	
4433	3/4" Bore Dia, 1/16" Width	
4434	3/4" Bore Dia, 1/16" Width	
4436	3/4" Bore Dia, 1/4" Width	



No. 6901

GM Retainers
18 Varieties - 373 Pieces

Contains the following Auveco part numbers: 10831, 11130, 11146, 11612, 11796, 12137, 12731, 12737, 12759, 12766, 12992, 14036, 15456, 15543, 15970, 16818, 17664 & 17975.

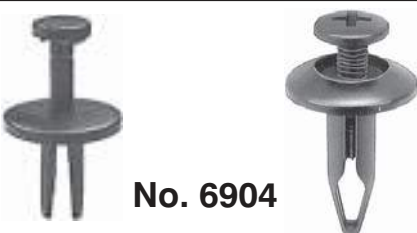

No. 6904

GM Push-Type Retainers
18 Varieties - 233 Pieces

Contains the following Auveco part numbers: 12567, 12757, 13993, 13994, 13996, 14010, 14011, 14020, 14753, 14997, 15044, 16622, 16835, 17216, 17222, 18353, 19639 & 19801.

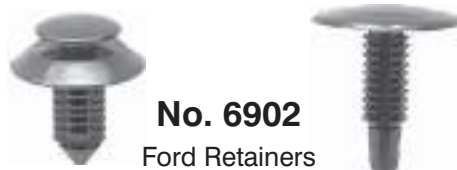

No. 6902

Ford Retainers
18 Varieties - 350 Pieces

Contains the following Auveco part numbers: 10831, 11136, 11146, 11351, 11612, 11671, 12565, 12571, 12909, 13470, 14021, 14163, 15479, 17339, 17612, 17664, 19655 & 20192.



No. 6903

Chrysler Retainers
18 Varieties - 338 Pieces

Contains the following Auveco part numbers: 10831, 11129, 11136, 11146, 11351, 11678, 14921, 15481, 15543, 16818, 17004, 17612, 17664, 17975, 18033, 18862, 18915 & 19386.



No. 6905

Ford Push-Type Retainers
12 Varieties - 219 Pieces

Contains the following Auveco part numbers: 13994, 14018, 14019, 14020, 14753, 14953, 14991, 14992, 14994, 17103, 17216 & 18894.



No. 6906

Chrysler Push-Type Retainers
12 Varieties - 205 Pieces

Contains the following Auveco part numbers: 11699, 11704, 12567, 13993, 14016, 14019, 14992, 16835, 17216, 18030, 18269 & 19422.

Sec. 15 "6900" SERIES QUIK-SELECT II ASSORTMENTS



No. 6919

GM, Ford & Chrysler
Push-Type Retainers
11 Varieties - 215 Pieces

Contains the following Auveco
part numbers: **20826, 20880,
20888, 20889, 20988, 20989,
20990, 20991, 20992, 20993
& 20994**



6934

Door Lock Rod Clips
18 Varieties - 152 Pieces

Contains the following Auveco
part numbers: **10262, 14359,
14365, 14967, 15518, 15673,
15674, 15675, 15759, 17122,
18392, 18393, 18926, 19658,
20469, 20470, 20534 & 20535**



No. 6914

Honda & Acura
Push-Type Retainers
18 Varieties - 163 Pieces

Contains the following Auveco
part numbers: **14696, 14697,
14698, 16000, 16782, 17057,
17143, 17144, 17267, 17379,
18119, 19118, 19140, 19233,
19239, 19453, 20247 & 20564**



No. 6907

GM Nylon Nuts
12 Varieties - 480 Pieces

Contains the following Auveco
part numbers: **3682, 8435,
9829, 11424, 11691, 11719,
11838, 12735, 13450, 13933,
13960 & 14031.**



No. 6935

BMW Clips & Fasteners
12 Varieties - 212 Pieces

Auveco Part No.	Description
13158	Moulding Clip
13162	"U" Nut
13215	"U" Nut
13218	"U" Nut
13223	"U" Nut
18156	License Plate Screw M4.8 X 16mm
20234	Nylon Rivet
20248	Push -Type Retainer
20253	Trim Panel Retainer
20270	Push -Type Retainer
20734	Push -Type Retainer
20754	Nylon Rivet



No. 6917

Honda & Acura
Nylon Nuts & Screw Grommets
12 Varieties - 224 Pieces

Contains the following Auveco
part numbers: **14255, 14268,
14274, 14281, 14288, 14313,
14695, 17058, 18415, 19454,
19734 & 19741.**



No. 6908

Ford Nylon Nuts
12 Varieties - 310 Pieces

Contains the following Auveco
part numbers: **9862, 11368,
11841, 12569, 14754, 14755,
14756, 18816, 19277, 19326,
19783 & 20245.**



No. 6911

Honda & Acura
Retainers & Retaining Clips
24 Varieties - 334 Pieces

Contains the following Auveco
part numbers: **14282, 14289,
14291, 14328, 15998, 16775,
16776, 16779, 17205, 18114,
18294, 18746, 18818, 18877,
19114, 19116, 19145, 19171,
19470, 19483, 19506, 19682,
20334 & 20609.**



No. 6937

Hyundai & Kia
Clips & Fasteners
18 Varieties - 113 Pieces

Auveco Part No.	Description
20543	Hood Insulation Retainer
20566	Moulding Clip
20567	Moulding Clip
20568	Moulding Clip
20680	M6-1.0 L. P. Screw
21064	Moulding Clip
21067	Bumper & Grille Retainer
21068	Nylon Nut
21070	Trim Panel Retainer
21136	Moulding Clip
21146	Push-Type Retainer
21188	Trim Panel Retainer
21244	Moulding Clip
21312	Moulding Clip
21321	Moulding Clip
21328	Push-Type Retainer
21378	Nylon "U" Nut
21382	Cowl Vent & Grille Retainer

"6900" SERIES QUIK-SELECT II ASSORTMENTS **Sec. 15**



No. 6936

Mercedes-Benz
Clips & Fasteners
24 Varieties - 106 Pieces

Auveco
Part No. Description

13215	"U" Nut
13216	"U" Nut
13218	"U" Nut
13220	"U" Nut
13223	"U" Nut
13224	"U" Nut
13230	Push-Type Retainer
16124	Tubular Type Nut
20187	Push-Type Retainer
20188	Trim Panel Retainer
20203	Push-Type Retainer
20205	Moulding Insert
20314	Push-Type Retainer
20636	Push-Type Retainer
20637	Push-Type Retainer
20638	Push-Type Retainer
20642	Door Panel Ret. Clip
20645	Carpet Retainer
20650	"U" Nut
20735	Door Panel Retainer
20897	Moulding Clip
20909	Push-Type Retainer
20971	Rivet
21105	Hood Ins. Retainer



No. 6912

Nissan & Infiniti
Retainers & Retaining Clips
12 Varieties - 335 Pieces

Contains the following Auveco part numbers: 14349, 14352, 14353, 14355, 14356, 14723, 14737, 16775, 16776, 17237, 17452 & 18166.



No. 6915

Nissan & Infiniti
Push-Type Retainers
18 Varieties - 179 Pieces

Contains the following Auveco part numbers: 14696, 14727, 16000, 16725, 16782, 16783, 16784, 16843, 16858, 16859, 17347, 17472, 18265, 19246, 19274, 20327, 20348 & 20349.



No. 6913

Toyota & Lexus
Push-Type Retainers
18 Varieties - 149 Pieces

Contains the following Auveco part numbers: 14260, 16784, 17162, 17206, 17439, 17988, 17992, 18270, 18873, 18888, 18939, 19013, 19128, 19140, 19219, 19416, 19739 & 20335.



No. 6916

Toyota & Lexus
Nylon Nuts & Screw Grommets
18 Varieties - 230 Pieces

Contains the following Auveco part numbers: 13932, 14256, 14258, 14265, 14267, 14268, 14271, 14273, 14274, 14275, 14277, 14281, 14695, 19194, 19721, 19756, 19783 & 20440.



No. 6910

Toyota & Lexus
Retainers & Retaining Clips
24 Varieties - 280 Pieces

Contains the following Auveco part numbers: 14144, 14269, 14270, 14736, 14737, 14738, 15707, 15709, 16779, 18297, 18692, 18842, 18844, 18876, 18878, 19112, 19113, 19124, 19210, 19257, 19729, 19749, 19842 & 20443.

Don't see the Assortment you want?

Even though we offer over 100 Quik-Select and Quik-Select II Assortments, we know you have some great ideas for new ones. We welcome all your suggestions.

Because many of our most popular assortments were created based on customer recommendations, we want to know what you want.

E-mail your new assortment suggestions to mail@auveco.com



Translucent Durable Polypropylene Boxes
With Locking Tabs
6-3/4" x 11" x 1-3/4"

6 Compartment Box

68-6 UNIT PACKAGE: 1
68-106 UNIT PACKAGE: 10

12 Compartment Box

68-12 UNIT PACKAGE: 1
68-112 UNIT PACKAGE: 10

18 Compartment Box

68-18 UNIT PACKAGE: 1
68-118 UNIT PACKAGE: 10



68-RACK

Empty Cabinet. Will Hold 5 Quik-Select Kits.
11-1/4" Wide x 6-3/4" Deep x 10-3/4" High
Finish: Gray Enamel
Keyhole slots are furnished for wall mounting.
A handle is provided and bolt holes permit stacking.



Fast moving body hardware and specialty fasteners in convenient, translucent, durable polypropylene boxes. Our Quik-Select Assortments offer popular coverage in an economical package that makes choosing the correct part fast and easy. Assortments come in 6, 12 and 18 compartment layouts complete with O.E.M. numbers, sizes, specifications and the proper Auveco part number for ordering refills.

Quik-Select Assortments Numeric Listing

Auveco Part No.	Description	Auveco Part No.	Description	Auveco Part No.	Description
6801	GM "Xmas Tree" Retainers	6826	Rubber Vacuum Caps	6852	Stainless Steel Tapping Screws
6802	Ford "Xmas Tree" Retainers	6827	Rubber Grommets	6853	Specialty Screws
6803	Chrysler "Xmas Tree" Retainers	6829	Honda Body Hardware	6854	Metric Specialty Screws
6804	GM Push-Type Retainers	6830	Hair Pin Cotter	6856	External & Internal Lock Washers
6805	Ford Push-Type Retainers	6831	Plastic Plug Buttons	6857	Thread Cutting & Washer Lock Nuts
6806	Nylon Rivets	6834	Toyota Body Hardware	6858	Pushnut Bolt Retainers
6807	Nylon Nuts	6835	Rubber "O" Rings	6859	Hose Connectors
6808	License Plate Hardware	6836	Nylon Connectors	6861	Spring Pins
6809	Window Reveal Moulding Clips	6837	Honda Body Hardware	6862	"E" Type Retaining Rings
6810	Sems® Screws	6838	Nissan Body Hardware	6863	External & Internal Retaining Rings
6811	Specialty Screws	6839	Toyota Body Hardware	6864	Door Lock Rod Clips
6812	Black Tapping Screws	6840	Pan'l Blind Rivets	6865	Weatherstrip Retainers
6813	Teks® Screws	6841	Specialty Rivets	6866	Rubber Bumpers
6814	Body Bolts	6842	Nylon Insulated Terminals	6867	Wire Loom Clips
6815	Tubular, Flat, "U" & "J" Nuts	6843	Vinyl Insulated Terminals	6868	Shims
6816	Extruded "U" Nuts	6845	GM "Xmas Tree" Retainers	6869	Fender Washers
6817	Washer Type Nuts & Push-On Retainers	6846	Ford "Xmas Tree" Retainers	6870	GM, Ford & Chrysler Push-Type Retainers
6818	Cotter Pins	6847	Chrysler "Xmas Tree" Retainers	6871	Hyundai & Kia Clips & Fasteners
6820	Oil Drain Plug Gaskets	6848	Chrome Phillips Oval Head Tapping Screws		
6821	Glass Shop Rivets	6850	Black Phillips Oval Head Tapping Screws		
6822	GM Window Guides				
6825	Oil Drain Plug Gaskets	6851	Zinc & Black Phillips Pan Head Tapping Screws		

"6800" SERIES QUIK-SELECT ASSORTMENTS

Sec. 15



No. 6848

Phillips Oval Head
Tapping Screws
Chrome Plated
18 Varieties - 200 Pieces

Auveco Part No.	Size
2698	#6 x 1/2"
1794	#6 x 3/4"
1796	#6 x 1"
2707	#8 x 1/2"
2027	#8 x 1-1/4" w/ #6 Head
2710	#8 x 3/4"
1799	#8 x 3/4" w/ #6 Head
2713	#8 x 1"
1483	#8 x 1" w/ #6 Head
2716	#8 x 1-1/4"
1423	#8 x 1-1/4" w/ #6 Head
2718	#8 x 1-1/2"
1932	#8 x 1-1/2" w/ #6 Head
1933	#8 x 1-3/4" w/ #6 Head
2728	#10 x 3/4"
1717	#10 x 3/4" w/ #8 Head
2731	#10 x 1"
2730	#10 x 1" w/ #8 Head



No. 6850

Phillips Oval Head
Tapping Screws
Black Oxide Plated
18 Varieties - 339 Pieces

Auveco Part No.	Size
12795	#6 x 1/2"
12796	#6 x 3/4"
12797	#6 x 1"
10163	#8 x 1/2"
10162	#8 x 1/2" w/ #6 Head
10165	#8 x 3/4"
10164	#8 x 3/4" w/ #6 Head
10167	#8 x 1"
10166	#8 x 1" w/ #6 Head
10169	#8 x 1-1/4"
10168	#8 x 1-1/4" w/ #6 Head
10171	#8 x 1-1/2"
10170	#8 x 1-1/2" w/ #6 Head
11086	#10 x 3/4"
11087	#10 x 3/4" w/ #8 Head
11088	#10 x 1"
11089	#10 x 1" w/ #8 Head
11092	#10 x 1-1/2"



No. 6810

Sems® Screws
Plated
18 Varieties - 140 Pieces

Auveco Part No.	Size
Chrome	
3538	#6 x 3/4"
2771	#8 x 5/8" w/#6 Hd.
2751	#8 x 3/4" w/#6 Hd.
11450	#8 x 3/4", Tek
2775	#8 x 7/8" w/#6 Hd., w/Flush Washer
2772	#8 x 1" w/#6 Hd.
2773	#8 x 1-1/4" w/#6 Hd.
3465	#10 x 5/8" w/#8 Hd.
3466	#10 x 3/4" w/#8 Hd.
3467	#10 x 1" w/#8 Hd.
Black	
11787	#8 x 5/8" w/#6 Hd.
11454	#8 x 5/8", Tek
11788	#8 x 3/4" w/#6 Hd.
11455	#8 x 3/4", Tek
11789	#8 x 1" w/ #6 Hd.
12957	#8 x 1" w/#6 Hd. w/ Flush Washer
11791	#10 x 3/4" w/#8 Hd.
11792	#10 x 1" w/#8 Hd.



No. 6812

Black
Tapping Screws
18 Varieties - 312 Pieces

Auveco Part No.	Size
Black E Coat Phillips Flat Washer Head	
12213	#8 x 1/2"
12214	#8 x 5/8"
12215	#8 x 3/4"
12216	#8 x 1"
12217	#8 x 1-1/4"
12218	#8 x 1-1/2"
12953	#10 x 3/4"
12954	#10 x 1"
Black Oxide Phillips Oval Head	
10162	#8 x 1/2" w/#6 Hd.
10163	#8 x 1/2"
10164	#8 x 3/4" w/#6 Hd.
10165	#8 x 3/4"
10166	#8 x 1" w/#6 Hd.
10167	#8 x 1"
10168	#8 x 1-1/4" w/#6 Hd.
10169	#8 x 1-1/4"
10170	#8 x 1-1/2" w/#6 Hd.
10171	#8 x 1-1/2"



No. 6851

Phillips Pan Head
Tapping Screws
Plated
18 Varieties - 457 Pieces

Auveco Part No.	Size
Zinc	
1940	#8 x 1/2"
2365	#8 x 3/4"
3079	#8 x 1"
1943	#10 x 1/2"
2366	#10 x 3/4"
3082	#10 x 1"
2367	#12 x 3/4"
3090	#14 x 3/4"
Black Oxide	
11917	#6 x 1/2"
11918	#6 x 3/4"
10180	#8 x 1/2"
10181	#8 x 3/4"
10182	#8 x 1"
10183	#8 x 1-1/4"
12799	#8 x 1-1/2"
11921	#10 x 1/2"
11922	#10 x 3/4"
11923	#10 x 1"



No. 6813

Pan Head &
Hex Washer Head
Teks® Screws
Zinc Plated
18 Varieties - 127 Pieces

Auveco Part No.	Size
Pan Head	
12095	#8 x 1/2"
9605	#8 x 1/2"
9606	#8 x 3/4"
9607	#10 x 1/2"
9608	#10 x 3/4"
9609	#10 x 1"
Hex Washer Head	
9611	#8 x 1/2"
9612	#8 x 3/4"
9613	#10 x 1/2"
9614	#10 x 5/8"
9615	#10 x 3/4"
9616	#10 x 1"
11911	#12 x 1"
11913	#12 x 1-1/2"
9620	#14 x 3/4"
11914	#14 x 1"
11915	#14 x 1-1/4"
11916	#14 x 1-1/2"

Sec. 15

"6800" SERIES QUIK-SELECT ASSORTMENTS



No. 6852

Stainless Steel Tapping Screws
12 Varieties - 216 Pieces

Auveco Part No.	Size	Head
9400	#6 x 3/4"	Oval
9404	#8 x 3/4"	Oval
9405	#8 x 1"	Oval
9407	#8 x 1-1/2"	Oval
9409	#10 x 3/4"	Oval
9410	#10 x 1"	Oval
13269	#8 x 1/2"	Pan
13270	#8 x 3/4"	Pan
13271	#8 x 1"	Pan
13274	#10 x 1/2"	Pan
13275	#10 x 3/4"	Pan
13276	#10 x 1"	Pan



No. 6811

Specialty Screws
12 Varieties - 332 Pieces

Auveco Part No.	Size
10642	#8 x 3/8"
2805	#8 x 7/16"
13025	#8 x 1/2"
12095	#8 x 1/2" Tek®
2806	#8 x 5/8"
13026	#8 x 3/4"
12739	M4.2-1.41 x 12mm
13712	M4.2-1.41 x 13mm
18340	M4.8-1.61 x 15mm
17459	M4.8-1.61 x 16mm
20259	M4.8-1.61 x 19mm
20455	M4.8-2.12 x 20mm



No. 6808

License Plate Hardware
12 Varieties - 171 Pieces

Contains the following Auveco part numbers:
1313, 2472, 2625, 3182,
5228, 5278, 8250, 8427,
8435, 9603, 11370,
11719 & 14473.



No. 6814

Body Bolts
12 Varieties - 101 Pieces

Auveco Part No.	Size
11320	5/16"-18 x 1"
12693	M6-1.0 x 20mm
12324	M6-1.0 x 20mm
12160	M6-1.0 x 22mm
12065	M6-1.0 x 25mm
12066	M6-1.0 x 25mm
12323	M6-1.0 x 25mm
12335	M6-1.0 x 28mm
12351	M6.3-1.81 x 20mm
13613	M8-1.25 x 25mm
13614	M8-1.25 x 30mm
11640	M8-1.25 x 30mm



No. 6854

Metric Specialty Screws
18 Varieties - 145 Pieces

Auveco Part No.	Size
12062	M4.2-1.41 x 10mm
12739	M4.2-1.41 x 12mm
13712	M4.2-1.41 x 13mm
12741	M4.2-1.41 x 16mm
12060	M4.2-1.41 x 20mm
12738	M4.2-1.41 x 20mm
12742	M4.2-1.41 x 20mm
15373	M4.2-1.41 x 20mm
15775	M4.2-1.41 x 20mm
17459	M4.8-1.81 x 16mm
12057	M6.3-1.81 x 16mm
15962	M6.3-1.81 x 18mm
12351	M6.3-1.81 x 20mm
16828	M6.3-1.81 x 20mm
12339	M6.3-1.81 x 25mm
12068	M6.3-1.81 x 30mm
12354	M6.3-1.81 x 30mm
12350	M8-2.12 x 20mm



No. 6853

Specialty Screws
12 Varieties - 198 Pieces

Auveco Part No.	Size
10642	#8 x 3/8"
15037	#8 x 7/16"
2805	#8 x 7/16"
12095	#8 x 1/2"
15172	#8 x 1/2"
15774	#8 x 1/2"
2806	#8 x 5/8"
12820	#8 x 3/4"
13026	#8 x 3/4"
17650	#8 x 3/4"
13709	#10 x 3/4"
16589	#10 x 3/4"



No. 6858

Pushnut Bolt Retainers
18 Varieties - 314 Pieces

Auveco Part No.	Size
16851	#6 (9/64")
10085	#8 (5/32")
16852	#10 (3/16")
10086	1/4"
10087	5/16"
9297	3/8"
9298	7/16"
9299	1/2"
12122	M5-0.8
12123	M6-1.0
14980	M6-1.0
12124	M6.3-1.0
12125	M8-1.25
12259	M8-1.25
12126	M10-1.50
12260	M10-1.50
12127	M12-1.75
16980	M14-2.0



No. 6817

Washer Type
Thread Cutting Nuts
& Push-on Retainers
18 Varieties - 385 Pieces

Auveco Part No. Size

Thread Cutting Nuts

12253	5mm	Stud Size
3403	1/8"	Stud Size
3404	3/16"	Stud Size
2896	3/16"	Stud Size
2897	1/4"	Stud Size
3405	1/4"	Stud Size
10733	5/16"	Stud Size

Push-On Retainers

8863	1/8"	Stud Size
8864	5/32"	Stud Size
8865	3/16"	Stud Size
8868	1/4"	Stud Size

Bolt Retainers

10086	1/4"	Bolt Size
10087	5/16"	Bolt Size
9297	3/8"	Bolt Size
12123	6mm	Bolt Size
12125	8mm	Bolt Size
12259	8mm	Bolt Size
12126	10mm	Bolt Size



No. 6857

Thread Cutting &
Washer Lock Nuts
18 Varieties - 227 Pieces

Auveco Part No. Size

Thread Cutting Nuts

2895	1/8"	Stud Size
3403	1/8"	Stud Size
8855	5/32"	Stud Size
2896	3/16"	Stud Size
3404	3/16"	Stud Size
3405	1/4"	Stud Size
2897	1/4"	Stud Size
10733	5/16"	Stud Size
12253	5mm	Stud Size
12255	6.3mm	Stud Size
15711	8mm	Stud Size

Washer Lock Nuts

2554	#6-32	Thread
2555	#8-32	Thread
2557	#10-24	Thread
2558	#10-24	Thread
2560	#12-24	Thread
2561	1/4"-20	Thread
2562	1/4"-20	Thread



No. 6815

Nuts: Tubular, Flat,
"J" & "U"

18 Varieties - 148 Pieces

Auveco Part No. Type

2595	1/8"	Tubular
10073	3/16"	Tubular
2099	1/8"	Flat
2092	#10-24	Flat
1903	1/4"-20	Flat
5586	1/4"-20	"J"
5589	5/16"-18	"J"
5170	3/8"-16	"J"
10666	#8	"U"
11292	#8	"U"
5197	#10-24	"U"
2293	1/4"-20	"U"
9879	#8	"U"
9880	#8	"U"
10064	#6	"U"
10065	#8	"U"
10066	#10	"U"
10067	#14	"U"



No. 6816

Extruded "U" Nuts
(Foldover Nuts)
12 Varieties - 70 Pieces

Auveco Part No. Size

8359	1/4" - 20	17/32" Hole To Edge
10051	1/4" - 20	25/32" Hole To Edge
10053	5/16" - 18	9/16" Hole To Edge
8814	5/16" - 18	27/32" Hole To Edge
10054	3/8" - 16	3/4" Hole To Edge
10055	3/8" - 16	1-1/8" Hole To Edge
12669	M6 - 1.0	13.5mm Hole To Edge
12575	M6 - 1.0	19.5mm Hole To Edge
11628	M6.3 - 1.0	13.5mm Hole To Edge
11629	M8 - 1.25	14.5mm Hole To Edge
11630	M8 - 1.25	20mm Hole To Edge
11631	M10 - 1.5	19mm Hole To Edge



No. 6869

Fender Washers
12 Varieties - 155 Pieces

Auveco Part No. Dimensions

2007	3/16"	Bolt Size, 1/2" O.D.
1183	3/16"	Bolt Size, 3/4" O.D.
16018	3/16"	Bolt Size, 1" O.D.
16020	1/4"	Bolt Size, 1" O.D.
2333	1/4"	Bolt Size, 1-1/4" O.D.
768	5/16"	Bolt Size, 1-1/4" O.D.
17095	5/16"	Bolt Size, 1-1/4" O.D.
1700	5/16"	Bolt Size, 1-1/2" O.D.
3553	3/8"	Bolt Size, 1-1/4" O.D.
2227	3/8"	Bolt Size, 1-1/2" O.D.
1294	3/8"	Bolt Size, 1-3/4" O.D.
17094	3/8"	Bolt Size, 1-3/4" O.D.

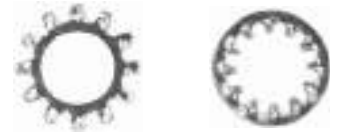

No. 6856

External & Internal
Lock Washers
12 Varieties - 685 Pieces

Auveco Part No. Size

External	
5251	#8 (5/32")
5252	#10 (3/16")
5254	#14 (1/4")
5255	5/16"
5256	3/8"
5257	7/16"
Internal	
5261	#8 (5/32")
5262	#10 (3/16")
5264	#14 (1/4")
5265	5/16"
5266	3/8"
5267	7/16"

Sec. 15

"6800" SERIES QUIK-SELECT ASSORTMENTS



No. 6868

Shims - Zinc Plated
6 Varieties - 100 Pieces

Auveco Part No.	Dimensions
2453	1/8" Thick, 1-3/4" x 1-1/4"
3000	1/8" Thick, 2" x 1-1/2"
3155	1/16" Thick, 1-1/4" x 1-1/8"
3156	1/8" Thick, 1-1/4" x 1-1/8"
5076	1/16" Thick, 1-1/8" x 1-1/8"
5077	1/8" Thick, 1-1/8" x 1-1/8"



6830

Hair Pin Cotters
6 Varieties - 73 Pieces

Auveco Part No.	Overall Length
10397	3-15/16"
11872	1-9/16"
10398	4"
10395	2-1/2"
10396	3-3/4"
10394	2-5/16"



No. 6818

Cotter Pins
Zinc Plated
18 Varieties-570 Pieces

Auveco Part No.	Size
8477	1/16" x 1/2"
8478	1/16" x 3/4"
8479	1/16" x 1"
8480	1/16" x 1-1/2"
8481	3/32" x 3/4"
8482	3/32" x 1"
8484	3/32" x 1-1/2"
8485	3/32" x 2"
8486	1/8" x 1"
8487	1/8" x 1-1/4"
8488	1/8" x 1-1/2"
8489	1/8" x 1-3/4"
8490	1/8" x 2"
8492	5/32" x 1"
8493	5/32" x 1-1/2"
8494	5/32" x 2"
8495	3/16" x 1-1/2"
8496	3/16" x 2"



No. 6863

External & Internal Retaining Rings
Zinc Plated
18 Varieties - 151 Pieces

Auveco Part No.	Shaft Diameter
Internal Type	
8688	1/4"
8689	5/16"
8690	3/8"
8691	7/16"
8693	9/16"
8694	5/8"
External Type	
8701	1/4"
8702	5/16"
8703	3/8"
8704	7/16"
8705	1/2"
8706	9/16"
8707	5/8"
8708	3/4"
8709	7/8"
8710	1"
8712	1-1/4"
10125	1-1/2"



No. 6862

"E" Type Retaining Rings
12 Varieties - 343 Pieces

Auveco Part No.	Shaft Diameter
8825	3/32"
8826	1/8"
10131	5/32"
8827	3/16"
10133	7/32"
8828	1/4"
3824	5/16"
8829	3/8"
8830	7/16"
5602	1/2"
5603	5/8"
8831	3/4"



No. 6861

Spring Pins
Zinc Plated
12 Varieties - 174 Pieces

Auveco Part No.	Size
9006	1/8" x 3/4"
9008	1/8" x 1"
9010	1/8" x 1-1/2"
9016	5/32" x 1"
9018	5/32" x 1-1/2"
9022	3/16" x 1"
9024	3/16" x 1-1/2"
9026	3/16" x 2"
9033	1/4" x 1"
9035	1/4" x 1-1/2"
9037	1/4" x 2"
9045	5/16" x 2"



No. 6831

Plastic Plug Buttons
6 Varieties - 305 Pieces

Auveco Part No.	Size
Depressed Center Type	
9288	1/2" Hole Size
9289	3/4" Hole Size
Flush Type	
14923	3/8" Hole Size
11746	1/2" Hole Size
11747	3/4" Hole Size
11749	1" Hole Size



No. 6826

Rubber Vacuum Caps
6 Varieties - 121 Pieces

Auveco Part No.	Size
12209	Fits 1/8" O.D. Tube
4440	Fits 3/16" O.D. Tube
4439	Fits 1/4" O.D. Tube
12907	Fits 5/16" O.D. Tube
12210	Fits 3/8" O.D. Tube
12908	Fits 1/2" O.D. Tube



No. 6836
Nylon Connectors
12 Varieties - 83 Pieces

Auveco Part No.	Size	
11738	1/4" x 1/4" x 3/16"	Tee
12918	3/16 x 3/16" x 3/16"	Tee
12919	1/4" x 3/16" x 3/16"	Tee
12920	5/16" x 5/16" x 5/16"	Tee
12921	3/8" x 3/8" x 1/4"	Tee
12923	1/8" x 1/8" x 1/8"	Tee
12926	3/16" x 3/16" x 1/8"	Tee
12929	1/8" x 1/8"	Straight
12930	1/8" x 3/16"	Straight
12931	1/4" x 1/4"	Straight
12935	1/4" x 3/16"	Straight
12937	3/16" x 3/16"	Straight



No. 6825
Oil Drain Plug Gaskets
12 Varieties - 84 Pieces

Auveco Part No.	Size	
8277	1/2"	Nylon
15918	1/2"	Copper
15919	9/16"	Copper
16026	1/2"	Steel & Rubber
16955	18mm	Aluminum
16956	14mm	Aluminum
16996	1/2"	Nylon
17628	12mm	Fibre
18299	14mm	Steel & Ruber
18665	11mm	Rubber
18726	12mm	Fibre
19630	11mm	Rubber



No. 6859
Hose Connectors
12 Varieties - 61 Pieces

Auveco Part No.	Size	
10101	1/8" x 1/8"	Straight
10102	3/16" x 3/16"	Straight
10103	1/4" x 1/4"	Straight
10104	5/16" x 5/16"	Straight
10105	3/8" x 3/8"	Straight
10106	1/4" x 3/16"	Straight
10107	3/8" x 1/4"	Straight
10697	1/8" x 1/8" x 1/8"	Tee
10108	5/32" x 5/32" x 5/32"	Tee
10109	3/16" x 3/16" x 3/16"	Tee
10110	1/4" x 1/4" x 1/4"	Tee
11228	3/8" x 3/8" x 3/8"	Tee



No. 6867
Wire Loom Routing Clips
6 Varieties - 42 Pieces

Auveco Part No.	For Loom Size
14544	11/32" I.D., 1/2" O.D.
14545	13/32" I.D., 19/32" O.D.
14546	1/2" I.D., 11/16" O.D.
14547	3/4" I.D., 1" O.D.
16941	1" I.D., 1-9/32" O.D.
19440	1/4" I.D., 3/8" O.D.



No. 6820
Oil Drain Plug Gaskets
12 Varieties-120 Pieces

Auveco Part No.	Size	
8277	1/2"	Nylon
8278	5/8"	Nylon
8279	3/4"	Nylon
8281	9/16"	Nylon
16680	12mm	Nylon
16681	14mm	Nylon
16682	14mm	Fibre
16685	20mm	Nylon
16996	1/2"	Nylon
17628	12mm	Fibre
18019	1/2"	Fibre
18726	12mm	Fibre



No. 6843
Vinyl Insulated Solderless Terminals
12 Varieties - 125 Pieces

Auveco Part No.	Description
5023	Ring Type, 22-18 Ga.
5026	Ring Type, 16-14 Ga.
5027	Ring Type, 16-14 Ga.
5028	Ring Type, 12-10 Ga.
5029	Ring Type, 12-10 Ga.
5031	Ring Type, 12-10 Ga.
5036	Spade Type, 16-14 Ga.
5047	Butt Conn., 22-18 Ga.
5048	Butt Conn., 16-14 Ga.
5049	Butt Conn., 12-10 Ga.
12144	Ring Type, 16-14 Ga.
17037	Butt Connector, 8 Ga.



No. 6842
Nylon Insulated Solderless Terminals
12 Varieties - 100 Pieces

Auveco Part No.	Description
5791	Butt Conn., 22-18 Ga.
5792	Butt Conn., 16-14 Ga.
5793	Butt Conn., 12-10 Ga.
9055	Ring Type, 16-14 Ga.
9056	Ring Type, 16-14 Ga.
9060	Spade Type, 16-14 Ga.
12147	Male Q. C. 16-14 Ga.
12148	Female Q.C., 16-14 Ga.
12150	Ring Type, 22-18 Ga.
12151	Ring Type, 12-10 Ga.
12152	Ring Type, 12-10 Ga.
12153	Ring Type, 12-10 Ga.



No. 6840

Pan'l Blind Rivets
12 Varieties - 291 Pieces

Auveco Part No.	Size
1/8" Diameter	
8309	Grip: 1/16"-1/8"; Alum./Alum.
5753	Grip: 3/16"-1/4"; Steel/Steel
8925	Grip: 3/16"-1/4"; Alum./Alum.
8931	Grip: 3/16"-1/4"; Lg. Flange; Alum./Alum.
8880	Grip: 5/16"-3/8"; Steel/Steel
16031	Grip: 5/16"-3/8"; Alum./Alum.
16032	Grip: 3/8"-1/2"; Alum./Alum.
3/16" Diameter	
5755	Grip: 1/16"-1/8"; Alum./Alum.
8311	Grip: 1/8"-1/4"; Alum./Alum.
8301	Grip: 1/4"-3/8"; Alum./Alum.
8313	Grip: 1/4"-3/8"; Lg. Flange; Alum./Alum.
8938	Grip: 3/8"-1/2"; Alum./Alum.



No. 6841

Specialty Rivets
12 Varieties - 66 Pieces

Auveco Part No.	Size
1/8" Diameter	
16834	Grip: 1/8"-3/16"
17615	Grip: 3/16"-3/8"
3/16" Diameter	
16864	Grip: 3/64"-11/32"
17121	Grip: 5/64"-15/64"
14127	Grip: 3/8"-1/2"
1/4" Diameter	
11620	Grip: 1/32"-9/64"; "Peel-Type"
12653	Grip: 3/32"-1/8"; "Peel-Type"
18167	Grip: 3/32"-9/64"; "Peel-Type"
12652	Grip: 1/8"-1/4"
12655	Grip: 9/64"-3/16"; "Peel-Type"
17639	Grip: 3/16"-3/8"
11621	Grip: 33/64"-19/32"; "Peel-Type"



No. 6806

Nylon Rivets
12 Varieties-74 Pieces

Auveco Part No.	Size
13746	3/16" Dia., Grip: 1/16"-9/64"
13747	13/64" Dia., Grip: 1/16"-11/64"
13748	13/64" Dia., Grip: 1/8"-15/64"
13755	13/64" Dia., Grip: 15/64"-25/64"
14004	15/64" Dia., Grip: 11/64"-11/32"
14023	15/64" Dia., Grip: 5/32"-5/16"
18108	1/4" Dia., Grip: 5/32"-3/8"
13750	1/4" Dia., Grip: 5/32"-13/32"
13751	1/4" Dia., Grip: 5/32"-13/32"
17101	1/4" Dia., Grip: 5/16"-15/32"
13752	17/64" Dia., Grip: 3/32"-3/16"
13753	17/64" Dia., Grip: 3/32"-3/16"



No. 6827

Rubber Grommets
18 Varieties - 99 Pieces

Auveco Part No.	Size
4408	1/8" Bore Dia, 3/32" Width
4410	5/32" Bore Dia, 1/16" Width
4413	3/16" Bore Dia, 1/16" Width
4414	3/16" Bore Dia, 3/32" Width
4415	3/16" Bore Dia, 1/4" Width
4417	1/4" Bore Dia, 1/16" Width
4419	5/16" Bore Dia, 1/16" Width
4421	5/16" Bore Dia, 1/8" Width
4422	5/16" Bore Dia, 1/4" Width
4423	3/8" Bore Dia, 1/16" Width
4425	3/8" Bore Dia, 1/16" Width
4426	3/8" Bore Dia, 1/4" Width
4428	1/2" Bore Dia, 3/32" Width
4430	1/2" Bore Dia, 1/4" Width
4431	5/8" Bore Dia, 1/8" Width
4432	5/8" Bore Dia, 1/16" Width
4434	3/4" Bore Dia, 1/16" Width
4436	3/4" Bore Dia, 1/4" Width



No. 6821

Glass Shop Rivets
6 Varieties-63 Pieces

Auveco Part No.	Size
11620	1/4" Dia. Grip: 1/32"-9/64"
11621	1/4" Dia. Grip: 33/64"-19/32"
11852	1/4" Dia. Grip: 5/64"-7/64"
12653	1/4" Dia. Grip: 3/32"-1/8"
12655	1/4" Dia. Grip: 9/64"-3/16"
16834	1/8" Dia. Grip: 1/8"-3/16"



No. 6835

Rubber "O" Rings
Buna "N"
18 Varieties - 770 Pieces

Auveco Part No.	Ind. Std.	I.D.	O.D.
4305	006	1/8"	1/4"
4306	007	5/32"	9/32"
4307	008	3/16"	5/16"
4308	009	7/32"	11/32"
4309	010	1/4"	3/8"
4310	011	5/16"	7/16"
4311	012	3/8"	1/2"
4312	110	3/8"	9/16"
4313	111	7/16"	5/8"
4314	112	1/2"	11/16"
4315	113	9/16"	3/4"
4316	114	5/8"	13/16"
4317	115	11/16"	7/8"
4318	116	3/4"	15/16"
4319	210	3/4"	1"
4320	211	13/16"	1-1/16"
4321	212	7/8"	1-1/8"
4323	214	1"	1-1/4"



No. 6866

Rubber Bumpers
12 Varieties - 105 Pieces

Auveco Part No.	Application
4155	General Purpose
4188	Door & Quarter Glass
4233	General Purpose
4235	Hood & Fender
4237	General Purpose
4240	Door
4242	Hood, Trunk & Deck Lid
4244	General Purpose
4246	Gas Tank Lid
4249	General Purpose
4250	Glove Box Door
4280	License Plate



No. 6809
Window Reveal
Moulding Clips
GM & Ford
12 Varieties-132 Pieces

Contains the following Auveco part numbers: **8583, 8941, 9633, 9639, 9882, 10243, 10630, 10631, 11067, 11152, 11345 & 13564.**



No. 6822
GM Window Guides
6 Varieties-30 Pieces

Auveco Part No.	O.E.M. No.
15462	20478733
15463	20487630, 20712176
15466	20160591
15467	20123070, 20328600
17159	20747509
17176	20162174, 22543363



No. 6864
Door Lock Rod Clips
12 Varieties - 59 Pieces

Contains the following Auveco part numbers:
14967, 15518, 15673, 15674, 15675, 15759, 17069, 17122, 18392, 18393, 18926 & 20675



No. 6801
GM “Xmas Tree” Retainers
12 Varieties - 118 Pieces

Contains the following Auveco part numbers: **10621, 10831, 10832, 11146, 11612, 11678, 11796, 12137, 12731, 12737, 12766 & 12992.**



No. 6845
GM “Xmas Tree” Retainers
11 Varieties - 118 Pieces

Contains the following Auveco part numbers:
11120, 12759, 13461, 14032, 14036, 15367, 15456, 15669, 15970, 16818 & 17664.



No. 6807
Nylon Nuts & Grommets
18 Varieties - 251 Pieces

Contains the following Auveco part numbers:
2625, 3682, 8435, 9829, 9862, 10330, 11368, 11691, 11719, 11838, 11841, 11855, 12735, 13450, 13933, 13960, 14009 & 14031



No. 6802
Ford “Xmas Tree” Retainers
12 Varieties - 112 Pieces

Contains the following Auveco part numbers: **10831, 11136, 11351, 11671, 11797, 12565, 12571, 12909, 14021, 14163, 17612 & 19655**



No. 6846
Ford “Xmas Tree” Retainers
12 Varieties - 112 Pieces

Contains the following Auveco part numbers:
8853, 11136, 11672, 13470, 14757, 15478, 15479, 15480, 17102, 17339, 19655 & 20316



No. 6865
Weatherstrip Retainers
12 Varieties - 245 Pieces

Auveco Part No.	Application
8853	Ford
10744	GM
11120	GM
11129	Chrysler
11612	Ford & GM
14328	Honda
14921	Chrysler & GM
17339	Ford
18033	Chrysler
18692	Mazda & Toyota
18877	Honda
19171	Honda



No. 6803
Chrysler “Xmas Tree” Retainers
6 Varieties - 113 Pieces

Contains the following Auveco part numbers: **10831, 11136, 11146, 11351, 11678 & 17004**



No. 6847
Chrysler “Xmas Tree” Retainers
12 Varieties - 113 Pieces

Contains the following Auveco part numbers:
11129, 11136, 11675, 11679, 14921, 15481, 15543, 16818, 17004, 17975, 18033 & 20316



No. 6804

GM Push-type Retainers
12 Varieties-76 Pieces

Contains the following Auveco part numbers: 12567, 12757, 13993, 14010, 14011, 14020, 14753, 15044, 15045, 17216, 17222 & 18353.



No. 6805

Ford Push-Type Retainers
6 Varieties-68 Pieces

Contains the following Auveco part numbers: 11705, 14018, 14019, 14020, 14753 & 18894.



No. 6870

GM, Ford & Chrysler
Push-Type Retainers
11 Varieties - 116 Pieces

Contains the following Auveco part numbers: 20826, 20880, 20888, 20889, 20988, 20989, 20990, 20991, 20992, 20993 & 20994.



No. 6829

Honda Body Hardware
12 Varieties - 92 Pieces

Auveco Part No.	Description
14268	Screw Grommet
14274	Nylon Nut
14282	Retaining Clip
14313	Nylon Nut
14695	Screw Grommet
14696	Push-Type Retainer
14697	Push-Type Retainer
14698	Push-Type Retainer
16000	Push-Type Retainer
17143	Push-Type Retainer
17144	Push-Type Retainer
20564	Push-Type Retainer



No. 6837

Honda Body Hardware
12 Varieties - 61 Pieces

Auveco Part No.	Description
14289	Panel Retainer
14291	Retaining Clip
14328	Weatherstrip Clip
16779	Retaining Clip
16782	Push-Type Retainer
17057	Push-Type Retainer
17192	Push-Type Retainer
17205	Retaining Clip
17379	Push-Type Retainer
18114	Insulation Retainer
18119	Push-Type Retainer
19233	Push-Type Retainer



No. 6871

Hyundai & Kia
Clips & Fasteners
18 Varieties - 76 Pieces

Auveco Part No.	Description
20543	Hood Insulation Retainer
20566	Moulding Clip
20567	Moulding Clip
20568	Moulding Clip
20680	M6-1.0 L. P. Screw
21064	Moulding Clip
21067	Bumper & Grille Retainer
21068	Nylon Nut
21070	Trim Panel Retainer
21136	Moulding Clip
21146	Push-Type Retainer
21188	Trim Panel Retainer
21244	Moulding Clip
21312	Moulding Clip
21321	Moulding Clip
21328	Push-Type Retainer
21378	Nylon "U" Nut
21382	Cowl Vent & Grille Retainer



No. 6838

Nissan Body Hardware
12 Varieties - 58 Pieces

Auveco Part No.	Description
14352	Retaining Clip
14355	Retaining Clip
16775	Trim Panel Retainer
16776	Trim Panel Retainer
16782	Push-Type Retainer
16783	Push-Type Retainer
16843	Push-Type Retainer
17347	Push-Type Retainer
17452	Retaining Clip
17472	Push-Type Retainer
20327	Push-Type Retainer
20348	Push-Type Retainer



No. 6839

Toyota Body Hardware
12 Varieties - 73 Pieces

Auveco Part No.	Description
14144	Trim Panel Retainer
14271	Nylon Nut
15695	Retainer
16779	Retaining Clip
17206	Push-Type Retainer
17438	Grille Clip
18297	Retaining Clip
18873	Push-Type Retainer
18888	Push-Type Retainer
19739	Push-Type Retainer
20390	Moulding Clip
20391	Moulding Clip



No. 6834

Toyota Body Hardware
18 Varieties - 72 Pieces

Auveco Part No.	Description
13932	Nylon Nut
14260	Push-Type Retainer
14265	Nylon Nut
14267	Screw Grommet
14268	Screw Grommet
14269	Panel Retainer
14274	Nylon Nut
14275	Screw Grommet
14276	Nylon “U” Nut
14695	Screw Grommet
14736	Retaining Clip
14737	Retaining Clip
14738	Retaining Clip
14750	Nylon “U” Nut
16306	Bumper Cushion Clip
16784	Push-Type Retainer
19194	Screw Grommet
19721	Screw Grommet

Don't see the Assortment you want?

Even though we offer over 100 Quik-Select and Quik-Select II Assortments, we know you have some great ideas for new ones. We welcome all your suggestions.

Because many of our most popular assortments were created based on customer recommendations, we want to know what you want.

E-mail your new assortment suggestions to mail@auveco.com

ASSORTMENTS

In Durable Translucent Polypropylene Boxes



No. 21534

Krimp and Seal Terminals & Connectors

24 Varieties - 159 Pieces

Auveco Part No.	Description
-----------------	-------------

13656	Ring Type, 22-18 Ga.
13657	Ring Type, 22-18 Ga.
13658	Spade Type, 22-18 Ga.
13659	Butt Conn., 22-18 Ga.
13660	Female Q.C., 22-18 Ga.
13661	Male Q.C., 22-18 Ga.
13662	Ring Type, 16-14 Ga.
13663	Ring Type, 16-14 Ga.
13664	Ring Type, 16-14 Ga.
13665	Ring Type, 16-14 Ga.
13666	Ring Type, 16-14 Ga.
13669	Butt Conn., 16-14 Ga.
13670	Female Q.C., 16-14 Ga.
13671	Male Q.C., 16-14 Ga.
13672	Female Q.C., 16-14 Ga.
13673	Male, Q.C., 16-14 Ga.
13674	Ring Type, 12-10 Ga.
13675	Ring Type, 12-10 Ga.
13676	Ring Type, 12-10 Ga.
13678	Butt Conn., 12-10 Ga.
13679	Female Q.C., 12-10 Ga.
13680	Male Q.C., 12-10 Ga.
13681	Female Plug, 16-14 Ga.
13682	Male Plug, 16-14 Ga.



No. 19927

Copper Washers
6 Varieties - 150 Pieces

Auveco Part No.	Dimensions
-----------------	------------

15915	1/4" Bolt Size, 11/16" O.D.
15913	5/16" Bolt Size, 9/16" O.D.
15916	5/16" Bolt Size, 3/4" O.D.
15917	3/8" Bolt Size, 13/16" O.D.
15918	7/16" Bolt Size, 7/8" O.D.
15919	1/2" Bolt Size, 13/16" O.D.



No. 19442

Extension Springs
Zinc Plated
6 Varieties - 38 Pieces

Contains the following
Auveco part numbers:
14063, 14064, 14065
14067, 14070 & 14072



No. 21471

Oil Drain Plugs & Gaskets
12 Varieties - 24 Pieces

Auveco Part No.	Size
-----------------	------

14196	1/2"-20 x 1/2"
18373	1/2"-20 x 13/16"
18374	M12-1.75 x 21mm
21047	M12-1.75 x 25mm
14677	M12-1.75 x 26mm
16308	M14-1.5 x 11mm
18375	M14-1.5 x 18mm
14678	M14-1.5 x 20mm
19141	M14-1.5 x 20mm
19279	M14-1.5 x 20mm
19773	M14-1.5 x 20mm
15529	M18-1.5 x 12mm



No. 19445

GM O.E.M. Electrical Terminals
12 Varieties - 223 Pieces

Contains the following
Auveco part numbers:
8774, 8776, 14150,
14151, 14152, 14880,
14881, 14883, 15497,
15498, 15937 & 15948.



No. 19443

U.S. Grease Fittings
Plated
12 Varieties - 92 Pieces

Auveco Part No.	Type
-----------------	------

9257	1/4"-28, Straight (Short)
9258	1/4"-28, Straight (Long)
9259	1/4"-28, Straight (X-Long)
9260	1/4"-28, 45 Degree
9261	1/4"-28, 90 Degree
9262	1/8" Pipe, Straight (Short)
9267	1/8" Pipe, Straight (Long)
15066	1/8" Pipe, Straight (Self-Tapping)
9264	1/8" Pipe, 45 Degree
9265	1/8" Pipe, 65 Degree
9266	1/8" Pipe, 90 Degree
15059	1/4" Pipe, Straight



No. 19444

Metric Grease Fittings
Plated
12 Varieties - 89 Pieces

Auveco Part No.	Type
-----------------	------

11097	6mm-1.00, Straight
11775	6mm-1.00, 45 Degree
11776	6mm-1.00, 90 Degree
11098	8mm-1.00, Straight
11777	8mm-1.00, 45 Degree
11099	8mm-1.00, 90 Degree
11778	8mm-1.25, Straight
11779	8mm-1.25, 45 Degree
11780	8mm-1.25, 90 Degree
11100	10mm-1.00, Straight
15067	10mm-1.00, 45 Degree
11101	10mm-1.00, 90 Degree

ASSORTMENTS

In Durable Translucent Polypropylene Boxes

Sec. 15



No. 17359
Door Hinge Bushings
8 Varieties - 136 Pieces



No. 17358
Door Hinge Pins
6 Varieties - 27 Pieces

Auveco Part No.	Application
14548	GM
14549	GM
14550	GM, Ford
14551	Ford
14552	Chrysler
14553	GM
16936	GM
16937	GM

Auveco Part No.	Application
14559	GM
17343	GM
17437	GM
19183	GM
19424	GM
19781	GM

“FP” 4 PACK ASSORTMENTS

The Auveco “FP” 4 Pack assortment is packed in a four compartment easy open translucent polypropylene box. Each assortment contains four carefully selected items designed for the customer that requires maximum coverage for a minimum investment.



Auveco Part No.	Description
FP-100	Phillips Oval Head Tapping Screws, Chrome
FP-102	Phillips Oval Head Tapping Screws, Chrome
FP-104	Phillips Oval Head Tapping Screws, Chrome
FP-108	Phillips Oval Head Tapping Screws, Chrome
FP-123	Phillips Oval Head Sems® Screws, Chrome
FP-131	Hex Washer Head Tapping Screws
FP-132	Hex Washer Head Tapping Screws
FP-159	Washer Lock Nuts
FP-160	Thread Cutting Nuts
FP-163	Tubular Nuts
FP-164	Tubular Nuts
FP-168	“J” & “U” Nuts
FP-169	“J” Type Cage Nuts
FP-171	Flat Washers

Auveco Part No.	Description
FP-178	Shims
FP-179	Shims
FP-183	Cotter Pins
FP-188	Plug Buttons
FP-193	Grease Fittings
FP-194	Grease Fittings
FP-210	Universal Moulding Fasteners
FP-224	Phillips Oval Head Tapping Screws, B. Oxide
FP-232	Phillips Oval Head Sems® Screws, Phos
FP-233	Phillips Flat Washer Head Tapping Screws, Black E-Coat
FP-243	Push-On Retainers
FP-247	Spring Type “U” Nuts



FP-100
Phillips Oval Head Tapping Screws
Chrome
150 Pieces

Auveco Part No.	Size
1794	6 x 3/4"
2698	6 x 1/2"
1796	6 x 1"
1797	6 x 1-1/4"



FP-102
Phillips Oval Head Tapping Screws
Chrome
140 Pieces

Auveco Part No.	Size
2707	8 x 1/2"
2710	8 x 3/4"
2713	8 x 1"
2716	8 x 1-1/4"

Sec. 15

"FP" 4 PACK ASSORTMENTS



FP-104

Phillips Oval Head Tapping Screws
No. 6 Head - Chrome
130 Pieces

Auveco
Part No. Size

2027	8 x 1/2"
1799	8 x 3/4"
1483	8 x 1"
1423	8 x 1-1/4"



FP-108

Phillips Oval Head Tapping Screws
No. 8 Head - Chrome
115 Pieces

Auveco
Part No. Size

2724	10 x 5/8"
1717	10 x 3/4"
2730	10 x 1"
2734	10 x 1-1/4"



FP-224

Phillips Oval Head Tapping Screws
Black Oxide
245 Pieces

Auveco
Part No. Size

10163	8 x 1/2"
10165	8 x 3/4"
10167	8 x 1"
10169	8 x 1-1/4"



FP-233

Phillips Flat Washer Head
Tapping Screws
Black E-Coat
220 Pieces

Auveco
Part No. Size

12213	8 x 1/2"
12214	8 x 5/8"
12215	8 x 3/4"
12216	8 x 1"



FP-243

Push-On Retainers
Zinc
260 Pieces

Auveco
Part No. Size

8863	1/8" Stud, 3/8" O.D.
8865	3/16" Stud, 7/16" O.D.
8868	1/4" Stud, 17/32" O.D.
8869	5/16" Stud, 5/8" O.D.



FP-123

Phillips Oval Head Sems[®]
Tapping Screws
Chrome
90 Pieces

Auveco
Part No. Size

2771	8 x 5/8"
2751	8 x 3/4"
2772	8 x 1"
3466	10 x 3/4"



FP-131

Hex Washer Head
Tapping Screws
Zinc
165 Pieces

Auveco
Part No. Size

2369	10 x 1/2"
2809	10 x 5/8"
2967	12 x 5/8"
2968	12 x 3/4"



FP-159

Washer Lock Nuts
Zinc
240 Pieces

Auveco
Part No. THD. O.D.

2555	8-32	15/32"
2556	10-32	1/2"
2557	10-24	1/2"
2558	10-24	3/4"



FP-232

Phillips Oval Head Sems[®]
Tapping Screws
Black Phosphate
100 Pieces

Auveco
Part No. Size

11788	8 x 3/4"
11789	8 x 1"
11791	10 x 3/4"
11792	10 x 1"



FP-132

Hex Washer Head
Tapping Screws
Zinc
75 Pieces

Auveco
Part No. Size

2370	14 x 5/8"
2330	14 x 3/4"
2974	14 x 1"
2978	5/16" x 3/4"



FP-160

Thread Cutting Nuts
Zinc
125 Pieces

Auveco
Part No. Stud Size O.D.

3403	1/8"	7/16"
2895	1/8"	17/32"
2896	3/16"	5/8"
2897	1/4"	19/32"

"FP" 4 PACK ASSORTMENTS



FP-168
"J" And "U" Type Nuts
48 Pieces

Auveco Part No.	Screw Size
1907	5/16"-10
2057	#14
2420	#14
2293	1/4"-20



FP-247
Spring Type "U" Nuts
Phosphate
70 Pieces

Auveco Part No.	Size
10064	#6 Screw Size
10065	#8 Screw Size
10066	#10 Screw Size
10067	#14 Screw Size



FP-179
Caster & Camber
Shims-Plated
65 Pieces

Auveco Part No.	Thick	Size
5074	1/64"	1-1/8" x 1-1/8"
5075	1/32"	1-1/8" x 1-1/8"
5076	1/16"	1-1/8" x 1-1/8"
5077	1/8"	1-1/8" x 1-1/8"



FP-169
"J" Type
Cage Nuts
28 Pieces

Auveco Part No.	Thread Size
5589	5/16"-18
5170	3/8"-16
5586	1/4"-20



FP-171
Fender Washers
Zinc Plated
200 Pieces

Auveco Part No.	Bolt Size	O.D.
1183	3/16"	3/4"
2333	1/4"	1-1/4"
768	5/16"	1-1/4"
3553	3/8"	1-1/4"



FP-183
Hammer Lock
Cotter Pins
Plated
240 Pieces

Auveco Part No.	Size
8482	3/32" x 1"
8484	3/32" x 1-1/2"
8488	1/8" x 1-1/2"
8490	1/8" x 2"



FP-188
Plug Buttons
Nickel Plated
37 Pieces

Auveco Part No.	Hole Size
3751	3/8"
3752	1/2"
3753	5/8"
3755	7/8"



FP-163
Tubular Nuts
80 Pieces

Auveco Part No.	Stud Size
2611	1/8"
11293	1/8"
3776	3/32"
2565	3/16"



FP-210
Universal Moulding
Fasteners - With Nuts
18 Moulding Fasteners

Contains the following
Auveco Part Numbers: **2818,**
2619, 2752 & 19626.



FP-193
Ball Check
Grease Fittings
34 Pieces

Auveco Part No.	Size
9257	1/4"-28 Short
9258	1/4"-28 Long
9259	1/4"-28 Extra Long
9262	1/8" Pipe Thread



FP-164
Tubular Nuts
75 Pieces

Auveco Part No.	Stud Size
2595	1/8"
3137	3/32"
10073	3/16"
5196	1/4"



FP-178
Shims - Plated
75 Pieces

Auveco Part No.	Size	Thick	Slot
3155	1-1/4" x 1-1/8"	1/16"	3/8"
3156	1-1/4" x 1-1/8"	1/8"	3/8"
2452	1-3/4" x 1-1/4"	1/16"	1/2"
2453	1-3/4" x 1-1/4"	1/8"	1/2"



FP-194
Ball Check
Grease Fittings
22 Pieces

Auveco Part No.	Size
9260	1/4"-28, 45°
9261	1/4"-28, 90°
9264	1/8" Pipe, 45°
9265	1/8" Pipe, 65°

“O” RING ASSORTMENTS



15961

Metric Buna “N” Rubber
“O” Rings
36 Varieties - 500 Pieces

Auveco Part No.	I.D.	O.D.
16647	2.2mm	5.4mm
16648	3.1mm	6.3mm
15764	4mm	8mm
16649	4.1mm	7.3mm
16651	4.3mm	9.1mm
16650	5mm	8mm
16642	5.3mm	10.1mm
16644	5.6mm	10.4mm
15765	6mm	10mm
16643	7.1mm	10.3mm
16646	7.6mm	12.4mm
16645	8mm	12mm
16638	8.3mm	13.1mm
16640	8.6mm	13.4mm
15766	9mm	13mm
16633	9mm	15mm
16637	9.1mm	12.3mm
16641	10mm	14mm
15767	10mm	15mm
16634	10mm	16mm
16639	10.1mm	13.3mm
16636	11mm	17mm
15768	12mm	16mm
16635	13mm	16mm
15769	13mm	18mm
16628	13.1mm	16.3mm
16629	14mm	18mm
16630	14mm	19mm
16632	15mm	20mm
16631	16mm	19mm
15770	16mm	20mm
16626	17mm	22mm
16627	18mm	23mm
15771	19mm	23mm
15772	19mm	24mm
15773	20mm	24mm

18885

Air Conditioning Nitrile “O” Rings
**For use with R134A
& R12 refrigerant**
18 Varieties - 203 Pieces

Auveco Part No.	I.D.	O.D.	Thick-ness
17604	.290"	.432"	.071"
18646	3/8"	1/2"	1/16"
17605	.400"	.546"	.073"
17606	.509"	.655"	.073"
17607	.617"	.769"	.076"
18647	11/16"	13/16"	1/16"
18134	4.5mm	7.3mm	1.4mm
18135	6mm	9.6mm	1.8mm
18136	6.5mm	9.5mm	1.5mm
18137	6.6mm	10.2mm	1.8mm
18138	7.7mm	11.3mm	1.8mm
18140	10.7mm	15.5mm	2.4mm
18139	10.8mm	14.4mm	1.8mm
18141	13.3mm	18.1mm	2.4mm
18143	13.4mm	17.2mm	1.9mm
18142	14mm	17.6mm	1.8mm
18144	14.8mm	19.6mm	2.4mm
19235	13/16"	1-1/16"	1/8"

18886

Air Conditioning
Blue Neoprene (Teflon Coated)
“O” Rings
**For use with R134A
& R12 refrigerant**
11 Varieties - 288 Pieces

Auveco Part No.	Ind. Std.	I.D.	O.D.	Thick-ness
18533	108	1/4"	7/16"	3/32"
18534	011	5/16"	7/16"	1/16"
18535	012	3/8"	1/2"	1/16"
18536	110	3/8"	9/16"	3/32"
18537	013	7/16"	9/16"	1/16"
18538	014	1/2"	5/8"	1/16"
18539	112	1/2"	11/16"	3/32"
18540	015	9/16"	11/16"	1/16"
18541	113	9/16"	3/4"	3/32"
19665	114	5/8"	13/16"	3/32"
18543	017	11/16"	13/16"	1/16"

Do You Want Your
Customers To Know You
Use The Best Body
Hardware & Specialty
Fasteners Available?
Promotional Products And
Apparel Bearing The
Auveco Logo
Promote Your Identify As A
Professional.

BUNA "N" RUBBER "O" RINGS

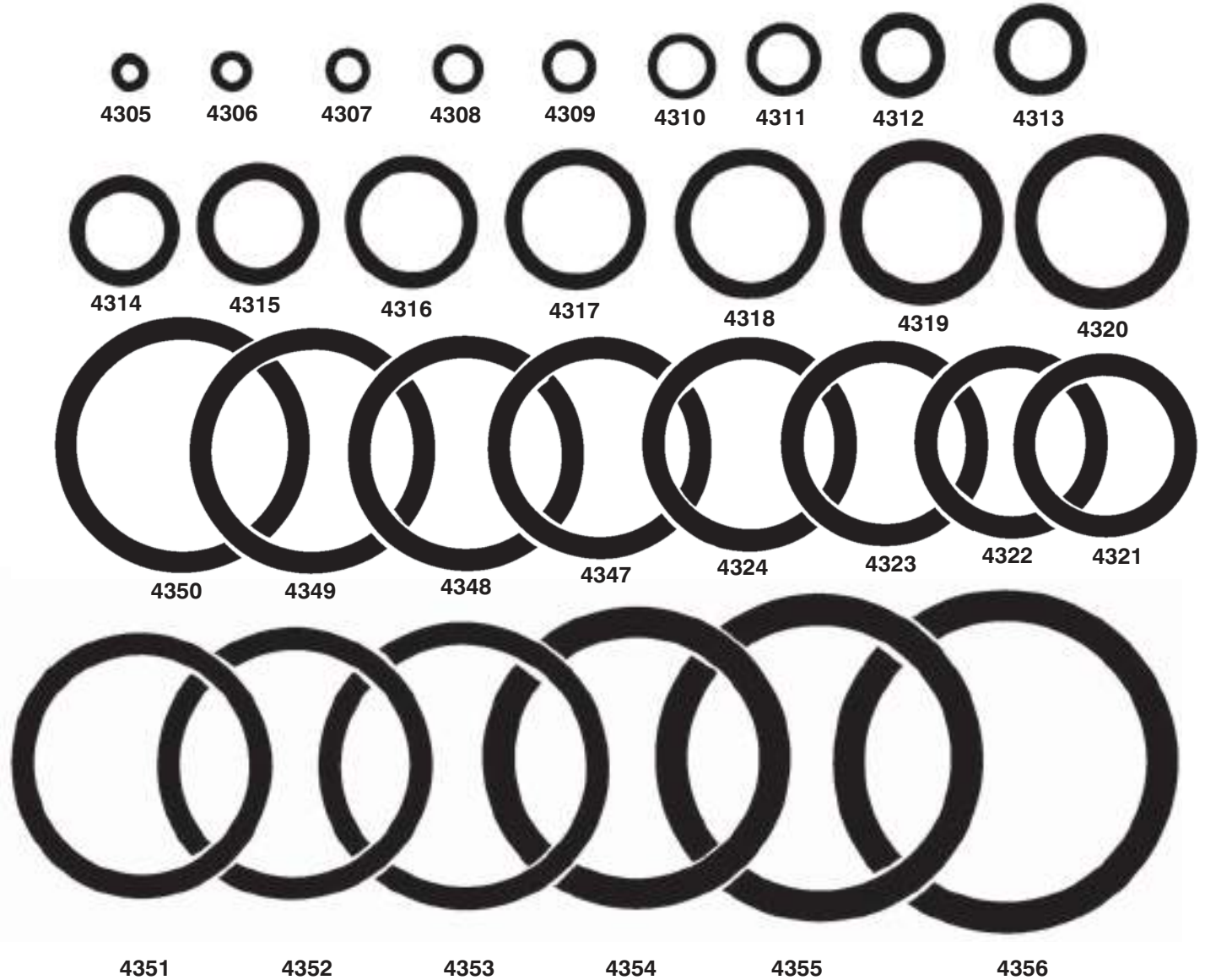

THICKNESS
 4305 thru 43111/16"
 4312 thru 43183/32"
 4319 thru 43531/8"
 4354 thru 435613/64"
 Temperature Rating: 70 hours @ 100°C

Auveco Part No.	Ind. Std.	I.D.	O.D.	Unit Pkg.	Auveco Part No.	Ind. Std.	I.D.	O.D.	Unit Pkg.
4305	006	1/8"	1/4"	50	4320	211	13/16"	1-1/16"	50
4306	007	5/32"	9/32"	50	4321	212	7/8"	1-1/8"	50
4307	008	3/16"	5/16"	50	4322	213	15/16"	1-3/16"	50
4308	009	7/32"	11/32"	50	4323	214	1"	1-1/4"	50
4309	010	1/4"	3/8"	50	4324	215	1-1/16"	1-5/16"	50
4310	011	5/16"	7/16"	50	4347	216	1-1/8"	1-3/8"	25
4311	012	3/8"	1/2"	50	4348	217	1-3/16"	1-7/16"	25
4312	110	3/8"	9/16"	50	4349	218	1-1/4"	1-1/2"	25
4313	111	7/16"	5/8"	50	4350	219	1-5/16"	1-9/16"	25
4314	112	1/2"	11/16"	50	4351	220	1-3/8"	1-5/8"	25
4315	113	9/16"	3/4"	50	4352	221	1-7/16"	1-11/16"	25
4316	114	5/8"	13/16"	50	4353	222	1-1/2"	1-3/4"	25
4317	115	11/16"	7/8"	50	4354	325	1-1/2"	1-7/8"	25
4318	116	3/4"	15/16"	50	4355	326	1-5/8"	2"	25
4319	210	3/4"	1"	50	4356	327	1-3/4"	2-1/8"	25

Sec. 16

METRIC BUNA "N" RUBBER "O" RINGS

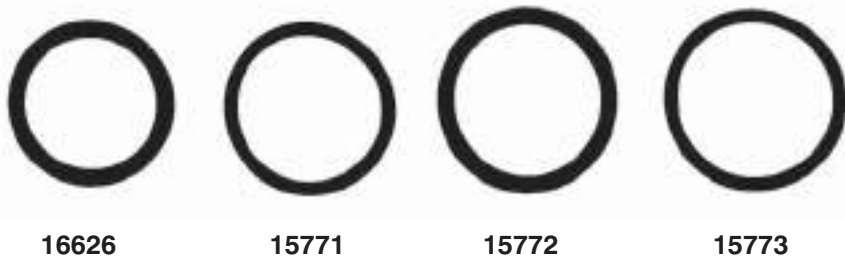
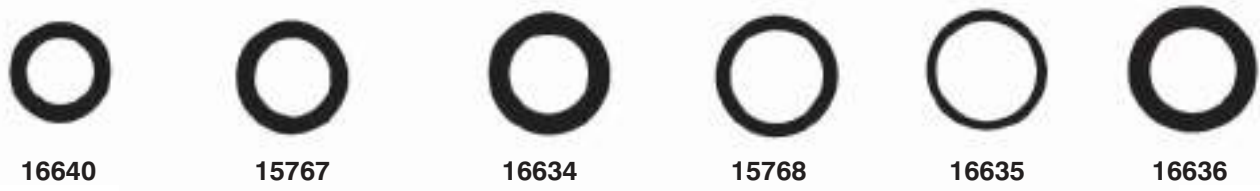
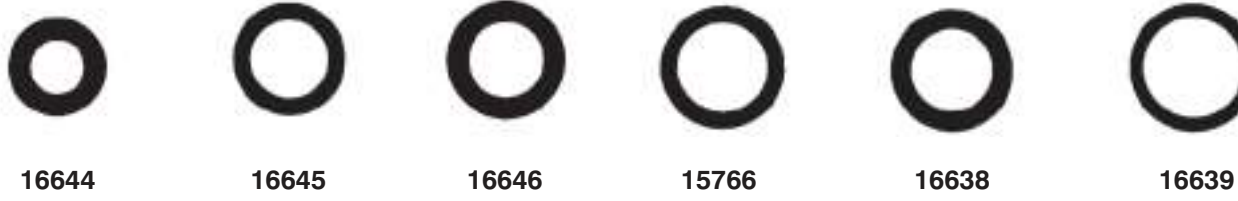

Auveco Part No.	I.D.	O.D.	Thickness	Unit Pkg.
16647	2.2mm	5.4mm	1.6mm	50
16648	3.1mm	6.3mm	1.6mm	50
15764	4mm	8mm	2mm	100
16649	4.1mm	7.3mm	1.6mm	50
16651	4.3mm	9.1mm	2.4mm	50
16650	5mm	8mm	1.5mm	50
16642	5.3mm	10.1mm	2.4mm	50
16644	5.6mm	10.4mm	2.4mm	50
15765	6mm	10mm	2mm	100
16643	7.1mm	10.3mm	1.6mm	50
16646	7.6mm	12.4mm	2.4mm	50
16645	8mm	12mm	2mm	50
16638	8.3mm	13.1mm	2.4mm	50
16640	8.6mm	13.4mm	2.4mm	50
15766	9mm	13mm	2mm	100

Auveco Part No.	I.D.	O.D.	Thickness	Unit Pkg.
15767	10mm	15mm	2.5mm	100
16634	10mm	16mm	3mm	50
16639	10.1mm	13.3mm	1.6mm	50
16636	11mm	17mm	3mm	50
15768	12mm	16mm	2mm	100
16635	13mm	16mm	1.5mm	50
15769	13mm	18mm	2.5mm	100
16629	14mm	18mm	2mm	50
16632	15mm	20mm	2.5mm	50
16631	16mm	19mm	1.5mm	50
15770	16mm	20mm	2mm	50
16626	17mm	22mm	2.5mm	25
15771	19mm	23mm	2mm	50
15772	19mm	24mm	2.5mm	50
15773	20mm	24mm	2mm	50

AIR CONDITIONING "O" RINGS

For Use With R12 Refrigerant Only

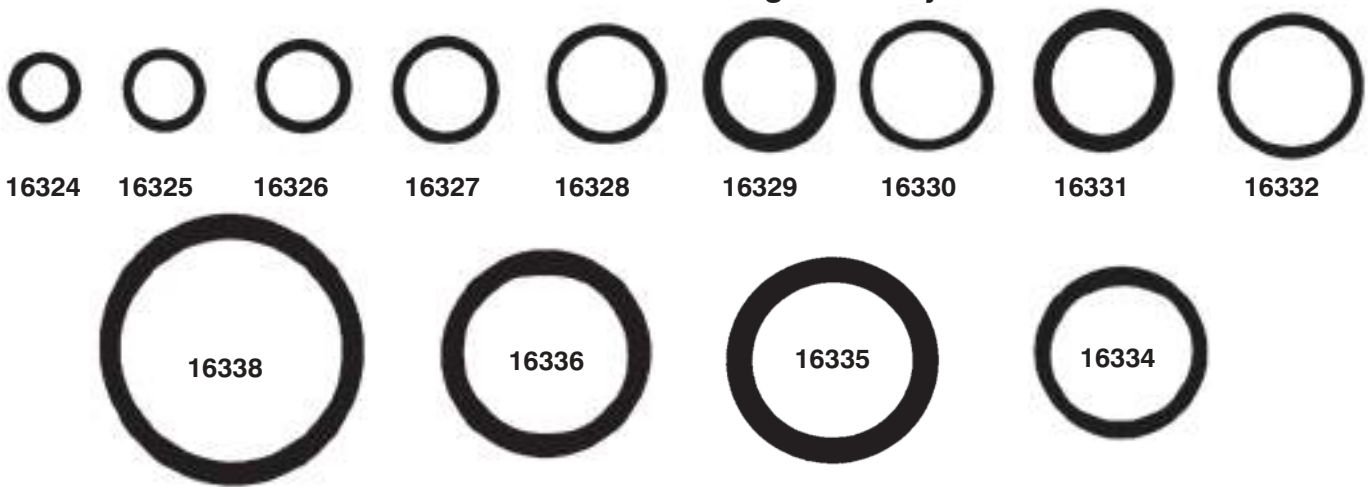

For original air conditioning systems. Not for use with R134A refrigerant.

Auveco Part No.	Ind. Std.	I.D.	O.D.	Thick-ness	Unit Pkg.	Auveco Part No.	Ind. Std.	I.D.	O.D.	Thick-ness	Unit Pkg.
16324	010	1/4"	3/8"	1/16"	50	16332	016	5/8"	3/4"	1/16"	50
16325	011	5/16"	7/16"	1/16"	50	16334	018	3/4"	7/8"	1/16"	25
16326	012	3/8"	1/2"	1/16"	50	16335	211	13/16"	1-1/16"	1/8"	10
16327	013	7/16"	9/16"	1/16"	50	16336	118	7/8"	1-1/16"	3/32"	25
16328	014	1/2"	5/8"	1/16"	50	16338	123	1-3/16"	1-3/8"	3/32"	10
16329	112	1/2"	11/16"	3/32"	25						
16330	015	9/16"	11/16"	1/16"	50						
16331	113	9/16"	3/4"	3/32"	25						

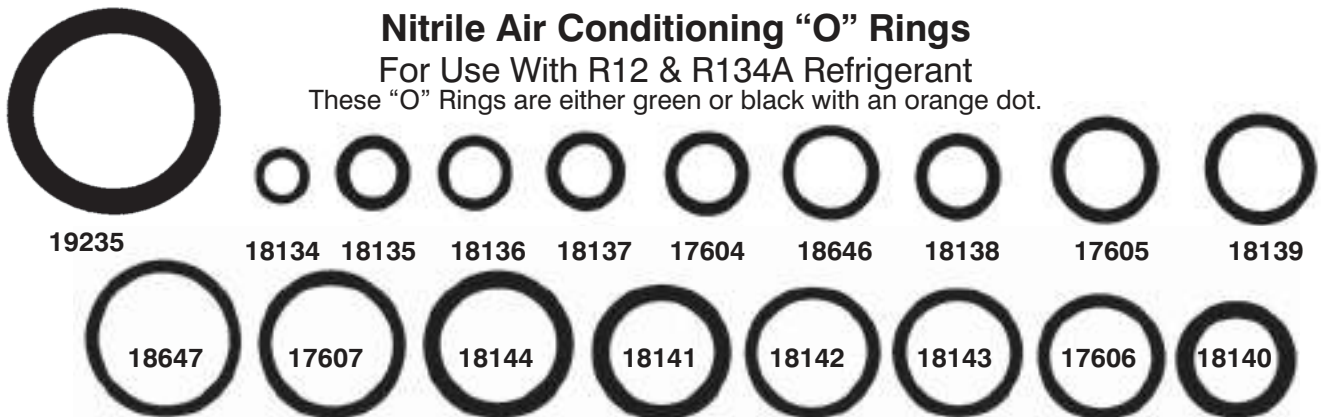

Nitrile Air Conditioning "O" Rings
 For Use With R12 & R134A Refrigerant
 These "O" Rings are either green or black with an orange dot.

Auveco Part No.	I.D.	O.D.	Thick-ness	OEM No.	Unit Pkg.
17604	.290"	.432"	.071"	Ford: 391396	25
18646	.375"	.500"	.063"		25
17605	.400"	.546"	.073"	Ford: 391397	25
17606	.509"	.655"	.073"	Ford: 391304	25
17607	.617"	.769"	.076"	Ford: 391305	15
18647	.688"	.813"	.063"		25
18134	4.5mm	7.3mm	1.4mm	Nissan: 92472-N8200	25
18135	6mm	9.6mm	1.8mm	Nissan: 92470-N8200	25
18136	6.5mm	9.5mm	1.5mm	Toyota: 90099-14044	25
18137	6.6mm	10.2mm	1.8mm	Acura: 80873-ST7-000	25
18138	7.7mm	11.3mm	1.8mm	Nissan: 92474-N8200	25
18140	10.7mm	15.5mm	2.4mm	Acura: 80872-ST7-000	25
				Nissan: 92475-W1000	
18139	10.8mm	14.4mm	1.8mm	Nissan: 92471-N8200	25
18141	13.3mm	18.1mm	2.4mm	Acura: 80871-ST7-000	25
18143	13.4mm	17.2mm	1.9mm	Toyota: 90099-14045	15
18142	14mm	17.6mm	1.8mm	Nissan: 92473-N8200	25
18144	14.8mm	19.6mm	2.4mm	Nissan: 92475-W2100	15
19235	13/16"	1-1/16"	1/8"		10

Sec. 16

BLUE NEOPRENE AIR CONDITIONING "O" RINGS

Teflon Coated • For Use With R134A & R12 Refrigerant

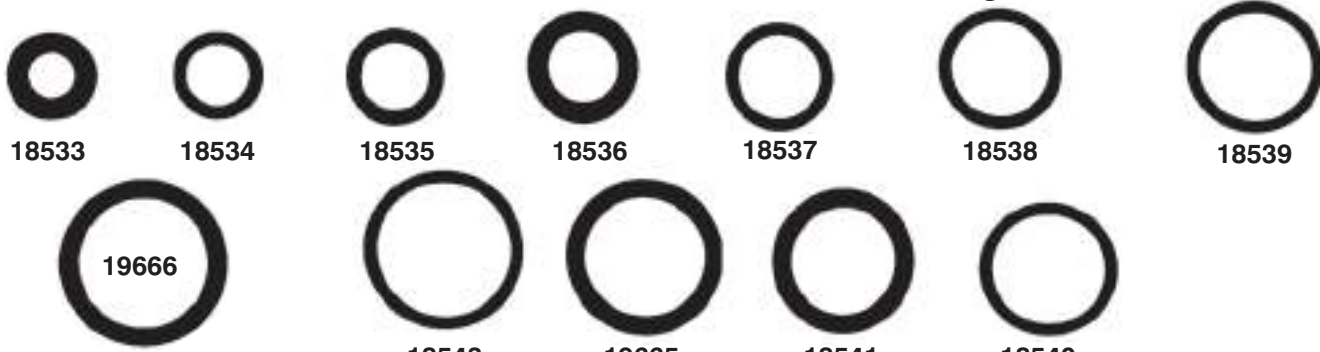

Auveco Part No.	Ind. Std.	I.D.	O.D.	Thick-ness	Unit Pkg.	Auveco Part No.	Ind. Std.	I.D.	O.D.	Thick-ness	Unit Pkg.
18533	108	1/4"	7/16"	3/32"	25	18540	015	9/16"	11/16"	1/16"	25
18534	011	5/16"	7/16"	1/16"	25	18541	113	9/16"	3/4"	3/32"	25
18535	012	3/8"	1/2"	1/16"	25	19665	114	5/8"	13/16"	3/32"	25
18536	110	3/8"	9/16"	3/32"	25	18543	017	11/16"	13/16"	1/16"	25
18537	013	7/16"	9/16"	1/16"	25	19666	115	11/16"	7/8"	3/32"	25
18538	014	1/2"	5/8"	1/16"	25						
18539	112	1/2"	11/16"	3/32"	25						

Vinyl Grommets

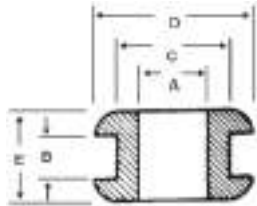

- Black Vinflex 163
- Exceptional Aging Qualities
- High Dielectric Properties
- Oil Resistant

- Non-Conductive
- Durometer Hardness 60
- Excellent Resistance to Ozone and Sunlight



Auveco Part No.	"A" Bore Diameter	"B" Groove Width	"C" Groove Diameter	"D" Outside Diameter	"E" Overall Thickness	Unit Pkg.
14764	1/4"	1/16"	3/8"	9/16"	1/4"	50
14765	5/16"	1/16"	7/16"	5/8"	1/4"	50
14767	1/2"	1/16"	5/8"	13/16"	9/32"	25

Rubber Grommets

Made of SBR Material
Durometer Hardness 60

All Packed 25

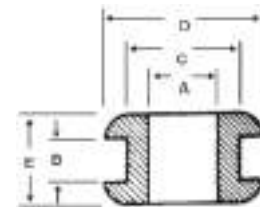

Auveco Part No.	A Bore Dia.	B Groove Width	C Groove Dia.	D Outside Dia.	E Overall Thickness	Auveco Part No.	A Bore Dia.	B Groove Width	C Groove Dia.	D Outside Dia.	E Overall Thickness
4408	1/8"	3/32"	3/8"	1/2"	5/16"	16456	3/8"	1/16"	5/8"	7/8"	11/32"
4410	5/32"	1/16"	1/4"	3/8"	3/16"	4425	3/8"	1/16"	1"	1-1/4"	1/4"
4411	5/32"	3/32"	1/4"	7/16"	3/8"	4426	3/8"	1/4"	5/8"	7/8"	1/2"
4413	3/16"	1/16"	5/16"	1/2"	1/4"	16457	7/16"	1/16"	9/16"	3/4"	1/4"
4414	3/16"	3/32"	9/32"	3/8"	5/16"	4428	1/2"	3/32"	3/4"	31/32"	9/32"
4415	3/16"	1/4"	5/16"	7/16"	3/8"	4429	1/2"	3/32"	.25/32"	1"	11/32"
16454	1/4"	1/16"	3/8"	1/2"	3/16"	16458	1/2"	1/8"	3/4"	1"	1/2"
4417	1/4"	1/16"	7/16"	5/8"	3/16"	4430	1/2"	1/4"	13/16"	1-1/16"	1/2"
4418	1/4"	1/16"	1"	1-1/4"	1/4"	4431	5/8"	1/8"	7/8"	1-1/8"	3/8"
4419	5/16"	1/16"	7/16"	9/16"	3/16"	4432	5/8"	1/16"	7/8"	1-1/8"	5/16"
4420	5/16"	1/16"	9/16"	13/16"	5/16"	4433	3/4"	1/16"	15/16"	1-1/8"	1/4"
16455	5/16"	1/16"	3/4"	1"	5/16"	4434	3/4"	1/16"	1-1/16"	1-3/8"	3/8"
4421	5/16"	1/8"	9/16"	13/16"	3/8"	4435	3/4"	1/16"	1-1/4"	1-5/8"	1/4"
4422	5/16"	1/4"	9/16"	13/16"	1/2"	4436	3/4"	1/4"	1-1/4"	1-5/8"	7/16"
4423	3/8"	1/16"	1/2"	5/8"	9/32"						

GROMMETING & TIRE VALVES

Flexible Serrated Polyethylene Grommeting (Natural Color)

Grommeting is primarily used to protect wires and cables from sharp panel edges. Wires that are routed through knock-outs or over sharp edges need to be prevented from chafing against those edges. Grommeting can also be used to protect the edges of glass, sheet metal, wood panels, or other sheet-form materials. Depending on the panel thickness of the application, grommeting may grip tightly by itself—if not, a touch of epoxy will keep it in place.

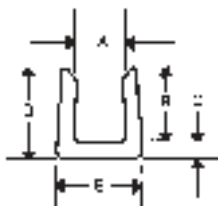

Auveco Part No.	"A" Max. Panel Thickness	"B"	"C"	"D"	"E"	Unit Pkg.
15974	.040"	.150"	.040"	.190"	.125"	100FT.
15975	.052"	.150"	.040"	.190"	.125"	100FT.
15976	.062"	.155"	.045"	.200"	.170"	100FT.
15977	.085"	.155"	.045"	.200"	.170"	100FT.
15978	.100"	.175"	.045"	.220"	.210"	100FT.
15979	.125"	.175"	.045"	.220"	.210"	100FT.
15980	.187"	.222"	.045"	.270"	.275"	100FT.

TUBELESS TIRE VALVES



1-1/4" Long
29/64" Rim Hole
(TR413)

Auveco No. **10184** - U.P. 5
 Auveco No. **10191** - U.P. 25
 Auveco No. **10192** - U.P. 100

1-1/4" Long
5/8" Rim Hole
(TR415)

Auveco No. **10204** - U.P. 100

2" Long
29/64" Rim Hole
(TR418)

Auveco No. **10186** - U.P. 5
 Auveco No. **10197** - U.P. 25
 Auveco No. **10198** - U.P. 100

SPONGE WEATHERSTRIPS

Peel-Bak Adhesive Neoprene Sponge Weatherstrip

A light-weight closed cell sponge material, Peel-Bak is an easy to apply type of weatherstrip for auto and household use. May also be used on boats, refrigerators or any place a weatherproof, permanent seal is required. Simple to use - just peel back the liner tape and press into place. No cement or tacking required. Surface must be clean and dry.

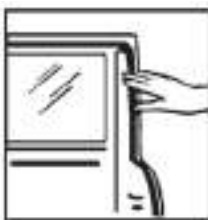

Press On
Clean Dry
Surface

Thickness	Width	10 Ft. Roll	50 Ft. Roll
		Auveco Part No.	Auveco Part No.
5/32"	3/8"	4800	4850
5/32"	1/2"	4801	4851
5/32"	5/8"	4802	
5/32"	3/4"	4803	4852
5/32"	1"	4804	4853
5/16"	3/8"	4805	4854
5/16"	1/2"	4806	4855
5/16"	5/8"	4807	
5/16"	3/4"	4808	4856
5/16"	1"	4809	4857
7/16"	3/8"	4810	4858
7/16"	1/2"	4811	4859
7/16"	3/4"	4812	4860
7/16"	1"	4813	4861

EXACT SIZE PROFILES

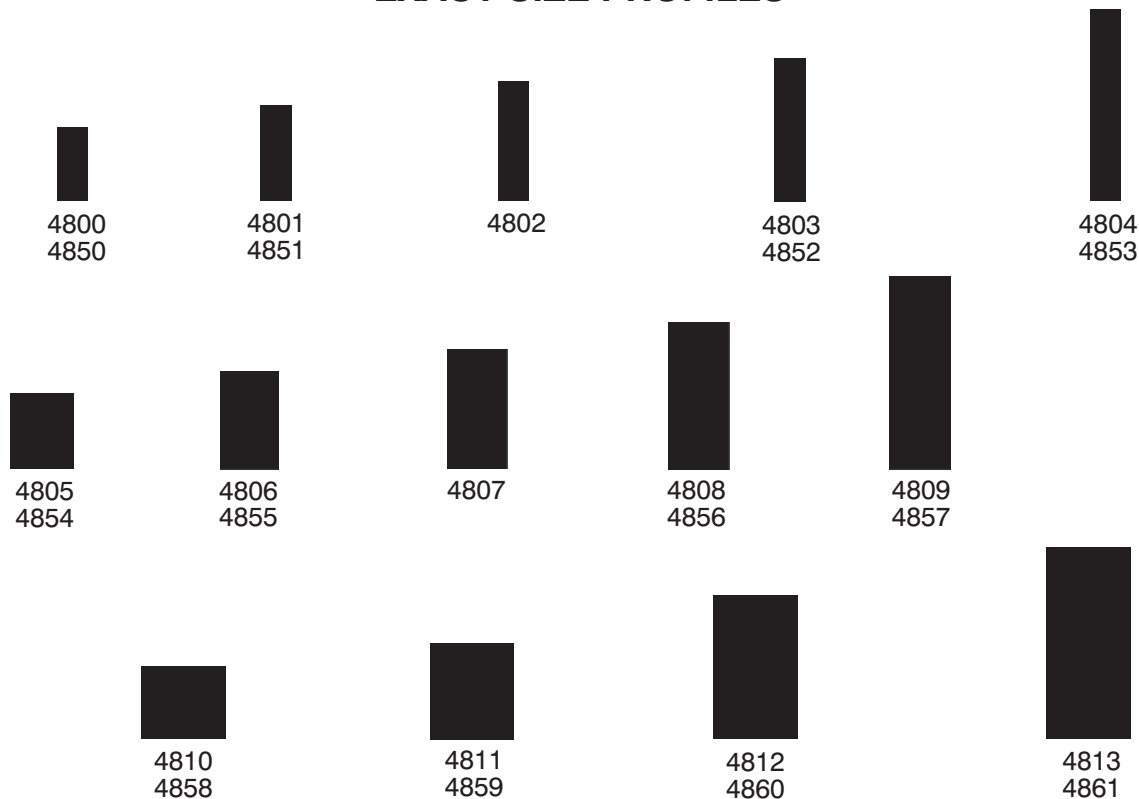

PVC FOAM ADHESIVE WEATHERSTRIPS

Sec. 16

A low density, PVC (polyvinyl chloride) foam weatherstrip with a permanent acrylic adhesive for easy application even on irregular or curved surfaces. Seals out air, moisture, dust and light as well as cushioning against vibration and noise. Remains flexible at -20° C to 80° C (-4° F to 176° F). Light gray in color.



Pull Back Tape

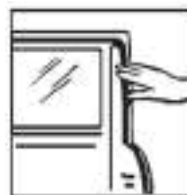

Press on Clean Dry Surface

Thickness	Width	10 Ft. Roll Auveco Part No.	25 Ft. Roll Auveco Part No.
3/16"	1/2"	20912	20913
5/16"	3/4"	20914	20915
5/16"	1"	20916	20917
7/16"	3/4"	20918	20919
7/16"	1"	20920	20921

EXACT SIZE PROFILES

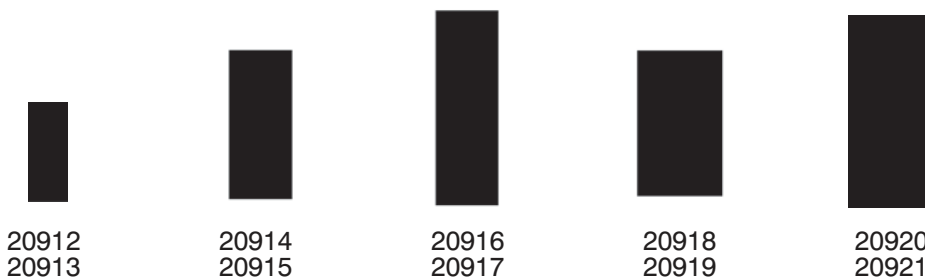

Pickup Truck Cap Weatherstrip Tape

A closed-cell foam weatherstrip tape that's used on the bottom lip of the cap or the truck's flange to form a moisture, dust and vibration resistant seal. Features an aggressive acrylic adhesive.



20922

3/16" Thick x 1-1/4" Wide x 30 Feet Long
Color: Light Gray

UNIT PACKAGE: 1 Roll

Sec. 16

SPONGE RUBBER WEATHERSTRIPS

ACTUAL SIZE ILLUSTRATIONS -EPDM CLOSED CELL

Light Weight -Weather Resistant

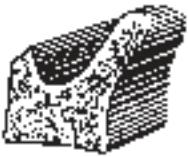

4675 UNIT PACKAGE: 50 Ft.
16390 UNIT PACKAGE: 15 Ft.

Door Flange Weatherstrip
GM, Ford & Chrysler
Cars & Trucks



4731

Door Flange Weatherstrip
GM 1954-53
Universal

UNIT PACKAGE: 50 Ft.



4744 UNIT PACKAGE: 50 Ft.
16391 UNIT PACKAGE: 15 Ft.

Door Flange Weatherstrip
GM: 1955-On



4707

Door Flange Weatherstrip
Chrysler 1954-50
Ford 1958-50

UNIT PACKAGE: 50 Ft.



4745 UNIT PACKAGE: 50 Ft.
16392 UNIT PACKAGE: 15 Ft.

Door Flange Weatherstrip
Ford 1955-On



4746 UNIT PACKAGE: 50 Ft.
16393 UNIT PACKAGE: 15 Ft.

Door Flange Weatherstrip
Chrysler 1958-On



4747

Door Inner Belt Weatherstrip
All Cars 1970-55

UNIT PACKAGE: 50 Ft.



4742

Trunk & Lid Weatherstrip
GM 1959-On
Ford 1949-On
Studebaker 1967-55

UNIT PACKAGE: 50 Ft.



16890 UNIT PACKAGE: 25 Ft.
16891 UNIT PACKAGE: 50 Ft.

Door Flange Weatherstrip
Ford 1956-53



4703 UNIT PACKAGE: 50 Ft.
16395 UNIT PACKAGE: 15 Ft.

Trunk & Rear Deck Gutter
Weatherstrip
GM



4749 UNIT PACKAGE: 50 Ft.
16394 UNIT PACKAGE: 15 Ft.

Deck Lid Weatherstrip
GM 1956-On



16892

Roof Rail Weatherstrip
GM 1977-68

UNIT PACKAGE: 25 Ft.



SPONGE RUBBER WEATHERSTRIPS

ACTUAL SIZE ILLUSTRATIONS - EPDM CLOSED CELL

Light Weight -Weather Resistant



4743

Trunk Weatherstrip
Universal

UNIT PACKAGE: 35 Ft.



4750

(C5AZ-6243720-B)

Deck Lid Weatherstrip
Ford 1956-On

UNIT PACKAGE: 50 Ft.



16524

Door Seal Weatherstrip
GM 1972-64

UNIT PACKAGE: 50 Ft.

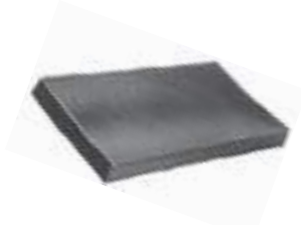

4740

19341

**Extruded Closed Cell
Sponge Rubber**

Will not absorb water or
moisture. Without Cement.

19341 1/8" Thick -3/4" Wide

4740 1/8" Thick -1-1/2" Wide

UNIT PACKAGE: 25 Ft.
(One Size)



20928

Door Flange, Trunk & Tail Gate
Weatherstrip
With 3/32" Dia. Hole
Universal

UNIT PACKAGE: 25 FT.



16525

Door Seal Weatherstrip
GM 1963-55

UNIT PACKAGE: 50 Ft.



20929

Door Flange, Trunk & Tail Gate
Weatherstrip
With 1/8" Dia. Hole
Universal

UNIT PACKAGE: 25 Ft.

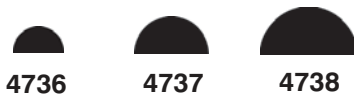

4736

4737

4738



**Closed Cell
Half Round
Sponge Rubber**

47361/4" Half Round

47373/8" Half Round

47381/2" Half Round

UNIT PACKAGE: 50 Ft.
(One Size)

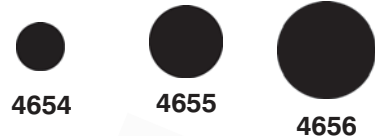

4654

4655

4656



**Closed Cell
Sponge Rubber Windlace Cord**

Flexible filler for cloth covered windlace on door and
windshield pillars and door bottoms.

46541/4" Diameter

46553/8" Diameter

46561/2" Diameter

UNIT PACKAGE: 50 Ft.
(One Size)

Sec. 16

RUBBER BUMPERS & GROMMETS

(ILLUSTRATIONS ACTUAL SIZE)



4280

(3745361, 3762180)
License Plate Bumper
GM

UNIT PACKAGE: 25



4406

Brake Adjusting Screw
Hole Rubber Plug
Fits 5/16" x 1" Hole

UNIT PACKAGE: 25

Please Order
In Unit Package
Quantities
Not Number
Of Pieces



4260

(17562)

Windshield Wiper Rubber Grommet
11/32" I.D.
5/8" O.D.
3/16" Thick
Ford

UNIT PACKAGE: 25



4246

(357811)

Gas Tank Lid Rubber Bumper
Ford

UNIT PACKAGE: 25



4242

(4137121)

Trunk, Rear Deck Lid, & Hood
Bumper
GM

UNIT PACKAGE: 25



4243

(513388)

Hood To Ledge Bumper
GM

UNIT PACKAGE: 25



4265

(3711168)

Door Lock Striker Plate,
Window Glass Stop
& License Plate Bumper
GM

UNIT PACKAGE: 25



4188

(4081765)

Door & Quarter Glass
And Door Opening Header Bumper
GM

UNIT PACKAGE: 25



4237

(3664645)

General Purpose
GM

UNIT PACKAGE: 25



4235

(3688811)

Hood Top Panel Side
Bumper To Fender
GM

UNIT PACKAGE: 25



4248

(16758)

General Purpose
Ford

UNIT PACKAGE: 25



4258

(352839)

General Purpose
Ford

UNIT PACKAGE: 25

RUBBER BUMPERS & GROMMETS

(ILLUSTRATIONS ACTUAL SIZE)



4447
(7724826)

Trunk Lid Bumper
GM

UNIT PACKAGE: 10



13967

General Purpose
Head: 1/2" O.D. x 5/16" Long
Fits Into 1/4" Hole
Durometer: 55-65

UNIT PACKAGE: 25



4446
(4872948)

Trunk Lid Bumper
GM

UNIT PACKAGE: 25



4264
(4564974)

Front Door Bumper
GM

UNIT PACKAGE: 25



4441
(4565591,
7637192,
20376243)

Front Door Bumper
GM

UNIT PACKAGE: 25



4357
(C60Z-16758-A)

Hood to Fender Bumper
Ford

UNIT PACKAGE: 25



4233
(3655015)

General Purpose
GM

UNIT PACKAGE: 25



4273
(B7A-16758-A)

Hood Bumper
Ford

UNIT PACKAGE: 25



4369
(3900684,
15029828)

Pillar Bumper
GM Trucks

UNIT PACKAGE: 25



4249
(1304225)

General Purpose
GM

UNIT PACKAGE: 25



4250
(3693292)

Glove Box Door Bumper
GM

UNIT PACKAGE: 25



4155
(16758A)

General Purpose
Ford

UNIT PACKAGE: 25



4244
(972724)

General Purpose
Chrysler

UNIT PACKAGE: 25



4204
(4023030)

General Purpose
Ford & Chrysler

UNIT PACKAGE: 25



4240
(4563173,
4565415)

Door Bumper
GM

UNIT PACKAGE: 25



4236
(3689084)

General Purpose
GM

UNIT PACKAGE: 25

Sec. 16**RUBBER BUMPERS & GROMMETS**

(ILLUSTRATIONS ACTUAL SIZE)

**4281**
(4721222)Trunk Lid Bumper
GM

UNIT PACKAGE: 25

**4266**
(3760155)Hood & Grille Bumper
GM

UNIT PACKAGE: 25

**19340**
(3538281)
RubberAir Inlet Screen
Rubber Retainer
Head Diameter: 1"
Stem Length: 5/16"
Fits Into 1/4" Hole
Cadillac DeVille,
Eldorado & Seville
1992-On

UNIT PACKAGE: 10

**20698**
Black RubberCigarette Lighter
Safety Plug
Used to replace unwanted
cigarette lighters.
Prevents accidental shocks
and burns.
Discourages smoking in the car.
The tight fit deters removal.

UNIT PACKAGE: 2

**15453**
(472450, 12338034)Hood Bumper
GM X Cars 1980-On
Across The Flats: 1"
Diameter: 15/16"
Overall Length: 1-29/32"

UNIT PACKAGE: 10

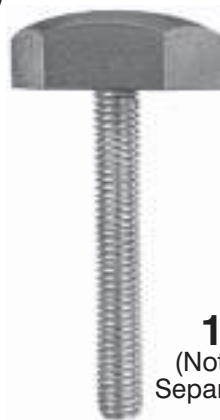
**16850**
(Not Supplied
Separately By O.E.M.)
ZincHood Adjustment Bumper
Ford 1989-On
M6-1.0 x 44mm
23mm Hex

UNIT PACKAGE: 5

**4474**
(400764, 400765)5/16-18 x 2-1/8"
Hood Adjusting Bolt & Bumper
GM

UNIT PACKAGE: 5

**16832**
(E83Z-16758-A)Hood Adjustment Nut & Bumper
Ford 1989-On

UNIT PACKAGE: 2 Sets

4473Same as 4474
except for packing

UNIT PACKAGE: 10

**16849**
(Not Supplied Separately By O.E.M.)
NylonHood Adjustment Nut
Ford 1989-On
M6-1.0 Threaded Insert

UNIT PACKAGE: 10

**Self-Adhesive
Bumpers**

Clear modified PVC material

**15984**Diameter: 1/2"
Height: 9/64"
Cylindrical Concavity

UNIT PACKAGE: 50

Rubber Caps (Special Heat Resistant EPDM Rubber)



Can be used for capping lines and hoses while testing carburetors, emission control systems, vacuum lines, etc.



Auveco Part No.	Fits Tube O.D.	Inside Length	Unit Pkg.
12209	1/8"	9/16"	25
4440	3/16"	9/16"	25
16264			100
19000	3/16"	1-1/4"	25
4439	1/4"	9/16"	25
19001	1/4"	1-1/4"	25

Auveco Part No.	Fits Tube O.D.	Inside Length	Unit Pkg.
19002	5/16"	9/16"	25
12907	5/16"	1-1/4"	25
12210	3/8"	31/32"	25
19003	3/8"	1-1/2"	25
12908	1/2"	11/16"	10

Vinyl Vacuum Caps



Can be used for capping lines and hoses while testing carburetors, emission control systems, vacuum lines, etc. Color coded for size identification.

Auveco Part No.	I.D.	Fits Tube O.D.	Color	Length	Unit Pkg.
18202	1/8"	3/16"	Blue	5/8"	50
18203	3/16"	1/4"	Red	5/8"	50
18204	1/4"	5/16"	White	5/8"	50
18205	5/16"	3/8"	Black	5/8"	50

Rubber Hold Down Straps With Hooks



Auveco Part No.	Length	Span Range	Unit Pkg.
4448	9"	15" to 20"	10
4449	15"	20" to 30"	10
4450	20"	30" to 40"	10
4451	31"	40" to 55"	10



11298 Galvanized

3/16" x 3" - "S" Hook
Used with Auveco Rubber Hold Down Straps No. 4448, 4449, 4450 and 4451

UNIT PACKAGE: 50

11299

Same As 11298
Except For Packing

UNIT PACKAGE: 100



SEALS AND CHANNELS DOOR SEALS

Years	Vehicle	Application	O.E.M. Number	Auveco Part No.
1991-73	Blazer, Jimmy & Suburban	Side Rear-Driver & Pass. Side	15606409, 15227654, 15227655	20792
1987-73	Pickup	Driver & Passenger Side	15606409, 15227654, 15227655	20792

WINDOW CHANNELS

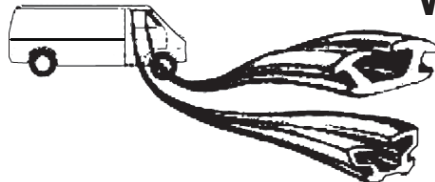

Years	Vehicle	Application	O.E.M. Number	Auveco Part No.
1991-73	Blazer, Jimmy & Suburban	Complete Glass Run with metal clip Front – Driver Side	14027777	20793
1991-73	Blazer, Jimmy & Suburban	Complete Glass Run with metal clip Front-Passenger Side	14027778	20794
1987-73	Pickup	Complete Glass Run with metal clip Front-Driver Side	14027777	20793
1987-73	Pickup	Complete Glass Run with metal clip Front-Passenger Side	14027778	20794



BELT WEATHERSTRIPS

Years	Vehicle	Application	O.E.M. Number	Auveco Part No.
1991-81	Blazer, Jimmy & Suburban	Inner-Driver Side	15569071	20797
1991-81	Blazer, Jimmy & Suburban	Inner-Passenger Side	15569072	20798
1991-73	Blazer, Jimmy & Suburban	Outer-Driver Side	14027775	20799
1991-73	Blazer, Jimmy & Suburban	Outer-Passenger Side	14027776	20800
1987-81	Pickup	Inner-Driver Side	15569071	20797
1987-81	Pickup	Inner-Passenger Side	15569072	20798
1987-73	Pickup	Outer-Driver Side	14027775	20799
1987-73	Pickup	Outer-Passenger Side	14027776	20800
1980-73	Pickup, Jimmy, Blazer & Suburban	Inner-Driver Side	470433	20795
1980-73	Pickup, Jimmy, Blazer & Suburban	Inner-Passenger Side	470434	20796



VENT WINDOW SEALS

Years	Vehicle	Application	O.E.M. Number	Auveco Part No.
1980-73	Pickup, Jimmy, Blazer & Suburban	Front Driver Side (Vertical sold separately)	6271903	20801
1980-73	Pickup, Jimmy, Blazer & Suburban	Front Passenger Side (Vertical sold separately)	6271904	20803
1980-73	Pickup, Jimmy, Blazer & Suburban	Rear Vertical-Driver Side	6271905	20802
1980-73	Pickup, Jimmy, Blazer & Suburban	Rear Vertical-Pass. Side	6271906	20804

GLASS SETTING CHANNELS

EPDM Dense Rubber



4511

For 1/8" Glass
 Height 11/32"
 Width at Base 1/4"
 Inside Base 1/8"

Glass Setting Channel
 UNIT PACKAGE: 50 Ft.



4515

For 1/4" Glass
 Height 9/16"
 Width at Base 25/64"
 Inside Base 1/4"

Glass Setting Channel
 UNIT PACKAGE: 50 Ft.



4588

For 1/4" Glass
 Height 9/16"
 Width at Base 7/16"
 Inside Base 1/4"

Windshield And Rear Window
 Glass Setting Channel
 UNIT PACKAGE: 50 Ft.



4512

For 3/16" Glass
 Height 7/16"
 Width at Base 27/64"
 Inside Base 3/16"

Windshield And Rear Window
 Glass Setting Channel
 UNIT PACKAGE: 50 Ft.



4513

For 1/4" Glass
 Height 7/16"
 Width at Base 31/64"
 Inside Base 1/4"

Windshield And Rear Window
 Glass Setting Channel
 UNIT PACKAGE: 50 Ft.



4516

For 3/16" Glass
 Height 7/16"
 Width at Base 3/8"
 Inside Base 3/16"

Glass Setting Channel
 UNIT PACKAGE: 50 Ft.



4670

For 1/4" Glass

Windshield & Rear
 Window Glass
 Setting Channel
 And Weatherstrip
 Ford, Mercury Early Models
 UNIT PACKAGE: 50 Ft.



4688

For 1/4" Glass

Rear Window Glass
 Setting Channel
 Chrysler Early Models
 UNIT PACKAGE: 50 Ft.



4671

For 1/4" Glass

Rear Window Glass
 Setting Channel
 And Weatherstrip
 Chrysler - Early Models
 UNIT PACKAGE: 50 Ft.

EPDM Rubber Weatherstrip For Glass



17509

Glass Thickness: 1/4"
Body Thickness: 1/16"
Self-Locking Type

UNIT PACKAGE: 50 Ft.



17513

Glass Thickness: 1/4"
Body Thickness: 1/8"
Bead Lock Type
Use With 17514

UNIT PACKAGE: 50 Ft.



17510

Glass Thickness: 1/4"
Body Thickness: 1/8"
Self-Locking Type

UNIT PACKAGE: 50 Ft.



17514

Glass Thickness 1/4"
Locking Bead
Use With 17513

UNIT PACKAGE: 50 Ft.

Molded Dense Rubber



Tee Rubber
Concave Head

- 4530.....3/4".....9/32" Head
- 4531.....1".....9/32" Head

UNIT PACKAGE: 50 Ft.
(One Size)



4581

Windshield glass weatherstrip for 1/4" glass

UNIT PACKAGE: 50 Ft.

Universal Windshield & Rear Window Flex-Fit Rubber Moulding

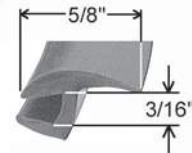

20342

A universal windshield rubber moulding for domestic and import vehicles. Made of EPDM rubber, this moulding contains a butyl bead that adheres to the glass during installation. The profile design allows for the moulding to attach easily to the glass edge and lay evenly on the vehicle body along straight areas and around corners. Extruded with a metal filament to prevent stretching and shrinkage.

UNIT PACKAGE: 15 Feet

(ILLUSTRATIONS ACTUAL SIZE)



18979

(3767196)

Windshield Setting Block
Lower Spacer
Chrysler Caravan, Voyager And
Town & Country
1984-On

UNIT PACKAGE: 15



20836

(4L3Z-1503296-AB)
Black Nylon

Windshield Setting Block
Ford Pick-Up Trucks
2004 - On

UNIT PACKAGE: 5



19817

Black Nylon

Universal Glass Setting Block
Width: 1-3/16"
Height: 7/16"
Length: 15/16"

UNIT PACKAGE: 25



21195

(15061964)
Black Nylon

Windshield Glass
Setting Block
With Adhesive Backing
Overall Length: 51mm
Buick Rainier; Cadillac Escalade;
Chevrolet Avalanche, Colorado,
Silverado, Suburban, Tahoe
& Trailblazer; GMC Canyon,
Envoy, Sierra & Yukon;
Hummer H2 & H3
Oldsmobile Bravada and Saab 9-7
1999 - On

UNIT PACKAGE: 10



19816

(55256967AC)
Black & Natural
Nylon

Windshield Glass
Adjustable Setting Block
NAGS Numbers: DW0999
& DW1295
Dodge Dakota & Durango
1997 - On

UNIT PACKAGE: 10



19818

Black Hard Rubber

Universal Glass Setting Block
Width: 1/2"
Height: 3/8"
Length: 2"

UNIT PACKAGE: 25



20942

(F6DZ-5403296-A)
Black Nylon

Windshield Setting Block
Width: 1-5/32"
Length: 1-1/8"
Height: 13/16"
Fits Into 9/32" Square Hole
Ford Sable & Taurus
1996 - On

UNIT PACKAGE: 10



3135

Window Regulator
Roller Assembly
Ford

UNIT PACKAGE: 25

GLASS SHOP SUPPLIES

(ILLUSTRATIONS ACTUAL SIZE)

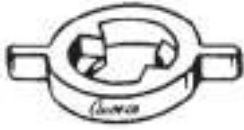

10843
(3696693)
Nylon

Front Door Glass Lift to
Stabilizer Bushing
Chrysler

UNIT PACKAGE: 50



1267
Lacquered

Inside Door Handle & Quarter
Regulator Handle Escutcheon
Tension Spring

UNIT PACKAGE: 25



21423
(BMW: 51321-938-884)
White Nylon

Window Regulator Guide
BMW 3 & 5 Series 1989 - On

UNIT PACKAGE: 2



2288
Zinc & Yellow

Door And Window Crank Handle
Retaining Clip
GM, Ford & Toyota

UNIT PACKAGE: 100



9886

Door And Window Crank Handle
Retaining Clip

UNIT PACKAGE: 100



2598
(353745-S)

Window Regulator Arm To Plate
Assembly Clip
Ford

UNIT PACKAGE: 100



11

Door And Window Crank Handle
Retaining Clip
Coppered Spring Steel
GM

UNIT PACKAGE: 100

GLASS SHOP SUPPLIES

(ILLUSTRATIONS ACTUAL SIZE)



16340
(54229-0201P)
Cadmium & Yellow
Window Crank Handle
Retaining Clip
Nissan
UNIT PACKAGE: 100



15813
(4005714)
Nylon
Window Glass Retainer
AMC Eagle 1988-On
UNIT PACKAGE: 25



9275
(7634583, 8734067)
Rear Window Reveal Moulding Clip
GM 1966-On
UNIT PACKAGE: 50



11152
(GM: 9731301;
AMC: 4005540)
White Nylon
Windshield to Panel (Lower) Side
Moulding Clip
GM 1975-On
AMC 1975-On
UNIT PACKAGE: 100



9633
(7698976)
Windshield Upper & Lower
Moulding Clip
GM 1967-On
UNIT PACKAGE: 100

10242

Same as 9275 except for packing
UNIT PACKAGE: 100



9639
(7693140)
Windshield, Skylight, Rear & Quarter
Window Reveal Moulding Clip
GM 1966-On
UNIT PACKAGE: 50



9749
(7730788)
Windshield, Skylight, Quarter & Rear
Window Reveal Moulding Clip
GM 1968-On
UNIT PACKAGE: 50



11066
(9624520)
Window Reveal Moulding Clip
GM 1973-On
UNIT PACKAGE: 50

**You Can E-mail
Your New Item
Suggestions To
mail@auveco.com**

**We Welcome All
Your Suggestions**



8583
(4533699)
Rear Window Reveal Moulding Clip
GM 1965-On
UNIT PACKAGE: 100



11067
(9606232, 9662950,
20603072)
Windshield & Rear Window
Reveal Moulding Clip
GM 1973-On
UNIT PACKAGE: 100

(ILLUSTRATIONS ACTUAL SIZE)



10243
(8717859)

Rear Window Reveal Moulding Clip
GM 1969-On

UNIT PACKAGE: 100



10631
(9854717)

Windshield Reveal Moulding Clip
GM 1970-On

UNIT PACKAGE: 50



20232
(10287926)
Yellow Nylon

Front & Rear Door
Window Moulding Clip
Overall Length: 1-9/16"
Buick Century & Regal
And Oldsmobile Intrigue
1997 - On

UNIT PACKAGE: 25

Remember....
All Items In This
Catalog
Are Available In
Bulk Quantities.
Call For a Quote



11345
(1654047)
Nylon

Windshield & Rear Window Reveal
Moulding Clip
GM 1974-On

UNIT PACKAGE: 100



17355
(GM: 94467458;
Isuzu: 8944674584)
Nylon

Windshield Reveal Moulding Clip
Geo Storm
1992-On

UNIT PACKAGE: 10



10701
(9895598)

Windshield Reveal Moulding Clip
GM 1971-On

UNIT PACKAGE: 50



12135
(20169887)
Nylon

Windshield Reveal
Moulding Clip
GM 1979-On

UNIT PACKAGE: 50



20263
(22599312)
Black Nylon

Front & Rear Door
Window Moulding Clip
Chevrolet Malibu, Oldsmobile
Achieva & Cutlass
1997 - On

UNIT PACKAGE: 25



10630
(9808241)

Windshield & Rear Window Reveal
Moulding Clip
GM 1970-On

UNIT PACKAGE: 50



11152
(GM: 9731301;
AMC: 4005540)
White Nylon

Windshield to Panel (Lower) Side
Moulding Clip
GM 1975-On
AMC 1975-On

UNIT PACKAGE: 100



2628
(4657731)

Windshield & Rear
Window Reveal Moulding Fastener
GM

UNIT PACKAGE: 100

GLASS SHOP SUPPLIES

(ILLUSTRATIONS ACTUAL SIZE)

Sec. 17



20276
(6003409,
6003752)

Windshield & Rear Window
Reveal Moulding Clip
Chrysler 1974 - On
Replaces Auveco 11177 & 13569

UNIT PACKAGE: 25



9353
(C6AB-6242413-A)

Rear Window
Reveal Moulding Clip
Ford 1967-On

UNIT PACKAGE: 100



17290
(B092-5-609)
Nylon

Rear Window Moulding Clip
MX6 1988-On
Ford Probe 1988-On
Mercury Tracer 1987-On

UNIT PACKAGE: 15



10622
(6002893)

Rear Window Reveal Moulding Clip
Chrysler 1971-On

UNIT PACKAGE: 50



8941
(C5ZZ-6543413-B)

Windshield &
Rear Window
Reveal Moulding Clip
Ford 1966-On

UNIT PACKAGE: 100



21526
(Not Available From O.E.M.)
White Nylon

Windshield Moulding Clip
Head Size: 14.5mm x 30mm
Bottom Leg Width: 26mm
Ford Flex 2009 - On

UNIT PACKAGE: 25



17151
(6004036)
Nylon

Window Reveal Moulding Clip
Chrysler LeBaron & Maserati
1987-On

UNIT PACKAGE: 15



13564
(E3SB-6342413-AB)

Windshield & Backlite
Reveal Moulding Clip
Ford 1983-On

UNIT PACKAGE: 50



10625
(D0DZ-6203174-C)

Windshield and Rear Window
Reveal Moulding Clip
Ford 1969-On

UNIT PACKAGE: 50



9882
(C8AZ-63642413-A,
D1AZ-6542413-B,
D1AB-6542413-AB)

Windshield & Rear Window Reveal
Moulding Clip
Ford 1968-On

UNIT PACKAGE: 100

For the most recent information
on new items
available from Auveco, refer to the
"Hot New Items" section of the
Auveco web site (www.auveco.com)



20424

(Not Available From O.E.M.)
White Nylon

Front Door Window Guide
Overall Length: 1-13/32"
Buick Electra, Park Ave. & Skylark;
Chevrolet Malibu; Oldsmobile
Achieva, Alero, Cutlass &
98 Regency And Pontiac Grand Am
1985 - On

UNIT PACKAGE: 5

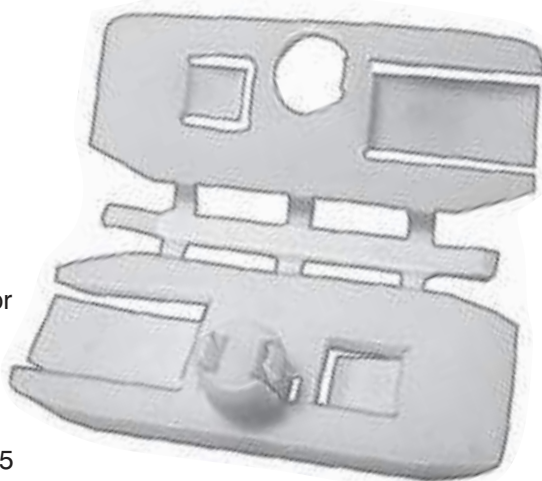

19397

(21098967)
Nylon

Front & Rear Door
Window Guide
Saturn Sedan &
Wagon
1996 - On

UNIT PACKAGE: 5



21022

(4339372)
Black Nylon

Window Guide
With Rivets
Chrysler Acclaim,
GTS, Lancer, LeBaron,
Shadow, Spirit & Sundance
1989 - On

UNIT PACKAGE: 25



15463

(12353912, 20487630,
20712176)
Nylon

Front Door Window Guide
Front Of Glass (4mm Thick)
Buick Skylark & Somerset 1991-85
Chevrolet Lumina APV 1990-On
Olds Calais 1991-85
Olds Silhouette 1990-On
Pontiac Grand Am 1991-85
Pontiac Trans Sport 1990-On

UNIT PACKAGE: 15



15462

(20478733,
22539533)
Nylon

Front Door Window Guide
Rear Of Glass
Buick Skylark & Somerset 1991-85
Chevrolet Lumina APV 1990-On
Olds Calais 1991-85
Olds Silhouette 1990-On
Pontiac Grand Am 1991-85
Pontiac Trans Sport 1990-On

UNIT PACKAGE: 15



15464

(20477850)
Nylon

Rear Door Window Guide
Upper Part Of Glass
LeSabre & Electra Park Ave. 91-85
Cadillac Fleetwood & DeVille 93-85
Delta 88 & 98 Regency 91-85
Bonneville 1991-87

UNIT PACKAGE: 15

GLASS SHOP SUPPLIES

(ILLUSTRATIONS ACTUAL SIZE)



15466
(20160591)
Nylon

Front Door Window Guide
Upper Part Of Glass
LeSabre 90-80 & Electra 84-On;
Fleetwood Brougham &
DeVille 83-On; Impala &
Caprice 90-80 &
Cavalier 87; Delta 88 & Custom
Cruiser 90-80 & 98 Regency 84-80;
Parisienne & Safari 89-81 &
Sunbird 87

UNIT PACKAGE: 25



15467
(10051034, 20123070,
20328600)
Nylon

Front & Rear Door Window Guide
Electra, Estate Wagon, LeSabre &
Skylark; DeVille; Impala Wagon,
Caprice & Citation; Delta 88, Custom
Cruiser, 98 Regency & Omega;
Catalina, Safari & Phoenix 81-80

UNIT PACKAGE: 25



Not Actual
Size

17159
(20747509)
Nylon

Front Door Window Guide
Rear Of Glass
Buick Electra & LeSabre
Cadillac Fleetwood/DeVille
Olds Delta & Regency
Pontiac Bonneville
1985-On

UNIT PACKAGE: 15



Not Actual
Size

17341
(12337898, 20747508)
Nylon

Front Door Window Guide
Front Of Glass
Buick Electra, LeSabre & Park Ave.,
Cadillac Fleetwood & DeVille, Olds
88 Royal & 98 Regency, Pontiac
Bonneville 1985-On

UNIT PACKAGE: 15



Not Actual
Size

19819
(10274778)
Black Nylon

Front Side Door Window Guide
Chevrolet Venture APV,
Oldsmobile Silhouette APV,
Pontiac Montana &
Trans Sport APV
1997 - On

UNIT PACKAGE: 10



17455
(20493450)
Nylon

Rear Door Window Guide
Upper Glass
Chevrolet Corsica
1987-On

UNIT PACKAGE: 15



17176
(20162174, 22543363)
Nylon

Front Door Window Guide
Buick Skyhawk, Cadillac Cimmaron,
Chevrolet Cavalier, Olds Firenza &
Pontiac Sunbird
1982-On

UNIT PACKAGE: 25

Not Actual
Size



18113
(69951-12180)
Nylon With
Steel Treaded Insert

Glass Mount
M6-1.0 Thread
Nissan, Ford & Imports

UNIT PACKAGE: 5



19393

(F1TZ-17698A)

Rear View Mirror Bracket
(Windshield Mounted)
NAGS number DW 1256, 1099

1169 & 1170

Fits Ford Mirrors

F0TZ-17700-A

& F7AZ-17700-A on

Ford & L-M Continental,
Contour, Escort, Mustang, Mystique,
Sable, Taurus & Tracer
1991-On

UNIT PACKAGE: 10



19394

(20626174)

Rear View Mirror Bracket
(Windshield Mounted)

NAGS number 1168, 1191, 1192,
1193, 1194, 1195, 1265,
1288 & 1299

GM

1987-On

UNIT PACKAGE: 10



19498

Black Nylon

Rear View Mirror Adapter Bracket

This adapter bracket allows you to
reuse the original mirror when a
windshield is replaced. If the new
windshield comes with a steel
mirror button attached, this adapter
fits over the button. Then the
original mirror can be fitted
onto the bracket.

GM & Chrysler

1981-On

UNIT PACKAGE: 3



19280

Black Nylon

Door Window Glass
To Regulator Nut
Ford Contour & Mystique
1995-On

UNIT PACKAGE: 5

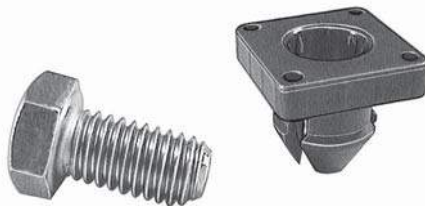

19281

(F5RZ-5421416B)

Door Window Glass
To Regulator Fastener
Assembly
3/8"-16 x 3/4" Grade 8 Cap Screw
Ford Contour & Mystique
1995-On

UNIT PACKAGE: 2 Sets



20309

(5008055AA)

Natural Nylon

Window To Regulator Grommet
Screw Size: #14 (M6.3)
Overall Length: 57mm
Stem Length: 10mm
Fits Into 13mm Hole
Dodge Neon
2000 - On

UNIT PACKAGE: 15



17073

(20085729)

Nylon

Window Regulator Drive Block
Used With Window
Regulator Tape
GM 1980-On

UNIT PACKAGE: 25



Piano Wire

For Cutting Through Sealant
On Windshields Without Gaskets
Solid Not Braided Wire

16959

1/4 Pound (approx. 160 Ft.)
.025" Wire Diameter

UNIT PACKAGE: 1 Roll

HELPFUL HINTS.....

FOR USING THE Auveco Catalog

1. The color-coded pages signify various sections:
Blue-Metric Items
Beige-Electrical Accessories
Green-Assortments, Cabinets, Bins & Racks
Gray-Key Blanks & Accessories
Pink-Import Car Body Hardware
2. Most pictures are actual size. You should be able to set a part on top of the picture to positively identify it.
3. Our Display Boards, which are shown on the color pages in the front of the catalog, are a great aid in identifying product.
4. We have three different indexes in the front of the catalog to assist you.
Pictorial Quick Index
Alphabetical Index
Numerical Index
5. There are two OEM Part Number To Auveco Part Number Cross References at the back of the catalog.

Window Lift Motor Gear Kits



18947
 Power Window
 Regulator Gear & Rollers
 62 Splines
 Ford 1989-On
 UNIT PACKAGE: 1



Not Actual Size
17974
 (D0AZ-62234A24)
 Power Window
 Regulator Gear
 9 Tooth
 45 Splines
 Ford 1964-On
 UNIT PACKAGE: 1



19786
 (Not Available From O.E.M.)
 Natural Nylon
 Torque Pin Kit
 For Window Regulator Gear
 Pin Diameter: 1/2"
 Pin Length: 13/32"
 Ford
 1964 - On
 UNIT PACKAGE: 15

O.E.M. POWER WINDOW LIFT MOTOR

Original Equipment



Not Actual Size
19071
 (E1VY-6623394-A)
 Lincoln 1981-80
 Lincoln Continental 1987-84
 Lincoln Town Car 1989-82
 Mark Series 1983-80
 UNIT PACKAGE: 1

Sec. 18

AIR CONDITIONING & HEATER FAN MOTORS Original Equipment



Not Actual Size

19081
(D8UZ-19805-A)

Ford: E100/350 Econoline
Van 1991-88

UNIT PACKAGE: 1

OEM ELECTRIC RADIATOR COOLING FAN MOTORS Original Equipment



Not Actual Size

19085
(22098790)

GM 1993-82

UNIT PACKAGE: 1



Not Actual Size

19086

Ford: Escort & Mustang
1990-87
LTD 1983
Tempo 1990-84
Thunderbird
1988-84

Mercury:
Capri 1986
Cougar 1986-84
Lynx 1987-86
Topaz 1990-84
Tracer 1990-89

UNIT PACKAGE: 1

MOTOR SPECIFICATION CHART (12 Volts)

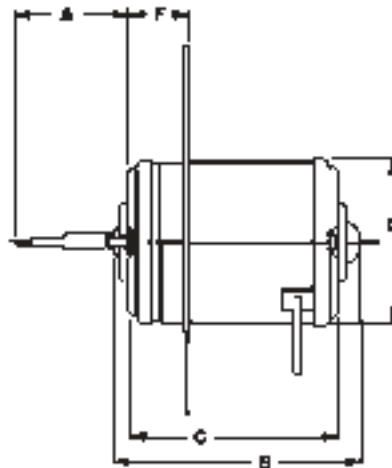
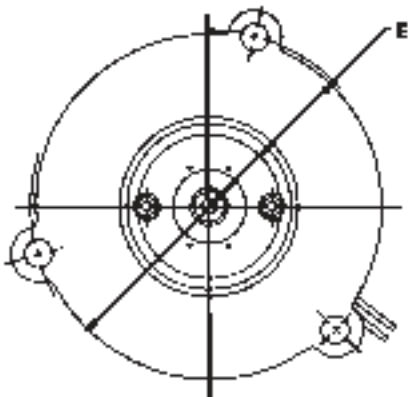

- A = Shaft extension from face
- B = Overall motor length
- C = Case mounting face to mounting face
- D = Outside motor diameter
- E = Mounting hole center to center
- F = Case mounting face to mounting flange

Auveco Part No.	Dia	Shaft Rotation	A	B	C	D	E	F	Motor Type
190815/16"Reversible	...1-7/16"	...4-7/16"3-11/16"3-1/4"Varies13/16"Ford Heater
190858mmC.W.S.E.1/2"4-1/8"3-3/8"3-1/4"Varies1-9/16"GM Rad. Fan
190865/16"Reversible1"4-1/2"3-3/4"3-1/4"4-7/8"7/16"Ford Rad. Fan Fl. Mtg.

C.W.S.E.-Clockwise Shaft End

HORNS

O.E.M. Replacement Horns



Not Actual Size

19017

Domestic Vehicles
Low Note

UNIT PACKAGE: 1



Not Actual Size

19018

Domestic Vehicles
High Note

UNIT PACKAGE: 1



Not Actual Size

19019

Import Vehicles
Low Note

UNIT PACKAGE: 1



Not Actual Size

19020

Import Vehicles
High Note

UNIT PACKAGE: 1

Auveco Part No.	Terminals	Frequency (Hz)	Decibel Rating At 4"	Current Draw (Amps)	Power Source (Volts)
19017	one/two	400	125	6	12
19018	one/two	500	125	6	12
19019	one/two	340	130	5	12
19020	one/two	425	130	5	12

Freeway Blaster Horns ("Big Rig" Sound)



Not Actual Size

19021
Low Note

UNIT PACKAGE: 1



Not Actual Size

19022
High Note

UNIT PACKAGE: 1

Auveco Part No.	Terminals	Frequency (Hz)	Decibel Rating At 4"	Current Draw (Amps)	Power Source (Volts)
19021	one/two	400	130	6	12
19022	one/two	500	130	6	12

Riviera Air Horns & Compressor Kit



Not Actual Size

19023

The Riviera air-powered dual horns sound simultaneously and have the "European" sound. Comes complete with a 12 volt compressor, relay, tubing and mounting hardware.

UNIT PACKAGE: 1 Set



Not Actual Size

19024
Horn Relay
12 Volt

UNIT PACKAGE: 1

Year	Make & Model	Original Equipment Replacement	Freeway Blaster (Optional)	Year	Make & Model	Original Equipment Replacement	Freeway Blaster (Optional)
ACURA				LEXUS			
12-90	All Models	*19022 & 19021		12-90	All Models		
AMC				LINCOLN-MERCURY			
90-79	Alliance, Encore, Talon	19019 & 19020	19022 & 19021	12-74	All Other Models	19022 & 19021	
90-74	All Other Models	19018 & 19017	19022 & 19021	99-71	Capri & Capri II	*19020	*19022
AUDI				99-71	Bobcat, Lynx, Zephyr Tracer, Mystique, Topaz	*19018	*19022
12-73	All Models	*19018	*19022	MAZDA			
BMW				12-91	Navajo	19018 & 19017	19022 & 19021
12-95	5, 7, & 9 Models	19018 & 19017	19022 & 19021	12-75	All Other Models	19019 & 19020	19022 & 19021
12-74	All Other Models	19019 & 19020	19022 & 19021	12-71	RX-2, RX-3, Mizer, MX-3, MX-5, Protege, GLC Waqon, B2200, B2601	*19020	*19022
BUICK				MAZDA TRUCK			
12-86	All Other Models	19022 & 19021		12-78	All Models	*19019	*19021
96-75	Skvhawk & Skvlark	*19018	*19022	MERCEDES			
CADILLAC				12-73	All Models	19022 & 19021	
12-75	All Other Models	19022 & 19021		MITSUBISHI			
83-81	Cimarron	*19018	*19022	12-83	All Models	19019 & 19020	19022 & 19021
CHEVROLET				NISSAN			
12-76	Aveo, Beretta, Cavalier, Celebrity, Chevette, Citation, Corsica, Spectrum, Sprint & Nova	*19018	*19022	12-97	All Models	19018 & 19017	19022 & 19021
12-71	Corvette	19022 & 19021		96-74	All Other Models	19019 & 19020	19022 & 19021
12-71	All Other Models	19018 & 19017	19022 & 19021	90-87	Pulsar	*19020	19022
CHEVROLET LIGHT DUTY TRUCKS & VANS				NISSAN TRUCK			
12-75	S-10	19018 & 19017	19022 & 19021	12-93	Quest	19018 & 19017	19022 & 19021
12-75	All Other Models	19022 & 19021		12-82	All Other Models	19019	*19021
CHRYSLER				OLDSMOBILE			
12-77	All Other Models	19018 & 19017	19022 & 19021	04-91	Bravada	*19017	*19021
10-95	Sebring	19019 & 19020	19022 & 19021	04-98	Alero	19018 & 19017	19022 & 19021
97-87	LeBaron & GTS	19018	*19021	04-74	All Other Models	19022 & 19021	*19021
DODGE				89-88	Firenza	19018	19022
12-74	All Other Models	19018 & 19017	19022 & 19021	PLYMOUTH			
05-95	Neon	*19020	*19022	01-75	All Other Models	*19018	*19022
99-87	Charger, Lancer, Omni, Shadow, Spirit	*19018	*19022	89-71	Arrow, Champ, Colt, Laser	*19020	*19022
98-74	Challenger, Colt	*19020	*19022	PLYMOUTH TRUCKS & VANS			
DODGE LIGHT DUTY TRUCKS & VANS				01-74	All Models	*19017	*19021
12-87	Dakota, Ram, Pickup, Caravan	*19021		PONTIAC			
12-75	All Other Models	19022 & 19021		10-95	TransSport Montana	19018 & 19017	19022 & 19021
FORD				10-75	All Other Models	19018 & 19017	19022 & 19021
12-07	Edge	19018 & 19017	19022 & 19021	94-93	TransSport	*19017	*19021
12-01	Escape	19018 & 19017	19022 & 19021	94-82	Astre, J-2000, T-1000, Lemans, Sunbird	19019	*19021
12-71	Escort, Fairmont, Festiva, Focus, Maverick Mustang II, Pinto, Tempo, Contour	*19018	*19022	87-84	Fiero	19019 & 19020	19022 & 19021
12-70	All Other Models	19022 & 19021		PORSCHE			
97-77	Fiesta	19020	19022	12-70	All Models	19018 & 19017	19022 & 19021
FORD LIGHT DUTY TRUCKS & VANS				RANGE ROVER			
12-85	All Other Models	19022 & 19021		12-01	All Models	19022 & 19021	
90-75	Ranger, E 150/350 Vans, Aerostar, Economize	*19022		SAAB			
GEO				12-79	All Models	19019 & 19020	19022 & 19021
12-90	All Other Models	*19019	*19021	SATURN			
99-90	Storm	19019 & 19020	19022 & 19021	10-07	Outlook	19018 & 19017	19022 & 19021
GMC LIGHT DUTY TRUCKS & VANS				10-90	All Other Models	*19019	*19021
12-75	All Other Models	19018 & 19017	19022 & 19021	SUBARU			
92-91	Jimmv, Sonoma	*19021		12-78	All Other Models	19019 & 19020	19022 & 19021
HONDA				94-87	Justy, Samurai	*19019	*19021
12-80	Civic, Civic Del Sol	*19020	*19022	SUZUKI SUV			
12-73	All Other Models	19019 & 19020	19022 & 19021	12-88	All Models	*19019	*19021
HYUNDAI				TOYOTA			
12-86	All Other Models	19019 & 19020	19022 & 19021	12-91	Avalon, Camry	19018 & 19017	19022 & 19021
87-84	Ponv	19020	19022	12-80	Starlet, Tercel Sedan, Corolla Coupe, Sedan, Liftback	*19021	*19022
INFINITI				12-72	All Other Models	19018 & 19017	19022 & 19021
12-90	All Models	19022 & 19021		TOYOTA TRUCK			
ISUZU				12-81	Land Cruiser & Other Models	19022 & 19021	
12-83	Impulse, Stylus, Trooper	19019 & 19020	19022 & 19021	12-70	4-Runner, Pickup, Van, Paseo	*19020	*19022
12-81	I Mark, Amigo, Pickup, Rodeo	*19020	*19022	80-69	Land Cruiser	*19020	*19022
JAGUAR				VOLKSWAGEN			
12-72	All Models	19022	19021	12-80	Jetta, Quantum, Fox, Golf, Passat	19019 & 19020	19022 & 19021
JEEP				12-74	All Other Models	*19019	*19021
12-74	Cherokee, Grand Cherokee	19022 & 19021		VOLVO			
12-70	CJ, DJ, Scrambler, Wrangler		*19022	12-70	All Other Models	19019 & 19020	19022 & 19021
		*19018		97-84	240-740-760 Series	*19020	*19022

*One horn is standard; however, vehicle may be equipped with optional second horn for better sound. Add another horn of opposite note (high or low).

TRIMMING SUNDRIES & FASTENERS

Sec. 19

(ILLUSTRATIONS ACTUAL SIZE)



1720

Door And Quarter Trim
Panel Fastener.
Chrysler

UNIT PACKAGE: 100



8206

Door Trim
Panel Fastener:
Ford

UNIT PACKAGE: 100



9361

(Ford: 358470;
Chry: 1900654)

Door Trim Panel Fastener:
Ford & Chrysler

UNIT PACKAGE: 100



2385

Door Trim
Panel Fastener:
Chrysler

UNIT PACKAGE: 100



2310

Door Trim
Panel Fastener
Chrysler

UNIT PACKAGE: 100



2272

(358107)

Body Belt Moulding &
Hood Side Moulding Fastener:
Ford

UNIT PACKAGE: 100



2309

Door Trim Panel Fastener:
All Cars With .125 Panels
Ford

UNIT PACKAGE: 100



11863

(383033-S101)
Phosphate

Door Trim
Panel Fastener
Ford

UNIT PACKAGE: 50



1256

(353123)

Rear Quarter Strip
(Inside), Instrument
Panel Moulding & Hood
Side Moulding Fastener
Ford & Chrysler

UNIT PACKAGE: 50



11406

Trim Clip Fastener
Head Diameter: 1/2"
For 1/4" Hole

UNIT PACKAGE: 100



808

General Purpose:
Head Diameter: 1/2"
Chrysler

UNIT PACKAGE: 100



807

General Purpose:
Head Diameter: 1/2"
Chrysler

UNIT PACKAGE: 100

Remember....
All Items In This
Catalog
Are Available In Bulk
Quantities
Call For a Quote.

Sec. 19

TRIMMING SUNDRIES & FASTENERS



18402
Phosphate & Green
Weatherstrip Clip
GM
UNIT PACKAGE: 25



18395
Black Phosphate
Weatherstrip Clip
GM
UNIT PACKAGE: 50



19437
(6031551)
Red Oxide
Trim Panel Retainer
Chrysler Van
1997-On
UNIT PACKAGE: 25



12134
(4114785)
Zinc
Trim Panel Fastener
Fits Into 5/16" Hole
Chrysler
UNIT PACKAGE: 50



18352
Black Phosphate
Weatherstrip Clip
GM
UNIT PACKAGE: 25

BULK QUANTITIES

The items listed below are available in bulk quantities of 25,000 or more - Quotation On Request

A = Head O.D.
B = Prong Length
C = Hole Size
D = Width of Diamond



5961
Brown
General Purpose

A: 17/32"
B: 7/8"
C: 9/32"
D: 1/2"

UNIT PACKAGE: 100



1202
Sandstone
General Purpose

A: 17/32"
B: 1-17/64"
C: 9/32"
D: 7/16"

UNIT PACKAGE: 100

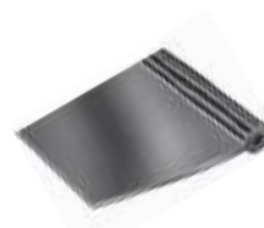

V-875
Fender Welt

1-3/8 inch (3/16" Bead)
Bright Smooth Vinyl Bead

UNIT PACKAGE: 50 FEET

Footman Loops

Auveco Part No.	Size	Hole Size	Hole Ctr. To Hole Ctr.	Overall Length	Unit Pkg.
-----------------	------	-----------	------------------------	----------------	-----------

Steel-Nickel Plated

7771	For 1" Strap	7/32"	2-1/8"	2-5/8"	25
7772	For 1-1/4" Strap	1/4"	2-1/4"	2-3/4"	25
7773	For 1-1/2" Strap	1/4"	2-5/8"	3-1/8"	25
19401	For 2" Strap	1/4"	3-1/8"	3-21/32"	25

Steel - Black "E" - Coat Plated (168 Hrs. Salt Spray)

19403	For 1-1/4" Strap	1/4"	2-1/4"	2-3/4"	25
19404	For 1-1/2" Strap	1/4"	2-5/8"	3-1/8"	25

Steel - Zinc Plated

19848	For 2" Strap	1/4"	3-1/8"	3-21/32"	25
-------	--------------	------	--------	----------	----



TRIMMING SUNDRIES & FASTENERS

Sec. 19

(ILLUSTRATIONS ACTUAL SIZE)

Hog Rings



7595

Medium
.080" Wire Dia.

To attach seat covers to cushions
and seat bottoms - also cushion spring clips

UNIT PACKAGE: 500 (One Size)



7644

Large
.088" Wire Dia.



9921

(4851794)

1-1/8" Diameter
Seat Back Button Retainer
GM 1962-On

UNIT PACKAGE: 25



9417

Snap-On Trim Clip
Panel Range: .105"-.115"

UNIT PACKAGE: 100



11795

Zinc

Seat Cover Clip
GM 1978-On

UNIT PACKAGE: 100



9416

Snap-On Trim Clip
Panel Range: .060"-.090"

UNIT PACKAGE: 100

2850



Front Seat
Self-Locking Clip
Ford

UNIT PACKAGE: 100



12671

3/4" Nail
(.750)

Replaces 7585
"Nail On" Door Panel Repair Clip
Slips On Door Panel Fastener Strip
For Repairs To Replace Broken
Nails In Panel Edging.
GM

UNIT PACKAGE: 50



7578

Seat Cushion Upholstery Clip
Can be used to repair
drooping headliners in Honda.

UNIT PACKAGE: 500



8665

Front Seat
Rod End Nut:
O.D. 15/16"
Stud Size 1/2"
Chrysler

UNIT PACKAGE: 100



12069

(416629)
Zinc

Upholstery Clips
GM 1979-On

UNIT PACKAGE: 50



7707

Cloth Lined
Cushion Spring Clip
To Fasten Springs To Each Other
Or To Border Wire. 7/8" Long. For
1/4" Or Two 8 Gauge Wires.

UNIT PACKAGE: 100



8719

(4000155)
Nickel

Front Seat Inner Bracket Nut
O.D.: 11/16", Stud Size: 3/8"
Rambler

UNIT PACKAGE: 100



2672

Front Seat
Hinge Arm Clip
GM

UNIT PACKAGE: 100

(ILLUSTRATIONS ACTUAL SIZE)



**Grommets And Washers
Solid Brass**

- 7347.....3/8" Hole(Size No. 2)
- 7348.....7/16" Hole(Size No. 3)
- 7349.....1/2" Hole(Size No. 4)
- 7350.....5/8" Hole(Size No. 5)

NOTE: Washers placed in a bag separate from grommets.

UNIT PACKAGE: 144 Grommets & 144 Washers

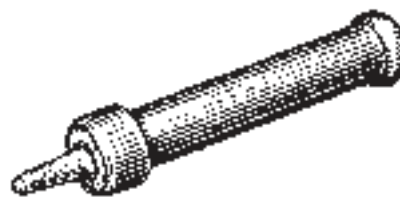

Grommet Setting Dies

- 7340 (9/32" Hole-Size No. 1)
- 7341-For Grommet 7347 (3/8" Hole-Size No. 2)
- 7342-For Grommet 7348 (7/16" Hole-Size No. 3)
- 7343-For Grommet 7349 (1/2" Hole-Size No. 4)
- 7344-For Grommet 7350 (5/8" Hole-Size No. 5)

UNIT PACKAGE ONE SET

Countersunk Type Washers



Nickel Plated Brass

Black Zinc

Plain Brass

Screw Size	I.D.	O.D.	Nickel Plated Brass			Black Zinc Plated Brass		Plain Brass	
			Unit Pkg. 100	Unit Pkg. 144	Unit Pkg. 1000	Part No.	Unit Pkg.	Part No.	Unit Pkg.
#4.....	9/64"	3/8"	612		7613				
#6.....	11/64"	7/16"	614	7143	7615	16011	100		
#8.....	13/64"	1/2"	616	7145	7616	16012	100		
#10.....	1/4"	19/32"	618	7147	7618	16013	100	16593	100
#12.....	9/32"	11/16"	619	7148					
#14.....	5/16"	25/32"	21389						

**Flanged Type
Countersunk Washers**



Screw Size	I.D.	O.D.	Nickel On Brass Part No.	Black Zinc On Brass Part No.	Stainless Steel Part No.	Unit Pkg.
#6.....	5/32"	1/2"	3469		3470	100
#8.....	13/64"	5/8"	2515	16009	2597	100
#10.....	1/4"	11/16"	3471		3472	100

**Flush Type Washers
Nickel Plated On Brass**



Unit Pkg. 100	Unit Pkg. 144	Unit Pkg. 1000	Screw Size	I.D.	O.D.
602	7137	7624	#6	5/32"	11/32"
604	7138	7625	#8	3/16"	3/8"
16015		16016	#10	13/64"	15/32"

(ILLUSTRATIONS ACTUAL SIZE)

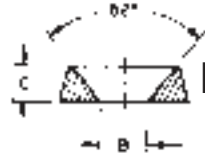
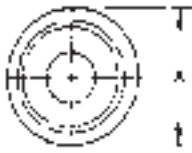

Nylon Finishing Washers



Available in natural or black nylon, these molded washers protect cabinets from scratching, cover misaligned holes, etc. May also be used as guides, bumpers and spacers.

Auveco Part No.	Screw Size	O.D. (A)	I.D. (B)	Thickness (C)	Color	Unit Pkg.
13717	#6	.437"(11.10mm)	.143"(3.63mm)	.100"(2.54mm)	Black	50
13718	#8	.515"(13.08mm)	.171"(4.34mm)	.115"(2.92mm)	Natural	50
13719	#8	.515"(13.08mm)	.171"(4.34mm)	.115"(2.92mm)	Black	50
13720	#10	.580"(14.73mm)	.191"(4.85mm)	.152"(3.86mm)	Natural	50
13721	#10	.580"(14.73mm)	.191"(4.85mm)	.152"(3.86mm)	Black	50
13723	#12	.609"(15.47mm)	.225"(5.72mm)	.160"(4.06mm)	Black	50
13724	#14	.683"(17.35mm)	.251"(6.38mm)	.183"(4.65mm)	Natural	50
13725	#14	.683"(17.35mm)	.251"(6.38mm)	.183"(4.65mm)	Black	50

Pop on Screw Covers & Bases



Covers-Matte Finish

Ultra Violet Stabilized Polypropylene covers and bases help shield screws from corrosive environments. Their smooth finish forms a protective barrier against rough-edges.

For use with flat head and oval head tapping screws and round head machine screws.

They're simple to use:

1. Place washer over pilot or starting hole for screw, nail or rivet.
2. Install fastener
3. Place Snap Cap over washer
At slight angle.
4. Simply push Snap Cap down firmly.

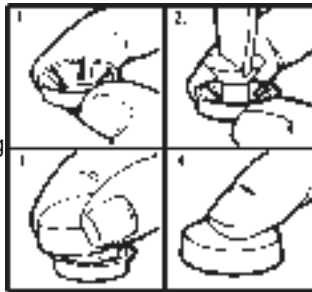

Screw Cover Bases			Screw Covers		
Auveco Part No.	Unit Pkg.	Screw Size	Auveco Part No.	Unit Pkg.	Color
13839	50	#4	13831*	50	Black
			13832*	50	White
13840	50	#6	13833*	50	Black
			13834*	50	White
13841	50	#8	13835•	50	Black
			13836•	50	White
13842	50	#10	13837•	50	Black
			13838•	50	White

* 1/2" O.D.

• 5/8" O.D.

Accessories For Use On Landau Tops



19413

(F7UZ-15238A32)
Black Nylon

Door Panel Screw Cover
Head Diameter:
3/4" (19mm)
Fits Into 5/8" (16mm) Hole
Ford Econoline E150
1997-On

UNIT PACKAGE: 25



9877

Stainless Steel

#4-24 x 3/8"
7/32" Head Diameter
Type AB
Used In Place Of
Welded Studs
On Landau Tops.

UNIT PACKAGE: 100



9850

(7731589)
Natural Nylon

Landau Top Moulding Clip
Use With Auveco Screw
9877

UNIT PACKAGE: 100



10632

Nylon

Landau Top Moulding Clip
Use With Auveco
Screw 9877

UNIT PACKAGE: 100

Sec. 19**TRIMMING SUNDRIES & FASTENERS****11485**
(1729250)
NylonRoof Transverse Moulding Clip
GM 1976-On

UNIT PACKAGE: 25

**9342**
(4459049)
NylonDoor Trim Pad
Grommet
#8 or #10
Screw Size
Stem Length: 9/16"
Buick & Oldsmobile

UNIT PACKAGE: 50

**3617**
(6280765)
NylonDoor Trim Pad
Grommet
#4 Screw Size
Stem Length: 7/16"
Chevrolet &
Oldsmobile

UNIT PACKAGE: 100

**18398**
(20058837)
NylonWindshield Upper
Garnish Clip
GM A & G Models
1988-78

UNIT PACKAGE: 10

**16865**
(20462090)
NylonGarnish Moulding Clip
Buick Century & Regal,
Chevrolet Camaro, Celebrity,
Monte Carlo & Malibu, Oldsmobile
Cutlass & Ciera, Pontiac Firebird
Grand Prix & 6000 1978-On

UNIT PACKAGE: 25

**11118**
(9617200)
NylonHeadliner Clip
Inner Side Front, Center & Rear
GM 1973-On

UNIT PACKAGE: 10

11119Same As 11118
Except For Packing

UNIT PACKAGE: 100

**17074**
(20007308)
NylonWindshield & Back
Window Garnish Clip
Buick Electra & LeSabre;
Cadillac DeVille & Fleetwood;
Chevrolet Caprice & Impala;
Oldsmobile 88 & 98 and
Pontiac Bonneville 1984-77

UNIT PACKAGE: 25

**17666**
(20632190)
NylonGarnish Moulding Clip
Back Window Upper & Side
Moulding Garnish
Buick LeSabre, Cadillac
Fleetwood Brougham,
Chevrolet Caprice &
Impala, Olds Delta 88 & 98,
Pontiac Bonneville & Parisienne
1989-80

UNIT PACKAGE: 10

SNAP FASTENERS



Button
Nickel on Brass
1 1/64" Barrel Length

14830 - Black Delrin Cap
UNIT PACKAGE: 50
7677 - Nickel Cap
UNIT PACKAGE: 100



Socket
Nickel on Brass

7678 - Normal Action
UNIT PACKAGE: 100



Stud
Nickel on Brass

7679 - Clinch Type
UNIT PACKAGE: 100



Eyelet
Nickel on Brass

7682 - 1/4" Barrel Length
UNIT PACKAGE: 100

Buttons 7677 and 14830 assemble with socket 7678. You can use hand tools 7690 and 7691 or handpress tool 14835 to complete this step. Stud 7679 assembles with eyelet 7682. You can use hand tools 7691 and 7692 or handpress tool 14835 to perform this step. The two assembled units then snap together. Also an assembled button (7677, 14830) and socket (7678) unit can be used with fasteners listed below.



Machine Screw
Nickel on Brass

7681 10-32" x 3/8"
UNIT PACKAGE: 100



Phillips Wood Screw
Nickel on Brass

9814 #8 x 3/8"
7680 #8 x 5/8"
UNIT PACKAGE: 100



Phillips Head
Stainless Steel Screw

14833 #8 x 3/8"
14834 #8 x 5/8"
15687 #10 x 5/8"
UNIT PACKAGE: 50



Phillips Head
Nickel on Brass

16418 #8 x 1/2"
16419 #8 x 3/4"
Stainless Steel Screw
UNIT PACKAGE: 25



Socket
Nickel on Brass

7683 7/32" Prongs. Assembles with clinch plate 7684. Snaps together with 7688.
UNIT PACKAGE: 100



Clinch Plate
Nickel on Brass

7684 Assembles with socket 7683.
UNIT PACKAGE: 100



Wood Screw Stud
Nickel on Brass

7688 #7 x 1/2" snaps together with socket 7683.
UNIT PACKAGE: 100

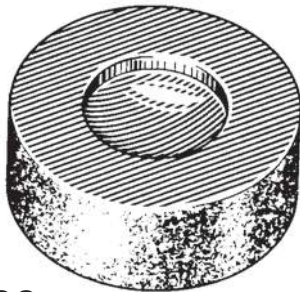

7690

Die for assembling buttons 7677 & 14830 with socket 7678. The button sets in the die. Then the material and socket are placed over the button barrel. Tool 7691 is used to swedge over the barrel. 5/8" high, 1-3/8" diameter.

UNIT PACKAGE: 1

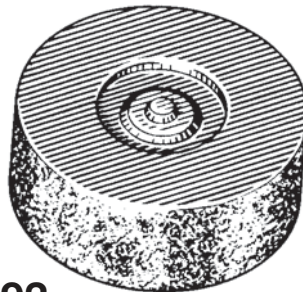

7692

Die for assembling stud 7679 and eyelet 7682. The eyelet sets in the die. Then the material and stud are placed over the eyelet barrel. Tool 7691 is used to swedge over the barrel. 5/8" high, 1-3/8" diameter.

UNIT PACKAGE: 1

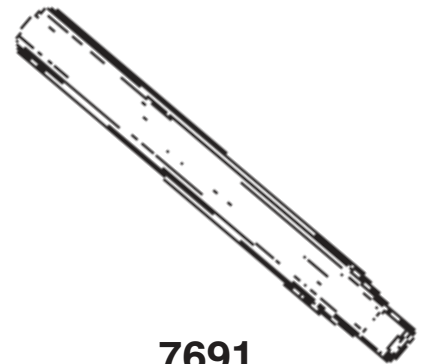

7691

Tool for assembling buttons 7677 & 14830 with socket 7678 and stud 7679 with eyelet 7682. 3-1/4" long.

UNIT PACKAGE: 1

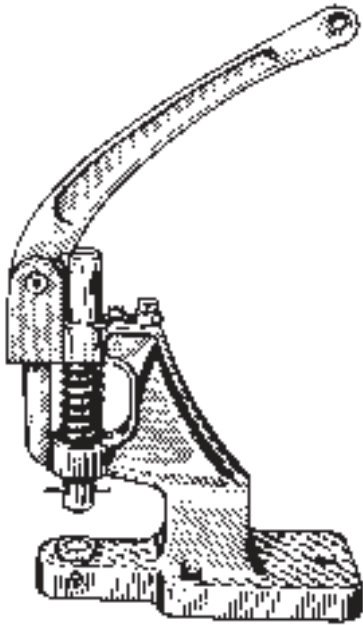

14835

Handpress tool for professional looking assembly of buttons 7677 & 14830 with socket 7678 and stud 7679 with eyelet 7682. Tool automatically punctures material. Buttons and eyelet sit on bottom dies. Socket and stud snap onto dies on the plunger. 13-1/2" x 8" x 3-1/2". Weighs 8 lbs.

UNIT PACKAGE: 1

Curtain Fasteners
Nickel On Brass



Backplate

7417

Single curtain to clinch with backplate

UNIT PACKAGE: 100



7419

Single curtain. Use with #4 stainless steel or chrome or brass screws (sold separately).

UNIT PACKAGE: 100



7409

Eyelets & washers. Use with 7417 and 7419 Fasteners.

UNIT PACKAGE: 100 Sets



7432

Tool for cutting holes in material when installing 7409 eyelet and washer. Overall Length: 6-11/16"

UNIT PACKAGE: 1

TRIMMING SUNDRIES & FASTENERS

Sec. 19

Refer to Retainer Specification Chart on pages 404 - 413



19746
(91652-SZ3-003)
White Nylon

Door Lining Retainer
Acura 3.5RL
1996 - On

UNIT PACKAGE: 10



18684
(10262036)
Black Nylon

Control Panel Trim Retainer
Chevrolet Lumina &
Monte Carlo 1995-On

UNIT PACKAGE: 100



21627

(67868-30030)
Black Nylon

Door & Roof Rail Retainer
Lexus 2006 - On &
Toyota 1974 - On

UNIT PACKAGE: 25



21458

(91567-S3M-000)
Black Nylon

Weatherstrip Retainer
Honda Accord, Civic &
Odyssey
2003 - On

UNIT PACKAGE: 25



19686

(90467-05045-22)
Black Nylon

Weatherstrip Retainer
Toyota Solara
1998 - On

UNIT PACKAGE: 25



21548
(67869-20030)
Black Nylon

Weatherstrip Retainer
Lexus IS 300 & SC 430 and
Toyota Camry, Celica,
Corolla, Highlander,
Matrix, MR-2, Prius, RAV-4,
Scion, Solara & Supra
1990 - On

UNIT PACKAGE: 25



14367
(9924-90-512B)
Black Nylon

Retainer
Mazda

UNIT PACKAGE: 50



18683
(10063599)
Black Nylon

Remote Control Door
Lock Receiver Retainer
Chevrolet Lumina
& Monte Carlo, Oldsmobile
Cutlass And Pontiac
Bonneville & Grand Prix
1991-On

UNIT PACKAGE: 100



18770
(3759944)
Black Nylon

Cowl & Dash Panel
Retainer
Dodge Shadow &
Plymouth Sundance
1988-On

UNIT PACKAGE: 50



14921
(GM: 20699808;
Chry: 6502328)
Black Nylon

Door Weatherstrip Retainer
GM 1974-On
Dodge Ram 1994-On

UNIT PACKAGE: 50



20165
(4658887)
Black Nylon

Trim Panel Retainer
Chrysler LH & LHS Series
1997 - On

UNIT PACKAGE: 50



20528
(24205245)
Black Nylon

Rear Bumper Cover
Retainer
Chevrolet Cavalier &
Pontiac Sunfire
1995 - On

UNIT PACKAGE: 50



11129
(2964547)
Black Nylon

Weatherstrip Retainer
Chrysler 1977-On

UNIT PACKAGE: 25



20344
(10169777)
Black Nylon

Weatherstrip Retainer
Replaces Auveco 18322
Chevrolet Impala, Lumina
& Monte Carlo And
Pontiac Aztek
1995 - On

UNIT PACKAGE: 25



18389
(25603960)
Black Nylon

Radiator Baffle Retainer
Olds 98 Regency
1994-On

UNIT PACKAGE: 25



14021
(N803170-S)
Black Nylon

Facia Retainer
Ford Mustang
& Capri 1984-On

UNIT PACKAGE: 25



11120
(8731909)
Black Nylon

Door Weatherstrip Retainer
GM 1963-On

UNIT PACKAGE: 100



18302
(GM: 20538173;
Chrys:
6104908-AA; Mercedes:
002-997-33-86-67)
Black Nylon

Weatherstrip Retainer
Buick Century & Riviera,
Chevrolet Lumina, Olds
Aurora & Regency and
Pontiac Grand Prix
1989-On
Chrysler 2008 - On
Mercedes-Benz

UNIT PACKAGE: 50



14006
(20455900)
Black Nylon

Moulding Retainer
GM 1984-On

UNIT PACKAGE: 25

Sec. 19

TRIMMING SUNDRIES & FASTENERS

Refer to Retainer Specification Chart on pages 404 - 413



21519
(01553-01A50)
Black Nylon

Bumper & Trim Retainer
Infiniti FX35, G35, G37,
M35, M45 & Q45 and
Nissan 350Z & 370Z
1997 - On

UNIT PACKAGE: 25



17634
(01553-01781)
Black Nylon

Cowl Grille Retainer
Nissan 240SX
1990 - On

UNIT PACKAGE: 25



20893
(GM: 10293193;
Ford: N811040-S)
Black Nylon

Hood Insulation &
Door Weatherstrip Retainer
Chevrolet Cobalt &
Ford Mustang
2005 - On

UNIT PACKAGE: 50



18298
(22536642)
Black Nylon

Rear Bumper
Fascia Retainer
Chevy Cavalier, Olds
Calais, Pontiac Grand Prix,
Sunbird & 6000
1988-On

UNIT PACKAGE: 50



19673
(72311-S10-003)
Black Nylon

Weatherstrip Retainer
Honda CRV
1997 - On

UNIT PACKAGE: 15



20311
(N803857S)
Black Nylon

Front End Fascia Retainer
Replaces Auveco 15483
Ford Aerostar, LTD
& Marquis
1985 - On

UNIT PACKAGE: 50



11721
(411700)
Black Nylon

Trim Panel Retainer
GM 1968-On

UNIT PACKAGE: 50



19149
(4658673)
Black Nylon

Weatherstrip Retainer
Front & Rear Doors
Chrysler Neon
1996-On

UNIT PACKAGE: 50



18948
(GM: 1644290; Nissan:
01553-0075U)
Black Nylon

Hood Insulation,
Rear Bumper Fascia
& Door Trim Plate Retainer
GM 1991-On
Nissan: 2002 - On

UNIT PACKAGE: 25



18897
(10078274)
Black Nylon

Side Roof Rail
Weatherstrip Retainer
Chevrolet Corsica & Beretta
1989-87

UNIT PACKAGE: 25



11680
(25016383)
Black Nylon

Dash Panel Retainer
GM 1977-On

UNIT PACKAGE: 50



11612
(GM: 20413107;
Ford: 388246S
AMC: 4006516)
Black Nylon

Weatherstrip Fastener
GM, Ford & AMC

UNIT PACKAGE: 50



14289
(90666-SA0-0030)
Black Nylon

Retainer
Honda

UNIT PACKAGE: 25



19836
(6505417AA)
Black Nylon

Trim Panel Retainer
Chrysler

UNIT PACKAGE: 50



12993
(7703-077-066)
Natural Nylon

Rear Window Moulding
AMC Renault & Alliance
1983-On

UNIT PACKAGE: 25



14017
(390126-S)
Black Nylon

Fascia Retainer
Ford Mustang & Capri
1984-On

UNIT PACKAGE: 25



18682
(10098645)
Black Nylon

Front Door Lower
Moulding Retainer
Pontiac Grand Prix
With Sport Performance
Package
1994-On

UNIT PACKAGE: 50



20256
(01553-01182)
Black Nylon

Splash Shield Retainer
Nissan Frontier Truck
1997 - On

UNIT PACKAGE: 50

TRIMMING SUNDRIES & FASTENERS

Sec. 19

Refer to Retainer Specification Chart on pages 404 - 413



17453

(B003-68-865-96)
Gray Nylon

Rear Compartment
Interior Trim Retainer
Ford Probe 1988-On
Mazda MX6 1988-On

UNIT PACKAGE: 50



18815

(6502381)
Black Nylon

Radiator Grille
Sight Shield Retainer
Dodge Caravan
& Plymouth Voyager
1993-On

UNIT PACKAGE: 50



15050

Black Nylon

Shroud Retainer
High Retention Capability
GM, Ford & Chrysler

UNIT PACKAGE: 50



14709

(Mazda: G030-68-885-B-38;
Ford: F22Z-16774-A,
GA2A-56694)
Nylon

Hood Insulation Retainer
Mazda & Ford Probe

UNIT PACKAGE: 25



19312

(90467-05096-22)
Black Nylon

Luggage Compartment
Trim Panel Retainer
Toyota Tercel & Paseo
1994 - On

UNIT PACKAGE: 25



19506

(90666-SA7-003ZW)
Black Nylon

Trunk Lining Retainer
Acura 2.5TL, 3.2TL, 3.5,
Integra & Legend,
Honda Accord Wagon
& Prelude
1987 - On

UNIT PACKAGE: 15



15367

(20514862)
Black Nylon

Screen Shroud Vent
Grille to Panel Retainer
GM 1985-On

UNIT PACKAGE: 50



21661

(TD11-56-694)
Black Nylon

Hood Insulation Retainer
Mazda 3, 5, 6, CX7, CX9,
MX5 Miata & RX8
2004 - On

UNIT PACKAGE: 25



21303

(90671-S0D-003ZK)
Black Nylon

Trunk Lid & Interior Trim
Retainer
Honda Accord 2010-On

UNIT PACKAGE: 25



21349

(85746-06000LX)
Gray Nylon

Headliner Retainer
Kia Rio 2010 - On

UNIT PACKAGE: 25



11675

(GM: 25514221;
Chry: 6003587)
Black Nylon

Roof Headliner Retainer
GM & Chrysler
1982-On

UNIT PACKAGE: 50



20399

(W701374-S)
Black Nylon

Hood Insulation Retainer
Ford Escape
2001-On

UNIT PACKAGE: 25



21589

(99045AE03AMA)
Black Nylon

Trim Panel Retainer
Subaru B9 Tribeca,
Impreza, Legacy &
Outback 2005 - On

UNIT PACKAGE: 25



21350

(85746-06000RU)
Tan Nylon

Headliner Retainer
Kia Rio 2010 - On

UNIT PACKAGE: 25



21199

(Ford: W711687-S300;
GM: 11589181)
Black Nylon

Bumper and Fender
Apron Retainer
Ford Focus and
GM Full-Size Pick-Up
Trucks
2007 - On

UNIT PACKAGE: 25



11679

(GM: 20032850;
Ford: 387258-S;
Chry: 3861577)
Black Nylon

Mud Shield Retainer
GM, Ford & Chrysler
1976-On

UNIT PACKAGE: 100

Sec. 19**TRIMMING SUNDRIES & FASTENERS**

Refer to Retainer Specification Chart on pages 404 - 413

**13454**
(20511451)
Black NylonCowl Vent Retainer
GM 1984-On

UNIT PACKAGE: 25

**13198**
(4-29-29-06)
Black NylonInterior Trim Retainer
Fiat

UNIT PACKAGE: 50

**21332**
(90467-05164-E2)
Tan NylonHeadliner Retainer
Toyota Corolla & Yaris
2009 - On

UNIT PACKAGE: 25

**14757**
(N804448)
Black NylonEngine Mount
Heat Shield Retainer
Ford Taurus & Sable
1986-On

UNIT PACKAGE: 25

**11347**
(3861577)
Black NylonFront Seat Adjuster Cover
Retainer
Chrysler 1975-On

UNIT PACKAGE: 25

**18820**
(N807951S)
Black NylonAccess Hole
Cover Retainer
Ford Mustang
1994-On

UNIT PACKAGE: 100

**21560**
(G032-68-865A-00)
Black NylonTrunk & Carpet Retainer
Mazda B2000, B2600,
CX-7, CX-9, Miata,
Millenia, MX-3, MX-5, MX-6,
Protege, RX-7,
RX-8, 3, 5, 6, 626 & 929
1987 - On

UNIT PACKAGE: 25

**19470**
(90108-SW3-003)
Black Nylon**Use With Auveco 19650**
Honda Accord,
Odyssey & Prelude
1995-On

UNIT PACKAGE: 15

**19643**
(90467-06175)
Black NylonLuggage Compartment
Retainer
Toyota Solara
1998 - On

UNIT PACKAGE: 15

**19667**
(N801994-S100)
Black NylonTrim Panel Retainer
Ford
1982 - On

UNIT PACKAGE: 25

**21673**
(W715926-S300)
Black NylonFender, Bumper, Trunk
& Interior Trim Retainer
Ford Escape & Focus
2012 - On

UNIT PACKAGE: 25

**19744**
(90669-SP0-003ZA)
Black NylonTrunk Trim Retainer
Honda Civic
1998 - On

UNIT PACKAGE: 10

**20184**
(90467-08186)
Black NylonLuggage Compartment
Trim Retainer
Toyota Camry
1999 - On

UNIT PACKAGE: 25

**21253**
(90467-05164-B6)
Gray NylonHeadliner Retainer
Toyota Yaris 2009 - On

UNIT PACKAGE: 25

**21630**
(95022-AC040ML)
Black NylonHeadliner & Trim
Space Retainer
Subaru Forester, Impreza,
Legacy & Outback
1998 - On

UNIT PACKAGE: 25

**19893**
(6501948)
Black NylonFender & Bumper
Shield Retainer
Chrysler
1995 - 89

UNIT PACKAGE: 50

Refer to Retainer Specification Chart on pages 404 - 413



20334
(90667-SOD-003ZC)
Black Nylon
Trunk Garnish Retainer
Honda Civic
1998 - On

UNIT PACKAGE: 15



18174
(25601491)
Black Nylon
Radiator Air Side
Baffle & Door Trim
Panel Retainer
Buick LeSabre &
Olds Delta 88 Royale
1992-On

UNIT PACKAGE: 50



15040
(Chrys: 5208743;
AMC: 4006529)
Black Nylon
Trim Panel Retainer
Chrysler 1988-84
AMC 1988-84

UNIT PACKAGE: 50



16776
(Honda: 90667-SAO-0030;
Nissan: 76996-01P02)
Black Nylon

Trim Panel Retainer
Honda & Nissan

UNIT PACKAGE: 25



20531
(W708035-S300)
Black Nylon
Rear Bumper Cover
Retainer
Use With Auveco 20532
Ford Expedition
2003 - On

UNIT PACKAGE: 25



19774
Black Nylon
Bumper Cover
Retainer
Postal Vehicles
& General Purpose
**Replaces Auveco
18106**

UNIT PACKAGE: 25



19842
(75867-30110)
Black Nylon
Rocker Panel Clip
Toyota Corolla
1997 - On

UNIT PACKAGE: 15



16818
(GM: 21094146,
21110201;
Chrys: 6501301)
Black Nylon
Trim Panel Retainer
GM Saturn 1991-On
Sliding Door & Lift Gate
Trim Panel Retainer
Chrys. Mini Vans 1987-On

UNIT PACKAGE: 25



20624
(Ford: W709002-SAA)
Black Nylon
Fender Flare Retainer
Ford Expedition & Navigator
2003 - On

UNIT PACKAGE: 25



18379
(W701380SSW)
Black Nylon
Retainer
Trunk Liner, Rear Seat
Carpet, & Radiator
Side Shield
Ford Contour & Mercury Mystique
1995-On

UNIT PACKAGE: 25

Sec. 19

TRIMMING SUNDRIES & FASTENERS

Refer to Retainer Specification Chart on pages 404 - 413



18301

(GM: 10185925;
Chrys: 6503768)
Black Nylon

Bumper Fascia Retainer
Chevy Lumina APV,
Olds Silhouette
& Pontiac Trans Sport
1993-On

UNIT PACKAGE: 25



20366

(W701855-S300)
Black Nylon

Fender Liner &
Mud Flap Retainer
Ford Explorer &
Mountaineer
2002 - On

UNIT PACKAGE: 25



20192

(Not Available
From O.E.M.)
Black Nylon

Mud Flap Retainer
Ford Expedition & F-150
1997 - On

UNIT PACKAGE: 25



19352

(N807155-S)
Medium Mist Gray

UNIT PACKAGE: 25



20177

(W705955-S300)
Charcoal Gray
Nylon

Wheel Opening
Moulding Retainer
Ford Explorer
1998 - On

UNIT PACKAGE: 50

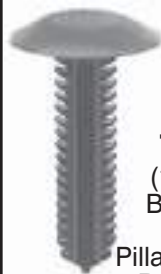

14032

(15588078)
Black Nylon

Pillar Cover
Retainer
GM Truck
1985-On

UNIT PACKAGE: 10



20926

(W710532-S300)
Black Nylon

Rocker Moulding Retainer
Ford Mustang
2005 - On

UNIT PACKAGE: 25



19855

(4717224)
Black Nylon

Trim Panel Retainer
Chrysler Concorde,
Intrepid, LHS,
New Yorker, Vans & Vision
1993 - On

UNIT PACKAGE: 50



18859

(10119816)
Black Nylon

Panel Retainer
Air Intake Grille
Panel Retainer
Chevrolet Camaro
1991-On

UNIT PACKAGE: 25



14036

(14074081)
Black Nylon

Rear Hood
Seal Retainer
GM 1983-On

UNIT PACKAGE: 25



14035

(22527720)
Natural Nylon

Hood Seal
Retainer
GM 1981-On

UNIT PACKAGE: 25



20761

(W710312-S300)
Black Nylon

Cowl Vent Retainer
Ford Trucks
2004 - On

UNIT PACKAGE: 25



18371

(15986343)
Gray Nylon

Door Trim
Panel Retainer
Chev. Astro
& GMC Safari
Mini Vans
1994-On

UNIT PACKAGE: 25

When The World
Thinks Of
Body Hardware
&
Specialty
Fasteners,
Only One Name
Comes To
Mind.....
Auveco

TRIMMING SUNDRIES & FASTENERS

Sec. 19

Refer to Retainer Specification Chart on pages 404 - 413



10831
 (GM: 332364, 14093311,
 20732399;
 Ford: 389358,
 W701259-S300;
 Chry: 3691590,
 6031321, 6505411-AA,
 AMC: 4004569)
 Black Nylon
 Fender & Bumper
 Shield Retainer
 GM, Ford, Chrysler & AMC
 UNIT PACKAGE: 50

16259
 Same as 10831
 except for packing
 UNIT PACKAGE: 100



10832
 (GM: 480534, 6270163;
 Chrys: 6030538)
 Gray Nylon
 Fender & Bumper Shield
 Retainer
 GM 1973-On
 Chrysler
 UNIT PACKAGE: 50



15664
 White Nylon
 Fender & Bumper Shield
 Retainer
**White Version Of
 Auveco 10831**
 GM, Ford, Chrysler & AMC
 UNIT PACKAGE: 100



11146
 (GM: 11569768,
 15958694,
 1605396;
 Chry: 6030441;
 Ford: 388577S,
 W705589-S300)
 Black Nylon
 Radiator Yoke, Fender &
 Bumper Shield Retainer
 GM, Ford & Chrysler
 UNIT PACKAGE: 25

15414
 Same as 11146
 except for packing
 UNIT PACKAGE: 100



19790
 (Not Available
 From O.E.M.)
 Gray Nylon
 Trim Panel Retainer
**Gray version of
 Auveco 11146**
 GM, Ford & Chrysler
 UNIT PACKAGE: 50



19250
 (Not Supplied
 By O.E.M.)
 White Nylon
 Trim Panel Retainer
**White Version Of
 Auveco 11146**
 UNIT PACKAGE: 25



17664
 (GM: 10121502;
 Chry: 6033082,
 6033840;
 Ford: 390018-S)
 Black Nylon
 Shield Retainer
 Battery Post Cable Shield,
 Engine Splash Shield
 Radiator Side Air Baffle
 GM 1989-On
 UNIT PACKAGE: 50



17612
 (Chry: 6504043;
 Ford: N807721-S)
 Black Nylon
 Trim Panel Retainer
 Ford Explorer
 1993-On
 Trunk Lid Latch
 Chrysler 1996-On
 UNIT PACKAGE: 50



Trim Panel
 Retainer
 Ford Explorer, Mountaineer,
 Windstar & Ranger
 1991-On
19371
 (N807154-S)
 Dark Denim (Blue) Nylon
 UNIT PACKAGE: 50

19372
 (N807154-S)
 Dark Graphite (Gray) Nylon
 UNIT PACKAGE: 50

19373
 (N807154-S)
 Zuca Granite
 (Light Gray) Nylon
 UNIT PACKAGE: 50

19374
 (N807154-S)
 Medium Prairie Tan Nylon
 UNIT PACKAGE: 50



20878
 (90467-A0008)
 Black Nylon
 Bumper Cover Retainer
 Toyota, Lexus & Scion
 1995 - On
 UNIT PACKAGE: 50



16775
 (Honda: 90667-SA7-0030;
 Nissan: 89427-98070)
 Black Nylon
 Trim Panel Retainer
 Honda & Nissan
 UNIT PACKAGE: 25



19121
 (90467-08104)
 Gray Nylon
 Roof Headliner Retainer
 Toyota MR2
 1990-On
 UNIT PACKAGE: 15



21026
 (4860379-AA)
 Black Nylon
 Door Trim Panel Retainer
 Dodge 300 Series,
 Magnum & Charger
 2005 - On
 UNIT PACKAGE: 25

Sec. 19

TRIMMING SUNDRIES & FASTENERS

Refer to Retainer Specification Chart on pages 404 - 413



16132

Black Nylon

Trim Panel Retainer
Universal

UNIT PACKAGE: 25



15543

(GM: 22547243,
11610086,
Chry: 6501916)
Black Nylon

Splash Shield & Wheel Well
Cover Retainer
Chrysler 1988-On
Hood Seal Retainer
GM 1989-On

UNIT PACKAGE: 50



20167

(01553-02041)
Black Nylon

Splash Shield Retainer
Nissan Frontier
1997 - On

UNIT PACKAGE: 25



21392

(1H0-819-055-B01C)
Black Nylon

Instrumental Panel, Cowlf
Vent, Defroster Grille &
Ducts Retainer
Phillips Drive,
Audi and Volkswagen
Cabrio, Golf & Jetta
2002-1993

UNIT PACKAGE: 25



21257

(Chrys:
6508727-AA;
Ford:
W706815-S300)
Black Nylon

Trunk Trim and Insulator
Retainer
Ford Focus, Fusion, Milan,
MKZ & Zephyr
2006 - On

UNIT PACKAGE: 25



17076

(GM: 94145515;
Isuzu:
8941455150)
Black Nylon

Inner Fender Shield &
Bumper Fascia Retainer
Geo Storm & Isuzu
1990-On

UNIT PACKAGE: 25

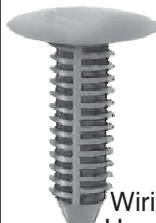

19834

(15975244)
Black Nylon

Wiring Harness &
Headliner Retainer
Engine Wiring Harness,
Tailgate, Headliner &
Air Cleaner
GM C, E, K, S & T Trucks
1994 - On

UNIT PACKAGE: 50



19837

(Not Available
From O.E.M.)
Black Nylon

Trim Panel Retainer
Chrysler

UNIT PACKAGE: 50



19127

(N808370-S)
Black Nylon

Carpet Retainer
Ford Taurus & Sable
1996-On

UNIT PACKAGE: 25



18685

(3548804)
Black Nylon

License Plate Bracket &
Bumper Fascia Retainer
Cadillac Eldorado & Seville
1995-On

UNIT PACKAGE: 25



20189

(GM: 16674629;
Ford: N806113-S;
Chry: 6503943)
Black Nylon

Trim Panel Retainer
Cadillac Concours,
DeVille & Seville;
Chevrolet Impala,
Lumina & Monte Carlo;
Dodge Ram & Dakota;
Ford and
Pontiac Grand Prix
1995 - On

UNIT PACKAGE: 50



20319

(W700671-S300)
Black Nylon

Hood Insulation Retainer
Ford Contour & Mystique
1995 - On

UNIT PACKAGE: 25



20360

(GM: 22189414;
Chrys: 6505667-AA)
Black Nylon

Engine Compartment &
Front End Retainer
Buick LeSabre, Park Ave.,
Rendezvous, & Riviera;
Cadillac DeVille & Seville;
Chevrolet Venture,
Oldsmobile Silhouette
And Pontiac Aztek,
Bonneville & Montana
2000 - On
Chrysler 2010 - On

UNIT PACKAGE: 25



21248

(15944588)
Tan Nylon

Headliner Retainer
Chevrolet Malibu 2004 - On

UNIT PACKAGE: 25



19760

(N807535-S)
Black Nylon

Kick Plate Retainer
Ford Ranger
1993 - On

UNIT PACKAGE: 50



21301

(11610747)
Black Nylon

Grille Retainer
Use With Auveco 21302
Cadillac SRS & SRX and
Chevrolet Camaro
2010 - On

UNIT PACKAGE: 25

Refer to Retainer Specification Chart on pages 404 - 413



21338
(15802005)
Black Nylon

Fender & Headliner
Retainer
GM Acadia, Camaro,
Enclave, Traverse,
& Saturn Outlook
2008 - On

UNIT PACKAGE: 25



21090
(24501057)
Black Nylon

Fender Apron &
Radiator Baffle Retainer
Cadillac Escalade,
Chevrolet Denali & Tahoe,
GMC Yukon and
Hummer H3
2006 - On

UNIT PACKAGE: 25



20281
(11518201)
Black Nylon

Bumper Fascia Retainer
Pontiac Grand Am
1999 - On

UNIT PACKAGE: 15



15523
(E9SB-6302354-ACW)
Black Nylon

Cowl Side Trim Retainer
Ford T-Bird & Cougar
1989-On

UNIT PACKAGE: 25



15481
(6501067)
Black Nylon

Fascia Retainer
Chrysler 1985-On

UNIT PACKAGE: 50



11673
(GM: 2048248;
Chry: 6003423)
Natural Nylon

Interior Trim
Panel Retainer
GM & Chrysler 1977-On

UNIT PACKAGE: 50



19541
(6504135)
Black Nylon

Hood Insulation Retainer
Chrysler Mini-Vans & Durango
1997 - On

UNIT PACKAGE: 50



15480
(Ford: N802734S; GM: 22718305)
Black Nylon

Trim Panel & Hood
Insulation Retainer
Ford 1983-On
GM 1997 - On

UNIT PACKAGE: 50



11351
(Ford: 385661-S;
Chry: 6003349, 6032363;
VW: N989022)
Black Nylon

Door Trim Panel Retainer
Ford, Chrysler & VW
1975-On

UNIT PACKAGE: 25



10332
(2998430)
Black Nylon

Radiator Grille Retainer
Chrysler

UNIT PACKAGE: 25

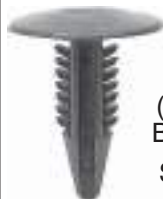

12731
(20319841)
Black Nylon

Seat Back
Retainer
GM Camaro
& Firebird
1982-On

UNIT PACKAGE: 25



12571
(389443-S)
Black Nylon

Fascia To Bumper Retainer
Ford 1981-On

UNIT PACKAGE: 25

Refer to Retainer Specification Chart on pages 404 - 413



20316

(Ford: 388904-S;
Chry: 4381395,
6501086)
Black Nylon

Door Frame Spacer
Retainer
Chrysler 1985-On
Bumper Retainer
Ford 1981-On

Replaces Auveco 14042

UNIT PACKAGE: 50



12137

(1619321)
Black Nylon

Radiator Apron
Panel Retainer
GM 1977-On

UNIT PACKAGE: 25

16263

Same as 12137
except for packing

UNIT PACKAGE: 50



18680

(10229437,
10242316)
Black Nylon

Headliner Trim Finish
Panel Retainer

Buick Skylark, Chevrolet Camaro,
Cavalier, Lumina & Monte Carlo,
Oldsmobile Cutlass And Pontiac
Firebird, Grand Am,
Grand Prix & Sunfire
1992-On

UNIT PACKAGE: 25



20262

(22642756)
Black Nylon

Trunk Trim Retainer
Chevrolet Cavalier &
Pontiac Sunfire
1995 - On

UNIT PACKAGE: 25



18679

(20652520)
Gray Nylon

Compensator Panel To
Quarter Panel Retainer
Buick Century & Skylark, Cadillac
Fleetwood And Olds Calais
1992-83

UNIT PACKAGE: 25



19501

(10249241)
Tan Nylon

Headliner Trim
Panel Retainer

Buick Century, Regal & Skylark;
Chev. Camaro, Cavalier,
Lumina, Monte Carlo & Venture;
Oldsmobile Silhouette and
Pontiac Firebird, Grand Am,
Sunfire & Trans Sport
1995 - On

UNIT PACKAGE: 25



20362

(15056810)
Black Nylon

Bumper Fascia Retainer
GM S & T Trucks
2002 - On

UNIT PACKAGE: 25



15478

(GM: 1631564;
Ford: N804379S,
W706358-S300)
Black Nylon

Bumper Fascia Retainer
Buick, Cadillac & Olds 1981-On
Taurus & Sable 1986-On

UNIT PACKAGE: 50



12766

(22512276)
Black Nylon

Front End Stone Shield
Retainer
GM 1981-On

UNIT PACKAGE: 25

16262

Same as 12766
except for packing

UNIT PACKAGE: 50



18771

(6502104)
Black Nylon

Headlight Mounting Panel To Cross
Member Sight Shield Retainer
Dodge Daytona 1993

UNIT PACKAGE: 25



18688

(10220168,
10241518)
Gray Nylon

Headliner Trim Finish
Panel Retainer

Buick Century & Regal,
Chevrolet Caprice, Camaro,
Lumina & Monte Carlo,
Olds Cutlass Ciera And
Pontiac Firebird &
Grand Prix
1992-On

UNIT PACKAGE: 50

TRIMMING SUNDRIES & FASTENERS

Sec. 19

Refer to Retainer Specification Chart on pages 404 - 413



20345
(15006827)
Gray Nylon

Headliner Retainer
GM C & K Trucks
2000 - On

UNIT PACKAGE: 25



20874
(90467-07049-CO)
Black Nylon

Trim Panel Retainer
Lexus
2000 - On

UNIT PACKAGE: 25



Roof Trim Panel &
Garnish Moulding
Retainers
Ford Ranger
1992-On

18275
(N806344-S)
Blue Nylon

UNIT PACKAGE: 25



20625
(Ford: XW7Z-6302354-AAB)
Tan Nylon

Headliner Retainer
Ford Expedition & Navigator
2003 - On

UNIT PACKAGE: 25



15479
(N804349S)
Black Nylon

Interior Trim
Retainer
Ford 1986-On

UNIT PACKAGE: 25



18277
(N806344-S)
Gray

UNIT PACKAGE: 25



12759
(14027471)
Black Nylon

Trim Panel
Retainer
GM Trucks
1981-On

UNIT PACKAGE: 25



21241
(W706635-SSW)
Black Nylon

Rocker, Pillar &
Fender Liner Retainer
Ford Fusion & Taurus
2009 - On

UNIT PACKAGE: 50



21228
(10444839)
Tan Nylon

Headliner Retainer
Chevrolet Express Van &
GMC Savana Van
2004 - On

UNIT PACKAGE: 25



12909
(388930-S)
Black Nylon

Trim Panel Retainer
Ford 1980-On

UNIT PACKAGE: 50

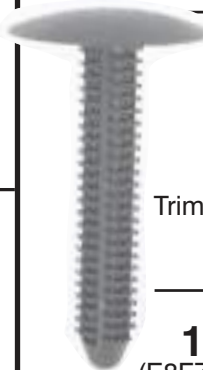

19845
(E8FZ-5802354A)
Medium Graphite Nylon

UNIT PACKAGE: 25

19846
(F2UZ-1602354AAA)
Black Nylon

UNIT PACKAGE: 25



21287
(25822063)
Opal Gray Nylon

Headliner Retainer
Chevrolet Silverado
Hybrid
2010 - On

UNIT PACKAGE: 25

Sec. 19**TRIMMING SUNDRIES & FASTENERS****Refer to Retainer Specification Chart on pages 404 - 413****21288**
(65846-4Z000)
Black NylonHood Insulation Retainer
Nissan Altima
2010 - On

UNIT PACKAGE: 15

**21443**
(11571159)
Black NylonHood Insulation Retainer
Chevrolet Cruze
2011 - On

UNIT PACAKGE: 25

**17381**
(N805315)
Gray NylonHeadliner Retainer
Ford Aerostar
1986-On

UNIT PACKAGE: 10

**19468**
(65846-40F00)
Black NylonHood Insulation Retainer
Infiniti J30, M30 & Q45
1989 - On

UNIT PACKAGE: 15

**21313**
(W708633-S300)
Black NylonHood Insulation Retainer
Ford Fusion
2010 - On

UNIT PACKAGE: 25

**14219**
(20432601)
Black NylonSpeaker Cover To
Bracket Retainer
GM
1985-On

UNIT PACKAGE: 25

**21380**
(15989431)
Black NylonHood Insulation Retainer
Chevrolet Traverse
2010 - On

UNIT PACKAGE: 25

**11842**
(N-800387-S)
Black NylonDashboard Retainer
Ford
1979-On

UNIT PACKAGE: 25

**19338**
(Chry: 6504098;
Ford: N808842-S)
Black NylonHood Insulation Retainer
Chrysler Sebring 1996-On
Ford Taurus, Sable
& Mark VIII
1996-On

UNIT PACKAGE: 50

**15998**
(90700-SB2-003)
Black NylonHood Insulation Retainer
Honda Prelude
1985 - On

UNIT PACKAGE: 15

**11350**
(4005250)
White NylonDoor Panel Retainer
American Motors
1976-On

UNIT PACKAGE: 25

**20615**
(11517992)
Black NylonFender Liner Retainer
Pontiac Bonneville
2000 - On

UNIT PACKAGE: 25

**21421**
(90913-0074)
Black NylonHood Insulation Retainer
Subaru Baja, Forester, Impreza,
Legacy, Outback & Tribeca
1998 - On

UNIT PACKAGE: 15

TRIMMING SUNDRIES & FASTENERS

Sec. 19

Refer to Retainer Specification Chart on pages 404 - 413



20541
(TY98TL2-AA)
Tan Nylon

Headliner Retainer
Chrysler Caravan, Town & Country
And Voyager Mini-Vans
2001 - On

UNIT PACKAGE: 25



15456
(20064875)
Black Nylon

Hood Insulation Retainer
GM 1980-On

UNIT PACKAGE: 25



15668
(N803387)
Black Nylon

Trim Panel Retainer
Ford

UNIT PACKAGE: 25



15457
(20030401)
Black
Polypropylene

Hood Insulation Retainer
GM 1980-On

UNIT PACKAGE: 25



11130
(3078511,
3977775)
Black Nylon

Hood Insulation Retainer
GM 1964-On

UNIT PACKAGE: 25



17215
(21039141)
Black Nylon

Hood Insulation Retainer
GM Saturn
1991-On

UNIT PACKAGE: 25



21385
(89026634)
Light Gray Nylon

Headliner Retainer
Chevrolet Impala
2010 - On

UNIT PACKAGE: 25



21227
(25749564)
Tan Nylon

Headliner Retainer
Chevrolet Express Van
& GMC Savana Van
2004 - On

UNIT PACKAGE: 15



21386
(89026635)
Tan Nylon

Headliner Retainer
Chevrolet Impala
2010 - On

UNIT PACKAGE: 25



16863
(N803613S)
Black Nylon

Hood Insulation Retainer
Ford Bronco, Explorer & Ranger
1988-On

UNIT PACKAGE: 25

**Please Order
In Unit Package
Quantities
Not Number Of
Pieces**



18827
(6503892)
Black Nylon

Hood Insulation Retainer
Chrysler Cirrus & Stratus
1995 - On

UNIT PACKAGE: 50

Refer to Retainer Specification Chart on pages 404 - 413



19655
(386553-S)
Black Nylon
Hood Insulation Retainer
Ford 1975-On
Replaces Auveco 13571
UNIT PACKAGE: 25



21211
(53326-08010)
Black Nylon
Hood Insulation Retaining Clip
Toyota Sienna
2009 - On
UNIT PACKAGE: 25



19155
(4428987)
Black Nylon
Hood Insulation Retainer
Dodge Ram
1994- On
UNIT PACKAGE: 25



14163
(388908-S)
Black Nylon
Hood Insulation Retainer
Ford
1975- On
UNIT PACKAGE: 50



20164
(4878883AA)
Black Nylon
Hood Insulation Retainer
Chrysler LH & LHS Series
1997 - On
UNIT PACKAGE: 50



17237
(Nissan: 65832-F5000,
65846-30F00)
Black Nylon
Hood Insulation Retainer
Mercury Villager
1999- On
Nissan
1981 - On
UNIT PACKAGE: 15



21652
(91501-SWA-003)
Black Nylon
Hood Insulation Retainer
Honda Civic
2012 - On
UNIT PACKAGE: 25



18746
(90700-SJ4-000)
Black Nylon
Hood Insulation Retainer
Head Diameter: 30mm
Stem Diameter: 15mm x 18mm
Stem Length: 6mm
Acura Legend 1991 - On
Honda 1998 - On
UNIT PACKAGE: 15



17975
(Chry: 6502842,
GM: 21039129)
Black Nylon
Hood Insulation Retainer
Chrysler Concorde, Dodge Intrepid
& Eagle Vision
1993 - On
GM Corvette, Equinox & Saturn
1992 - On
UNIT PACKAGE: 50



17004
(4341060)
Black Nylon
Hood Insulation & Fender
Shield Retainer
Chrysler 1985- On
UNIT PACKAGE: 25



20609
(91501-S1K-003,
91501-STK-003)
Black Nylon
Hood Insulation Retainer
Acura 3.5RL & RSX and
Honda Civic & CR-V
2000 - On
UNIT PACKAGE: 25

TRIMMING SUNDRIES & FASTENERS

Sec. 19

Refer to Retainer Specification Chart on pages 404 - 413



13467
(GM: 7642589;
AMC: 4001934)
Black Nylon
Firewall Insulation
Retainer
GM & AMC
UNIT PACKAGE: 25



14985
(2664040)
White Nylon
Door Weatherstrip Retainer
Chrysler
1966 - On
UNIT PACKAGE: 100



14328
(90664-671-0030)
White Nylon
Weatherstrip Retainer
Honda
UNIT PACKAGE: 50



13757
(389809)
Black Nylon
Hood Insulation Retainer
2" Square
GM 1980 - On
UNIT PACKAGE: 25



14299
(73862-672-0030)
White Nylon
Weatherstrip Retainer
Honda
UNIT PACKAGE: 50



20180
(Not Available From O.E.M.)
Black Nylon
Weatherstrip Retainer
Chrysler LH & LHS Series
1997 - On
UNIT PACKAGE: 100



20182
(Not Available From O.E.M.)
White Nylon
Weatherstrip Retainer
Chrysler LH & LHS Series
1997 - On
UNIT PACKAGE: 100



10744
(4876498)
Black Nylon
Weatherstrip Retainer
GM
UNIT PACKAGE: 100



17072
(15659161)
Black Nylon
Front Door Frame Hole Plug
GM Blazer, Jimmy & Pickup
1989-On
UNIT PACKAGE: 25



18510
(20200750)
Natural Nylon
Hood Seal Retainer
Buick, Cadillac, Chevrolet,
GMC & Oldsmobile
1970 - On
UNIT PACKAGE: 100



19678
(Not Available From O.E.M.)
White Nylon
Weatherstrip Retainer
Ford Windstar
1995 - On
UNIT PACKAGE: 50



19532
(W702010-S300)
Black Nylon
Door Weatherstrip Retainer
Ford Contour & Mystique
1995 - On
UNIT PACKAGE: 25



21382
(86434-4A000)
Black Nylon
Hood Seal Retainer
Hyundai Elantra, Sonata & Tucson
and Kia Sportage
2009 - On
UNIT PACKAGE: 50



18509
(4040732)
Black Nylon
Weatherstrip Retainer
Hood Inner Panel To Cowl &
Door Weatherstrip
Dodge F.W.D. Pick-Up
1989-82
UNIT PACKAGE: 100

Sec. 19**TRIMMING SUNDRIES & FASTENERS**

Refer to Retainer Specification Chart on pages 404 - 413

**21381**(86438-4A100)
Black NylonHood Seal Retainer
Hyundai Elantra &
Tucson and Kia
Forte & Sportage
2009 - On

UNIT PACKAGE: 50

**19418**(GM: 480534;
Ford: 384051-S)
Black NylonCowl Insulation Retainer
GM
Splash Shield and Wire Retainer
Ford

UNIT PACKAGE: 25

**20760**(Not Available From O.E.M.)
Natural NylonWeatherstrip Retainer
Chrysler 300 & Dodge Magnum
2005 - On

UNIT PACKAGE: 100

**19425**(385677)
Natural NylonWeatherstrip Retainer
Ford

UNIT PACKAGE: 50

**21125**(Not Available
From O.E.M.)
Black NylonFront Bumper Retainer
Cadillac STS
2005 - On

UNIT PACKAGE: 15

**19850**(N806340-S)
Natural NylonWeatherstrip Retainer
Ford F150
1999 - On

UNIT PACKAGE: 100

**8853**(C5AB-6220586A)
Natural NylonDoor Weatherstrip Retainer
Ford

UNIT PACKAGE: 50

**21565**(90331-AA050)
White NylonWeatherstrip Retaining Clip
Subaru Forester
2008 - 03

UNIT PACKAGE: 25

**19325**(MU481027)
Brown NylonHood Weatherstrip
Retainer
Mitsubishi Eclipse & Diamante
1991 - On

UNIT PACKAGE: 25

**21334**(W711858-S300)
White NylonWeatherstrip Retainer
Ford Edge & MKX
2007 - On

UNIT PACKAGE: 100

**21143**(51-71-1-496-621)
Black NylonRocker Moulding Retainer
Mini-Cooper
2002 - On

UNIT PACKAGE: 25

**21552**(90467-04034)
White NylonWeatherstrip Retainer
Lexus CT 200h, HS 250h, IS F,
IS 250, IS 350, LS 460, LS 600h,
RX 350, RX 400h & RX 450h and
Toyota Avalon, Corolla, Highlander,
Matrix, Prius, RAV-4, Scion & Venza
2003 - On

UNIT PACKAGE: 25

**19481**(GA2A-58-762)
Blue NylonFront & Rear Door
and Hood Weatherstrip
Mazda 626 & Millennia
1995 - On

UNIT PACKAGE: 50

**19449**(10403591)
Black NylonRear Bumper Fascia Retainer
Oldsmobile Intrigue &
Pontiac Grand Prix
1998 - On

UNIT PACKAGE: 25

TRIMMING SUNDRIES & FASTENERS

Sec. 19

Refer to Retainer Specification Chart on pages 404 - 413



20181
(Not Available From O.E.M.)
White Nylon

Weatherstrip Retainer
Chrysler LH & LHS Series
1997 - On

UNIT PACKAGE: 100



19368
(10283414, 10405030)
Natural Nylon

Door Weatherstrip Retainer
Buick Century & Regal and
Oldsmobile Intrigue
1997 - On

UNIT PACKAGE: 100



21229
(65810-K2000)
Black Nylon

Hood Seal
Retaining Clip
Infiniti 130, 135, Q45 & QX4
and Nissan Maxima & Pathfinder
2004 - 1996

UNIT PACKAGE: 25



20831
(Not Available From O.E.M.)
Blue Nylon

Weatherstrip Retainer
Ford Explorer
2005 - On

UNIT PACKAGE: 100

Remember...
All Items In
This Catalog
Are Available In
Bulk Quantities.
Call For A Quote



18692
(Ford: E7GZ-6120586-B;
Mazda: G031-58-762;
Toyota: 67868-89101,
67867-28030,
67867-89103)
Natural Nylon

Weatherstrip Retainer
Toyota 4-Runner
1989-83

Mazda 1996 - On
Ford 1996 - On

UNIT PACKAGE: 50



19171
(91568-SR2-003)
Green Nylon

Weatherstrip Retainer
Honda Odyssey
1995 - On

UNIT PACKAGE: 100



19749
(67867-12150)
White Nylon

Weatherstrip Retainer
Toyota Avalon
1995 - On

UNIT PACKAGE: 15



20443
(67867-0C010)
Black Nylon

Weatherstrip Retainer
Toyota Tundra
1999 - On

UNIT PACKAGE: 25



18877
(91530-SP1-003)
Orange Nylon

Weatherstrip Retainer
Acura 3.5 RL & Honda
Accord, Civic, & Odyssey
1992 - On

UNIT PACKAGE: 25



19116
(91530-ST5-003)
Natural Nylon

Weatherstrip Retainer
Honda Civic
1995 - On

UNIT PACKAGE: 10



17339
(N806289-S)
Black Nylon

Weatherstrip Retainer
Lincoln 1989 - On

UNIT PACKAGE: 50



19684
(01553-09311)
Blue Nylon

Weatherstrip Retainer
Nissan Altima & Sentra
1994 - On

UNIT PACKAGE: 25



18033
(Chrys: 4696129;
GM: 21077575)
White Nylon

Weatherstrip Retainer
Chrysler Concorde & LHS
Dodge Intrepid & Eagle Vision
1993 - On

Oldsmobile Alero &
Pontiac Grand Am
1999 - On

UNIT PACKAGE: 50



21633
(80850-89900)
White Nylon

Weatherstrip Retainer
Infiniti 130, 135 & M45
and Nissan Maxima
2004 - 2000

UNIT PACKAGE: 25



19683
(91502-S84-A11)
Black Nylon

Cowl Vent
Retaining Clip
Honda Odyssey
1999 - On

UNIT PACKAGE: 15

Sec. 19**TRIMMING SUNDRIES & FASTENERS**

Refer to Retainer Specification Chart on pages 404 - 413

**17991**(90467-06092)
Black NylonRetaining Clip
Lexus 1990 - On

UNIT PACKAGE: 10

**19720**

(90467-06138)

Black & White Nylon

Hood To Cowl Seal Retainer
Toyota Avalon & Camry
1994 - On

UNIT PACKAGE: 10

**21295**(01553-08961)
Black NylonWeatherstrip
Retaining Clip
Nissan Altima
2009 - On

UNIT PACKAGE: 25

**18330**(94848189,
94848192)
White NylonFront Door Weatherstrip Retainer
Geo Prizm
1992 - 89

UNIT PACKAGE: 25

**18508**(4001916)
Black NylonWeatherstrip Retainer
Jeep Wrangler
1991 - On

UNIT PACKAGE: 50

**3639**(C1AB-6220807-A)
White NylonDoor Flange
Weatherstrip Retainer
Ford

UNIT PACKAGE: 100

**19728**(90467-10146)
Black NylonCowl Panel Retainer
Toyota Sienna Van
1997 - On

UNIT PACKAGE: 25

**11136**(Ford: 385330-S,
D30Z-16776-A;
Chry: 6003351)
Black NylonHood Insulation Retainer
Chrysler 1972 - On
Grille to Radiator Retainer
Ford 1973 - On

UNIT PACKAGE: 25

**3620**(4801268)
Black NylonDoor Flange
Weatherstrip Retainer
GM

UNIT PACKAGE: 100

**19724**(65810-K2009)
White NylonHood To Cowl Seal Retainer
Infiniti & Nissan Pathfinder
1992 - On

UNIT PACKAGE: 25

**18248**(55055098)
Black NylonHeadlight Grille Retaining Clip
Dodge Ram
1994 - On

UNIT PACKAGE: 25

**19483**(91515-SR3-000)
Black NylonRear Hood Cowl
Weatherstrip Retaining Clip
Acura Integra, Honda Civic, CR-V
& Del Sol
1992 - On

UNIT PACKAGE: 25

**18166**(80875-85E00)
Black NylonTrim Panel Retainer
Nissan Maxima 1989 - On

UNIT PACKAGE: 25

**21573**(90331-GA090)
Black NylonWeatherstrip Retaining Clip
Subaru Forester & Legacy
2008 - 1990

UNIT PACKAGE: 25

**18818**(91513-SE0-003)
Natural NylonHood Seal Retainer
Honda Accord & Prelude
1983 - On

UNIT PACKAGE: 25

**14355**(01533-00401)
Black NylonRetaining Clip
Nissan

UNIT PACKAGE: 50

TRIMMING SUNDRIES & FASTENERS

Sec. 19

Refer to Retainer Specification Chart on pages 404 - 413

 <p>14291 (66435-648-0000) Black Nylon</p> <p>Retaining Clip Honda</p> <p>UNIT PACKAGE: 50</p>	 <p>21626 (90467-06128) Black Nylon</p> <p>Weatherstrip Retaining Clip Toyota Camry & RAV-4 1992 - On</p> <p>UNIT PACKAGE: 15</p>	 <p>14282 (90687-SA5-0030) Black Nylon</p> <p>Retaining Clip Honda</p> <p>UNIT PACKAGE: 50</p>
 <p>14349 (Mazda: 9926-40-543A; Nissan: 01553-00291) Black Nylon</p> <p>Retaining Clip Mazda & Nissan</p> <p>UNIT PACKAGE: 50</p>	 <p>21296 (90080-46010) Black Nylon</p> <p>Hood Seal Retaining Clip Toyota Camry 2010 - On</p> <p>UNIT PACKAGE: 50</p>	 <p>17452 (01553-00545) Black Nylon</p> <p>Bumper Fascia Retainer Nissan Sentra 1990 - On</p> <p>UNIT PACKAGE: 25</p>
 <p>19014 (90467-10123) Natural Nylon</p> <p>Trim Panel Retainer Toyota Celica 1993 - On</p> <p>UNIT PACKAGE: 10</p>	 <p>18297 (Toyota: 90467-08004, 90467-08011; GM: 94842841, 94849113) Black Nylon</p> <p>Hood Seal Retaining Clip Lexus, Toyota, Geo Prizm & Nova 1985-On</p> <p>UNIT PACKAGE: 50</p>	 <p>21643 (90467-08101) Black Nylon</p> <p>Hood To Cowl Top Seal Retaining Clip Lexus ES 300 and Toyota Camry, Sequoia, Solara & Tundra 2006 - 1997</p> <p>UNIT PACKAGE: 25</p>
 <p>5592 (375372-S) Black Nylon</p> <p>Radiator Top Shield Retainer Ford</p> <p>UNIT PACKAGE: 100</p>	 <p>20643 (000-997-91-86) Black Nylon</p> <p>Retainer Mercedes-Benz</p> <p>UNIT PACKAGE: 10</p>	 <p>18157 (90672-671-003) Gray Nylon</p> <p>Headliner & Cowl Grille Retaining Clip Honda Accord 1986 - On</p> <p>UNIT PACKAGE: 25</p>
 <p>19467 (91501-SL4-003) Black Nylon</p> <p>Front Cowl Retaining Clip Acura 3.5 RL 1996 - On</p> <p>UNIT PACKAGE: 25</p>	 <p>14352 (76876-W5000) Black Nylon</p> <p>Retaining Clip Nissan</p> <p>UNIT PACKAGE: 50</p>	 <p>14736 (90467-06161-01) Black Nylon</p> <p>Retaining Clip Toyota</p> <p>UNIT PACKAGE: 25</p>
	 <p>14737 (Nissan: 01553-00172; Toyota: 90467-07050, 90467-08008) Black Nylon</p> <p>Retaining Clip Nissan & Toyota</p> <p>UNIT PACKAGE: 25</p>	 <p>19331 (MB869072) Black Nylon</p> <p>Headliner & Trunk Trim Retaining Clip Mitsubishi Diamante 1995-91</p> <p>UNIT PACKAGE: 15</p>

Sec. 19**TRIMMING SUNDRIES & FASTENERS**

Refer to Retainer Specification Chart on pages 404 - 413

**18271**(9926-40-531B)
Black NylonHood Insulation Retainer
Mazda

UNIT PACKAGE: 25

**20381**(Honda: 90667-671-013ZA;
Mitsubishi: MC440901;
Nissan: 62660-48600-1)
Black NylonTrim Panel Retaining Clip
Honda, Mitsubishi & Nissan

UNIT PACKAGE: 25

**19729**(90467-09050,
90467-A0003)
Black NylonHood Insulation Retainer
Lexus, Toyota Camry & Solara
1998 - On

UNIT PACKAGE: 15

**17990**(90467-09138)
Black NylonRetaining Clip
Lexus
1990-On

UNIT PACKAGE: 5

**19123**(90467-10107)
Black NylonFender Apron Seal Clip
Toyota 2WD & 4WD Truck
1988 - On

UNIT PACKAGE: 10

**19113**(90467-08124)
Black NylonHood Insulation Retainer
Toyota Supra 1993 - On
Lexus 1994 - 89

UNIT PACKAGE: 15

**19122**(90467-08122)
Natural NylonHeadliner Retaining Clip
Toyota Tacoma & T100
1992 - On

UNIT PACKAGE: 15

**21634**(90467-10186)
Black NylonDash & Fender Apron
Seal Retainer
Lexus and Toyota
1996 - On

UNIT PACKAGE: 25

**19323**(MU481187)
Black NylonHood Insulation Retainer
Mitsubishi Diamante
1993 - On

UNIT PACKAGE: 15

**16781**(Honda: 90670-692-0030;
Toyota: 90467-09065)
Black NylonRetaining Clip
Honda & Toyota

UNIT PACKAGE: 25

**20882**(91501-SEA-003)
Black NylonCowl & Garnish Retainer
Honda Civic
2006 - On

UNIT PACKAGE: 10

**19385**(MB020923)
Gray NylonHood Insulation Retainer
Jeep Eagle &
Mitsubishi Eclipse
1992 - On

UNIT PACKAGE: 10

**14348**(27948-M7002)
Black NylonRetaining Clip
Nissan

UNIT PACKAGE: 25

**20671**(01553-0052U)
Black NylonTrim Panel Retaining Clip
Nissan Frontier & Xterra
2000 - On

UNIT PACKAGE: 25

**18878**(90467-08081)
Black NylonHood Insulation Retainer
Toyota Celica
1993 - 89

UNIT PACKAGE: 15

TRIMMING SUNDRIES & FASTENERS

Sec. 19

Refer to Retainer Specification Chart on pages 404 - 413



19112
(90467-09004)
Black Nylon
Hood Insulation Retainer
Toyota Tacoma
1995 - On
UNIT PACKAGE: 15



18114
(91520-SM4-C010)
Black Nylon
Hood Insulation Retaining Clip
Honda & Acura
1990 - On
UNIT PACKAGE: 25



18458
(Ford: F1CZ-16774-A;
Mazda: B455-56-741)
Black Nylon
Hood Insulation Retaining Clip
Ford Probe & Mazda MX6
1992 - 88
UNIT PACKAGE: 25



14738
(90467-09008)
Black Nylon
Retaining Clip
Toyota
UNIT PACKAGE: 25



20770
(Not Available From O.E.M.)
Yellow Nylon
Weatherstrip Retainer
Ford F Series Pick-Ups
2004 - On
UNIT PACKAGE: 100



21497
(1H0-837-719)
Black Nylon
Weatherstrip Retainer
With Clear Grommet
Audi A3 and VW Golf, Sharan,
Transporter & Corsa
UNIT PACKAGE: 25



18842
(90467-09006)
Black Nylon
Hood Insulation Retainer
Toyota Avalon, Camry & Lexus
1988 - On
UNIT PACKAGE: 15



19682
(91518-S10-003)
Black Nylon
Hood Seal Retaining Clip
Honda Odyssey
1999 - On
UNIT PACKAGE: 25



14723
(62869-N4700)
Black Nylon
Retaining Clip
Nissan
UNIT PACKAGE: 25



21588
(80850-CA003)
Black Nylon
Weatherstrip Retainer
Nissan Murano & Rouge
2003 - On
UNIT PACKAGE: 25



19114
(91518-SM4-003)
Black Nylon
Hood & Trunk Moulding
Retaining Clip
Acura Integra & Honda Civic
1994 - On
UNIT PACKAGE: 10



17205
(91501-SM4-003)
Black Nylon
Cowl Top Retaining Clip
Honda Accord
1990 - On
UNIT PACKAGE: 15



21307
(BP4K-58-762)
Black Nylon
Weatherstrip Retaining Clip
Mazda
2007 - On
UNIT PACKAGE: 25



21520
(J001-56-741)
Black Nylon
Weatherstrip Retaining Clip
Mazda CX-7, Millenia,
MPV, 3, 6 & 626
1995 - On
UNIT PACKAGE: 25



16777
(Mazda: B001-68-302-00;
Toyota: 90950-01248)
Black Nylon
Retaining Clip
Mazda & Toyota
UNIT PACKAGE: 25

Sec. 19**TRIMMING SUNDRIES & FASTENERS**

Refer to Retainer Specification Chart on pages 404 - 413

**14353**(76906-T3000)
Black NylonRetaining Clip
Nissan

UNIT PACKAGE: 50

**14720**(HB-121467)
Black NylonRetaining Clip
Mitsubishi

UNIT PACKAGE: 25

**14319**(90687-671-0030)
Black NylonRetaining Clip
Honda

UNIT PACKAGE: 25

**19124**(90467-07096)
Black NylonSide Trim Panel
Retaining Clip
Toyota 4WD Truck
1989 - On

UNIT PACKAGE: 10

**14380**(8133-50-022)
Black NylonRetaining Clip
Mazda

UNIT PACKAGE: 25

**20543**(81126-37010)
Black NylonHood Insulation Retainer
Hyundai Elantra & Sonata
And Kia Optima
1995 - On

UNIT PACKAGE: 15

**14347**(Nissan: 01553-00202;
Toyota: 90467-10018)
Black NylonRetaining Clip
Nissan & Toyota

UNIT PACKAGE: 50

**21105**(001-988-03-25)
Black NylonHood Insulation Retainer
Mercedes
2002 - On

UNIT PACKAGE: 15

**14323**(38529-689A-6300)
Black NylonRetaining Clip
Honda

UNIT PACKAGE: 25

**21254**(90467-08136)
Black NylonFender Seal Retaining Clip
Toyota Yaris
2009 - On

UNIT PACKAGE: 25

**16779**(Honda: 74842-659-0030;
Toyota: 90467-12078)
Black NylonRetaining Clip
Honda & Toyota

UNIT PACKAGE: 25

**14356**(01553-00051)
Black NylonRetaining Clip
Nissan

UNIT PACKAGE: 50

**21551**(67869-12050)
Black NylonWeatherstrip Retainer
Toyota Corolla & Prius
2007 - 01

UNIT PACKAGE: 25

View the Auveco
Catalog on-line at
www.auveco.com.You can search by
Auveco part number,
description,
OEM number
and competitive
part number.

TRIMMING SUNDRIES & FASTENERS

Sec. 19

Refer to Retainer Specification Chart on pages 404 - 413



21509
(357-853-575)
White Nylon

Retainer With Gray Grommet
VW Golf, Jetta, Passat & Scirocco

UNIT PACKAGE: 25



19320
(MB696120)
White Nylon

Side Garnish &
Moulding Trim Retainer
Mitsubishi Eclipse
1994 - On

UNIT PACKAGE: 15



21488
(11610605)
Gray Nylon

Door Trim Panel Retainer
Chevrolet Cruze
2011 - On

UNIT PACKAGE: 25



20611
(90602-S7S-003)
Blue Nylon

Cowl Vent Retainer
Use With Auveco 20612
Honda Accord
2003 - On

UNIT PACKAGE: 25



21496
(357-853-585-A)
White Nylon

Trim Panel Retainer
With Nylon Grommet
VW Golf & Passat and Audi B3

UNIT PACKAGE: 15



21365
(13252118)
Blue Nylon

Door Panel Retainer
Cadillac, Chevrolet &
GMC
2010 - On

UNIT PACKAGE: 25



20576
(GM: 88969790;
Toyota: 75867-21010)
Yellow Nylon

Fender Flare Retainer
Pontiac Vibe &
Toyota Echo
2002 - On

UNIT PACKAGE: 25



18861
(90467-10162)
White Nylon

Scuff Plate Retainer
Toyota Celica
1993 - On

UNIT PACKAGE: 15



19719
(67921-32010)
White Nylon

Scuff Plate Retainer
Toyota Avalon, Camry & Corolla
1997 - On

UNIT PACKAGE: 15



20571
(MR435918)
White Nylon

Rocker Panel Retainer
Mitsubishi Montero
2001 - On

UNIT PACKAGE: 15



21252
(8E0-867-276)
White Nylon

Trim Panel Retainer
Audi 2002 - On

UNIT PACKAGE: 25



20881
(5482103)
White Nylon

Cowl Vent Retainer
With Sealer
Chevrolet Equinox &
Pontiac Torrent
2005 - On

UNIT PACKAGE: 10



20642
(000-990-57-92)
Gray Nylon

Door Panel
Retaining Clip
Mercedes-Benz

UNIT PACKAGE: 10



20460
(G043-50-742)
Black Nylon

Cowl Panel Retainer
With Sealer
Mazda 626
2000 - On

UNIT PACKAGE: 10

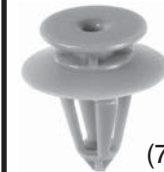

21495
(7L5-853-994)
Blue Nylon

Trim Panel Retainer
VW, Audi & Renault

UNIT PACKAGE: 25

Sec. 19**TRIMMING SUNDRIES & FASTENERS**

Refer to Retainer Specification Chart on pages 404 - 413

**21450**
(703-867-299)
Black NylonSide Panel & Interior
Trim Retainer
VW
2003 - 1993
UNIT PACKAGE: 25**19464**
(90667-SD4-003)
Natural NylonRoof Lining Retainer
Acura NSX, 2.2CL & 2.3CL
1991 - On

UNIT PACKAGE: 15

**18875**
(67771-16170)
White NylonDoor Trim
Panel Retainer
Toyota Tercel
1991 - On
UNIT PACKAGE: 25**21567**
(90913-0007)
Gray NylonPillar & Door Moulding
Trim & Rear Light Retainer
With Sealer
Subaru B9 Tribeca, Forester,
Impreza, Legacy & Outback
2005 - On

UNIT PACKAGE: 25

**21012**
(75867-AA010)
Black NylonRocker Panel &
Scuff Plate Retainer
Lexus ES300 & ES330
2002 - On
Toyota Avalon, Camry,
Scion & Solara
2004 - On

UNIT PACKAGE: 15

**20473**
(67771-12070)
White NylonDoor Panel &
Rocker Moulding Retainer
With Sealer
Lexus SC300/400
Toyota Avalon & Corolla
1992 - On

UNIT PACKAGE: 15

**21591**
(90913-0109)
Black NylonFront & Rear Door, Fender,
Quarter Panel and Rocker Panel
Moulding Clip
Subaru B9 Tribeca, Forester,
Impreza, Legacy & Outback
2003 - On

UNIT PACKAGE: 25

**21088**
(90321122)
White NylonDoor Panel Retainer
Saturn Ion
2003 - On

UNIT PACKAGE: 50

**19334**
(MB566720)
Natural NylonReal Pillar Trim &
Air Inlet Grille Retainer
Mitsubishi Eclipse
1994 - On

UNIT PACKAGE: 15

**21107**
(90602-SX0-003)
White NylonCowl Vent Retainer
Acura MDX, Honda Civic,
Insight, Odyssey & Prelude
1995 - On

UNIT PACKAGE: 10

**21489**
(11610606)
Yellow NylonDoor Trim Panel Retainer
Chevrolet Cruze
2011 - On

UNIT PACKAGE: 25

**20932**
(G18K-51-SJ3)
White NylonDoor Trim Panel Retainer
With Sealer
Mazda 3, 5, 6, CX-7,
Miata & Protege
2001 - On

UNIT PACKAGE: 10

**21364**
(13252119)
Green NylonDoor Panel Retainer
Buick, Cadillac, Chevrolet
& GMC
2010 - On

UNIT PACKAGE: 25

Refer to Retainer Specification Chart on pages 404 - 413



21412
(TD12-51-SJ3A)
Gray Nylon

Rocker Moulding Retainer
With Sealer
Mazda 6 GT
2010 - On

UNIT PACKAGE: 15



12565
(N801925-S)
Black Nylon

Door Trim
Panel Retainer
Ford
1981 - On

UNIT PACKAGE: 25



17218
(21042045,
21042053,
21042058,
21042104)
Natural Nylon

Door Trim Panel Retainer
GM Saturn
1991 - On

UNIT PACKAGE: 50



20829
(6505534-AA)
Black Nylon

Door Trim Panel Retainer
Chrysler Concorde, Intrepid,
LHS & 300M
1998 - On

UNIT PACKAGE: 50



17124
(N805155-S)
Black Nylon

Trim Panel Retainer
Ford
1985 - On

UNIT PACKAGE: 50



21091
(22691056)
Black Nylon

Tailgate Moulding Retainer
With Sealer
Cadillac Escalade EXT
And Chevrolet Avalanche
2007 - On

UNIT PACKAGE: 15



19810
(N807943-S)
Black Nylon

Trim Panel Retainer
Ford Mustang
1995 - On

UNIT PACKAGE: 50



13470
(N802900)
White Nylon

Door Trim Panel Retainer
Ford

UNIT PACKAGE: 25



20274
(Not Supplied
By O.E.M.)
White Nylon

Door Panel Retainer
Use With Auveco 20275
Chrysler LH Series
2000 - On

UNIT PACKAGE: 25



19213
(6503709)
Natural Nylon

Trim Panel Retainer
Dodge Ram
1994 - On

UNIT PACKAGE: 50



18848
(F58Z-16237A02-A)
Yellow Nylon

Door Trim Panel Retainer
Ford Windstar
1995 - On

UNIT PACKAGE: 25



19802
(MB566719)
White Nylon

Door Moulding Retainer
Chrysler Concorde,
Eagle Talon & Sebring
1996 - On

UNIT PACKAGE: 15

Sec. 19

TRIMMING SUNDRIES & FASTENERS

Refer to Retainer Specification Chart on pages 404 - 413



17102

(GM: 10143422;
Ford: N805612-S100;
AMC: 8934-202-599)
White Nylon

Trim Panel Retainer
Ford Tempo & Topaz, Jeep Eagle
& Premier and Pontiac
1988 - On

UNIT PACKAGE: 50



21532

(Not Available
From O.E.M.)
White Nylon

Front Bumper Cover Retainer
GM Trucks
2008 - On

UNIT PACKAGE: 25



21383

(11561499)
White Nylon

Trim Panel Retainer
Use with Auveco #21384
Chevrolet Traverse
2010 - On

UNIT PACKAGE: 25



20944

(11588863)
Green Nylon

Door Trim Panel Retainer
Buick Terraza, Chevrolet
Uplander, Pontiac Montana
& Saturn Relay
2005 - On

UNIT PACKAGE: 25



11671

(387182-S)
Black Nylon

Seat Back
Panel Retainer
Ford
1977 - On

UNIT PACKAGE: 25



20995

(11562043)
White Nylon

Door Panel Retainer
With Sealer
Cadillac SRX & STS, Chevrolet
Cobalt & HHR and Hummer H3
2004 - On

UNIT PACKAGE: 15

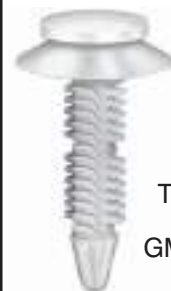

18391

(15694099)
Natural Nylon

Rear Door
Trim Panel Retainer
Chev. Astro &
GMC Safari Mini Vans
1993 - On

UNIT PACKAGE: 15



18175

(10158124)
Natural Nylon

Trim Panel Retainer
GM, Chrysler
1992 - On

UNIT PACKAGE: 50



21516

(357-853-585)
White Nylon

Retainer With
Black Nylon
Grommet
VW Golf A2 & A3 and Audi

UNIT PACKAGE: 25



20996

(11562044)
Yellow Nylon

Door Panel Retainer
With Sealer
Cadillac SRX & STS, Chevrolet
Cobalt & HHR and Hummer H3
2004 - On

UNIT PACKAGE: 15



21346

(10350983)
White Nylon

Trim Panel Retainer
With Sealer
Mates With
Auveco No. 21347
Cadillac, Chevrolet
& Pontiac
2004 - On

UNIT PACKAGE: 15



20634

(GM: 10363811;
22722859)
White Nylon

Door Panel Retainer
Use With Auveco 20635
Oldsmobile Alero &
Pontiac Grand Am
2002 - On

UNIT PACKAGE: 25

Please E-mail Your
New Item Suggestions
To: mail@auveco.com

TRIMMING SUNDRIES & FASTENERS

Sec. 19

Refer to Retainer Specification Chart on pages 404 - 413



20998
(11562256)
Black Nylon Pin
& White Nylon Grommet

Door Panel Retainer
With Sealer
Chevrolet Cobalt, HHR
& Full-Size Van
2005 - On

UNIT PACKAGE: 15



21536
(1157119)
Yellow Nylon

Door Panel Retainer & Grommet
Buick Enclave & Lucerne, Cadillac
DTS, Chevrolet Cobalt, Colorado,
Traverse, GM "G" Vans, GMC Acadia
& Canyon and Pontiac G5 & Pursuit
2008 - On

UNIT PACKAGE: 15



16938
(15638413, 15963179)
Black Nylon

Trim Panel Retainer
Overall Length: 29/32"
GM Trucks 1991 - On

UNIT PACKAGE: 50



11797
(387477-S)
White Nylon

Interior Trim Panel
Overall Length; 15/16"
Ford
1977 - On

UNIT PACKAGE: 50



20999
(11562257)
Green Nylon
Pin & Yellow Nylon
Grommet

Door Panel Retainer
With Sealer
Chevrolet Cobalt & HHR
2006 - On

UNIT PACKAGE: 15



19527
(10408480)
Yellow Nylon

Door Garnish Moulding &
Pillar Trim Panel Retainer
Overall Length: 25/32"
Buick Century & Regal, Chev.
Venture, Olds Intrigue & Silhouette,
Pontiac Grand Prix
and Trans Sport
1997 - On

UNIT PACKAGE: 25



19356
(15986673)
White Nylon

Front & Rear Door
Trim Panel Retainer
Overall Length: 1-3/32"
GM Trucks S10 & S15
1996 - On

UNIT PACKAGE: 50



21535
(11571118)
White Nylon

Door Panel Retainer & Grommet
Buick Enclave & Lucerne, Cadillac
DTS, Chevrolet Traverse, GM "G"
Vans, GMC Acadia and Hummer H2
2008 - On

UNIT PACKAGE: 15



19275
(10287971)
White Nylon

Door Trim Panel Retainer
Overall Length: 25/32"
Buick Century & Regal,
Chevrolet Venture, Olds
Silhouette and Pontiac
Trans Sport
1997 - On

UNIT PACKAGE: 50



17075
(389144-S)
White Nylon

Trim Panel Retainer
Overall Length: 1-5/32"
Ford
1981 - On

UNIT PACKAGE: 50

Sec. 19**TRIMMING SUNDRIES & FASTENERS**

Refer to Retainer Specification Chart on pages 404 - 413

**19270**
(10285935)
White NylonTrim Panel Retainer
Overall Length: 1-3/16"
Buick Century & Regal
Chevrolet Venture,
GM Truck
Express/Savana, Olds
Silhouette & Pontiac
Trans Sport
1997 - On

UNIT PACKAGE: 50

**21137**
(07-13-0-702-516)
Black NylonRear Quarter Wheel Opening
Moulding Retaining Clip
Overall Length: 14mm
Mini-Cooper
2002 - On

UNIT PACKAGE: 25

**20670**
(01553-02821)
Gray NylonTrim Panel Retainer
Overall Length: 16mm
Nissan Maxima
1988 - On

UNIT PACKAGE: 15

**20814**
(10305191)
White NylonDoor Panel Retainer
Overall Length: 1-3/16"
Chevrolet Impala, Lumina
& Monte Carlo
2000 - On

UNIT PACKAGE: 50

**18824**
(G350-68-AB1)
White NylonTrim Panel Retainer
Overall Length: 16mm
Mazda 626, MX-6,
Millenia, MX3, 929,
Protégé, MPV
Ford Probe
1990 - On

UNIT PACKAGE: 50

**21410**
(90467-09212)
White NylonCowl Trim Retainer
Overall Length: 16mm
Toyota Camry
2010 - On

UNIT PACKAGE: 25

**16695**
(10153057)
White NylonDoor Trim
Panel Retainer
Overall Length: 1-1/4"
GM
1982 - On

UNIT PACKAGE: 25

**21584**
(69300-5370)
White NylonFront Door & Lift Gate
Trim Panel Retainer
Overall Length: 16mm
Subaru Impreza, Justy, Legacy &
Outback
2007 - 1987

UNIT PACKAGE: 25

**20558**
(62217-13010)
White NylonGarnish Moulding Retainer
Overall Length: 17mm
Lexus and Toyota Corolla,
Matrix & 4 Runner
2003 - On

UNIT PACKAGE: 25

**20338**
(10421018)
White NylonDoor Trim
Panel Retainer
Overall Length: 1-9/16"
GM
1997 - On

UNIT PACKAGE: 25

**20459**
(GA2A-68-AB1A)
Black NylonTrim Panel Retainer
Overall Length: 16mm
Mazda 626
2000 - On

UNIT PACKAGE: 10

**21188**
(82315-27000)
Pink NylonTrim Panel Retainer
Overall Length: 17mm
Hyundai &
Kia 2003 - On

UNIT PACKAGE: 15

TRIMMING SUNDRIES & FASTENERS

Sec. 19

Refer to Retainer Specification Chart on pages 404 - 413



21149
(91560-S84-A01)
White Nylon

Trim Panel Retainer
Overall Length: 17.5mm
Honda Accord & Element
2003 - On

UNIT PACKAGE: 25



21574
(90913-0034)
White Nylon

Door, Pillar, Rocker, Floor & Interior
Trim Retainer
Overall Length: 18mm
Subaru Baja, Forester, Legacy &
Outback
2008 - 03

UNIT PACKAGE: 25



19466
(91560-SZ3-003)
White Nylon

Door Trim Panel Retainer
Overall Length: 18mm
Acura 3.5RL
1996 - On

UNIT PACKAGE: 15



20559
(GM: 88970345;
Toyota: 90467-10167)
Blue Nylon

Garnish Moulding Retainer
Overall Length: 17.5mm
Pontiac Vibe, Lexus and Toyota
2000 - On

UNIT PACKAGE: 25



21139
(07-14-7-145-753)
White Nylon

Body Side Moulding Retainer
With Sealer
Overall Length: 18mm
Mini-Cooper
2002 - On

UNIT PACKAGE: 25



21070
(Hyundai:
82315-38000
GM: 94530565)
White Nylon

Trim Panel Retainer
Overall Length: 18mm
Chevrolet Aveo 2004 - On
Hyundai Accent, Santa Fe, Sonata
Tiburon & XG300/350 1999 - On
And Kia Optima, Rio &
Sorento
2001 - On

UNIT PACKAGE: 25



21240
(10369649)
Green Nylon

Door Panel Retainer
With Sealer
Overall Length: 17.5mm
Pontiac Torrent
2006 - On

UNIT PACKAGE: 25



21638
(91560-S0X-A01)
White Nylon

Trim Panel Retainer
With Sealer
Overall Length: 18mm
Honda Accord, CR-V, Fit
& Odyssey
1999 - On

UNIT PACKAGE: 15



20983
(GJ6R-68-ABX)
White Nylon

Trim Panel Retainer
With Sealer
Overall Length: 18mm
Mazda 3, 5, 6, Miata & RX-8
2003 - On

UNIT PACKAGE: 15



19109
(67771-30070)
Natural Nylon

Door Trim Panel
& Garnish Retainer
Overall Length: 18mm
Toyota Corolla Wagon, Tercel
T-100 & Tacoma 2WD
1992 - On

UNIT PACKAGE: 25



21675
(91560-SZW-003)
Green Nylon

Door Panel & Interior Trim Retainer
Overall Length: 18mm
Honda Civic
2012 - On

UNIT PACKAGE: 25



21208
(91560-SLJ-J01)
Gray Nylon

Door Trim Panel Retainer
Overall Length: 18mm
Acura RDX and Honda
Civic, CR-V & Pilot
2009 - On

UNIT PACKAGE: 10

Refer to Retainer Specification Chart on pages 404 - 413



19731

(84915-0W000)
White Nylon

Trim Panel Retainer
Overall Length: 18.5mm
Nissan Pathfinder
1995 - On

UNIT PACKAGE: 15



19145

(91560-SP0-003)
Gray Nylon

Front & Rear Door
Trim Panel Retainer
Overall Length: 18.5mm
Acura Integra & Legend
Honda Accord, Civic,
Prelude, Odyssey & Del Sol
1991 - On

UNIT PACKAGE: 25



21414

(80999-VE000)
White Nylon

Trim Panel Retainer With Sealer
Overall Length: 19.5mm
Infiniti & Nissan
1993 - On

UNIT PACKAGE: 25



19203

(67771-89104)
Natural Nylon

Quarter Board
Inside Trim Panel Retainer
Overall Length: 18.5mm
Toyota Truck 2WD
1997 - 91

UNIT PACKAGE: 15



20959

(91560-S9A-A01)
Blue Nylon

Door Panel Retainer
Overall Length: 19mm
Acura TL & TSX and
Honda Accord, Civic, CRV &
Odyssey
2002 - On

UNIT PACKAGE: 25



20575

(Toyota: 67771-12080;
GM: 88970656)
Yellow & White Nylon

Door Panel & Rocker
Moulding Retainer
Overall Length: 19.5mm
Toyota & Lexus
1998 - On
Pontiac Vibe
2003 - On

UNIT PACKAGE: 15



20411

(91560-S84-A11)
Black Nylon

Windshield Garnish
Pillar Retainer
Overall Length: 18.5mm
Acura 3.2CL, Honda Accord,
Insight & Odyssey
1998 - On

UNIT PACKAGE: 15



21676

(91560-SZW-J01)
Yellow Nylon

Windshield Moulding
& Interior Trim Retainer
Overall Length: 19mm
Honda Civic
2012 - On

UNIT PACKAGE: 25



21206

(91560-S6A-003)
Orange Nylon

Rear Liftgate Retainer
Overall Length: 19.5mm
Honda Fit
2009 - On

UNIT PACKAGE: 15



21554

(91560-S7A-003)
Black Nylon

Trim Panel Retainer With Sealer
Overall Length: 18.5mm
Honda Crosstour, Fit & Odyssey
2010 - 05

UNIT PACKAGE: 25



21360

(85849-3B000)
White Nylon

Headliner & Trim Panel Retainer
Overall Length: 19.5mm
Hyundai
2001 - On

UNIT PACKAGE: 25



20879

(007-988-99-78,
007-988-34-78)
Green Nylon

Door Trim Panel Retainer
Overall Length: 19.5mm
Mercedes-Benz
1996 - On

UNIT PACKAGE: 10

Refer to Retainer Specification Chart on pages 404 - 413



20668

(01553-09791)
White Nylon

Trim Panel Retainer
Overall Length: 20mm
Nissan & Infiniti
1999 - On

UNIT PACKAGE: 15



20437

(90467-09206)
White Nylon

Trim Panel Retainer
With Sealer
Overall Length: 20mm
Toyota RAV 4 & Tundra
2000 - On

UNIT PACKAGE: 15



21102

(90467-A0005)
White Nylon

Door Trim Panel Retainer
With Sealer
Overall Length: 20mm
Lexus ES 350, GX 470, IS 250,
IS 350, IS F, LS 460 & LS 600HL
And Toyota Camry, FJ Cruiser,
Highlander, RAV4 & 4-Runner
2001 - On

UNIT PACKAGE: 15



18844

(67771-06010,
67771-32090)
White Nylon

Trim Panel Retainer
Overall Length: 20mm
Cowl Side & Garnish
Center Pillar Retainer
Toyota Camry
1991 - On

UNIT PACKAGE: 10



21654

(Not Available From O.E.M.)
White Nylon

Trim Panel Retainer
Overall Length: 20mm
Lincoln MTX
2012 - On

UNIT PACKAGE: 25



18950

(90467-10168)
Black & White Nylon

Garnish Retainer
Overall Length: 20mm
Toyota Avalon & Camry
1991 - On

UNIT PACKAGE: 5



21329

Black Nylon
(68061648-AA)

Tail Light Retainer
Overall Length: 20mm
Dodge Ram
2009 - On

UNIT PACKAGE: 15



14728

(67771-22020)
Natural & Yellow Nylon

Door Panel Retainer
Overall Length: 20mm
Toyota

UNIT PACKAGE: 25



21289

(84953-JA00A)
Yellow Nylon

Trim Panel Retainer
Overall Length: 20mm
Nissan Altima
2010 - On

UNIT PACKAGE: 25



20633

(90467-10188)
Turquoise Nylon

Trim Panel Retainer
Overall Length: 20mm
Toyota Sienna
2004 - On

UNIT PACKAGE: 25



14269

(Isuzu: 8942264920;
Mazda: 9927-40-825;
Toyota: 67771-01010,
67771-12010)
White Nylon

Door Panel Retainer
Overall Length: 20.5mm
Isuzu, Mazda & Toyota

UNIT PACKAGE: 25



21138

(51-43-7-001-491-2)
White Nylon

Headliner Retainer
Overall Length: 20.5mm
Mini-Cooper
2005 - On

UNIT PACKAGE: 25

Sec. 19**TRIMMING SUNDRIES & FASTENERS**

Refer to Retainer Specification Chart on pages 404 - 413

**15709**
(67771-02030)
Natural NylonDoor Trim Retainer
Overall Length: 20.5mm
Toyota Corolla
1990 - On

UNIT PACKAGE: 50

**14270**
(67771-22010)
Blue & Natural NylonDoor Panel Retainer
Overall Length: 20.5mm
Toyota

UNIT PACKAGE: 25

**15707**
(67771-03030)
Gray NylonDoor Trim Retainer
Overall Length: 20.5mm
Toyota Camry
1988 - On

UNIT PACKAGE: 50

**18876**
(Toyota: 90467-10161;
GM: 94858299)
White NylonTrim Board Retainer
Overall Length: 20.5mm
Sienna, Solara & Tercel
1990 - On
Geo Prizm & Pontiac Vibe
1998 - On

UNIT PACKAGE: 25

**14144**
(GM: 95005064;
Toyota: 67771-01010)
Black NylonTrim Panel Retainer
Overall Length: 20.5mm
Toyota & GM

UNIT PACKAGE: 25

**19898**
(67771-02030)
Yellow NylonTrim Panel Retainer
Overall Length: 20.5mm
Toyota Corolla
1990 - On

UNIT PACKAGE: 50

**21502**
(90913-0213)
White NylonDoor Trim Panel Retainer
With Sealer
Overall Length: 20.5mm
Subaru Legacy & Outback
2010 - On

UNIT PACKAGE: 10

**20669**
(01553-07111)
Black NylonTrim Panel Retainer
Overall Length: 20.5mm
Nissan Altima and Infiniti G35 & Q45
1997 - On

UNIT PACKAGE: 25

**19910**
(90467-08179)
Yellow NylonGarnish Retainer
Overall Length: 20.5mm
Toyota Tundra
1999 - On

UNIT PACKAGE: 25

**21118**
(MB374270, MB374271)
White NylonTrim Panel Retainer
Overall Length: 20.5mm
Chrysler Laser, Stealth,
Jeep Eagle & Talon and
Mitsubishi Eclipse & Montero
1989 - On

UNIT PACKAGE: 15

**21640**
(84953-AU100)
Black NylonDoor Trim Panel Retainer
With Sealer
Overall Length: 20.5mm
Infiniti FX35, FX45, G35 & G37
2008 - 03

UNIT PACKAGE: 15

**21087**
(90602-SAA-003)
Orange NylonCowl Vent &
Radiator Support Retainer
Overall Length: 20.5mm
Honda Fit & CRV
2003 - On

UNIT PACKAGE: 15

TRIMMING SUNDRIES & FASTENERS

Sec. 19

Refer to Retainer Specification Chart on pages 404 - 413



19257

(GM: 30006620;
Toyota: 67771-12050;
Suzuki: 09409-08320)
Maroon Nylon

Cowl Vent Screen &
Door Trim Panel Retainer
Overall Length: 20.5mm
Chevrolet Geo, Metro & Tracker,
Lexus and Toyota Celica,
Corolla & Previa
1989 - On

UNIT PACKAGE: 15



20515

(6505918-AA)
Yellow & White Nylon

Trim Panel Retainer
Overall Length: 21mm
Chrysler Caravan, Town & Country
And Voyager Mini-Vans
2001 - On

UNIT PACKAGE: 25



21059

(90602-S5A-003)
Blue Nylon

Cowl Vent Retainer
Overall Length: 21mm
Acura RSX and Honda Civic & CR-V
2001 - On

UNIT PACKAGE: 15



19108

(67771-16080)
Natural Nylon

Door Trim Panel
& Back Panel
Upper Garnish Retainer
Overall Length: 21mm
Toyota Truck
1988 - On

UNIT PACKAGE: 10



18874

(67771-16120)
Gray Nylon

Front & Rear Door
Trim Panel Retainer
Overall Length: 21mm
Toyota Tercel
1994 - On

UNIT PACKAGE: 15



18915

(6504014)
White Nylon

Door Trim
Panel Retainer
Overall Length: 21.5mm
Chrysler Caravan
Cirrus, Neon, Ram Truck,
Stratus & Voyager
1995 - On

UNIT PACKAGE: 50



20610

(Honda: 91560-SM4-003)
White Nylon

Door Trim Panel Retainer
Overall Length: 21mm
Honda Accord
1990 - On

UNIT PACKAGE: 25



19016

(67771-12040)
Dark Gray Nylon

Door Trim Panel Retainer
Overall Length: 21mm
Toyota Cressida
1992 - 88

UNIT PACKAGE: 15



17669

(6502907, 6504452)
Yellow Nylon

Trim Panel Retainer
Overall Length: 21.5mm
Jeep Grand Cherokee
& Dodge Truck
1993 - On

UNIT PACKAGE: 50



19386

(6505292AA)
Natural Nylon

Door Trim Panel Retainer
Overall Length: 21mm
Chrysler Vans
1998 - On

UNIT PACKAGE: 25



21247

(W709995-S300)
Green Nylon

Lift Gate Trim Retainer
Overall Length: 21mm
Ford Flex
2009 - On

UNIT PACKAGE: 25



19210

(67771-04040)
Natural Nylon

Front Door Trim Panel Retainer
Overall Length: 22mm
Toyota Tacoma
1995 - On

UNIT PACKAGE: 50

Refer to Retainer Specification Chart on pages 404 - 413



18294

(91566-SP0-003)
White Nylon

Trim Panel Retainer
Overall Length: 22mm
Honda
1990 - On

UNIT PACKAGE: 15



21250

(Not Available
From O.E.M.)
Black Nylon

Seat Back & Trim Panel Retainer
Overall Length: 23mm
Jeep Commander
2006 - On

UNIT PACKAGE: 25



20190

(W708621-S300)
Caramel & Natural Nylon

Trim Panel Retainer
Overall Length: 25mm
Ford Taurus & Sable
2000 - On

UNIT PACKAGE: 25



19628

(5012874-AA, 6505539-AA)
White Nylon

Door Trim Panel Retainer
Overall Length: 22mm
Jeep Grand Cherokee
1999 - On

UNIT PACKAGE: 25



20765

(6507055-AA,
6507686-AA)
Yellow Nylon

Door Panel Retainer
Overall Length: 23mm
Jeep Grand Cherokee
2003 - On

UNIT PACKAGE: 50



20949

(W711037-S300)
Black & Blue Nylon

Door Trim Panel Retainer
Overall Length: 25mm
Ford Edge, Escape, Freestyle
Mariner, Montego & 500
2005 - On

UNIT PACKAGE: 25



21333

(11561654)
Blue Nylon

Cowl, Pillar, Trim Panel
& Windshield Retainer
Overall Length: 22mm
GM
2006 - On

UNIT PACKAGE: 15



19129

(GM: 95008221;
Toyota: 67771-30090;
Chrysler & Mitsubishi:
MB608104)
Yellow Nylon

Door Trim Panel & Back Panel
Lower Garnish Retainer
Overall Length: 23.5mm
Toyota Land Cruiser & 2WD Truck
1991 - On
Geo Prism
1997 - 93

UNIT PACKAGE: 15



21131

(90602-SEP-A00)
Black Nylon

Trim Panel Retainer
Overall Length: 25.5mm
Acura TL
2007 - On

UNIT PACKAGE: 15



18862

(6503204)
Green Nylon

Trim Panel Retainer
Overall Length: 23mm
Chrysler Cirrus & Stratus
1995 - On

UNIT PACKAGE: 50



20428

(5028438-AA)
Green & White Nylon

Door Trim Panel Retainer
Overall Length: 24.5mm
Chrysler Vans
2001 - On

UNIT PACKAGE: 25



20444

(15076791)
White Nylon

Trim Panel Retainer
Overall Length: 26mm
GM Trucks: Rendezvous, S & T
2002 - On

UNIT PACKAGE: 15

Refer to Retainer Specification Chart on pages 404 - 413



20616

(GM: 11519031;
Ford: W711521-S300)
White Nylon

Door Panel Retainer
With Sealer
Overall Length: 26mm
Hummer H2
2003 - On
Lincoln
2007 - On

UNIT PACKAGE: 15



20427

(6505759-AA)
Gray & White Nylon

Door Trim Panel Retainer
With Sealer
Overall Length: 26mm
Chrysler Vans
2001 - On

UNIT PACKAGE: 25



21379

(15931605)
Black Nylon

Cowl Grille Retainer w/Sealer
Overall Length: 26mm
Chevrolet Traverse
2010 - On

UNIT PACKAGE: 10



21169

(W713297-S300)
White Nylon

Door Trim Panel Retainer
With Sealer
Overall Length: 28mm
Ford Flex
2009

UNIT PACKAGE: 25



21189

(11519032)
Black Nylon

Trim Panel Retainer
Overall Length: 28mm
Buick Lucerne & Rainier,
Cadillac DTS, Escalade & SPX,
Chevrolet Avalanche, Malibu,
Silverado, Tahoe & Trailblazer,
GMC Envoy, Sierra, Suburban &
Yukon, Hummer H2, H3 & H3T,
Oldsmobile Bravada
And Pontiac G6
2002 - On

UNIT PACKAGE: 10



18930

(22600612,
22651066)
Yellow Nylon

Trim Panel Retainer
Overall Length: 28mm
GM
1996 - On

UNIT PACKAGE: 25



20563

(5023173-AA)
White Nylon

Door Trim Panel
Retainer
Overall Length: 30mm
Jeep Liberty
2002 - On

UNIT PACKAGE: 15



17685

(6502991)
Yellow Nylon

Trim Panel &
Tail Gate Retainer
Overall Length: 31.5mm
Jeep Cherokee
1993 - On

UNIT PACKAGE: 25



19775

(55350747AB)
White Nylon

Door Trim Panel Retainer
With Sealer
Chrysler Mini-Vans
1999 - On

UNIT PACKAGE: 15



20946

(W711017-S300)
Black Nylon

Door Trim Panel Retainer
With Sealer
Ford Fusion
2006 - On

UNIT PACKAGE: 10



19428

(22646099)
White Nylon

Trim Panel Retainer
With Sealer
Chevrolet Cavalier &
Pontiac Sunfire
1995 - On

UNIT PACKAGE: 25

Refer to Retainer Specification Chart on pages 404 - 413



19758
(25704141)
Green Nylon

Trim Panel Retainer
With Sealer
Buick LeSabre &
Pontiac Bonneville
2000 - On

UNIT PACKAGE: 10



21494
(VW: 171-807-249-A)
Natural Nylon

Trim Panel Retainer
VW Golf & Audi
1978 - On

UNIT PACKAGE: 25



20252
(823-867-299)
Black Nylon

Trim Panel Retainer
VW Corrado, Eurovan, Jetta,
Rabbit & Vanagon
1979 - On

UNIT PACKAGE: 25



20735
(463-988-02-78)
Black Nylon

Door Panel Retainer
Mercedes-Benz G55 & G500
2002 - On

UNIT PACKAGE: 25



11349
(AMC: 4005099;
GM: 796255;
Chry: 6033862)
Black Nylon

Door Panel Retainer
American Motors
1976 - On
GM
1988 - 81
Jeep Wrangler
1991 - On

UNIT PACKAGE: 25



14363
(9927-40-821)
Natural Nylon

Door Panel Retainer
Mazda

UNIT PACKAGE: 25



13475
(Renault: 8934-201-681;
VW: 175-867-299)
White Nylon

Trim Panel Retainer
AMC-Renault
1984 - On
VW
1982 - On

UNIT PACKAGE: 50



13179
(BMW: 51-41-8-172-050;
VW: 481-867-197)
Black Nylon

Trim Panel Retainer
VW & BMW

UNIT PACKAGE: 50



16778
(Mazda: 9927-40-822;
Toyota: 62581-14020)
Natural Nylon

Trim Panel Retainer
Mazda & Toyota

UNIT PACKAGE: 25



13945
(01553-S3500)
White Nylon

Door Trim Panel Retainer
Nissan Trucks

UNIT PACKAGE: 50



19804
(5023111AA)
White Nylon

Trim Panel Retainer
With Sealer
Dodge Neon
2000 - On

UNIT PACKAGE: 15



19759
(25696693)
White Nylon

Trim Panel Retainer
With Sealer
Cadillac DeVille & Seville
1998 - On

UNIT PACKAGE: 10



20188
(003-988-41-78)
White Nylon

Trim Panel Retainer
Mercedes-Benz
Body Styles 107, 108, 109,
114, 115, 123 & 124
1995 - 68

UNIT PACKAGE: 10

Refer to Retainer Specification Chart on pages 404 - 413



16017
(363137)
White Nylon

Trim Panel Retainer
Chev. Truck & GMC
1976 - On

UNIT PACKAGE: 100

15461

Same as 16017 except for packing

UNIT PACKAGE: 50



11678
(Chry: 6003349;
GM: 9685057;
AMC: 4005470;
VW: N98905101)
White Nylon

Door Trim Panel Retainer
Chrysler, GM, AMC & VW
1976 - On

UNIT PACKAGE: 25



13453
(20480475)
White Nylon

Rear Quarter
Panel Retainer
GM

UNIT PACKAGE: 50



13461
(20451401)
White Nylon

Retains Conduit To
Sheet Metal In Doors
GM

UNIT PACKAGE: 25



11672
(387496-S)
White Nylon

Trim Panel Retainer
Ford
1976 - On

UNIT PACKAGE: 25



15669
(10126901)
White Nylon

Trim Panel Retainer
GM
1987-On

UNIT PACKAGE: 50



20253
(51-41-1-973-500)
White Nylon

Trim Panel Retainer
BMW Series 3, 5 & 7
1987 - On

UNIT PACKAGE: 50



10621
(2064891,
9818648,9883583)
White Nylon

Door Trim Panel &
Headliner Retainer
GM
1971-On

UNIT PACKAGE: 50

16260

Same as 10621 except for packing

UNIT PACKAGE: 100



11774
(9883583)
White Nylon

Door Trim
Panel Retainer
GM
1971-On

UNIT PACKAGE: 50



12737
(12337920,
20374473)
White Nylon

Door Panel Retainer
Camaro & Firebird
1982-On
GM Truck
1989-On

UNIT PACKAGE: 50

14524

Same as 12737 except for packing

UNIT PACKAGE: 25



11796
(3065575)
White Nylon

Door Trim
Panel Retainer
GM
1978-On

UNIT PACKAGE: 50

16261

Same as 11796 except for packing

UNIT PACKAGE: 100



13992
(20429451)
White Nylon

Door Trim
Panel Retainer
GM
1984-On

UNIT PACKAGE: 25

Refer to Retainer Specification Chart on pages 404 - 413



11677

(GM: 20298365;
Chry: 6013122)
Natural Nylon

Trim Panel Retainer
Chrysler
1976-On
GM
1982-On

UNIT PACKAGE: 50



12992

(10073833,
15600382,
20421800)
White Nylon

Door Trim Panel Retainer
GM
1983-On

UNIT PACKAGE: 25



18936

(N811006-S)
Natural Nylon

Trim Panel Retainer
Ford
1995-On

UNIT PACKAGE: 25



17649

(15953247)
White Nylon

Trim Panel Retainer
GM C & K Trucks
1993-On

UNIT PACKAGE: 50



13946

(15588024,
15596301)
Yellow Nylon

Side & Rear Door
Trim Retainer
GM Astro & Safari
Mini-Vans
1985-On

UNIT PACKAGE: 25



19398

(12535713)
Natural Nylon

Quarter Trim
Panel Retainer
Buick Riviera
1995-On

UNIT PACKAGE: 25



20279

(25672428)
White Nylon

Trim Panel Retainer
With Sealer
Buick LeSabre & Park Ave.,
Cadillac DeVille & Seville,
Oldsmobile Aurora &
Pontiac Bonneville
1998 - On

UNIT PACKAGE: 10



17092

(20734005)
Yellow Nylon

Door Trim
Panel Retainer
GM
1982-On

UNIT PACKAGE: 50



14758

(D9AB-74519
B18-AA)
White Nylon

Roof Liner Moulding
Retainer
Ford Taurus &
Sable
1986-On

UNIT PACKAGE: 25



15670

(15545202)
White Nylon

Door Trim Panel Retainer
GM Trucks
1988-On

UNIT PACKAGE: 50



15970

(15607165,
15612948)
White Nylon

Trim Panel Retainer
GM Trucks
1976-On

UNIT PACKAGE: 25



20341

(3B0-868-243)
Black Nylon

Door Trim Panel Retainer
VW Beetle, Golf, Jetta & Passat
1998 - On

UNIT PACKAGE: 25

TRIMMING SUNDRIES & FASTENERS

Sec. 19

Refer to Retainer Specification Chart on pages 404 - 413



21398
(VW: 6K0-868-243-C)
Black Nylon
Trim Panel Retainer
Audi and Volkswagen Touareg
2004 - On

UNIT PACKAGE: 25



21415
(VW: 1H0-868-243-B)
Tan and White Nylon
Adjustable Door
Trim Panel Retainer

VW Golf
2002 - 1993

UNIT PACKAGE: 25



20762
(Not Available
From O.E.M.)
Black Nylon
Grille & Shroud Retainer
Ford Explorer & Mountaineer
2003 - On

UNIT PACKAGE: 25



21144
(VW:
8E0-868-243)
Black Nylon
Interior Trim Panel
Retainer with Sealer
Audi A4 & S4, Avant,
Sedan Wagon, Cabriolet &
Quattro
2005 - On

UNIT PACKAGE: 25



19524
(N807875-S)
Green Nylon
Door Trim Panel Retainer
Lincoln Continental
1995 - On

UNIT PACKAGE: 25



20866
White Nylon
Double End Retainer
Marine & Automotive Trim Shops

UNIT PACKAGE: 25



21393
(VW: 1H0-868-243)
Green & Black Nylon
Trim Retainer
Audi and Volkswagen Cabrio
Golf & Jetta
1999 - 1993

UNIT PACKAGE: 25



21023
(6503336)
Black Nylon
Cowl Screen Retainer
Use With Auveco 18249
Dodge Ram
1994 - On

UNIT PACKAGE: 25



17599
(15672328)
Black Nylon
Radiator Grille
Retainer
GM S-10 & S-15 Pick-Ups
1991-On

UNIT PACKAGE: 25

Sec. 19

RETAINER SPECIFICATION CHART

Recommended Hole Size: .030"-.060" smaller than stem diameter.

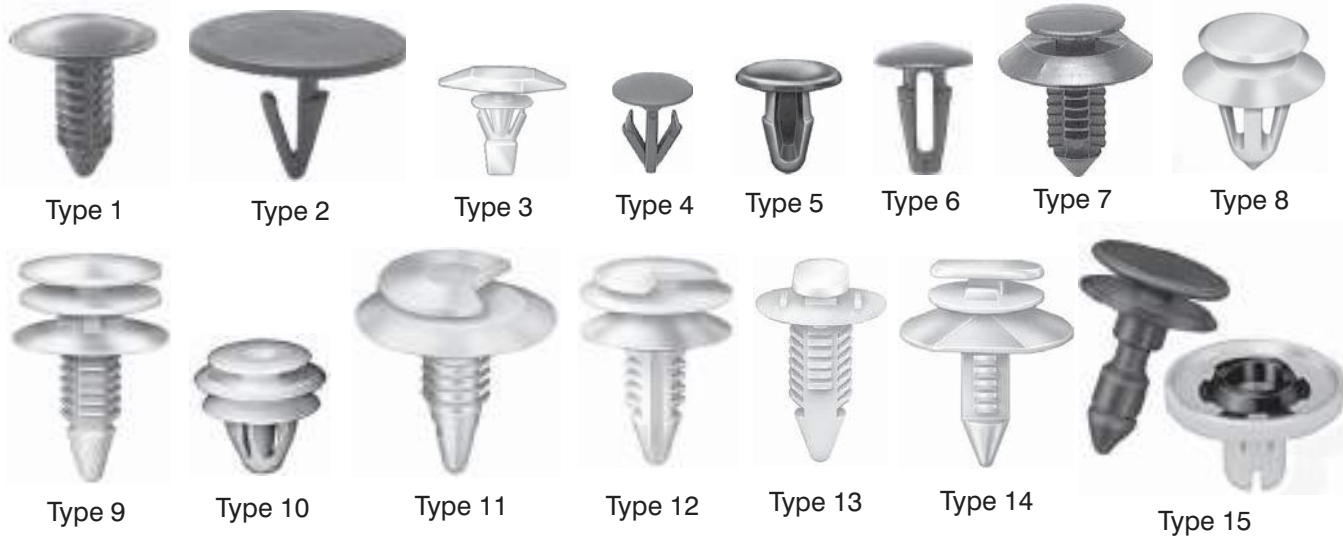

Auveco Part No.	Type	Color	Bottom Head Diameter	Top Head Diameter	Stem Diameter	Stem Length	Page No.
3620	5	Black	13/32"		9/64"	7/16"	382
3639	5	White	3/8"		7/32"	7/16"	382
5592	5	Black	1/2"		9/32"	5/8"	383
8853	3	Natural	3/16" x 1/2"		3/16"	5/8"	380
10332	1	Black	1-1/4"		5/16"	1/2"	373
10621	12	White	3/4"	11/16"	5/16"	1/2"	401
10744	3	Black	3/16" x 1/2"		3/16"	7/16"	379
10831	1	Black	11/16"		5/16"	5/8"	371
10832	1	Gray	11/16"		5/16"	5/8"	371
11120	1	Black	13/32"		5/32"	3/8"	365
11129	1	Black	3/8"		7/32"	3/8"	365
11130	1	Black	.2"		5/16"	3/4"	377
11136	2	Black	1/2" x 1-1/2"		9/32"	5/8"	382
11146	1	Black	11/16"		5/16"	13/16"	371
11347	1	Black	3/4"		9/32"	1/2"	368
11349	11	Black	3/4"	19/32"	5/16"	11/16"	400
11350	1	White	1-7/32"		5/16"	1-1/16"	376
11351	1	Black	15/16"		5/16"	11/16"	373
11612	1	Black	7/16"		3/16"	5/8"	366
11671	7	Black	5/8"	1/2"	11/32"	1-1/8"	390
11672	11	White	15/16"	29/32"	5/16"	15/16"	401
11673	1	Natural	15/16"		5/16"	11/16"	373
11675	1	Black	5/8"		5/16"	11/16"	367
11677	13	Natural	9/16"	3/8" x 9/16"	11/32"	11/16"	402
11678	11	White	15/16"	29/32"	5/16"	11/16"	401
11679	1	Black	3/4"		9/32"	1/2"	367
11680	1	Black	7/16"		3/16"	5/8"	366
11721	1	Black	1/2"		9/32"	3/4"	366
11774	12	White	3/4"	11/16"	5/16"	1/2"	401
11796	12	White	7/8"	29/32"	5/16"	3/4"	401
11797	10	White	3/4"	1/2"	11/32"	9/16"	391
11842	1	Black	1-1/4"		5/16"	1-3/16"	376
12137	1	Black	1"		7/16"	13/16"	374
12565	7	Black	25/32"	1/2"	5/16"	5/8"	389
12571	1	Black	1"		5/16"	13/16"	373
12731	1	Black	25/32"		5/16"	15/16"	373
12737	12	White	3/4"	21/32"	5/16"	3/4"	401
12759	1	Black	1"		9/32"	1-7/16"	375
12766	1	Black	7/8"		7/16"	13/16"	374
12909	1	Black	1"		9/32"	1-1/16"	375
12992	14	White	3/4" x 7/8"	9/32" x 19/32"	5/16"	3/4"	402
12993	1	Natural	1/2"		9/32"	11/16"	366
13179	11	Black	17mm	14mm	11mm	14mm	400
13198	1	Black	16mm		9mm	18mm	368
13453	11	White	15/16"	29/32"	5/16"	11/16"	401
13454	1	Black	21/32"		7/32"	15/32"	368
13461	11	White	15/16"	29/32"	5/16"	1-1/8"	401
13467	1	Black	1"		7/16"	1-7/16"	379
13470	7	White	3/4"	1/2"	5/16"	5/8"	389
13475	11	White	19mm	15mm	9mm	18mm	400
13757	Misc.	Black	2" Square		1/4"	9/16"	379
13945	11	White	19mm	15mm	9mm	18mm	400
13946	14	Yellow	3/4" x 7/8"	9/32" x 19/32"	5/16"	3/4"	402
13992	12	White	23/32"	23/32"	5/16"	5/8"	401
14006	1	Black	3/8"		9/32"	1/2"	365

RETAINER SPECIFICATION CHART

Recommended Hole Size: .030"-.060" smaller than stem diameter.

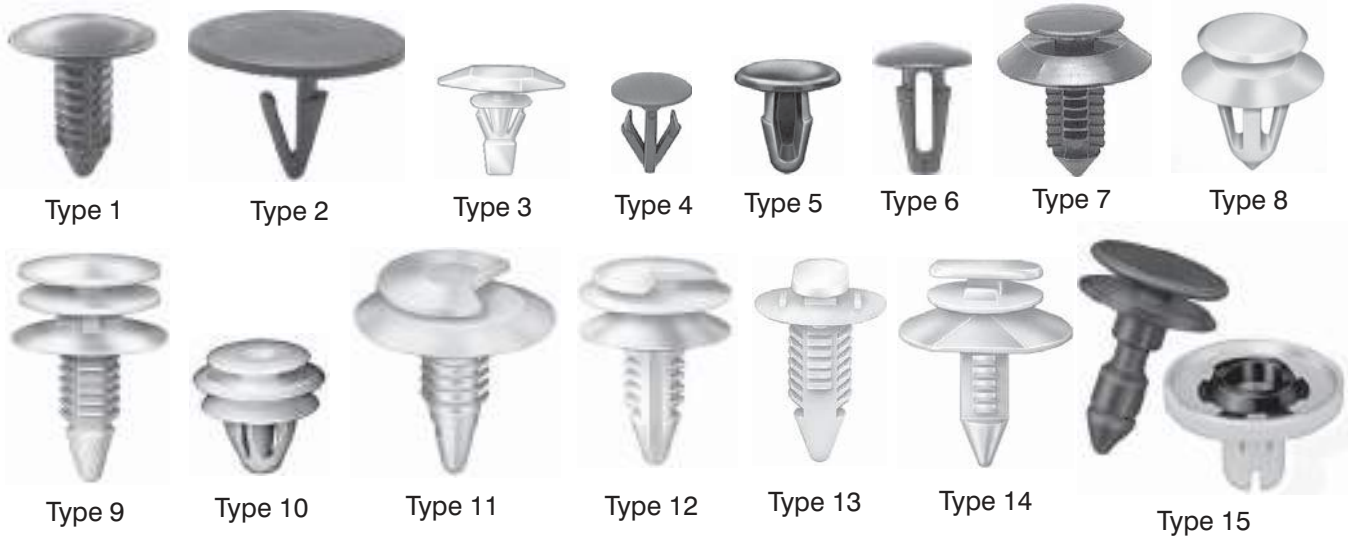

Auveco Part No.	Type	Color	Bottom Head Diameter	Top Head Diameter	Stem Diameter	Stem Length	Page No.
14017	1	Black	1/2"		9/32"	5/8"	366
14021	1	Black	7/16"		7/32"	1/2"	365
14032	1	Black	3/4"		5/16"	1-1/4"	370
14035	1	Natural	19/32"		5/16"	2"	370
14036	1	Black	3/4"		5/16"	1-3/8"	370
14144	10	Black	18mm	13mm	9.5mm	14mm	396
14163	2	Black	1-3/4"		3/8"	3/4"	378
14219	1	Black	1-1/2"		1/4"	1-3/16"	376
14269	10	White	18mm	13mm	9.5mm	14mm	395
14270	10	Blue/Natural	18mm	13mm	9.5mm	14mm	396
14282	6	Black	13mm		7.5mm	15mm	383
14289	1	Black	13mm		5mm	16mm	366
14291	5	Black	11mm		5.5mm	13mm	383
14299	3	White	7mm x 16mm		6.5mm	5mm	379
14319	4	Black	20mm		18mm	20mm	386
14323	4	Black	18mm		10mm	15mm	386
14328	3	White	7mm x 16mm		6mm	10mm	379
14347	4	Black	18mm		9mm	12mm	386
14348	6	Black	16mm		6.5mm	15mm	384
14349	5	Black	11mm		7mm	15mm	383
14352	6	Black	13mm		6mm	13mm	383
14353	4	Black	14mm		10mm	16mm	386
14355	6	Black	11mm		6mm	13mm	382
14356	4	Black	20mm		11mm	16mm	386
14363	11	White	17mm	15mm	10mm	14mm	400
14367	1	Black	12mm		5mm	12mm	365
14380	4	Black	18mm		12mm	18mm	386
14524	12	White	3/4"	21/32"	5/16"	3/4"	401
14709	1	Black	20mm		5.5mm	9mm	367
14720	4	Black	18mm		12.5mm	15mm	386
14723	4	Black	14mm		9mm	11mm	385
14728	10	Natural/Yellow	16mm	12.5mm	8.5mm	11mm	395
14736	5	Black	14mm		6mm	10mm	383
14737	6	Black	13mm		7mm	15mm	383
14738	6	Black	30mm		8mm	17mm	385
14757	1	Black	1/2"		1/4"	15/16"	368
14758	13	White	7/8" x 7/8"	3/8" x 7/8"	5/16"	19/32"	402
14857	1	Black	1/2"		9/32"	5/8"	366
14921	1	Black	10mm		6mm	12mm	365
14985	3	White	3/16" x 9/16"		1/8" x 3/8"	5/16"	379
15040	1	Black	3/4"		7/32"	11/16"	369
15050	1	Black	15mm		5.5mm	19mm	367
15367	1	Black	19/32"		7/32"	3/4"	367
15414	1	Black	11/16"		5/16"	13/16"	371
15456	1	Black	1-21/32"		5/16"	3/4"	377
15457	1	Black	1-3/8"		5/16"	15/16"	377
15461	11	White	3/4"	5/8"	5/16"	1"	401
15478	1	Black	22mm		11mm	28mm	374
15479	1	Black	26mm		8mm	38mm	375
15480	1	Black	25mm		8mm	20mm	373
15481	1	Black	25mm		7.5mm	20mm	373
15523	1	Black	1"		1/4" x 5/16"	1-1/8"	373
15543	1	Black	7/8"		5/16"	1-3/32"	372
15664	1	White	11/16"		5/16"	5/8"	371
15668	1	Black	1-3/4"		9/32"	1"	377
15669	11	White	15/16"	29/32"	5/16"	1-1/4"	401
15670	14	White	1/2"	1/4" x 29/64"	5/16"	3/4"	402

Sec. 19

RETAINER SPECIFICATION CHART

Recommended Hole Size: .030"-.060" smaller than stem diameter.

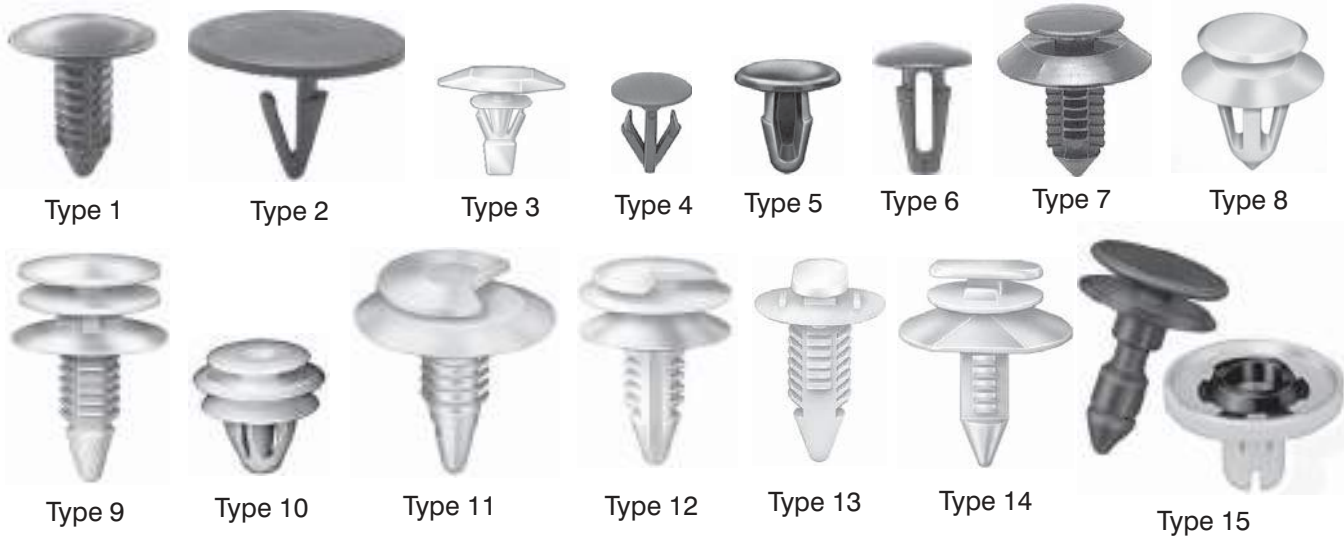

Auveco Part No.	Type	Color	Bottom Head Diameter	Top Head Diameter	Stem Diameter	Stem Length	Page No.
15707	10	Gray	17.5mm	13mm	10mm	14mm	396
15709	7	Natural	17.5mm	13mm	9.5mm	13mm	396
15970	14	White	9/16" x 11/16"	9/32" x 1/2"	5/16"	3/4"	402
15998	1	Black	30mm		6.5mm	9mm	376
16017	11	White	3/4"	5/8"	5/16"	1"	401
16132	1	Black	19mm		9mm	20mm	372
16259	1	Black	11/16"		5/16"	5/8"	371
16260	12	White	3/4"	11/16"	5/16"	1/2"	401
16261	12	White	7/8"	29/32"	5/16"	3/4"	401
16262	1	Black	7/8"		7/16"	13/16"	374
16263	1	Black	1"		7/16"	13/16"	374
16695	9	White	20mm	18mm	8mm	23mm	292
16775	1	Black	20mm		4.5mm	15mm	371
16776	1	Black	18mm		7.5mm	20mm	369
16777	4	Black	15mm		12mm	15mm	385
16778	11	Natural	18.5mm	14mm	11.5mm	14mm	400
16779	4	Black	18mm		11mm	15mm	386
16781	6	Black	15mm		8.5mm	20mm	384
16818	1	Black	3/4"		11/32"	7/8"	369
16863	1	Black	1-3/4"		5/16"	29/32"	377
16938	9	Black	8mm	14mm	8mm	15mm	391
17004	2	Black	1-5/16"		3/8"	3/4"	378
17072	Misc.	Black	1-1/2"		1-1/4"	5/16"	379
17075	9	White	3/4"	33/64"	5/16"	13/16"	391
17076	1	Black	18mm		7mm	23mm	372
17092	14	Yellow	13/16" x 29/32"	5/8"	5/16"	3/4"	402
17102	7	White	3/4"	1/2"	5/16"	1"	390
17124	7	Black	3/4"	1/2"	11/32"	3/4"	389
17205	4	Black	14mm		8mm	15mm	385
17215	1	Black	40mm		8mm	13mm	377
17218	7	Natural	20mm	13mm	8mm	18mm	389
17237	Misc.	Black	38mm		7mm	9mm	378
17339	3	Black	5mm x 15mm		4mm	12mm	381
17381	1	Gray	32mm		8mm	20mm	376
17452	5	Black	13mm		5mm	15mm	383
17453	1	Gray	15mm		6.5mm	14mm	367
17599	Misc.	Black	3/4"		9/32" x 11/32"	11/16"	403
17612	1	Black	5/8"		3/8"	3/4"	371
17634	1	Black	12mm		6mm	16mm	366
17649	13	White	1/2" x 5/8"	9/32" x 1/2"	5/16"	7/8"	402
17664	1	Black	11/16"		5/16"	1-1/16"	371
17669	10	Yellow	23/32"	1/2"	5/16"	9/16"	397
17685	10	Yellow	18mm	13mm	8mm	25mm	399
17975	2	Black	1-3/16"		5/16"	1/2"	378
17990	6	Black	14mm x 15mm		7mm	19mm	384
17991	3	Black	8mm x 17mm		8mm	14mm	382
18033	3	White	1/4" x 21/32"		1/4"	15/32"	381
18114	4	Black	10mm		7.5mm	10mm	385
18157	6	Gray	13mm		5mm	16mm	383
18166	Misc.	Black	10mm		4mm	10mm	382
18174	1	Black	3/4"		5/16"	13/16"	369
18175	7	Natural	15/16"	1/2"	5/16"	5/16"	390
18248	2	Black	7/16"		11/64"	3/8"	382
18271	5	Black	14mm		6mm	15mm	384
18275	1	Blue	1"		5/16"	1-1/2"	375
18277	1	Gray	1"		5/16"	1-1/2"	375
18294	10	White	18mm	13mm	10.5mm	14mm	398

RETAINER SPECIFICATION CHART

Recommended Hole Size: .030"-.060" smaller than stem diameter.

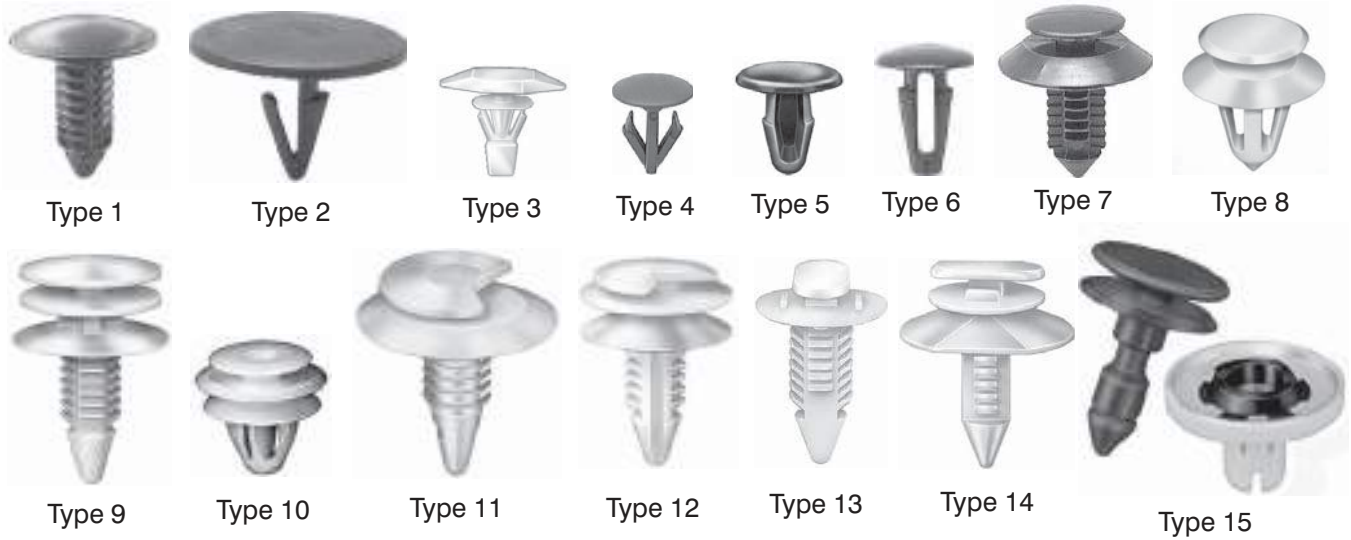

Auveco Part No.	Type	Color	Bottom Head Diameter	Top Head Diameter	Stem Diameter	Stem Length	Page No.
18297	6	Black	13mm		7.5mm	11mm	383
18298	1	Black	1/2"		5/16"	11/16"	366
18301	1	Black	3/4"		11/32"	1-3/16"	370
18302	1	Black	7/16"		7/32"	15/32"	365
18330	3	White	3/16" x 37/64"		11/64"	9/16"	382
18371	1	Gray	3/4"		5/16"	1-1/4"	370
18379	1	Black	23/32"		5/16"	7/8"	369
18389	1	Black	1/2"		9/32"	7/16"	365
18391	7	Natural	3/4"	1/2"	5/16"	1-5/32"	390
18458	4	Black	14mm		6mm	10mm	385
18508	3	Black	3/16" x 19/32"		15/32"	5/16"	382
18509	3	Natural	9/32" x 35/64"		9/32"	1/2"	379
18510	3	Natural	3/16" x 1/2"		13/64"	13/32"	379
18679	1	Gray	1"		7/16"	13/16"	374
18680	1	Black	1-1/32"		9/32"	1-3/32"	374
18682	1	Black	1/2"		1/4"	3/4"	366
18683	1	Black	23/64"		3/16"	7/16"	365
18684	1	Black	3/8"		5/32"	3/8"	365
18685	1	Black	31/32"		9/32"	3/4"	372
18688	1	Gray	1-1/32"		9/32"	1-3/32"	374
18692	3	Natural	5mm x 15mm		5mm Hole	10mm	381
18746	Misc.	Black	30mm		15mm x 18mm	10mm	378
18770	1	Black	3/8"		7/32"	5/8"	365
18771	1	Black	1"		19/64"	1-1/16"	374
18815	1	Black	9/16"		5/16"	3/4"	367
18818	6	Natural	7mm x 16mm		5mm	12mm	382
18820	1	Black	3/4"		7/32"	1/2"	368
18824	10	White	15mm	13mm	9mm	9.5mm	392
18827	2	Black	25/32"		5/16"	7/16"	377
18842	6	Black	30mm		8.5mm	17mm	385
18844	10	White	18mm	13mm	10mm	13mm	395
18848	7	Yellow	3/4"	1/2"	3/8"	11/16"	389
18859	1	Black	19/32"		5/16"	1-3/8"	370
18861	8	White	18mm	13mm	8.5mm x 8.5mm	12mm	387
18862	10	Green	23/32"	19/32"	5/16"	5/8"	398
18874	10	Gray	18mm	13mm	9.5mm	15mm	397
18875	8	White	19mm	13mm	11mm	15mm	388
18876	10	White	18mm	13mm	9mm x 9mm	14mm	396
18877	3	Orange	5mm x 15mm		6mm	10mm	381
18878	6	Black	30mm		6mm	16mm	384
18897	1	Black	13/32"		13/64"	7/8"	366
18915	10	White	23/32"	1/2"	5/16"	9/16"	397
18930	10	Yellow	18mm	13mm	9mm	18mm	399
18936	14	White	19/32"	39/64" x 7/16"	5/16"	1/2"	402
18948	1	Black	7/16"		7/32"	11/16"	366
18950	10	Black/White	18mm	13mm	10mm	13mm	395
19014	Misc.	Natural	11mm x 12mm		9.5mm	16mm	383
19016	10	Dark Gray	18mm	13mm	9.5mm	15mm	397
19108	10	Natural	18mm	13mm	9.5mm	14mm	397
19109	10	Natural	15mm	13mm	9.5mm	11mm	393
19112	6	Black	30mm		8mm	16mm	385
19113	6	Black	25mm		8mm	12mm	384
19114	4	Black	12mm		8.5mm	9mm	385
19116	3	Natural	5mm x 15mm		6mm	10mm	381

Sec. 19

RETAINER SPECIFICATION CHART

Recommended Hole Size: .030"-.060" smaller than stem diameter.

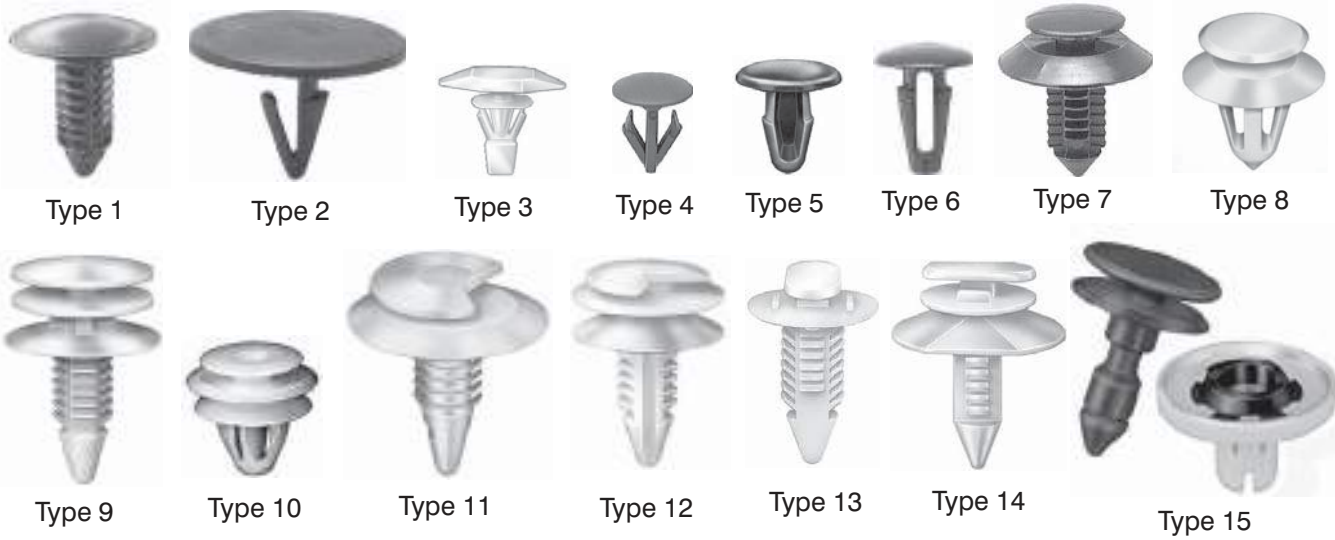

Auveco Part No.	Type	Color	Bottom Head Diameter	Top Head Diameter	Stem Diameter	Stem Length	Page No.
19121	1	Gray	20mm		8mm	20mm	371
19122	6	Natural	15mm		8mm	12mm	384
19123	Misc	Black	17mm		7mm	12mm	384
19124	4	Black	16mm		10mm	10mm	386
19127	1	Black	1"		1/4"	25/32"	372
19129	10	Yellow	18mm	13mm	9.5mm	17mm	398
19145	10	Gray	17mm	13mm	9mm	12mm	394
19149	1	Black	3/8"		7/32"	5/8"	366
19155	2	Black	1-9/32"		3/8"	3/4"	378
19171	3	Green	5mm x 15mm		5mm Hole	10mm	381
19197	1	Gray	25mm		8mm	20mm	373
19203	10	Natural	18mm	13mm	11mm	11mm	394
19210	10	Natural	18mm	13mm	10mm	14mm	397
19213	7	Natural	3/4"	1/2"	11/32"	3/4"	389
19250	1	White	11/16"		5/16"	13/16"	371
19257	9	Maroon	18mm	13mm	9.5mm	14mm	397
19270	9	White	20mm	18mm	8mm	24mm	392
19275	9	White	20mm	18mm	8mm	13mm	391
19312	1	Black	16mm		5mm	13mm	367
19320	8	White	16mm	12mm	9mm	11mm	387
19323	6	Black	26mm		10mm	8mm	384
19325	3	Brown	5mm x 13mm		7mm	6mm	380
19331	6	Black	14mm		7mm	11mm	383
19334	8	Natural	16mm	12mm	9mm	15mm	388
19338	1	Black	1-1/4"		5/16"	11/16"	376
19352	1	Gray	3/4"		5/16"	1-7/16"	370
19354	1	Tan	3/4"		5/16"	1-7/16"	370
19356	9	White	20mm	18mm	8mm	20mm	391
19368	3	Natural	5mm x 15mm		5mm Hole	9mm	381
19371	1	Blue	19/32"		9/32"	27/32"	371
19372	1	Dark Gray	19/32"		9/32"	27/32"	371
19373	1	Light Gray	19/32"		9/32"	27/32"	371
19374	1	Tan	19/32"		9/32"	27/32"	371
19385	6	Gray	26mm		10mm	8mm	384
19386	10	Natural	20mm	15mm	9mm	15mm	397
19398	14	Natural	17mm	4mm x 9mm	8mm	18mm	402
19418	1	Black	13/32" x 1"		9/32"	9/16"	380
19425	3	Natural	9/32" x 1/2"		7/32"	21/32"	380
19428	Misc	White	20mm	18mm	8mm	19mm	399
19449	1	Black	13/64" x 7/8"		7/32"	5/8"	380
19464	7	Natural	16mm	13mm	7mm	13mm	388
19466	10	White	17mm	13mm	9.5mm	12mm	393
19467	6	Black	13mm		6mm	10mm	383
19468	1	Black	28mm		6mm	10mm	376
19470	1	Black	16mm		4mm	21mm	368
19481	3	Blue	5mm x 15mm		6mm Hole	8mm	380
19483	3	Black	8mm x 18mm		7mm	15mm	382
19501	1	Tan	1-1/32"		9/32"	1-1/32"	374
19506	1	Black	16mm		5mm	13mm	367
19524	Misc	Green	15mm		8mm	13mm	403
19527	10	Yellow	20mm	18mm	8mm	13mm	391
19532	Misc	Black	5/8"		5/16"	5/32"	379
19541	1	Black	1"		9/32"	5/8"	373
19628	10	White	18mm	15mm	8.5mm	14mm	398
19643	1	Black	16mm		6mm	16mm	368
19655	2	Black	1-3/16"		3/8"	3/4"	378

RETAINER SPECIFICATION CHART

Recommended Hole Size: .030"-.060" smaller than stem diameter.

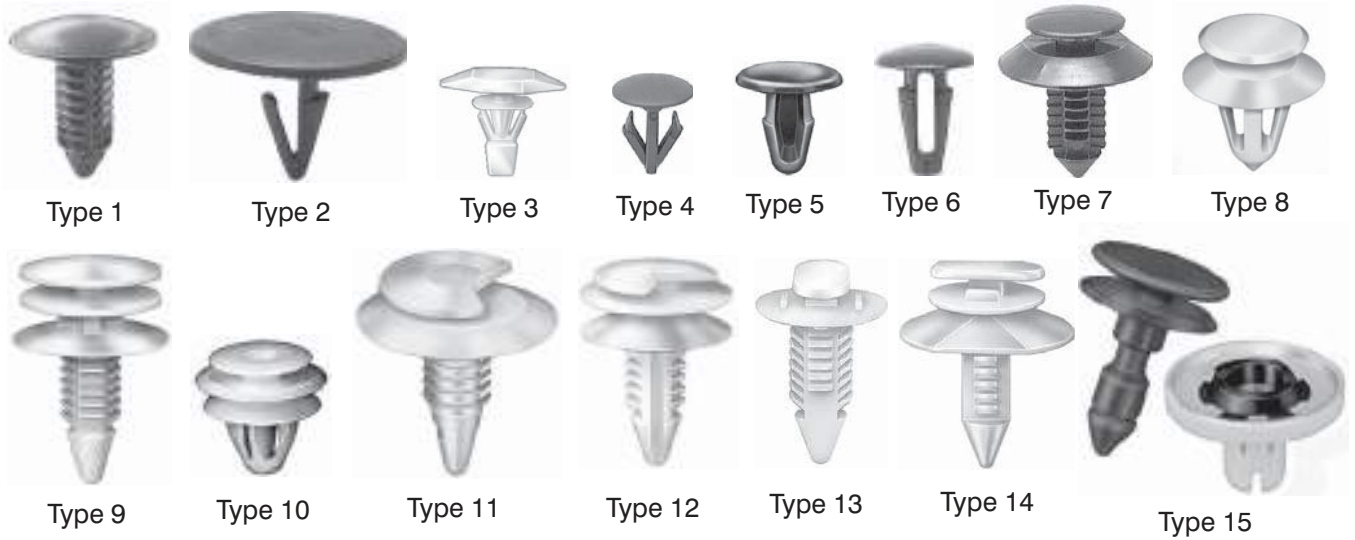

Auveco Part No.	Type	Color	Bottom Head Diameter	Top Head Diameter	Stem Diameter	Stem Length	Page No.
19667	1	Black	3/4"		7/32"	11/16"	368
19673	1	Black	10mm x 15mm		5mm	10mm	366
19678	3	White	5mm x 15mm		6mm	10mm	379
19682	4	Black	11mm		7mm	8mm	385
19683	3	Black	6mm x 16mm		7mm	14mm	381
19684	3	Blue	7mm x 16mm		6mm Hole	12mm	381
19686	1	Black	12mm		5mm Sq.	6mm	365
19719	8	White	18mm	13mm	10mm	11mm	387
19720	3	Black/White	8mm x 17mm		7mm Hole	16mm	382
19724	3	White	6mm x 16mm			15mm	382
19728	3	Black	8mm x 17mm		7mm Hole	14mm	382
19729	4	Black	25mm		9mm	10mm	384
19731	10	White	17mm	13mm	9.5mm	13mm	394
19744	1	Black	16mm		6mm	27mm	368
19746	Misc.	White	10.5mm		3.5mm, 5mm	15mm	365
19749	3	White	5mm x 15mm		6mm Hole	10mm	381
19758	Misc.	Green	19mm	19mm	8mm	20mm	400
19759	Misc.	White	19mm	19mm	8mm	23mm	400
19760	1	Black	25mm		8mm	24mm	372
19774	1	Black	13/32"		5/16"	1-5/16"	369
19775	Misc.	White	18mm	13mm	8mm	18mm	399
19790	1	Gray	11/16"		5/16"	13/16"	371
19802	10	White	16mm	12mm	8mm	24mm	389
19804	Misc.	White	22mm	16mm	9mm	15mm	400
19810	7	Black	13mm	12mm	8mm	19mm	389
19834	1	Black	3/4"		5/16"	1-1/16"	372
19836	1	Black	7/16"		7/32"	11/16"	366
19837	1	Black	3/4"		11/32"	13/16"	372
19842	Misc.	Black	18mm		11mm	22mm	369
19845	1	Med. Graphite	1"		5/16"	1-3/4"	375
19846	1	Black	1"		5/16"	1-3/4"	375
19850	3	Natural	5mm x 15mm		5mm	8mm	380
19855	1	Black	23/32"		15/64" x 9/32"	3/4"	370
19893	1	Black	5/8"		1/4"	3/4"	368
19898	10	Yellow	18mm	13mm	9.5mm	13mm	396
19910	10	Yellow	18mm	13mm	9mm x 9mm	14mm	396
20164	2	Black	30mm		8mm	12mm	378
20165	1	Black	10mm		6mm	12mm	365
20167	1	Black	22mm		6mm Sq.	16mm	372
20177	1	Gray	11/16"		5/16"	1-3/8"	370
20180	3	Black	6.5mm x 11mm		5.5mm	12mm	379
20181	3	White	6.5mm x 16mm		6mm	8mm	381
20182	3	White	6.5mm x 16mm		6mm	6mm	379
20184	1	Black	16mm		8mm	16mm	368
20188	11	White	18mm	13mm	8.5mm	11mm	400
20189	1	Black	1"		5/16"	5/8"	372
20190	Misc.	Carmel/White	20mm	13mm	8.5mm	16mm	398
20192	1	Black	11/16"		5/16"	1-3/4"	370
20252	11	Black	18mm	14mm	9mm	14mm	400
20253	12	White	18mm	14mm	9mm	15mm	401
20256	1	Black	15mm		4.5mm	14mm	366
20262	1	Black	1"		7/16"	9/16"	374
20274	7	White	23mm	13mm	6.5mm	20mm	389
20279	Misc.	White	13/16" x 1-7/16"	5/16" x 3/4"	5/16"	7/8"	402
20281	1	Black	21mm		13mm	27mm	373
20311	1	Black	14mm		7mm	9mm	366

Sec. 19

RETAINER SPECIFICATION CHART

Recommended Hole Size: .030"-.060" smaller than stem diameter.

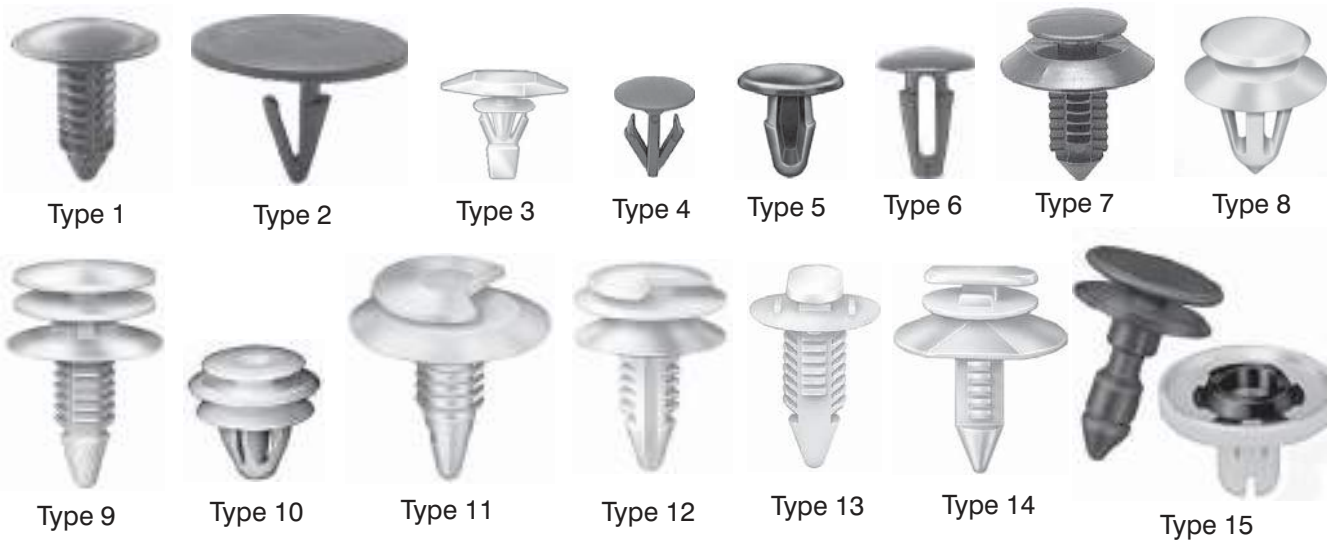

Auveco Part No.	Type	Color	Bottom Head Diameter	Top Head Diameter	Stem Diameter	Stem Length	Page No.
20316	1	Black	1"		5/16"	13/16"	374
20319	1	Black	25mm		9mm	12mm	372
20334	1	Black	18mm		7.5mm	20mm	369
20338	9	White	25/32"	11/16"	5/16"	1-1/4"	392
20341	Misc.	Black	22mm		10.5mm	10mm	402
20344	1	Black	7/16"		7/32"	5/16"	365
20345	1	Gray	1"		1/4" x 5/16"	1-1/8"	375
20360	1	Black	15/16"		3/8"	3/4"	372
20362	1	Black	25mm		13mm	15mm	374
20366	1	Black	22mm		7.5mm	35mm	370
20381	6	Black	16mm		7mm	16mm	384
20399	1	Black	3/4"		7/32"	15/32"	367
20411	10	Black	14.5mm	13mm	9.5mm	12mm	394
20427	10	Gray/White	20mm	15mm	9mm	18mm	399
20428	10	Green/White	20mm	15mm	9mm	18mm	398
20437	10	White	18mm	13mm	8.5mm x 8.5mm	15mm	395
20443	3	Black	5mm x 15mm		7mm	10mm	381
20444	10	White	19mm	20mm	11mm	17mm	398
20459	10	Black	16mm	15mm	9mm	10mm	392
20460	8	Black	18mm	14mm	9mm	13mm	387
20473	8	White	18mm	13mm	11mm	14mm	388
20515	10	Yellow/White	20mm	15mm	9mm	14mm	397
20528	1	Black	9mm		6mm	14mm	365
20531	1	Black	21mm		7.5mm	25mm	369
20541	1	Tan	35mm		7.5mm	20mm	377
20543	4	Black	26mm		12mm	14mm	386
20558	10	White	15mm	13mm	8.5mm x 9.5mm	11mm	392
20559	10	Blue	18mm	13mm	9mm x 9mm	11mm	393
20563	10	White	22mm	16mm	9mm	15mm	399
20571	8	White	18mm	13mm	9mm	9mm	387
20575	10	Yellow/White	18mm	13mm	10mm	13mm	394
20576	8	Yellow	14mm x 18mm	10mm x 13mm	8.5mm x 8.5mm	9mm	387
20609	1	Black	30mm		15mm x 20mm	14mm	378
20610	10	White	16mm	13mm	9mm	15mm	397
20611	8	Blue	16mm	12mm	3mm	7mm	387
20615	1	Black	35mm		8mm	20mm	376
20616	10	White	18.5mm	19.5mm	11mm	17mm	399
20624	1	Black	18mm		7.5mm	33mm	369
20625	1	Tan	25mm		8mm	29mm	375
20633	10	Turquoise	18mm	13mm	8.5mm x 9mm	14mm	395
20634	7	White	16mm	13mm	7mm	26mm	390
20642	8	Gray	16mm	13mm	9mm	13mm	387
20643	Misc.	Black	13mm		6.5mm	11mm	383
20668	10	White	18mm	13mm	9mm	14mm	395
20669	10	Black	18mm	13mm	9mm	15mm	396
20670	10	Gray	18mm	13mm	8.5mm	12mm	392
20671	5	Black	20mm		9.5mm	15mm	384
20672	7	White	16mm	13mm	4mm	13mm	388
20735	11	Black	18mm	11.5mm	9mm	14mm	400
20760	3	Natural	5mm x 15mm		8mm	7mm	380
20761	1	Black	18mm		8.5mm	32mm	370
20762	Misc.	Black	1/2"		19/64"	19/32"	403
20765	10	Yellow	18mm	15mm	10mm	15mm	398
20770	4	Yellow	10mm		9mm	14.5mm	385

RETAINER SPECIFICATION CHART

Recommended Hole Size: .030"-.060" smaller than stem diameter.

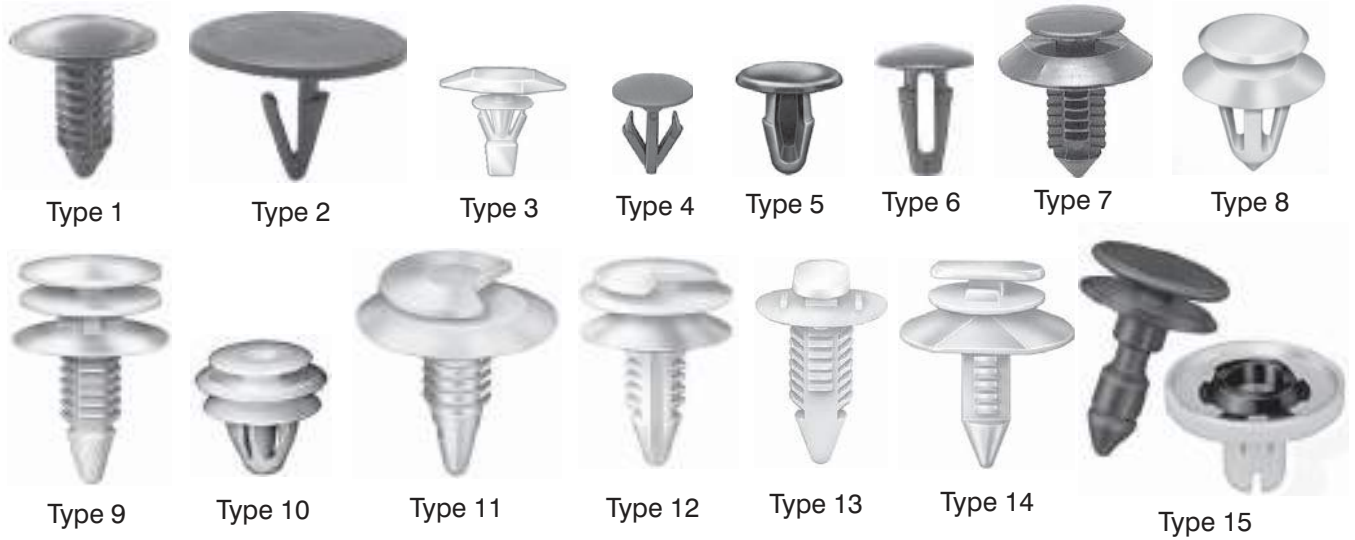

Auveco Part No.	Type	Color	Bottom Head Diameter	Top Head Diameter	Stem Diameter	Stem Length	Page No.
20814	9	White	25/32"	11/16"	5/16"	13/16"	392
20829	7	Black	18mm	14mm	8mm	15mm	389
20831	3	Blue	5mm x 14mm		6.5mm	10mm	381
20866	Misc.	White	1/2"		11/32"	7/16" & 7/8"	403
20874	1	Black	25mm		7mm	23mm	375
20878	1	Black	19mm		7.5mm	16mm	371
20879	10	Green	17mm	13mm	9mm	14mm	394
20881	8	White	16mm	13mm	8mm	13mm	387
20882	6	Black	20mm		7mm	15mm	384
20893	1	Black	12.5mm		7.5mm	15mm	366
20926	1	Black	18mm		7.5mm	44mm	370
20932	8	White	18mm	14mm	12mm	14mm	388
20944	7	Green	25mm	18mm	8mm	24mm	390
20946	10	Black	20mm	14mm	9.5mm	16mm	399
20949	10	Black & Blue	16mm	13mm	8mm	12mm	398
20959	10	Blue	15mm	13mm	9.5mm	13mm	394
20983	10	White	18mm	13mm	9mm	13mm	393
20995	15	White	19.5mm	19mm		22mm	390
20996	15	Yellow	19.5mm	19mm		22mm	390
20998	15	Black & White	19.5mm	19mm		22mm	391
20999	15	Green & Yellow	19.5mm	19mm		22mm	391
21012	8	Black	18mm	13mm	9.5mm	14mm	388
21023	Misc.	Black	9/16"		19/64"	13/32"	403
21026	1	Black	20mm		8.5mm	20mm	371
21059	10	Blue	18mm	12mm x 13mm	8.5mm x 8.5mm	14mm	397
21070	10	Yellow	16mm	13mm	9.5mm	10mm	393
21087	10	Orange	18mm	12mm	9.7mm	14mm	396
21088	8	White	17mm	13mm	9.5mm	14mm	388
21090	1	Black	1"		11/32"	3/4"	373
21091	8	Black	25mm	13mm	10.5mm	14mm	389
21102	10	White	18mm	13mm	8.5mm	14mm	395
21105	4	Black	20mm		14mm	10mm	386
21107	7	White	16mm	13mm	4mm	13mm	388
21118	10	White	18mm	13mm	10mm	14mm	396
21125	1	Black	20mm x 36mm		17mm	25mm	380
21131	10	Black	18mm	12mm	9.5mm	13mm	398
21137	10	Black	15mm	13mm	10mm	8mm	392
21138	10	White	18mm	14mm	9mm	14mm	395
21139	10	White	18mm	12mm	9.5mm	11mm	393
21143	1	Black	8.5mm x 14mm		5mm x 7.5mm	14mm	380
21144	Misc.	Black	27mm	21.5mm	11mm	19mm	403
21149	10	White	15mm	13mm	9.5mm	11mm	393
21169	10	White	22mm	16mm	11mm	17mm	399
21188	10	Pink	18mm	15mm	10mm	12mm	392
21189	10	Black	19mm	20mm	11mm	16mm	399
21199	1	Black	18mm		7.5mm	20mm	367
21206	10	Orange	18mm	13mm	8.5mm	14mm	394
21208	10	Gray	18mm	13mm	9mm	12mm	393
21211	4	Black	24mm		9mm	12mm	378
21227	1	Tan	45mm		9.5mm	20mm	377

Sec. 19

RETAINER SPECIFICATION CHART

Recommended Hole Size: .030"-.060" smaller than stem diameter.

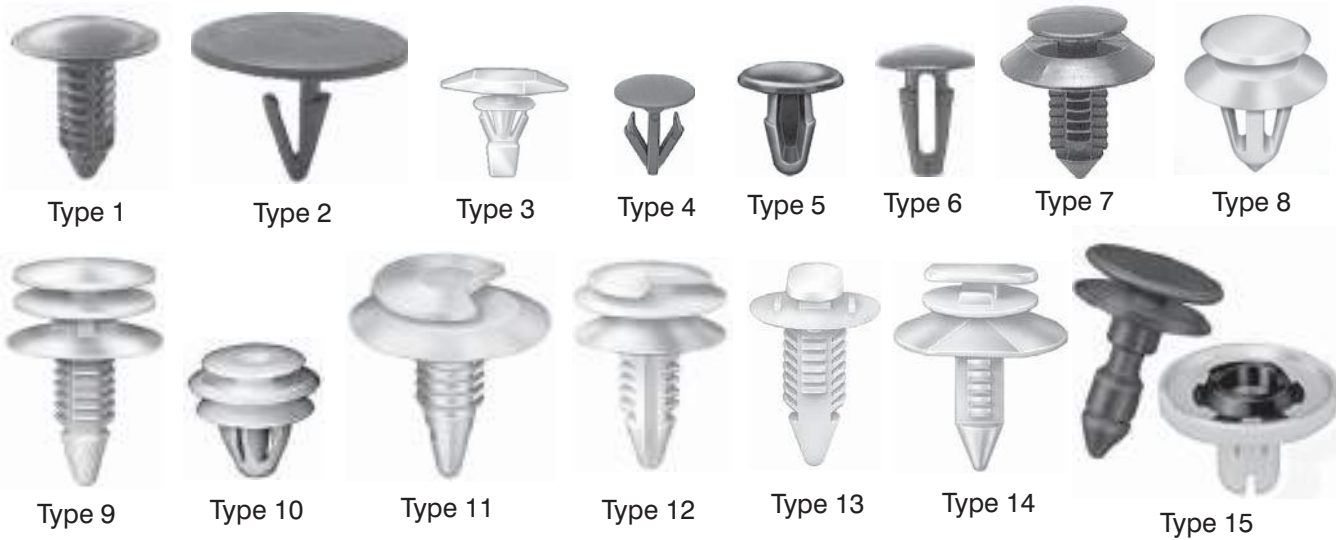

Auveco Part No.	Type	Color	Bottom Head Diameter	Top Head Diameter	Stem Diameter	Stem Length	Page No.
21228	.1	Tan	25mm		8.5mm	37mm	375
21229	.6	Black	6.4mm x 16mm		3.5mm x 6mm	10mm	381
21240	.10	Green	18mm	14mm	9mm	10mm	393
21241	.1	Black	26mm		7.5mm	28mm	375
21247	.10	Green	18mm	15mm	12mm	14mm	397
21248	.1	Tan	25mm		7.5mm	22mm	372
21250	.10	Black	16mm	13mm	11mm	14mm	398
21252	.8	White	15mm	13mm	9mm	11mm	387
21253	.1	Gray	20mm		6mm	15mm	368
21254	.1	Black	20mm		8mm	8mm	386
21257	.1	Black	23mm		8mm	20mm	372
21287	.1	Opal Gray	25mm		8mm	58mm	375
21288	.1	Black	28mm		6mm	10mm	376
21289	.10	Yellow	18mm	12.5mm	9.5mm	14mm	395
21295	.6	Black	10mm		6mm	8mm	382
21296	.6	Black	13mm		7mm	10mm	383
21301	.1	Black	25mm		5.8mm	25.5mm	372
21303	.1	Black	18mm		7mm x 7mm	13mm	367
21307	.4	Black	9mm		5.5mm	7mm	385
21313	.1	Black	31mm		7.6mm	13mm	376
21329	.10	Black	18mm	15mm	9mm	13mm	395
21332	.1	Tan	20mm		6mm	15mm	368
21333	.10	Blue	18mm	13mm	10mm	14mm	398
21334	.3	White	5mm x 15mm		8mm	8mm	380
21338	.1	Black	25.4mm		8mm	27mm	373
21346	.7	White	12mm x 16mm	15mm	5mm	34mm	390
21349	.1	Gray	18mm		8mm	16mm	367
21350	.1	Tan	18mm		8mm	16mm	367
21360	.10	White	16mm	13mm	10mm	12mm	394
21364	.8	Green	17mm	15mm	9mm	14mm	388
21365	.8	Blue	17mm	13mm	9mm	13mm	387
21379	.10	Black	18.5mm	19.5mm	11mm	16mm	399
21380	.1	Black	28mm		8mm	17mm	376
21381	.1	Black	5mm x 13mm		8mm	11mm	380
21382	.1	Black	6mm x 16mm		8mm	14mm	379
21383	.7	White	19mm	19mm	7mm	22mm	390
21385	.1	Light Gray	33mm		8mm	41mm	377
21386	.1	Tan	33mm		8mm	41mm	377
21392	.1	Black	23mm		6.5mm	16mm	372
21393	Misc.	Green & Black	19mm	28mm	9mm	9mm	403
21398	Misc.	Black	18mm	22mm	9mm	11mm	403
21410	.10	White	18mm	13mm x 18mm	10.7mm	12mm	392
21412	.8	Gray	18.5mm	14mm	12mm	13mm	389
21414	.10	White	18mm	13mm	9mm	13mm	394
21415	Misc.	Tan & White	28.5mm		9.5mm	11mm	403
21421	.1	Black	30mm		7.7mm	13mm	376
21443	.1	Black	30mm		7.8mm	15mm	376
21450	.8	Black	18mm	13.5mm	9mm	14mm	388
21458	.1	Black	10mm		5.5mm	7mm	365
21488	.8	Gray	17mm	13mm	9mm	14mm	387
21489	.8	Yellow	17mm	15mm	9mm	14mm	388
21494	.11	Natural	18mm	12mm	9.5mm	12mm	400
21495	.8	Blue	18mm	13mm	9mm	14mm	387
21496	.8	White	18mm	12mm	10mm	12mm	387

RETAINER SPECIFICATION CHART

Recommended Hole Size: .030"-.060" smaller than stem diameter.



Type 1 Type 2 Type 3 Type 4 Type 5 Type 6 Type 7 Type 8



Type 9 Type 10 Type 11 Type 12 Type 13 Type 14 Type 15

Auveco Part No.	Type	Color	Bottom Head Diameter	Top Head Diameter	Stem Diameter	Stem Length	Page No.
21497	Misc.	Black	6mm x 15mm		7.5mm	17mm	385
21502	10	White	15mm	13mm	9.5mm	14mm	396
21509	Misc.	White	18mm	12mm	10mm	16mm	387
21516	7	White	18mm	12mm	10mm	20mm	390
21519	1	Black	12mm		6mm	15mm	366
21520	4	Black	14mm		6.5mm	10mm	385
21532	7	White	12mm	13mm	8mm	25mm	390
21535	15	White	19.5mm	19.5mm		26mm	391
Grommet Flange: 24mm; Grommet Stem Length: 12mm; Fits Into 9mm Hole							
21536	15	Yellow	19.5mm	19.5mm		26mm	391
Grommet Flange: 24mm; Grommet Stem Length: 12mm; Fits Into 9mm Hole							
21548	1	Black	10mm		6mm	10mm	395
21551	Misc.	Black	12mm	9mm	7mm	13mm	386
21552	3	White	9mm	5mm x 15mm	6.5mm	4mm	380
21554	10	Black	15mm	13mm	9.5mm	11mm	394
21560	1	Black	20mm		7mm	15mm	368
21565	3	White	5mm x 14mm		7mm	8.5mm	380
21567	8	Gray	18mm	11mm x 15mm	9.7mm	12mm	388
21573	5	Black	9mm		6.5mm	13mm	382
21574	10	White	15mm	13mm	9.5mm	11mm	393
21584	10	White	18mm	13mm	9.3mm	10mm	392
21588	4	Black	8mm		5.3mm	7mm	385
21589	1	Black	18mm		7.7mm	15mm	367
21591	8	Black	17mm	11mm x 14mm	9.7mm	12mm	388
21626	6	Black	12mm		6.5mm	11mm	383
21627	1	Black	9mm		5.3mm	8mm	365
21630	1	Black	20mm		6mm	22mm	368
21633	3	White	6mm x 16mm		6.5mm	12mm	381
21634	Misc.	Black	16.5mm		9mm	13mm	384
21638	10	White	15mm	13mm	9.5mm	11mm	393
21640	10	Black	18mm	13mm	9mm	14mm	396
21643	6	Black	7mm x 13mm		7.5mm	13mm	383
21652	Misc.	Black	30mm		15mm x 21mm	14mm	378
21654	10	White	18mm	13mm	9.5mm	14mm	395
21661	1	Black	20mm		7mm	10mm	367
21673	1	Black	20mm		9mm	17mm	368
21675	10	Green	18mm	13mm	9.5mm	11mm	393
21676	10	Yellow	18mm	13mm	9.5mm	12mm	394

Listed smallest to largest first by Head Diameter then by Stem Length and then by Hole Diameter



17227
(21077405)
Black Nylon

Door Handle To Door
Hardware Attachment
Push-Type Retainer
Head Diameter: 7mm
Stem Length: 10mm
Fits Into 5mm Hole
2 Door & 4 Door Models
GM Saturn
1991-On

UNIT PACKAGE: 25



19854
(21097229)

Door Handle
Push-Type Retainer
Head Diameter: 7mm
Stem Length: 10mm
Fits Into 5mm Hole
Saturn 2 Door & 4 Door
1999 - On

UNIT PACKAGE: 25



21585
(90913-0003)
Black Nylon

Upper Grille Push-Type Retainer
Head Diameter: 9mm
Stem Diameter: 7mm
Fits Into 4mm Hole
Subaru Baja, Legacy, & Outback
2006 - 2000

UNIT PACKAGE: 25



14016
(GM: 16500308; Chry: 6500787)
Black Nylon

Tail Light Retainer
Large Head Diameter: 3/8" (9.5mm)
Stem Length: 7/16" (11)mm
Fits Into 3/16" (4.8mm) Hole
GM & Chrysler

UNIT PACKAGE: 25



13999
(20363491)
Black Nylon

Body Side Moulding
Push-Type Retainer
Large Head Diameter: 3/8" (9.5mm)
Stem Length: 1/2" (12.7mm)
Fits Into 7/32" (5.6mm) Hole
GM 1979 - On

UNIT PACKAGE: 25



13230
(Mercedes:
000-990-03-92;
Volvo: 947-098)
Black Nylon

Push-Type Retainer
Head Diameter: 10mm
Stem Diameter: 7mm
Fit Into 5mm Hole

UNIT PACKAGE: 50

**Refer To Push-Type
Retainer Specification
Chart On Pages 450 - 460**



21663
(EA01-50-037)
Black Nylon

Push-Type Retainer
Head Diameter: 10mm
Stem Length: 9mm
Fits Into 5mm Hole
Mazda 2, 3, CX7, CX9,
MX3, MX5 Miata & RX8
1992 - On

UNIT PACKAGE: 15



21037
(000-990-84-92)
Black Nylon

Push-Type Retainer
Head Diameter: 10mm
Stem Length: 10mm
Fits Into 6mm Hole
Mercedes-Benz
2005-On

UNIT PACKAGE: 25



20187
(000-990-34-92)
Black Nylon

Radiator Housing
Push-Type Retainer
Head Diameter: 10mm
Stem Length: 10mm
Fits Into 6mm Hole
Body Styles 116, 123, 124, 136,
129, 140, 170, 201, 208, & 210
1974 - On

UNIT PACKAGE: 15



21103
(90467-05090-B1)
Black Nylon

Front Bumper Fascia
Push-Type Retainer
Head Diameter: 10mm
Stem Length: 12mm
Fits Into 5mm Hole
Toyota Corolla, Matrix & Scion
2008 - On

UNIT PACKAGE: 10



21233
(86157-3700)
Black Nylon

Hood Mounting
Push-Type Retainer
Head Diameter: 10mm
Stem Length: 13mm
Fits Into 5mm Hole
Hyundai Azera
2009 - On

UNIT PACKAGE: 25



11702
(D6EA-1A100-AA)
Natural Nylon

Wheel Ornament
Push-Type Retainer
Head Diameter: 25/64" (10mm)
Stem Length: 19/32" (15mm)
Fits Into 9/32" (7.1mm) Hole
Ford
1976 - On

UNIT PACKAGE: 50

PUSH-TYPE RETAINERS

Sec. 19

Listed smallest to largest first by Head Diameter then by Stem Length and then by Hole Diameter



19242
(15672149)
Black Nylon

Air Inlet Grille Panel
Push-Type Retainer
Head Diameter: 13/32" (10.3mm)
Stem Length: 11/16" (17.5mm)
Fits Into 7/32" (5/6mm) Hole
GM Jimmy, Blazer, S-10, & Bravada
1994 - On

UNIT PACKAGE: 25



21662
(S51S-51-833)
Black Nylon

Push-Type Retainer
Head Diameter: 11mm
Stem Length: 11mm
Fits Into 7mm Hole
Mazda 3, MX5 Miata & RX8
2004 - On

UNIT PACKAGE: 15



17383
(96057847)
Black Nylon

Radiator Grille & Trim Panel
Push-Type Retainer
Head Diameter: 11mm
Stem Length: 14mm
Fits Into 7mm Hole
Geo Tracker & Prizm
1992-89

UNIT PACKAGE: 10



11854
(14005089)
Natural Nylon

Air Conditioning Vent &
General Purpose
Push-Type Retainer
Head Diameter: 7/16" (11mm)
Stem Length: 9/32" (7.1mm)
Fits Into 3/16" (4.8mm) Hole
GM
1979 - On

UNIT PACKAGE: 25



14990
(22538102)
Black Nylon

Push-Type Retainer
Head Diameter: 7/16" (11mm)
Stem Length: 15/32" (11.9mm)
Fits Into 15/64" (6mm) Hole
GM
1987 - On

UNIT PACKAGE: 50



21249
(90467-07071-22)
Black Nylon

Bumper Cover
Push-Type Retainer
Head Diameter: 11mm
Stem Length: 14mm
Fits Into 7mm Hole
Toyota Yaris
2009 - On

UNIT PACKAGE: 25



21218
(90467-05063-C0)
Black Nylon

Front Bumper
Push-Type Retainer
Head Diameter: 11mm
Stem Length: 8mm
Fits Into 5mm Hole
Toyota Corolla
2009 - On

UNIT PACKAGE: 15

**Refer To Push-Type
Retainer Specification
Chart On Pages 450 - 460**



14988
(Ford: N805229S;
GM: 15648833,
22595587)
Black Nylon

Push-Type Retainer
Head Diameter:
7/16" (11mm)
Stem Length: 11/16" (17.5mm)
Fits Into 15/64" (6mm) Hole
Ford & GM
1987 - On

UNIT PACKAGE: 25



19186
(90657-SB0-003)
Black Nylon

Front Bumper Cover
Push-Type Retainer
Head Diameter: 11mm
Stem Length: 10mm
Fits Into 8mm Hole
Acura Legend, Honda
Accord & Odyssey
1991 - On

UNIT PACKAGE: 10



18933
(15676045)
Black Nylon

Rear Window Wiper Motor Cover
& Dash Board
Push-Type Retainer
Head Diameter: 7/16" (11mm)
Stem Length: 1/2" (12.7mm)
Fits Into 1/4" (6.4mm) Hole
GM Trucks C & K, 1, 2
1991 - On

UNIT PACKAGE: 25



17214
(GM: 10089262, 21042098;
Chrysler: 55075139)
Black Nylon

Push-Type Retainer
Head Diameter: 11mm (7/16")
Stem Length: 18mm (11/16")
Fits Into 6mm (15/64") Hole
GM & Saturn 4 Door &
Station Wagon
1987 - On

UNIT PACKAGE: 25

14987
Same As 17214 Except Packaging
UNIT PACKAGE: 50

Listed smallest to largest first by Head Diameter then by Stem Length and then by Hole Diameter



19788

(10246149; 22657634)
Black Nylon

Rocker Panel
Push-Type Retainer
Head Diameter: 11mm
Stem Length: 20mm
Fits Into 6mm Hole
GM Achieva, Cutlass, Grand Am
& Malibu
1999 - On

UNIT PACKAGE: 25



18032

(6502573)
Black Nylon

Cowl Screen Attachment
Push-Type Retainer
Head Size: 15/32" (11.9mm)
Stem Length: 9/16" (14.3mm)
Fits Into 1/4" (6.4mm) Square Hole
Chrysler Concorde & LHS,
Dodge Intrepid & Eagle Vision
1993 - On

UNIT PACKAGE: 15



16783

(66824-01G00)
Black Nylon

Push-Type Retainer
Head Diameter: 12mm
Stem Length: 8mm
(Not Including The Pin)
Fits Into 6mm Hole
Nissan

UNIT PACKAGE: 25



20636

(123-990-00-92)
Dark Gray Nylon

Push-Type Retainer
Head Diameter: 12mm
Stem Length: 10mm
Fits Into 8.5mm Hole
Mercedes-Benz

UNIT PACKAGE: 15



21391

(N038-550-1)
Dark Gray Nylon

Bumper, Exterior Trim, Fender,
Quarter Panel & Wheel Opening
Push-Type Retainer
Head Diameter: 12mm
Stem Length: 11mm
Fits Into 8mm Hole
Audi and Volkswagen EuroVan,
Golf, Jetta & Passat
2003 - 1985

UNIT PACKAGE: 25



20639

(000-990-44-92)
Black Nylon

Push-Type Retainer
Head Diameter: 12mm
Stem Length: 11mm
Fits Into 5mm x 5mm Hole
Mercedes-Benz

UNIT PACKAGE: 25

**Refer To Push-Type
Retainer Specification
Chart On Pages 450 - 460**



20640

(000-990-40-92,
124-990-05-92-9051)
Black Nylon

Push-Type Retainer
Head Diameter: 12mm
Stem Length: 11mm
Fits Into 5mm Hole
Mercedes-Benz

UNIT PACKAGE: 25



20666

(22677979, 22677980)
Gray Nylon

Door Trim
Push-Type Retainer
Head Diameter: 12mm
Stem Length: 14mm
(Excluding The Pin)
Fits Into 6mm Hole
Chevrolet Malibu
2004 - On

UNIT PACKAGE: 25



21246

(22690838)
Black Nylon

Door Trim
Push-Type Retainer
Head Diameter: 12mm
Stem Length: 14mm (Exc. Pin)
Fits Into 6mm Hole
Chevrolet Malibu & Pontiac G6
2004 - On

UNIT PACKAGE: 25



19787

(22657634)
Black Nylon

Fender & Rocker Panel
Push-Type Retainer
Head Diameter: 12mm
Stem Length: 17mm
Fits Into 6mm Hole
Chevrolet Malibu, Oldsmobile
Achieva & Cutlass and
Pontiac Grand Am
1999 - On

UNIT PACKAGE: 25



19522

(22644361)
Black Nylon

Door Sill Trim Plate
Push-Type Retainer
Head Diameter: 12mm
Stem Length: 18mm
Fits Into 6mm Square Hole
Chevrolet Malibu, Olds Achieva
& Cutlass
1997 - On

UNIT PACKAGE: 15

Listed smallest to largest first by Head Diameter then by Stem Length and then by Hole Diameter



20163
(25099299)
Black Nylon

Radiator Sight Shield &
Air Filter Housing
Push-Type Retainer
Head Diameter: 12.5mm
Stem Length: 17mm
Fits Into 6mm Hole
GM
1994 - On

UNIT PACKAGE: 15



21595
(Not Available
From O.E.M.)
Natural Nylon

General Purpose
Push-Type Retainer
Head Diameter: 12.7mm (1/2")
Stem Length: 31mm (1-7/32")
Fits Into 7mm Hole (9/32")
Universal

UNIT PACKAGE: 50



20314
(000-990-37-92)
Black Nylon

Trunk Trim & General Purpose
Push-Type Retainer
Head Diameter: 13mm
Stem Length: 14mm
Fits Into 8mm Hole
Mercedes-Benz SL500 &
SL600 Convertible
1999 - On

UNIT PACKAGE: 15



17106
(GM: 22566221;
Chrysler: 6501577)
Black Nylon

Headlight Door Push-Type Retainer
Large Head Diameter: 1/2" (12.7mm)
Stem Length: 7/16" (11mm)
Fits Into 3/16" (4.8mm) Hole
GM Blazer & Suburban
1991 - On
Chrysler New Yorker, Landau &
5th Avenue
1988 - On

UNIT PACKAGE: 50

**Refer To Push-Type
Retainer Specification
Chart On Pages 450 - 460**



14963
(4248294, F155DT3)
Light Palomino Nylon

Interior Trim
Push-Type Retainer
Large Head Diameter: 13mm
Stem Length: 7mm
(Excluding The Pin)
Fits Into 7mm Square Hole
Chrysler
1987 - On

UNIT PACKAGE: 25



21172
(W713202-S300,
W713445-S300)
Black Nylon

Bumper Push-Type Retainer
Head Diameter: 13mm
Stem Length: 18mm
Fits Into 8mm Hole
Ford Fusion
2006 - On

UNIT PACKAGE: 15



14995
(GM: 10195515;
Ford: N805026S;
Chrysler: 4696488,
6503163)
Black Nylon

Push-Type Retainer
Head Diameter: 1/2" (12.7mm)
Stem Length: 1-13/64" (30.5mm)
Fits Into 9/32" (7mm) Hole
GM, Ford & Chrysler
1987 - On

UNIT PACKAGE: 25



17287
(90687-SB0-003,
90687-SB0-013)
Black Nylon

Cowl Vent Panel Retainer
Head Diameter: 13mm
Stem Length: 11mm
Fits Into 6mm Hole
Honda Prelude
1983 - On

UNIT PACKAGE: 25



19355
(15960621)
Black Nylon

Rear Door Radio Speaker
Push-Type Retainer
Head Diameter: 17/32" (13.5mm)
Stem Length: 1-5/64" (27.5mm)
Fits Into 1/4" (6.4mm) Hole
GM Trucks C & K 1, 2
1995 - On

UNIT PACKAGE: 25

Listed smallest to largest first by Head Diameter then by Stem Length and then by Hole Diameter



20196

(90467-06133-CO)
Black Nylon

Rocker Panel
Push-Type Retainer
Head Diameter: 14mm
Stem Length: 8mm
Fits Into 6mm Hole
Toyota 4-Runner
1998 - On

UNIT PACKAGE: 15



21451

(333-867-633-4FB)
Black Nylon

Front Lights & Windshield Washer
Push-Type Retainer
Head Diameter: 14mm
Stem Length: 10mm
Fits Into 8.5mm Hole
VW
1998 - 95

UNIT PACKAGE: 25



21104

(90467-07190-B2)
Black Nylon

Interior Trim
Push-Type Retainer
Head Diameter: 14mm
Stem Length: 14mm
Fits Into 7mm Hole
Toyota Echo & Scion
2004 - On

UNIT PACKAGE: 10

**Refer To Push-Type
Retainer Specification
Chart On Pages 450 - 460**



19726

(94858343)
Black Nylon

Door Trim Panel
Push-Type Retainer
Head Diameter: 14mm
Stem Length: 8mm
Fits Into 6mm Hole
Geo Prizm
1998 - On

UNIT PACKAGE: 15



14697

(GM: 94198687;
Honda: 90657-SA6-0030;
Mazda: N304-13-356-A)
Black Nylon

Push-Type Retainer
Head Diameter: 14mm
Stem Length: 11mm
Fits Into 7mm Hole

UNIT PACKAGE: 25



17478

(B101-68-252-00)
Black Nylon

Interior Trim
Push-Type Retainer
Head Diameter: 14mm
Stem Length: 16mm
Fits Into 6mm Hole
Ford Probe & Mazda MX6
1988 - On

UNIT PACKAGE: 25



19645

(94858864)
Gray Nylon

Door Trim Panel
Push-Type Retainer
Head Diameter: 14mm
Stem Length: 8mm
Fits Into 6mm Hole
Geo Prizm
1998 - On

UNIT PACKAGE: 15



16816

(21047094)
Black Nylon

Push-Type Retainer
Large Head Diameter: 14mm
Stem Length: 14mm
Fits Into 6mm Hole
GM Saturn
1991 - On

UNIT PACKAGE: 25



16859

(Nissan: 66860-01W01;
GM: 94051993)
Black Nylon

Cowl Panel To Reinforcement Plate
& Engine Splash Shield
Push-Type Retainer
Head Diameter: 14mm (9/16")
Stem Length: 16mm (5/8")
Fits Into 6mm (1/4") Hole
Nissan
1980 - On
Geo Storm
1990 - On

UNIT PACKAGE: 25

Listed smallest to largest first by Head Diameter then by Stem Length and then by Hole Diameter



19337

(N808908-S)
Black Nylon

Headlight Accessory
Push-Type Retainer
Head Diameter: 14mm
Stem Length: 23mm
Fits Into 6.3mm (1/4") Hole
Ford Mustang
1996 - On

UNIT PACKAGE: 10



20943

(15014352)
Black Nylon

Cowl Vent
Push-Type Retainer
Head Diameter: 14mm
Stem Length: 23mm
Fits Into 7mm Hole
Buick Lucerne
2006 - On

UNIT PACKAGE: 15



18353

(15960325)
White Nylon

Door Trim Panel
Push-Type Retainer
Head Diameter: 9/16" (14.3mm)
Stem Length: 41/64" (16.3mm)
Fits Into 1/4" (6.4mm) Hole
GM Trucks C, K, 1, 2, 3
1995 - On

UNIT PACKAGE: 50



21593

(46064-AE000)
Black Nylon

Front Fender,
Bumper & Quarter Panel
Push-Type Retainer
Head Diameter: 15mm
Stem Length: 8mm
Fits Into 7mm Hole
Subaru Baja, Forester, Impreza,
Legacy & Outback
2003 - On

UNIT PACKAGE: 10



20772

(001-990-13-92)
Black Nylon

Back Glass Moulding
Push-Type Retainer
Head Diameter: 15mm
Stem Length: 11mm
Fits Into 5mm Hole
Mercedes-Benz C & SL Class
2001 - On

UNIT PACKAGE: 15

**Refer To Push-Type
Retainer Specification
Chart On Pages 450 - 460**



21328

(86155-2H100)
Black Nylon

Cowl & Bumper Push-Type Retainer
Head Diameter: 15mm
Stem Length: 10mm
Fits Into 7mm Hole
Hyundai Genesis & Veracruz
and Kia Rio
2009 - On

UNIT PACKAGE: 15



14696

(Honda: 90684-SA5-0030;
Isuzu: 8942981190;
Nissan 10998-30880)
Black Nylon

Push-Type Retainer
Head Diameter: 15mm
Stem Length: 11mm
Fits Into 6mm Hole

UNIT PACKAGE: 25



19013

(90467-07059-22)
Black Nylon

Rear Door Trim & Luggage
Compartment Door
Push-Type Retainer
Head Diameter: 15mm
Stem Length: 10mm
Fits Into 7mm Hole
Toyota Camry & Celica
1990 - On

UNIT PACKAGE: 15



21658

(MR288150)
Black Nylon

Push-Type Retainer
Head Diameter: 15mm
Stem Length: 11mm
Fits Into 6mm Hole
Mitsubishi Endeavor, Galant, Lancer,
Mirage, Montero & Outlander
1997 - On

UNIT PACKAGE: 10

Listed smallest to largest first by Head Diameter then by Stem Length and then by Hole Diameter



21140
(MB619582)
Black Nylon

Interior Trim, Bumper & Grille
Push-Type Retainer
Head Diameter: 15mm
Stem Length: 12mm
Fits Into 6.3mm Hole
Mitsubishi Eclipse,, Endeavor,
Lancer & Outlander
2002 - On

UNIT PACKAGE: 25



14260

(Toyota: 90467-06017; Mazda:
9926-50-625; GM: 20426301)
Black Nylon

Push-Type Retainer
Head Diameter: 15mm
Stem Length: 12mm
Fits Into 7mm Hole

UNIT PACKAGE: 15



20580
(MR478262)
Black Nylon

Bumper Cover & Garnish Moulding
Push-Type Retainer
Top Head Diameter: 15mm
Bottom Head Diameter: 14mm
Stem Length: 12mm
Fits Into 7mm Hole
Use With Auveco 20581
Chrysler Sebring & Stratus And
Mitsubishi Eclipse
2000 - On

UNIT PACKAGE: 15



17206
(90467-09145)
Black Nylon

Bumper Cover
Push-Type Retainer
Head Diameter: 15mm
Stem Length: 12mm
Fits Into 9mm Hole
Toyota Camry
1992 - On

UNIT PACKAGE: 15

**Refer To Push-Type
Retainer Specification
Chart On Pages 450 - 460**



19311
(90683-SA5-003)
Black Nylon

Front Fender Skirt
Push-Type Retainer
Head Diameter: 15mm
Stem Length: 13mm
Fits Into 6mm Hole
Honda Prelude
1996 - 92

UNIT PACKAGE: 15



20363
(Not Available
From O.E.M.)
White Nylon

Door Trim Panel
Push-Type Retainer
Top Head Diameter: 15mm
Bottom Head Diameter: 20mm
Stem Length: 12mm
(Excluding The Pin)
Fits Into 9mm Hole
Ford
2001 - On

UNIT PACKAGE: 25



19142
(91550-SH3-003)
Black Nylon

Pillar Garnish, Side And
Trunk Lining
Push-Type Retainer
Head Diameter: 15mm
Stem Length: 13mm
Fits Into 7mm Square Hole
Honda Civic, Accord Wagon
& Del Sol
1993 - On

UNIT PACKAGE: 5



17162
(GM: 96057846;
Toyota: 90467-07041)
Black Nylon

Push-Type Retainer
Head Diameter: 15mm
Stem Length: 13mm
Fits Into 6.3mm Hole
Geo Metro & Tracker And Toyota
1989 - On

UNIT PACKAGE: 10



20169
(W701971-S)
White Nylon

Door Trim Panel
Push-Type Retainer
Head Diameter: 15mm
Stem Length: 13mm
Fits Into 7mm Hole
Lincoln LS
2000 - On

UNIT PACKAGE: 25

PUSH-TYPE RETAINERS

Sec. 19

Listed smallest to largest first by Head Diameter then by Stem Length and then by Hole Diameter



21620
(01553-06071)
Black Nylon

Rear Duct Finishing Panel
Push-Type Retainer
Head Diameter: 15mm
Stem Length: 14mm
Fits Into 5mm Hole
Nissan Cube S, SL,
Krom & Leaf
2012 - On

UNIT PACKAGE: 15



21112
(94530438)
Black Nylon

Fender Liner
Push-Type Retainer
Head Diameter: 15mm
Stem Length: 14mm
Fits Into 6mm Hole
Chevrolet Aveo
2004 - On

UNIT PACKAGE: 25



21120
(90467-07192)
Black Nylon

Cowl Vent
Push-Type Retainer
Head Diameter: 15mm
Stem Length: 14mm
Fits Into 7mm Hole
Toyota RAV 4
2002 - On

UNIT PACKAGE: 15



20234
(51-11-1-908-077)
Black Nylon

Scuff Plate
Push-Type Retainer
Head Diameter: 15mm
Stem Length: 15mm
Fits Into 6.3mm Hole
BMW Series 3, 5 & 7
1984 - On

UNIT PACKAGE: 50



21645
(Not Available
From O.E.M.)
Black Nylon

Bumper & Wheel Opening
Push-Type Retainer
Head Diameter: 15mm
Stem Length: 15mm
Fits Into 6.3mm Hole
BMW 2004 - On

UNIT PACKAGE: 15

**Refer To Push-Type
Retainer Specification
Chart On Pages 450 - 460**



11705
(387843-S)
Black Nylon

Fender Shield Retainer
Head Diameter:
19/32" (15mm)
Stem Length: 5/8" (16mm)
Fits Into 1/4" (6.4mm) Hole
Ford 1978 - On

UNIT PACKAGE: 50



21011
(90467-07188)
Black Nylon

Push-Type Retainer
Head Diameter: 15mm
Stem Length: 17mm
Fits Into 7mm Hole
Toyota Camry, Tundra & 4-Runner
2002 - On

UNIT PACKAGE: 15



19801
(21077123)
Black Nylon

Wheel Opening Moulding
Push-Type Retainer
Head Diameter:
19/32" (15mm)
Stem Length: 3/4" (19mm)
Fits Into 1/4" (6.4mm) Hole
Saturn
1991 - On

UNIT PACKAGE: 25



17222
(GM: 11561878, 21075686;
Ford: F3LY-14570-B)
Black Nylon

Rocker Panel,
Wheel Liner & Air Inlet Duct
Push-Type Retainer
Head Diameter: 15mm
Stem Length: 20mm
Fits Into 8mm Hole
GM Saturn
2 Door & 4 Door Models
1991 - On

Ford

UNIT PACKAGE: 25



14997
(10053182)
Black Nylon

Push-Type Retainer
Head Diameter: 19/32" (15mm)
Stem Length: 13/16" (20.6mm)
Fits Into 5/16" (8mm) Hole
GM

1987 - On

UNIT PACKAGE: 25



17103
(GM: 15681408;
Ford: N803709S)
Black Nylon

Fascia Retainer
Head Diameter: 15mm
Stem Length: 23mm
Fits Into 6mm Hole
GM & Ford
1986 - On

UNIT PACKAGE: 50



14992
(Ford: N803946S;
Chrysler: 6502871)
Black Nylon

Push-Type Retainer
Head Diameter:
19/32" (15mm)
Stem Length: 29/32" (23mm)
Fits Into 1/4" (6.4mm) Hole
Ford & Chrysler
1987 - On

UNIT PACKAGE: 50

Listed smallest to largest first by Head Diameter then by Stem Length and then by Hole Diameter



19511

(W704958-S300)
White Nylon

Rear Door Lower Trim Panel
Push-Type Retainer
Round Head Diameter:
19/32" (15mm)
Wedge Shaped Head
Diameter: 29/32" (23mm)
Stem Length: 11/16" (17.5mm)
Fits Into 3/8" (9.5mm)
Lincoln Town Car
1998 - On

UNIT PACKAGE: 25



17226

(10207146, 21077323)
Black Nylon

Rear Door Rocker Panel To
Underbody Bracket
Push-Type Retainer
Head Diameter: 15mm
Stem Length: 29mm
Fits Into 8mm Hole
GM Saturn
4 Door Models
1991 - On

UNIT PACKAGE: 25



19243

(GM: 30008324; Suzuki:
09409-07325)
Black Nylon

Push-Type Retainer
Head Diameter: 16mm
Stem Length: 10mm
(Excluding The Pin)
Fits Into 9mm Hole
Front & Rear Bumper Fascia
Geo Metro 1989 - On
Radiator Grille
Suzuki Esteem 1995 - On

UNIT PACKAGE: 15

**Refer To Push-Type
Retainer Specification
Chart On Pages 450 - 460**



17439

(90467-09093)
Black Nylon

Bumper Cover
Push-Type Retainer
Head Diameter: 15mm
Stem Length: 27mm
Fits Into 9mm Hole
Lexus LS-400

UNIT PACKAGE: 10



19552

(90467-07146)
Black Nylon

Cowl Panel & Luggage
Compartment Retainer
Head Diameter: 16mm
Stem Length: 9mm
Fits Into 7mm Hole
Toyota Avalon, Camry,
Celica & Solara
1993 - On

UNIT PACKAGE: 15



21570

(90914-0012)
Black Nylon

Rear Light Reflector & Roof Spoiler
Push-Type Retainer
Head Diameter: 16mm
Stem Length: 11mm
Fits Into 6mm Hole
Subaru B9 Tribeca, Impreza,
Legacy & Outback
2005 - On

UNIT PACKAGE: 25



19219

(90467-09096)
Black Nylon

Front Bumper
Push-Type Retainer
Head Diameter: 15mm
Stem Length: 27mm
Fits Into 9mm Hole
Lexus LS400 and
Toyota Celica & Supra
1989 - On

UNIT PACKAGE: 10



21624

(90467-10206)
Black Nylon

Cowl Push-Type Retainer
Head Diameter: 16mm
Stem Length: 10mm
Fits Into 8mm Hole
Lexus ES 350, RX350
& RX 450H and
Toyota Camry, Sequoia,
Tundra & Yaris
2006 - On

UNIT PACKAGE: 15



21044

(123-990-05-92, 126-990-03-92)
Black Nylon

Cowl Screen Cover
Push-Type Retainer
Head Diameter: 16mm
Stem Length: 11mm
Fits Into 6.3mm Hole
Mercedes-Benz E, CL & S Class
2000 - On

UNIT PACKAGE: 15

Listed smallest to largest first by Head Diameter then by Stem Length and then by Hole Diameter



20310
(383142-S)
Black Nylon

Grille To Headlight Bracket
Push-Type Retainer
Head Diameter: 5/8" (16mm)
Stem Length: 7/16" (11mm)
Fits Into 1/4" (6.4mm) Hole
Ford

UNIT PACKAGE: 50



19306
(GA5R-56-392)
Black Nylon

Shroud Seal Board
Push-Type Retainer
Head Diameter: 16mm
Stem Length: 12mm
Fits Into 6mm Hole
Mazda 626
1994 - On

UNIT PACKAGE: 10



19297
(21035345)
Black Nylon

Liftgate Upper Window
& Lower Garnish Moulding
Push-Type Retainer
Head Diameter: 16mm
Stem Length: 12mm
(Excluding The Pin)
Fits Into 7mm Hole
GM Saturn 1998 - 93

UNIT PACKAGE: 15



19249
(3512624-2)
Black Nylon

Rocker Panel
Push-Type Retainer
Head Diameter: 16mm
Stem Length: 12mm
Fits Into 8mm Hole
Volvo
1993 - On

UNIT PACKAGE: 25



19195
(161-867-299-01C)
Black Nylon

Push-Type Retainer
Head Diameter: 16mm
Stem Length: 12mm
Fits Into 8mm Hole
VW Golf & Jetta
1997 - 93

UNIT PACKAGE: 25



19607
(XL3Z-17E971-AA)
Natural Nylon

Front Bumper Cover
Push-Type Retainer
Head Diameter: 16mm
Stem Length: 12mm
Fits Into 10mm Hole
Ford F150 & F250 Trucks
1999 - On

UNIT PACKAGE: 25

**Refer To Push-Type
Retainer Specification
Chart On Pages 450 - 460**



21566
(91085-TA030)
Black Nylon

Push-Type Retainer
Head Diameter: 16mm
Stem Length: 13mm
Fits Into 7mm Hole
Subaru Baja, Impreza,
Legacy & Outback
2000 - On

UNIT PACKAGE: 25



21601
(06509673AA)

White Nylon With Black Rubber Seal

Push-Type Retainer
Top Head Diameter: 16mm
Middle Head Diameter: 18mm
Bottom Head Diameter: 22mm
Stem Length: 16mm
Fits Into 9mm Hole
Chrysler 300 & Magnum and Jeep
Grand Cherokee & Wrangler
2011 - On

UNIT PACKAGE: 15



15522
(N805231S)
Black Nylon

Push-Type Retainer
Head Diameter: 5/8" (16mm)
Stem Length: 17/32" (13.5mm)
Fits Into 1/4" (6.4mm) Hole
Ford Taurus, Topaz & Sable
1989 - On

UNIT PACKAGE: 50



19248
(1268176-3)
Black Nylon

Bumper Cover
Push-Type Retainer
Head Diameter: 16mm
Stem Length: 14mm
Fits Into 6mm Hole
Volvo 740 & 760
1993 - On

UNIT PACKAGE: 15

Listed smallest to largest first by Head Diameter then by Stem Length and then by Hole Diameter



21190
(91550-S50-000ZL)
Black Nylon

Interior Trim Push-Type Retainer
Head Diameter: 16mm
Stem Length: 14mm
Fits Into 7mm Hole
Honda Civic, CR-V Element & Insight
2000 - On

UNIT PACKAGE: 15



20909
(124-990-04-92)
Black Nylon

Push-Type Retainer
Head Diameter: 16mm
Stem Length: 18mm
Fits Into 7mm Hole
Mercedes-Benz
2003 - On

UNIT PACKAGE: 15



20542
(15994165)
Black Nylon

Bumper & Rear Wheel Apron
Push-Type Retainer
Head Diameter: 16.5mm
Stem Length: 27mm
Fits Into 8mm Hole
Saturn L Series
2000 - On

UNIT PACKAGE: 25



21477
(91550-S50-000ZK)
Gray Nylon

Push-Type Retainer
Head Diameter: 16mm
Stem Length: 14mm
Fits Into 7mm Hole
Honda Civic, CR-V Element & Insight
2000 - On

UNIT PACKAGE: 15



18265
(76882-57A00)
Black Nylon

Body Side Moulding
Push-Type Retainer
Head Diameter: 16mm
Stem Length: 20mm
Fits Into 8mm Hole
Nissan Sentra
1986 - On

UNIT PACKAGE: 25



14011
(14019226, 14071289)
Black Nylon

Radiator Overflow Bottle/Windshield
Washer Bottle Retainer
Head Diameter: 21/32" (16.7mm)
Stem Length: 9/16" (14.3mm)
Fits Into 5/16" (8mm) Hole
GM 1981 - On

UNIT PACKAGE: 25



21325
(90080-46294)
Black Nylon

Turn Signal Light & General Purpose
Push-Type Retainer
Head Diameter: 16mm
Stem Length: 14mm
Fits Into 7mm Hole
Toyota Tundra
2003 - On

UNIT PACKAGE: 10

**Refer To Push-Type
Retainer Specification
Chart On Pages 450 - 460**



20352
(91561-S84-A00-M1)
Black Nylon

Rear Panel Assembly
Push-Type Retainer
Head Diameter: 16mm
Stem Length: 21mm
Fits Into 8mm Hole
Honda

UNIT PACKAGE: 10



14001
(14039420)
Black Nylon

Push-Type Retainer
Head Diameter:
21/32" (16.7mm)
Stem Length:
19/32" (15mm)
Fits Into 5/16" (8mm) Hole
GM (Including Saturn)

UNIT PACKAGE: 25



19904
(9133417-7)
Black Nylon

Rocker Panel
Push-Type Retainer
Head Diameter: 16mm
Stem Length: 14mm
Fits Into 9mm Hole
Volvo 850 Series
1994 - On

UNIT PACKAGE: 15



18270
(90467-07117)
Black Nylon

Push-Type Retainer
Head Diameter: 17mm
Stem Length: 9mm
Fits Into 7mm Hole
Lexus
1990 - On

UNIT PACKAGE: 10

Listed smallest to largest first by Head Diameter then by Stem Length and then by Hole Diameter



18165
(91508-SR3-000)
Black Nylon

Cowl Panel
Push-Type Retainer
Head Diameter: 17mm
Stem Length: 9mm
Fits Into 8mm Hole
Honda
1990 - On

UNIT PACKAGE: 10



17351
(MB-253964)
Black Nylon

Front & Rear Bumper
Push-Type Retainer
Head Diameter: 17mm
Stem Length: 10mm
Fits Into 7mm Hole
Mitsubishi Tredia
1988-83

UNIT PACKAGE: 10



20910
(91505-ST7-003ZA)
Black Nylon

Door Panel
Push-Type Retainer
Head Diameter: 17mm
Stem Length: 12mm
Fits Into 8mm Hole
Honda CR-V and S2000
2000 - On

UNIT PACKAGE: 10



19232
(91502-SZ5-003)
Black Nylon

Front Fender
Push-Type Retainer
Head Diameter: 17mm
Stem Length: 13mm
Fits Into 7mm Hole
Acura 3.5 RL Sedan
1996 - On

UNIT PACKAGE: 10



19547
(91508-S50-003)
Black Nylon

Cowl Top Retainer
Head Diameter: 17mm
Stem Length: 13mm
(Excluding The Pin)
Fits Into 9mm Hole
Honda Accord & Odyssey
1998 - On

UNIT PACKAGE: 5



15672
(8880417)
Black Nylon

Push-Type Retainer
Head Diameter: 17mm
Stem Length: 14mm
Fits Into 8mm (5/16") Hole
Chrysler
1987 - On

UNIT PACKAGE: 25

**Refer To Push-Type
Retainer Specification
Chart On Pages 450 - 460**



19546
(91570-SK7-003ZF)
Black Nylon

Tailgate Lining Retainer
Head Diameter: 17mm
Stem Length: 16mm
Fits Into 7mm Square Hole
Honda Prelude
1997 - On

UNIT PACKAGE: 10



19639
(GM: 15149708;
Chrysler: 6506008AA)
Black Nylon

Radiator Wheelhouse, Fender &
Front Bumper Cover
Push-Type Retainer
Head Diameter: 17mm
Stem Length: 16mm
Fits Into 6mm Hole
GM C & K Trucks
1999 - On
Jeep Liberty
2002 - On

UNIT PACKAGE: 25



16624
(1636632, 20687704)
Black Nylon

Front Bumper Fascia
Push-Type Retainer
Head Diameter: 17mm
Shoulder Length: 2mm
Stem Length: 18mm
Fits Into 9.5mm (3/8") Hole
Buick Riviera/Reatta
1988 - On

UNIT PACKAGE: 25



14726
(63844-01A99)
Black Nylon

Push-Type Retainer
Head Diameter: 17mm
Stem Length: 18mm
Fits Into 8mm Hole
Nissan

UNIT PACKAGE: 25

Listed smallest to largest first by Head Diameter then by Stem Length and then by Hole Diameter



13457

(20451119)
Black Nylon

Front Compartment
Spare Tire Retainer
Head Diameter:
43/64" (17mm)

Stem Length: 23/32" (18.3mm)
Fits Into 5/16" (8mm) Hole
GM

UNIT PACKAGE: 10



11699

(GM: 472434;
Chrysler: 6031390)
Black Nylon

Cowl Ledge Weatherstrip
& Fender Liner
Push-Type Retainer
Head Diameter: 11/16" (17.5mm)
Stem Length: 5/8" (16mm)
Fits Into 1/4" (6.4mm)

GM 1970 - On
Chrysler 1968 - On

UNIT PACKAGE: 50



18894

(N807578-S,
N808332-S)
Black Nylon

Trim Panel
Push-Type Retainer
Head Diameter: 11/16" (17.5mm)
Stem Length: 3/4" (19mm)
Fits Into 1/4" (6.4mm) Hole
Ford

UNIT PACKAGE: 15



11704

(6031383)
Black Nylon

Grille Retainer
Head Diameter:
11/16" (17.5mm)

Stem Length: 7/16" (11mm)
Fits Into 9/32" (7.1mm) Hole
Chrysler 1978 - On

UNIT PACKAGE: 25



18327

(6503454)
Black Nylon

Front Bumper Fascia
Push-Type Retainer
Head Diameter: 11/16" (17.5mm)
Stem Length: 5/8" (16mm)
Fits Into 1/4" (6.4mm) Hole
Jeep Grand Cherokee
1994 - On

UNIT PACKAGE: 25



18030

(Chrysler: 6501925;
GM: 10134407)
Black Nylon

Push-Type Retainer
Head Diameter: 11/16" (17.5mm)
Stem Length: 13/16" (20.6mm)
Fits Into 1/4" (6.4mm) Hole
Chrysler Concorde & LHS
Dodge Intrepid & Eagle Vision
1993 - On
Coolant Recovery Reservoir
GM 1992 - On

UNIT PACKAGE: 25



18893

(N806322-S)
Black Nylon

Trim Panel
Push-Type Retainer
Head Diameter:
11/16" (17.5mm)

Stem Length: 1/2" (12.7mm)
Fits Into 1/4" (6.4mm) Hole
Ford

UNIT PACKAGE: 15

**Refer To Push-Type
Retainer Specification
Chart On Pages 450 - 460**



12567

(GM: 14019205,
14019206, 16514113;
Chrysler: 34201621,
6504090)
Black Nylon

Front Fender Mud Skirt
& Fender Liner
Push-Type Retainer

Head Diameter: 11/16" (17.5mm)
Stem Length: 9/16" (14.3mm)
Fits Into 1/4" (6.4mm) Hole
GM 1981 - On

UNIT PACKAGE: 25



14991

(GM: 10139822,
25680782; Ford: N808147S)
Black Nylon

Push-Type Retainer
Head Diameter: 11/16" (17.5mm)
Stem Length: 11/16" (17.5mm)
Fits Into 1/4" (6.4mm) Hole
GM & Ford 1987 - On

UNIT PACKAGE: 25



13993

(GM: 20510029;
Ford: N803362-S;
Chrysler: 34202672)
Black Nylon

Body Retainer
Head Diameter: 11/16" (17.5mm)
Stem Length: 7/8" (22mm)
Fits Into 1/4" (6.4mm) Hole
GM 1984 - On
Ford 1984 - On

UNIT PACKAGE: 25

14007

Same As 12567 Except Packing

UNIT PACKAGE: 50

Listed smallest to largest first by Head Diameter then by Stem Length and then by Hole Diameter



14753

(GM: 15773445,
20452072,
20664092;
Ford N804570S;
Chrysler: 4638136)
Black Nylon

Radiator Shroud & Trim Retainer
Head Diameter: 11/16" (17.5mm)
Stem Length: 7/8" (22mm)
Fits Into 1/4" (6.4mm) Hole
GM 1982 - On
Ford 1986 - On
Chrysler 1998 - On
UNIT PACKAGE: 25



14993

(22538004)
Black Nylon

Push-Type Retainer
Head Diameter:
11/16" (17.5mm)
Stem Length: 7/8" (22mm)
Fits Into 1/4" (6.4mm) Hole
GM 1987 - On
UNIT PACKAGE: 25



13996

(20452072, 20590899)
Black Nylon

Exterior Body Retainer
Head Diameter:
11/16" (17.5mm)
Stem Length: 7/8" (22mm)
Fits Into 9/32" (7.1mm) Hole
GM 1984 - On
UNIT PACKAGE: 25



18895

(N807577-S,
N808331-S)
Black Nylon

Trim Panel
Push-Type Retainer
Head Diameter:
11/16" (17.5mm)
Stem Length:
1-3/32" (28mm)
Fits Into 1/4" (6.4mm) Hole
Ford Aerostar & Windstar
UNIT PACKAGE: 15



20335

(53879-60010)
Black Nylon

Fender Liner
Push-Type Retainer
Head Diameter: 18mm
Stem Length: 7mm
Fits Into 7mm Hole
Toyota Land Cruiser & RAV 4
1998 - On
UNIT PACKAGE: 15

UNIT PACKAGE: 15

**Refer To Push-Type
Retainer Specification
Chart On Pages 450 - 460**



20869

(GM: 88970767; Toyota:
90467-10183)
Black Nylon

Front Fender Liner
Push-Type Retainer
Head Diameter: 18mm
Stem Length: 7.5mm
Fits Into 7mm Hole
Toyota Celica, Corolla, Matrix &
Solara, Lexus And Pontiac Vibe
1999 - On
UNIT PACKAGE: 10

UNIT PACKAGE: 10



19490

(90467-06150)
Black Nylon

Back Garnish Trim Panel
Push-Type Retainer
Head Diameter: 18mm
Stem Length: 8mm
Fits Into 6mm Hole
Toyota Tacoma
1995 - On
UNIT PACKAGE: 10

UNIT PACKAGE: 10



20465

(UB39-45-919)
Black Nylon

Front & Rear Fender
Push-Type Retainer
Head Diameter: 18mm
Stem Length: 9mm
Fits Into 8mm Hole
Mazda 626
2000 - On
UNIT PACKAGE: 10

UNIT PACKAGE: 10



21024

(5R3Z-54310D12-AAA)
Black Nylon

Trim Panel
Push-Type Retainer
Head Diameter: 18mm
Stem Length: 10mm
Fits Into 6mm Hole
Ford Mustang
2005 - On
UNIT PACKAGE: 15

UNIT PACKAGE: 15



21530

(90913-0067)
Black Nylon

Engine Cover and Fender Liner
Push-Type Retainer
Head Diameter: 18mm
Stem Length: 10mm
Fits Into 8mm Hole
Subaru B9, Forester, Legacy,
Outback & Tribeca 2005 - On
UNIT PACKAGE: 15

UNIT PACKAGE: 15



19747

(UB39-50-795)
Black Nylon

Stone Guard
Push-Type Retainer
Head Diameter: 18mm
Stem Length: 10mm
Fits Into 8mm Hole
Mazda MPV
1998 - On
UNIT PACKAGE: 10

UNIT PACKAGE: 10

Listed smallest to largest first by Head Diameter then by Stem Length and then by Hole Diameter



21547
(90467-09185)
Black Nylon

Front Spoiler & Grille
Push-Type Retainer
Head Diameter: 18mm
Stem Length: 10mm
Fits Into 9mm Hole
Lexus HS 250h and Toyota Celica,
Sequoia, Sienna & 4-Runner
1994 - On

UNIT PACKAGE: 25



18206
(GJ21-68885-B69)
Gray Nylon

Push-Type Retainer
Head Diameter: 18mm
Stem Length: 12mm
Fits Into 6mm Hole
Ford Probe & MX6
1989 - On

UNIT PACKAGE: 25



21311
(01553-0038U)
Gray Nylon

Bumper Push-Type Retainer
Head Diameter: 18mm
Stem Length: 12mm
Fits Into 8mm Hole
Nissan Frontier, Pathfinder & Xterra
2005 - On

UNIT PACKAGE: 10



14698
(90688-SB0-003)
Black Nylon

Push-Type Retainer
Head Diameter: 18mm
Stem Length: 11mm
Fits Into 6mm Hole
Acura & Honda

UNIT PACKAGE: 25



17632
(Mazda: B092-51-833;
Ford: MB-455-56143)
Black Nylon

Push-Type Retainer
Head Diameter: 18mm
Stem Length: 12mm
Fits Into 8mm Hole
Mazda & Ford Aspire

UNIT PACKAGE: 10



20349
(01553-09611)
Black Nylon

Bumper Clip
Push-Type Retainer
Head Diameter: 18mm
Stem Length: 12mm
Fits Into 8mm Hole
Nissan Maxima
1994 - On

UNIT PACKAGE: 15



16784
(Nissan: 80999-05N07;
Toyota: 90467-07043)
Black Nylon

Push-Type Retainer
Head Diameter: 18mm
Stem Length: 11mm
(Not Including The Pin)
Fits Into 7mm Hole

UNIT PACKAGE: 25

**Refer To Push-Type
Retainer Specification
Chart On Pages 450 - 460**



21110
(B100-68-8550)
Black Nylon

Rear Light Access Door
Push-Type Retainer
Head Diameter: 18mm
Stem Length: 12mm
Fits Into 8.5mm Hole
Mazda 323
1986 - On

UNIT PACKAGE: 15



17081
(91524-SE0-003)
Black Nylon

Cowl Push-Type Retainer
Head Diameter: 18mm
Stem Length: 12mm
Fits Into 6mm Hole
Honda Accord
1986 - On

UNIT PACKAGE: 25



21146
(0G032-50037-A)
Black Nylon

Bumper, Fender, Grille, Interior &
Exterior Trim and Pillar
Push-Type Retainer
Head Diameter: 18mm
Stem Length: 12mm
Fits Into 8mm Hole
Kia Amanti, Magentis, Optima, Rio,
Sedona, Sephia, Sorrento, Spectra
& Sportage
2000 - On

UNIT PACKAGE: 15



20247
(Mitsubishi: MR200300)
Black Nylon

Fender & Bumper
Push-Type Retainer
Head Diameter: 18mm
Stem Length: 12mm
Fits Into 9mm Hole
Honda & Mitsubishi
1998 - On

UNIT PACKAGE: 15

Listed smallest to largest first by Head Diameter then by Stem Length and then by Hole Diameter



20365
(10301966,
10425306)
Black Nylon

Cowl Vent
Push-Type Retainer
Head Diameter: 18mm
Stem Length: 13mm
Fits Into 7.5mm Square Hole
Pontiac Aztek
2001 - On

UNIT PACKAGE: 10



17192
(91508-SM4-003)
Black Nylon

Cowl Panel Push-Type Retainer
Head Diameter: 18mm
Stem Length: 14mm
Fits Into 8mm Hole
Honda Accord
1990 - On

UNIT PACKAGE: 10



19246
(01553-09241)
Black Nylon

Bumper
Push-Type Retainer
Head Diameter: 18mm
Stem Length: 15mm
Fits Into 10mm Hole
Nissan 240SX & Maxima
1994 - On

UNIT PACKAGE: 15



21141
(91561-SJD-003)
Black & White Nylon

Pillar, Rocker Panel & Floor Retainer
Top Head Diameter: 15mm
Middle Head Diameter: 16mm
Bottom Head Diameter: 18mm
Stem Length: 13mm
Fits Into 8mm Hole
Honda Civic & Pilot
2004 - On

UNIT PACKAGE: 10



19453
(90505-SX0-003)
Black Nylon

Garnish Side Protector
Push-Type Retainer
Head Diameter: 18mm
Stem Length 15mm
(Not Including The Pin)
Fits Into 8mm Hole
Honda Odyssey
1995 - On

UNIT PACKAGE: 15



19231
(91505-SL0-003)
Black Nylon

Push-Type Retainer
Head Diameter: 18mm
Stem Length: 16mm
Fits Into 8mm Hole
Acura NSX
1991 - On

UNIT PACKAGE: 15

**Refer To Push-Type
Retainer Specification
Chart On Pages 450-460**



21225
(53888-48010)
Black Nylon

Wheel Opening
Push-Type Retainer
Head Diameter: 18mm
Stem Length: 14mm
Fits Into 7mm Hole
Toyota Highlander
2001 - On

UNIT PACKAGE: 5



19416
(Toyota: 90467-09139)
Black Nylon

Bumper Cover & Wheel Housing
Push-Type Retainer
Head Diameter: 18mm
Stem Length: 15mm
Fits Into 9mm Hole
Honda, Mazda 626 & Toyota Corolla
1992 - On

UNIT PACKAGE: 15



20988
(GM: 11589289;
Chrysler: 6508863-AA)
Black Nylon

Air Distributor &
Windshield Defroster
Push-Type Retainer
Head Diameter: 18mm
Stem Length: 17.5mm
Panel Range: 2.0mm - 4.5mm
Fits Into 6.5mm Hole
Buick Enclave, Chevrolet Equinox,
Chevrolet & GMC S & T Trucks,
GMC Acadia And Pontiac Torrent
2002 - On

UNIT PACKAGE: 25

Listed smallest to largest first by Head Diameter then by Stem Length and then by Hole Diameter



16726

(N808048S, W705532-S300)
Black Nylon

Front Bumper Stone
Deflector Retainer
Head Diameter: 18mm
Stem Length: 18mm
Fits Into 6.3mm (1/4") Square Hole
Ford Bronco, Ranger & Explorer
1989 - On

UNIT PACKAGE: 25



20545

(N811283-S)
Black Nylon &
Santoprene Rubber

Trim Panel
Push-Type Retainer
Head Diameter: 18mm
Stem Length: 18mm
Fits Into 6.3mm Hole
Ford Expedition & Navigator
1997 - On

UNIT PACKAGE: 25



21098

(Chrysler: 6508197-AA;
Ford: W706092-S300)
Black Nylon

Front Air Shield, Splash Guard &
Heat Shield
Push-Type Retainer
Head Diameter: 18mm
Stem Length: 18mm
Fits Into 6.4mm Hole
Dodge Ram 2006 - On
Ford Taurus 2008 - On

UNIT PACKAGE: 25



21089

(W710250-S300)
Black Nylon

Rear Bumper
Push-Type Retainer
Head Diameter: 18mm
Stem Length: 18mm
Fits Into 8mm Hole
Ford Edge
2007 - On

UNIT PACKAGE: 25



21123

(75867-30120)
Black Nylon

Rocker Moulding
Push-Type Retainer
Head Diameter: 18mm
Stem Length: 19mm
Fits Into 8mm Hole
Lexus GS350, GS430, GS460 &
LS460 and Toyota Camry
2007 - On

UNIT PACKAGE: 15



20367

(W706713-S300)
Black Nylon

Bumper Cover
Push-Type Retainer
Head Diameter: 18mm
Stem Length: 18mm
Fits Into 8mm Hole
Ford Escape
2001 - On

UNIT PACKAGE: 25



21672

(11611110)
Black Nylon

Cowl Vent
Push-Type Retainer
With Sealer
Head Diameter: 18mm
Stem Length: 20mm
Fits Into 6.3mm Hole
Buick Allure & LaCrosse
and Chevrolet Volt
2010 - On

UNIT PACKAGE: 15

**Refer To Push-Type
Retainer Specification
Chart On Pages 450 - 460**



19849

(Not Available From O.E.M.)
Black Nylon & Santoprene Rubber

Bumper Push-Type Retainer
Head Diameter: 18mm
Stem Length: 18mm
Fits Into 8mm Hole
Ford Taurus & Sable
2000 - On

UNIT PACKAGE: 25



20880

(11589290)
Black Nylon

Air Inlet Grille, Bumper Fascia &
Front Brake Caliper Cooling Duct
Push-Type Retainer
Head Diameter: 18mm
Stem Length: 20mm
Panel Range: 4.5mm - 7.0mm
Fits Into 6.5mm Hole
Buick Enclave, Cadillac, CTS & STS,
Chevrolet Cobalt, Equinox & SSR,
GM Trucks and Pontiac
G5 & Torrent
2002 - On

UNIT PACKAGE: 50

Listed smallest to largest first by Head Diameter then by Stem Length and then by Hole Diameter



20966
(5160260-AA)
Black Nylon

Rear Bumper, Tail Light And Fender
Push-Type Retainer
Bottom Head Diameter: 18mm
Stem Length: 20mm
Fits Into 8mm Hole
Dodge Caliber and Jeep
Compass & Patriot
2007 - On

UNIT PACKAGE: 15



20613
(63848-40Y00)
Black Nylon

Front Bumper
Push-Type Retainer
Head Diameter: 18mm
Stem Length: 20mm
Fits Into 9mm Hole
Nissan Frontier & Xterra
1998 - On

UNIT PACKAGE: 15



20888
(GM: 11561368;
Chrysler: 6508712AA)
Black Nylon

Fender, Wheel & Bumper
Push-Type Retainer
Head Diameter: 18mm
Stem Length: 20mm
Panel Range: 3.0mm - 5.8mm
Fits Into 9.5mm Hole
Chevrolet Impala & Monte Carlo and
Pontiac Grand Prix & Solstice
2004 - On
Jeep Wrangler
2000 - On

UNIT PACKAGE: 25



17057
(90505-SM4-003)
Black Nylon

Push-Type Retainer
Head Diameter: 18mm
Stem Length: 21mm
Fits Into 8mm Hole
Honda Accord
1990 - On

UNIT PACKAGE: 10



20989
(GM: 11589291;
Ford: W713331-S300)
Black Nylon

Air Dam & Grille
Push-Type Retainer
Head Diameter: 18mm
Stem Length: 22mm
Panel Range: 7.0mm - 9.5mm
Fits Into 6.5mm Hole
Cadillac CTS, SRX, and STS
2003 - On

UNIT PACKAGE: 25

**Refer To Push-Type
Retainer Specification
Chart On Pages 450 - 460**



21529
(95230842)
Black Nylon

Cowl Vent Push-Type Retainer
With Sealer
Head Diameter: 18mm
Stem Length: 22mm
Fits Into 6.5mm Hole
Chevrolet Cruze
2011 - On

UNIT PACKAGE: 15



20327
(63848-9E001)
Black Nylon

Bumper Fascia
Push-Type Retainer
Head Diameter: 18mm
Stem Length: 22mm
Fits Into 9mm Hole
Nissan Altima
1997 - On

UNIT PACKAGE: 10



14018
(N803716-S)
Black Nylon

Fascia Retainer
Head Diameter: 18mm
Stem Length: 23mm
Fits Into 7mm Hole
Ford Mustang/Capri
1985 - On

UNIT PACKAGE: 25



18939
(90467-09101)
Black Nylon

Bumper Cover
Push-Type Retainer
Head Diameter: 18mm
Stem Length: 23mm
Fits Into 9mm Hole
Lexus ES300
1993 - On

UNIT PACKAGE: 25



16622
(10157900,
11517803,
15993201)
Black Nylon

Front Bumper
Fascia Retainer
Head Diameter: 18mm
Stem Length: 23mm
Fits Into 9.5mm (3/8") Hole
Olds Cutlass 1990 - On
GM Lt. Truck
1996 - On

UNIT PACKAGE: 25

Listed smallest to largest first by Head Diameter then by Stem Length and then by Hole Diameter



20631

(11588988)
Black Nylon

Front Bumper Cover
Push-Type Retainer
Head Diameter: 18mm
Stem Length: 26mm
Fits Into 10mm Hole
Pontiac Grand Prix
2004 - On

UNIT PACKAGE: 25



19422

(6504521)
Black Nylon

Fascia
Push-Type Retainer
Head Diameter: 23/32" (18.3mm)
Stem Length: 29/32" (23mm)
Fits Into 5/16" (8mm) Hole
Chrysler LHS, Concorde, Intrepid &
Eagle Vision
1998 - On

UNIT PACKAGE: 25



21201

(90467-07211)
Black Nylon

Bumper, Radiator Cover and Grille
Push-Type Retainer
Head Diameter: 19mm
Stem Length: 8mm
Fits Into 7mm Hole
Lexus IS & LS, Scion and Toyota
Avalon, Camry & Highlander
2005 - On

UNIT PACKAGE: 10



20359

(11519444)
Black Nylon

Bumper Cover
Push-Type Retainer
Head Diameter: 18mm
Stem Length: 26mm
Fits Into 10mm Hole
Oldsmobile Intrigue,
Pontiac Aztek & Grand Prix
1997 - On

UNIT PACKAGE: 25



21479

(701-867-299)
Gray Nylon

Front Bumper & Interior Trim
Push-Type Retainer
With 3mm Allen Head Drive
Head Diameter: 18.5mm
Stem Length: 11mm
Fits Into 9mm Hole
VW Jetta & Passat
1999 - On

UNIT PACKAGE: 25



21525

(53259-0E010)
Black Nylon

Front Inner Structure
Push-Type Retainer
Head Diameter: 19mm
Stem Length: 9mm
Fits Into 7mm Hole
Lexus EX 350, IS 250, IS 350, RX
330, RX350 and RX 400H
2004 - On

UNIT PACKAGE: 15



18873

(52161-16010,
52161-02020)
Black Nylon

Rear Bumper Cover
Push-Type Retainer
Head Diameter: 18mm
Stem Length: 28mm
Fits Into 9mm Hole
Toyota Tercel
1988 - On

UNIT PACKAGE: 6

**Refer To Push-Type
Retainer Specification
Chart On Pages 450 - 460**



13469

(N802737-S)
Black Nylon

Under Hood Retainer
Head Diameter: 3/4" (19mm)
Stem Length: 1/2" (12.7mm)
Fits Into 1/4" (6.4mm) Hole
Ford Tempo & Topaz

UNIT PACKAGE: 25



20931

(52161-20010)
Black Nylon

Bumper Cover & Grille
Push-Type Retainer
Head Diameter: 18mm
Stem Length: 31mm
Fits Into 9mm Hole
Toyota
2000 - On

UNIT PACKAGE: 15



20768

(4806240AA)
Black Nylon

Rear Bumper
Push-Type Retainer
Large Head Diameter: 18.5mm
Stem Length: 21mm
Fits Into 8mm Hole
Chrysler 300 & Dodge Magnum
2005 - On

UNIT PACKAGE: 10



20826

(11609417)
Black Nylon

Fender Apron
Push-Type Retainer
Head Diameter: 19mm
Stem Length: 14mm
Panel Range: 2.7mm - 5.3mm
Fits Into 8.5mm Hole
Buick Enclave & LaCrosse, Cadillac
CTS, SRX & STS, Chevrolet Cobalt,
Equinox & Malibu, GM Trucks and
Pontiac G5, G6 & Torrent
2003 - On

UNIT PACKAGE: 50

Listed smallest to largest first by Head Diameter then by Stem Length and then by Hole Diameter



20990

(GM: 15296830;
Chrysler: 5116530-AA)
Black Nylon

Fascia & General Purpose
Push-Type Retainer
Head Diameter: 19mm
Stem Length: 16mm
Panel Range: 5.0mm - 7.0mm
Fits Into 8mm Hole
GM
2007 - On

UNIT PACKAGE: 25

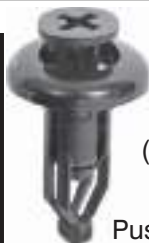

17988

(90467-09143)
Black Nylon

Push-Type Retainer
Head Diameter: 19mm
Stem Length: 26mm
Fits Into 9mm Hole
Lexus
1990 - On

UNIT PACKAGE: 10



20244

(25707329)
Green Nylon

Push-Type Retainer With Sealer
Head Diameter: 19mm
Stem Length: 32mm
Fits Into 8mm Hole
Buick LeSabre, Oldsmobile
Aurora & Pontiac Bonneville
2000 - On

UNIT PACKAGE: 10



11706

(387944-S)
Black Nylon

Grille To Metal Stamping Retainer
Head Diameter: 3/4" (19mm)
Shoulder Length: 1/4" (6.4mm)
Stem Length: 11/16" (17.5mm)
Fits Into 1/4" (6.4mm) Wide Slot
Ford Truck 1978 - On

UNIT PACKAGE: 50



19245

(5BB14LX9)
Black Nylon

Fascia To Front Bumper
Push-Type Retainer
Large Head Diameter: 3/4" (19mm)
Stem Length: 1-1/8" (28.5mm)
Fits Into 1/4" (6.4mm) Hole
Dodge Dakota
1994 - On

UNIT PACKAGE: 25



20755

(GD7A-50-EA1)
Black Nylon

Bumper Cover & Grille
Push-Type Retainer
Head Diameter: 19.5mm
Stem Length: 15mm
Fits Into 10mm Hole
Mazda
1999 - On

UNIT PACKAGE: 10

**Refer To Push-Type
Retainer Specification
Chart On Pages 450 - 460**



20273

(Ford: N808791;
Chrysler: 5GC71RC3AA,
5GF92RC3AA)
Gray Nylon

Interior Trim, Dash & Console
Push-Type Retainer
Head Diameter: 19mm
Shoulder Diameter: 10mm
Shoulder Length: 7mm
Stem Length: 22mm
Fits Into 9mm Hole
Dodge Durango & Ford Pick-Ups
1997 - On

UNIT PACKAGE: 25



18308

(3540858)
Black Nylon

Radiator Air Baffle
Push-Type Retainer
Large Head
Diameter: 3/4" (19mm)
Stem Length: 1-1/8" (28.5mm)
Fits Into 1/4" (6.4mm) Hole
Cadillac Eldorado & Seville
1993 - On

UNIT PACKAGE: 25



21568

(57160-FC000)
Black Nylon

Front Fender Push-Type Retainer
Top Head Length: 19.5mm
Bottom Head Diameter: 14mm
Stem Length: 15mm
Fits Into 10mm Hole
Subaru Forester
2008 - 1998

UNIT PACKAGE: 25

Listed smallest to largest first by Head Diameter then by Stem Length and then by Hole Diameter



20577

(GM: 88970494, 88973676; Toyota: 90467-07168)
Black Nylon

Rocker Panel & Garnish Moulding
Push-Type Retainer
Head Diameter: 20mm
Stem Length: 8mm
(Excluding The Pin)
Fits Into 7mm Hole
Pontiac Vibe 2003 - On
Lexus & Toyota
2000 - On

UNIT PACKAGE: 15



19908

(90467-07121)
Black Nylon

Door Trim Panel
Push-Type Retainer
Head Diameter: 20mm
Stem Length: 8mm
(Excluding The Pin)
Fits Into 7mm Hole
Toyota RAV4
1997 - On

UNIT PACKAGE: 10



19907

(90467-07121-B2)
Gray Nylon

Door Trim Panel
Push-Type Retainer
Head Diameter: 20mm
Stem Length: 8mm
(Excluding The Pin)
Fits Into 7mm Hole
Toyota RAV4
1997 - On

UNIT PACKAGE: 10



18888

(90467-07166)
Black Nylon

Front Fender Liner
Push-Type Retainer
Head Diameter: 20mm
Stem Length: 8mm
(Excluding The Pin)
Fits Into 7mm Hole
Toyota Tercel
1994 - On

UNIT PACKAGE: 15

**Refer To Push-Type
Retainer Specification
Chart On Pages 450 - 460**



21631

(84995-35101)
Black Nylon

Push-Type Retainer
Head Diameter: 20mm
Stem Length: 8mm
(Excluding The Pin)
Fits Into 8mm Hole
Nissan Sentra
2007 - On

UNIT PACKAGE: 15



19905

(01553-10051)
Black Nylon

Push-Type Retainer
Head Diameter: 20mm
Stem Length: 8mm
(Excluding The Pin)
Fits Into 8mm Hole
Nissan Maxima
1999 - On

UNIT PACKAGE: 15



14369

(1395-68-676, 9926-50-635)
Black Nylon

Push-Type Retainer
Head Diameter: 20mm
Stem Length: 9mm
Fits Into 6mm Hole
Mazda

UNIT PACKAGE: 15



19128

(90467-07044)
Black Nylon

Quarter Panel
Wheel Opening Moulding
Push-Type Retainer
Head Diameter: 20mm
Stem Length: 9mm
Fits Into 7mm Hole
Toyota T-100
1992 - On

UNIT PACKAGE: 10



21294

(90467-07214)
Black Nylon

Radiator Splash Shield
Push-Type Retainer
Head Diameter: 20mm
Stem Length: 9mm
Fits Into 7mm Hole
Toyota Camry
2007 - On

UNIT PACKAGE: 25



20270

(51-48-1-938-725)
Black Nylon

Hood & Trunk Insulation
Push-Type Retainer
Head Diameter: 20mm
Stem Length: 9mm
Fits Into 7mm Hole
BMW Series 3, 5, & 7
2001 - 84

UNIT PACKAGE: 25

Listed smallest to largest first by Head Diameter then by Stem Length and then by Hole Diameter



21422
(90914-0051)
Black Nylon

Front Bumper & Quarter Panel
Push-Type Retainer
Head Diameter: 20mm
Stem Length: 9mm
(Excluding The Pin)
Fits Into 7mm Hole
Subaru Impreza, Legacy,
Outback & Tribeca
2005 - On

UNIT PACKAGE: 15



16000
(Honda: 90675-SB3-003;
Mazda: FB01-56-964;
Nissan: 63876-95596)
Black Nylon

Push-Type Retainer
Head Diameter: 20mm
Stem Length: 9mm
Fits Into 8mm Hole
Honda, Mazda & Nissan

UNIT PACKAGE: 25



19315
(BC1D-56-145)
Black Nylon

Mud Guard Push-Type Retainer
Head Diameter: 20mm
Stem Length: 9mm
(Excluding The Pin)
Fits Into 8mm Hole
Mazda Protege
1996 - On

UNIT PACKAGE: 15



17379
(91512-SM4-003)
Black Nylon

Fender Splash Shield
Push-Type Retainer
Head Diameter: 20mm
Stem Length: 9mm
Fits Into 8mm Hole
Honda Accord
1990 - On

UNIT PACKAGE: 10



20637
(123-990-02-92)
Black Nylon

Push-Type Retainer
Head Diameter: 20mm
Stem Length: 9mm
Fits Into 8mm Hole
Mercedes-Benz

UNIT PACKAGE: 10

**Refer To Push-Type
Retainer Specification
Chart On Pages 450 - 460**



19274
(01553-09321)
Black Nylon

Push-Type Retainer
Head Diameter: 20mm
Stem Length: 9mm
(Not Including The Pin)
Fits Into 8mm Hole
Nissan Maxima & 300ZX
1994 - On

UNIT PACKAGE: 15



21010
(90467-09166)
Black Nylon

Push-Type Retainer
Head Diameter: 20mm
Stem Length: 9mm
Fits Into 9mm Square Hole
Toyota Camry
2006 - On

UNIT PACKAGE: 15



20908
(90467-07164)
Black Nylon

Fender Splash Shield
Push-Type Retainer
Head Diameter: 20mm
Stem Length: 10mm
Fits Into 7mm Hole
Toyota Camry, Echo, MR2 & Sienna
1997 - On

UNIT PACKAGE: 10



21571
(59122-FA010)
Black Nylon

Front Bumper, Fender, Windshield
Washer & Rocker Moulding
Push-Type Retainer
Head Diameter: 20mm
Stem Length: 10mm
Fits Into 8mm Hole
Subaru B9 Tribeca, Baja, Forester,
Impreza, Legacy & Outback
1998 - On

UNIT PACKAGE: 25

Listed smallest to largest first by Head Diameter then by Stem Length and then by Hole Diameter



19118

(91501-S04-003)

Black Nylon

Front Fender
Push-Type Retainer
Head Diameter: 20mm
Stem Length: 10mm
Fits Into 8mm Hole
Honda Civic & Del Sol
1993 - On

UNIT PACKAGE: 15



21594

(90913-0051)

Black Nylon

Fender Liner, Duct
& Lower Moulding
Push-Type Retainer
Head Diameter: 20mm
Stem Length: 11mm
Fits Into 7mm Hole
Subaru B9 Tribeca, Forester,
Impreza, Legacy & Outback
2005 - On

UNIT PACKAGE: 15



17347

(01553-06721)

Black Nylon

Front & Rear Bumper
Cover Push-Type Retainer
Head Diameter: 20mm
Stem Length: 11mm
(Excluding The Pin)
Fits Into 8mm Hole
Nissan Maxima & Infiniti
1990 - On

UNIT PACKAGE: 15



21651

(91501-TR0-003)

Black Nylon

Fender Push-Type Retainer
Head Diameter: 20mm
Stem Length: 10mm
Fits Into 8mm Hole
Honda Civic
2012 - On

UNIT PACKAGE: 25



21592

(90914-0052)

Black Nylon

Push-Type Retainer
Head Diameter: 20mm
Stem Length: 11mm
Fits Into 7mm Hole
Subaru B9 Tribeca,
Impreza, Legacy & Outback
2005 - On

UNIT PACKAGE: 15



21297

(91503-S7A-003)

Black Nylon

Front Bumper Push-Type Retainer
Head Diameter: 20mm
Stem Length: 11mm
Fits Into 10mm Hole
Honda Civic
2010 - On

UNIT PACKAGE: 15

**Refer To Push-Type
Retainer Specification
Chart On Pages 450 - 460**



17992

(90467-07138)

Black Nylon

Push-Type Retainer
Head Diameter: 20mm
Stem Length: 12mm
Fits Into 7mm Hole
Lexus 1990 - On

UNIT PACKAGE: 10



21086

(203-990-01-92)

Black Nylon

Hood Insulation
Push-Type Retainer
Head Diameter: 20mm
Stem Length: 10mm
Fits Into 8mm Hole
Mercedes-Benz GL, M, R, SL & SLK
2005 - On

UNIT PACKAGE: 15



19239

(Honda: 91512-SX0-003;

Mitsubishi: MU000319)

Black Nylon

Front Fender & Bumper Support
Push-Type Retainer
Head Diameter: 20mm
Stem Length: 11mm
Fits Into 8mm Hole
Acura 3.5RL, Honda Accord,
Prelude & Odyssey
1994 - On

Mitsubishi Lancer
2002 - On

UNIT PACKAGE: 25



21580

(59122-AC030)

Black Nylon

Front Fender Push-Type Retainer
Head Diameter: 20mm
Stem Length: 12mm
Fits Into 7mm Hole
Subaru B9 Tribeca, Baja, Forester
Legacy & Outback
1995 - On

UNIT PACKAGE: 25

Listed smallest to largest first by Head Diameter then by Stem Length and then by Hole Diameter



21500

(90914-0063)
Black Nylon

Cowl Vent
Push-Type Retainer
Head Diameter: 20mm
Stem Length: 12mm
Fits Into 7mm Hole
Subaru Legacy & Outback
2010 - On

UNIT PACKAGE: 10



21192

(01553-05323)
Black Nylon

Cowl, Bumper & Fender Liner
Push-Type Retainer
Head Diameter: 20mm
Stem Length: 12mm
Fits Into 8mm Hole
Infiniti FX35, FX45, G35 and Nissan
2003 - On

UNIT PACKAGE: 10



20953

(11296-AG000)
Black Nylon

Front Bumper And
Radiator Support
Push-Type Retainer
Head Diameter: 20mm
Stem Length: 13mm
Fits Into 8mm Hole
Infiniti FX 35/45 and
Nissan Altima, Maxima
& Quest
2002 - On

UNIT PACKAGE: 25



20516

(W706182-S300)
Black Nylon

Headlight Mounting & Deck Lid
Push-Type Retainer
Head Diameter: 20mm
10mm Hex
Stem Length: 13mm
Fits Into 8mm Hole
Ford Expedition, Explorer & Focus
2000 - On

UNIT PACKAGE: 25



20986

(91505-S9A-003)
Black Nylon

Front Bumper
Push-Type Retainer
With Internal Metal Insert
Head Diameter: 20mm
Stem Length: 13mm
Fits Into 10mm Hole
Honda Civic
2006 - On

UNIT PACKAGE: 10



19233

(91503-SZ3-003)
Black Nylon

Front Bumper Push-Type Retainer
Head Diameter: 20mm
Stem Length: 13mm
Fits Into 10mm Hole
Acura 3.5RL Sedan & Honda
1996 - On

UNIT PACKAGE: 15

**Refer To Push-Type
Retainer Specification
Chart On Pages 450 - 460**



21454

(91503-SHJ-A01)
Black Nylon

Front Bumper
Push-Type Retainer
Head Diameter: 20mm
Stem Length: 13mm
Fits Into 10mm Hole
Honda Odyssey
2010 - 05

UNIT PACKAGE: 10



16782

(Honda:
91545-SE0-0030-W1;
Nissan: 63848-01G00)
Black Nylon

Push-Type Retainer
Head Diameter: 20mm
Stem Length: 8mm
(Excluding The Pin)
Fits Into 8mm Hole

UNIT PACKAGE: 25



21134

(01553-09431)
Black Nylon

Front Bumper
Push-Type Retainer
Head Diameter: 20mm
Stem Length: 11mm
(Excluding The Pin)
Fits Into 8mm Hole
Nissan Maxima
2004 - On

UNIT PACKAGE: 15



20638

(201-990-02-92)
Black Nylon

Push-Type Retainer
Head Diameter: 20mm
Stem Length: 14mm
Fits Into 8.5mm Hole
Mercedes-Benz

UNIT PACKAGE: 25

Listed smallest to largest first by Head Diameter then by Stem Length and then by Hole Diameter



20608

(91503-S0K-A01)
Black Nylon

Grille Mounting
Push-Type Retainer
Head Diameter: 20mm
Stem Length: 14mm
Fits Into 10mm Hole
Honda Element
2003 - On

UNIT PACKAGE: 15



17350

(91516-SK7-013)
Black Nylon

Splash Shield
Push-Type Retainer
Phillips Drive
Head Diameter: 20mm
Stem Length: 15mm
Fits Into 8mm Hole
10mm Hex
Honda Civic
1992 - On

UNIT PACKAGE: 10



20388

(51218-205-295)
Black Nylon

Cowl Vent
Push-Type Retainer
Head Diameter: 20mm
Stem Length: 16mm
Fits Into 7mm Hole
Use With Auveco 20254
BMW Series 5
1997 - On

UNIT PACKAGE: 50



20734

(51-11-1-944-537)
Black Nylon

Bumper, Wheel Opening,
Scuff Plate & Interior Trim
Push-Type Retainer
Head Diameter: 20mm
Stem Length: 15mm
Fits Into 6.3mm Hole
BMW Series 3, 5, 7 & X5
1989 - On

UNIT PACKAGE: 50



17267

(91503-SP0-003)
Black Nylon

Front & Rear Bumper
Push-Type Retainer
Head Diameter: 20mm
Stem Length: 15mm
Fits Into 10mm Hole
Acura Legend
1991 - On

UNIT PACKAGE: 15



21596

(75867-06030)
Black Nylon

Rocker Panel Push-Type Retainer
Head Diameter: 20mm
Stem Length: 16mm
Fits Into 8mm Hole
Toyota & Lexus
2007 - On

UNIT PACKAGE: 25



21545

(01553-08231)
Black Nylon

Front & Rear Bumper and Grille
Push-Type Retainer
Head Diameter: 20mm
Stem Length: 15mm
Fits Into 8mm Hole
Infiniti FX35, FX45 & Q45 and
Nissan Murano, 240 SX & 350Z
1995 - On

UNIT PACKAGE: 25



21563

(90913-0059)
Black Nylon

Front Bumper & Fender
Push-Type Retainer
Head Diameter: 20mm
Stem Length: 15mm
Fits Into 10mm Hole
Subaru Forester, Impreza & Outback
2006 - 02

UNIT PACKAGE: 25

**Refer To Push-Type
Retainer Specification
Chart On Pages 450 - 460**



21173

(91506-S9A-003)
Black Nylon

Bumper & Splash Shield
Push-Type Retainer
With Metal Insert
Head Diameter: 20mm
Stem Length: 16mm
Fits Into 10mm Hole
Acura MDX, RDX & TSX and Honda
Accord, Civic CR-V & Fit
2009 - 04

UNIT PACKAGE: 10

Listed smallest to largest first by Head Diameter then by Stem Length and then by Hole Diameter



20766
(6507669-AA)
Black Nylon

Radiator Grille
Push-Type Retainer
Head Diameter: 20mm
Stem Length: 16mm
Fits Into 10mm Hole
Dodge Durango
2004 - On

UNIT PACKAGE: 25



20248
(51-11-8-174-185)
Black Nylon

Bumper Trim
Push-Type Retainer
Head Diameter: 20mm
Stem Length: 17mm
Fits Into 6.3mm Hole
BMW Series 3, 5 & 7
1995 - On

UNIT PACKAGE: 25



20458
(6506132-AA)
Black Nylon

Side Radiator Shield
Push-Type Retainer
Head Diameter: 20mm
Stem Length: 17mm
Fits Into 7mm Hole
Chrysler Sebring & Stratus
2001 - On

UNIT PACKAGE: 25



16858
(Nissan: 63844-01A00; Kia:
MNA01-56-145; Mazda:
NA01-56-145; Ford: MNA01-56145,
NA01-56145)
Black Nylon

Inner Fender Push-Type Retainer
Head Diameter: 20mm (25/32")
Stem Length: 18mm (23/32")
Fits Into 8mm (5/16") Hole
Nissan 1980 - On
Mazda, Kia & Ford

UNIT PACKAGE: 25



20564
(91503-SZ5-003)
Black Nylon

Front & Rear Bumper
Push-Type Retainer
Head Diameter: 20mm
Stem Length: 18mm
Fits Into 10mm Hole
Acura 3.5RL And
Honda Accord & Odyssey
1996 - On

UNIT PACKAGE: 15



21119
(B100-68-675-69)
Black Nylon

Push-Type Retainer
Head Diameter: 20mm
Stem Length: 19mm
Fits Into 6mm Hole
Ford Probe And Mazda MX6
1988 - On

UNIT PACKAGE: 15

**Refer To Push-Type
Retainer Specification
Chart On Pages 450 - 460**



17472
(Mitsubishi: MB547806;
Nissan: 63854-01A00)
Black Nylon

Front Bumper Fascia
Push-Type Retainer
Head Diameter: 20mm
Stem Length: 20mm
Fits Into 8mm Hole
Mitsubishi & Nissan 300ZX
1990 - On

UNIT PACKAGE: 15



17216
(GM: 21030249;
Ford: N807389S;
Chrysler: 6503598)
Black Nylon

Air Baffle To Under Carriage
Push-Type Retainer
Head Diameter: 20mm
Stem Length: 20mm
Fits Into 8mm Hole
GM Saturn
2 Door & 4 Door
Models
1991 - On
Ford & Chrysler

UNIT PACKAGE: 25



20991
(11589292)
Black Nylon

Bumper Fascia, Flares & Air Dam
Push-Type Retainer
Head Diameter: 20mm
Stem Length: 20mm
Panel Range: 2.0mm - 4.5mm
Fits Into 8.5mm Hole
Chevrolet And GMC C & K Trucks
2007 - On

UNIT PACKAGE: 25

Listed smallest to largest first by Head Diameter then by Stem Length and then by Hole Diameter



16625
(10108746)
Black Nylon

Front Bumper Fascia Retainer
Head Diameter: 20mm
Stem Length: 20mm
Fits Into 10mm Square Hole
GM Station Wagons
1991 - On

UNIT PACKAGE: 25



20348
(63878-01E10)
Black Nylon

Push-Type Retainer
Head Diameter: 20mm
Stem Length: 22mm
Fits Into 8mm Hole
Nissan Maxima
1994 - On

UNIT PACKAGE: 15



17144
(91504-SM4-000)
Black Nylon

Bumper Fascia
Push-Type Retainer
Head Diameter: 20mm
Stem Length: 24mm
Fits Into 10mm Hole
Honda Accord
1990 - On

UNIT PACKAGE: 10



19140
(Acura: 90505-SL0-003;
GM: 94852368;
Mitsubishi: MB888869;
Toyota: 90467-08155)
Black Nylon

Push-Type Retainer
Head Diameter: 20mm
Stem Length: 21mm
Fits Into 8mm Hole
Acura, Dodge Avenger, Eagle Talon,
Geo Prizm, Mitsubishi Eclipse &
Galant and Toyota
1993 - On

UNIT PACKAGE: 5



20889
(GM: 11589293;
Ford: W712196-S300)
Black Nylon

Cowl Vent & Fender
Push-Type Retainer
Head Diameter: 20mm
Stem Length: 22mm
Panel Range: 4.5mm - 7.0mm
Fits Into 8.5mm Hole
Buick Century, LaCrosse & Regal,
Cadillac, Chevrolet Equinox, GM
Trucks, Hummer H3 and Pontiac
Grand Prix & Torrent
1997 - On

Ford 2006 - On

UNIT PACKAGE: 25



18119
(91502-SP0-003)
Black Nylon

Front & Rear Bumper
Push-Type Retainer
Head Diameter: 20mm
Stem Length: 25mm
Fits Into 10mm Hole
Honda
1990 - On

UNIT PACKAGE: 10

**Refer To Push-Type
Retainer Specification
Chart On Pages 450 - 460**



19615
(15153415)
Black Nylon

Rear Bumper Cover
Push-Type Retainer
Large Head Diameter: 20mm
Stem Length: 21mm
Fits Into 9mm Hole
GM C & K Trucks
1999 - On

UNIT PACKAGE: 25



20992
(11589294)
Black Nylon

Bumper Fascia, Fender And
Toe/Floor Panel
Push-Type Retainer
Head Diameter: 20mm
Stem Length: 24mm
Panel Range: 7.0mm - 10.0mm
Fits Into 8.5mm Hole
Buick Enclave & LaCrosse,
Chevrolet & GMC C & K Trucks,
GMC Acadia, Hummer H3 and
Saturn Outlook
2005 - On

UNIT PACKAGE: 25



18951
(MR-138807)
Black Nylon

Front Bumper & Support
Push-Type Retainer
Head Diameter: 20mm
Stem Length: 26mm
Fits Into 8mm Hole
Mitsubishi Eclipse
1994 - On

UNIT PACKAGE: 5

Listed smallest to largest first by Head Diameter then by Stem Length and then by Hole Diameter



20632

(GM: 11518017;
Ford: W708530-S300)
Black Nylon

Bumper Cover & Fender Shield
Push-Type Retainer
Head Diameter: 20mm
Stem Length: 26mm
Fits Into 8mm Hole
GM & Ford
1997 - On

UNIT PACKAGE: 15



19739

(90467-09127)
Black Nylon

Bumper Cover
Push-Type Retainer
Head Diameter: 20mm
Stem Length: 26mm
Fits Into 9mm Hole
Toyota Avalon, Camry,
Corolla & Solara
1998 - On

UNIT PACKAGE: 10



17143

(91502-SM4-000)
Black Nylon

Bumper Fascia Push-Type Retainer
Head Diameter: 20mm
Stem Length: 27mm
Fits Into 10mm Hole
Honda Accord
1990 - On

UNIT PACKAGE: 10

19407

Same As 17143
Except For Packing

UNIT PACKAGE: 50



18896

(21095797)
Black Nylon

Bumper Fascia
Push-Type Retainer
Head Diameter: 20mm
Stem Length: 28mm
Fits Into 8mm Hole
GM Saturn
1996 - On

UNIT PACKAGE: 25



20337

(24576759)
Black Nylon

Radiator Air Baffle &
General Purpose
Push-Type Retainer
Head Diameter: 20mm
Stem Length: 39mm
Fits Into 6mm Hole
Chevrolet Malibu, Oldsmobile Alero
& Cutlass And Pontiac Grand Am
1999 - On

UNIT PACKAGE: 15

Refer To Push-Type

Retainer Specification

Chart On Pages 450 - 460



21420

(90914-0007)
Black Nylon

Bumper, Engine Cover, Fender &
Grille Push-Type Retainer
Head Diameter: 21mm
Stem Length: 15mm
(Excluding The Pin)
Fits Into 10mm Hole
Subaru Baja, Forester, Impreza,
Legacy, Outback & Tribeca
2000 - On

UNIT PACKAGE: 15



20457

(4857345-AA)
Black Nylon

Tail Light Housing
Push-Type Retainer
Large Head Diameter: 21mm
Stem Length: 23mm
Fits Into 9.5mm Hole
Chrysler Caravan, Town & Country
And Voyager Mini Vans
2002 - On

UNIT PACKAGE: 25



16835

(GM: 10140480;
Chrysler: 6502625)
Black Nylon

Rear Bumper Fascia Retainer
Head Diameter: 21mm (27/32")
Shoulder Length: 3mm (1/8")
Stem Length: 25mm (1")
Fits Into 12mm (1/2") Hole
GM APV Vans
1990 - On

UNIT PACKAGE: 25



14998

(15672330. 15956470)
Black Nylon

Push-Type Retainer
Head Diameter: 27/32" (21.4mm)
Stem Length: 1" (25.4mm)
Fits Into 13/32" (10.3mm) Hole
GM
1987 - On

UNIT PACKAGE: 25

Listed smallest to largest first by Head Diameter then by Stem Length and then by Hole Diameter



20739
(WX68DX9-AA)
Black Nylon

Door Trim Panel
Push-Type Retainer
Head Diameter: 22mm
Stem Length: 10mm
(Excluding The Pin)
Fits Into 9mm Hole
Chrysler 300 & Dodge Magnum
2005 - On

UNIT PACKAGE: 25



20948
(0WX68BD1-AA)
Tan Nylon

Door Trim Panel
Push-Type Retainer
Head Diameter: 22mm
Stem Length: 10mm
(Excluding The Pin)
Fits Into 9mm Hole
Chrysler 300M, Charger & Magnum
2005 - On

UNIT PACKAGE: 25



21366
(90467-09227)
Black Nylon

Bumper & Engine Under Cover
Push-Type Retainer
Head Diameter: 22mm
Stem Length: 15mm
(Excluding The Pin)
Fits Into 9mm Hole
Toyota 4 Runner, RAV 4 & Scion XB
2006 - On

UNIT PACKAGE: 10



21021
(0WX68BD5-AA)
Dark Gray Nylon

Door Trim Panel
Push-Type Retainer
Head Diameter: 22mm
Stem Length: 10mm
(Excluding The Pin)
Fits Into 9mm Hole
Chrysler Charger, Magnum & 300M
2005 - On

UNIT PACKAGE: 25



20863
(5480772)
Black Nylon

Lower Rocker Moulding
Push-Type Retainer
Head Diameter: 22mm
Stem Length: 13mm
(Excluding The Pin)
Fits Into 15mm Hole
Chevrolet Equinox
2005 - On

UNIT PACKAGE: 10

**Refer To Push-Type
Retainer Specification
Chart On Pages 450 - 460**



20967
(Not Available From O.E.M.)
Black Nylon

Rear Bumper Mounting Bracket
Push-Type Retainer
Head Diameter: 22mm
Stem Length: 16mm
Fits Into 10mm Hole
Jeep Commander
2006 - On

UNIT PACKAGE: 15



21427
(0WX68XDB-AA)
Light Gray Nylon

Door Trim Panel
Push-Type Retainer
Head Diameter: 22mm
Stem Length: 10mm
(Excluding The Pin)
Fits Into 9mm Hole
Chrysler 300M, Charger & Magnum
2005 - On

UNIT PACKAGE: 25



17378
(01553-03101)
Black Nylon

Bumper & Fascia
Push-Type Retainer
Head Diameter: 22mm
Stem Length: 14mm
(Excluding The Pin)
Fits Into 11mm Hole
Nissan
1986 - On

UNIT PACKAGE: 15



19847
(5973823)
Blue Nylon

Fascia Retainer
Head Diameter: 7/8" (22mm)
Shoulder Length: 5/32" (4mm)
Stem Length: 25/32" (20mm)
Fits Into 1/2" (12.7mm) Hole
GM
1979 - On

UNIT PACKAGE: 25

Listed smallest to largest first by Head Diameter then by Stem Length and then by Hole Diameter



20753
(01553-03201)
Black Nylon

Front & Rear Bumper
Push-Type Retainer
Head Diameter: 22mm
Stem Length: 21mm
Fits Into 8mm Hole
Nissan
1982 - On

UNIT PACKAGE: 10



21578
(57750-AA090)
Black Nylon

Front & Rear Bumper
Push-Type Retainer
Head Diameter: 22mm
Stem Length: 28mm
Fits Into 10mm Hole
Subaru Impreza & Legacy
2001 - 1993

UNIT PACKAGE: 25



21452
(1H0-819-055-C01C)
Black Nylon

Push-Type Retainer
Top Head Diameter: 23mm
Bottom Head Diameter: 16mm
Stem Length: 15mm
Fits Into 8mm x 8mm Square Hole
VW
2002 - 1993

UNIT PACKAGE: 25



18269
(6503106)
Black Nylon

Lower Sill Moulding
Push-Type Retainer
Large Head Diameter: 7/8" (22mm)
Stem Length: 1" (25.4mm)
Fits Into 1/4" (6.4mm) Hole
Jeep Grand Cherokee Laredo
1994 - On

UNIT PACKAGE: 15



21251
(6Q0-868-243)
Black & White Nylon

Trim Panel
Push-Type Retainer With Sealer
Head Diameter: 22.5mm
Stem Length: 8mm
(Excluding The Pin)
Fits Into 8mm Hole
Volkswagen Golf, Jetta, Passat,
Phaeton, Rabbit & Tiguan
2004 - On

UNIT PACKAGE: 15



20767
(4806110-AA)
Black & White Nylon

Front Bumper
Push-Type Retainer
Head Diameter: 24mm
Shoulder Length: 3mm
Stem Length: 20mm
Fits Into 11mm Hole
Chrysler 300 & Dodge Magnum
2005 - On

UNIT PACKAGE: 15

**Refer To Push-Type
Retainer Specification
Chart On Pages 450 - 460**



15043
(14103461)
Black Nylon

Bumper Fascia Retainer
Head Diameter: 7/8" (22mm)
Shoulder Length: 5/32" (4mm)
Stem Length: 1-3/64" (26.5mm)
Fits Into 1/2" (12.7mm) Hole
GM
1987 - On

UNIT PACKAGE: 25



21482
(1H0-867-199-A)
Black Nylon

Push-Type Retainer
Head Diameter: 24mm
Stem Length: 13mm
Fits Into 9mm Square Hole
VW Passat
1999 - 90

UNIT PACKAGE: 25



21376
(4389947-AA)
Black and White Nylon

Bumper Cover
Push-Type Retainer With Sealer
Head Diameter: 24mm
Shoulder Length: 3mm
Stem Length: 20mm
Fits Into 11mm Hole
Chrysler Avenger, Journey &
Sebring
2008 - On

UNIT PACKAGE: 10

Listed smallest to largest first by Head Diameter then by Stem Length and then by Hole Diameter



21176
(10382313)
Black Nylon

Sight Shield & Trim
Push-Type Retainer
Head Diameter: 24.5mm
Stem Length: 13mm
(Excluding The Pin)
Fits Into 9mm Hole
Cadillac STS, Pontiac Solstice
and Saturn Sky
2005 - On

UNIT PACKAGE: 10



20233
(W705956-S300)
Black Nylon

Cowl Push-Type Retainer
Head Diameter: 25mm
Shoulder Diameter: 10mm
Shoulder Length: 3mm
Stem Length: 12mm
(Excluding The Pin)
Fits Into 9mm Hole
Lincoln LS
1999 - On

UNIT PACKAGE: 15



20993
(GM: 11589295; Ford:
W712665-S300)
Black Nylon

Fender, Flare, Gas Tank &
Panel Attachment
Push-Type Retainer
Head Diameter: 25mm
Stem Length: 20mm
Panel Range: 3.0mm - 6.0mm
Fits Into 10.5mm Hole
Chevrolet Cobalt & HHR, GM C & K
Trucks and Pontiac G5
2005 - On

UNIT PACKAGE: 25



20518
(W705957-S300,
W706519-S300)
Black Nylon

Radiator Sight Shield
Push-Type Retainer
Head Diameter: 24.5mm
Stem Length: 14mm
Fits Into 9mm Hole
Lincoln LS
2000 - On

UNIT PACKAGE: 10



21501
(90914-0055)
Black Nylon

Push-Type Retainer With Sealer
Head Diameter: 25mm
Shoulder Length: 3mm
Shoulder Diameter: 16.5mm
Stem Length: 16mm
(Excluding The Pin)
Fits Into 11mm Hole
Subaru 2006 - On

UNIT PACKAGE: 5



20994
(11589296)
Black Nylon

Panel Attachment
& General Purpose
Push-Type Retainer
Head Diameter: 25mm
Stem Length: 23mm
Panel Range: 6.0mm - 9.00mm
Fits Into 10.5mm Hole
Buick Enclave and GMC Acadia
2007 - On

UNIT PACKAGE: 25

**Refer To Push-Type
Retainer Specification
Chart On Pages 450 - 460**



21400
(10426555)
Natural Nylon

Front Bumper
Push-Type Retainer
Top Head
Diameter: 24.5mm
Bottom Head
Diameter: 23.5mm
Stem Length: 36mm
Fits Into 10mm Hole
Buick Allure & LaCrosse Chevrolet
Impala & Monte Carlo and
Pontiac Grand Prix
2000 - On

UNIT PACKAGE: 15



21576
(90914-0002)
Black Nylon

Rocker, Pillar, Floor & Exterior Trim
Push-Type Retainer With Sealer
Head Diameter: 25mm
Shoulder Diameter: 17mm
Shoulder Length: 3mm
Stem Length: 16mm
(Excluding The Pin)
Fits Into 11mm Hole
Subaru B9 Tribeca, Baja, Legacy &
Outback 2000 - On

UNIT PACKAGE: 25



15701
(N804674-S)
Black Nylon

Push-Type Retainer
Head Diameter: 25mm
Stem Length: 27mm
Fits Into 7mm Hole
Ford Mustang & Capri

UNIT PACKAGE: 50

Listed smallest to largest first by Head Diameter then by Stem Length and then by Hole Diameter



21361

(GM: 11561874;
Nissan: 622A2-9E000A)
Black Nylon

Bumper Cover
Push-Type Retainer
Head Diameter: 25mm
Stem Length: 29mm
Fits Into 7mm Hole
Chevrolet Malibu 2008 - On
Saturn Aura 2007 - On
Pontiac G6 2010 - On
Nissan Altima 1997 - On

UNIT PACKAGE: 15



19244

(N808847-S)
Black Nylon

Trunk Trim Panel
Push-Type Retainer
Head Diameter: 1" (25.4mm)
Stem Length: 11/16" (17.5mm)
Fits Into 1/4" (6.4mm) Square Hole
Ford Taurus & Sable
1996 - On

UNIT PACKAGE: 25



14010

(14045480)
Black Nylon

Fascia Retainer
Head Diameter: 1" (25.4mm)
Stem Length: 23/32" (18.3mm)
Fits Into 3/8" (9.5mm) Hole
GM 1982 - On

UNIT PACKAGE: 25



12757

(5973400)
Black Nylon

Fascia Retainer
Head Diameter: 1" (25.4mm)
Shoulder Length: 1/8" (3.2mm)
Stem Length: 3/4" (19mm)
Fits Into 1/2" (12.7mm) Hole
GM 1979 - On

UNIT PACKAGE: 15

16265

Same as 12757 except packing

UNIT PACKAGE: 50



14147

(20547865)
Black Nylon

Body Retainer
Head Diameter: 1" (25.4mm)
Stem Length: 7/8" (22mm)
Fits Into 1/4" (6.4mm) Hole
GM 1984 - On

UNIT PACKAGE: 25

**Refer To Push-Type
Retainer Specification
Chart On Pages 450 - 460**



14020

(Ford: N802781-S;
GM: 14093088)
Black Nylon

Splash Shield &
Fascia Retainer
Head Diameter:
1" (25.4mm)
Stem Length: 7/8" (22mm)
Fits Into 1/4" (6.4mm) Hole
GM & Ford

UNIT PACKAGE: 25



14019

(Ford: N803421-S,
Chrysler: 6501590)
Black Nylon

Splash Shield &
Fascia Retainer
Head Diameter: 1" (25.4mm)
Shoulder Length: 1/8" (3.2mm)
Stem Length: 7/8" (22mm)
Fits Into 5/16" (8mm) Hole
Ford & Chrysler

UNIT PACKAGE: 25



13994

(GM: 20570245,
20635065;
Ford: N804614S)
Black Nylon

Splash Shield, Seat Cushion &
Spare Tire Retainer
Head Diameter: 1" (25.4mm)
Stem Length: 7/8" (22mm)
Fits Into 5/16" (8mm) Hole
GM 1984 - On
Ford

UNIT PACKAGE: 25



12756

(5973996)
Brown Nylon

Fascia Retainer
Head Diameter: 1" (25.4mm)
Shoulder Length: 1/4" (6.4mm)
Stem Length: 7/8" (22mm)
Fits Into 1/2" (12.7mm) Hole
GM 1982 - On

UNIT PACKAGE: 15

Listed smallest to largest first by Head Diameter then by Stem Length and then by Hole Diameter



14994
(N804837S)
Black Nylon

Push-Type Retainer
Head Diameter: 1" (25.4mm)
Stem Length: 29/32" (23mm)
Fits Into 1/4" (6.4mm) Hole
Ford 1987 - On

UNIT PACKAGE: 50



20265
(25663903)
Black Nylon

Radiator Support Sight Shield
Push-Type Retainer
Head Diameter: 1" (25.4mm)
Stem Length: 1" (25.4mm)
Fits Into 1/4" (6.4mm) Hole
Cadillac DeVille & Seville
1998 - On

UNIT PACKAGE: 10



15045
(10053388, 22542705)
Black Nylon

Bumper Fascia Retainer
Head Diameter: 1" (25.4mm)
Shoulder Length: 1/8" (3.2mm)
Stem Length: 1-7/64" (28.2mm)
Fits Into 1/2" (12.7mm) Hole
GM 1987 - On

UNIT PACKAGE: 25



18310
(22587036)
Black Nylon

Rear Bumper Fascia
Push-Type Retainer
Head Diameter: 1" (25.4mm)
Stem Length: 15/16" (24mm)
Fits Into 3/8" (9.5mm) Hole
Chevrolet Cavalier & Pontiac Sunfire
1995 - On

UNIT PACKAGE: 25



18503
(W701054-S300)
Black Nylon

Front Bumper
Push-Type Retainer
Head Diameter: 1" (25.4mm)
Stem Length: 1" (25.4mm)
Fits Into 5/16" (8mm) Hole
Ford Contour & Mystique
1995 - On

UNIT PACKAGE: 25



18394
(6503453)
Black Nylon

Bumper Fascia Retainer
Head Diameter: 1" (25.4mm)
Stem Length: 1-1/8" (28.5mm)
Fits Into 1/4" (6.4mm) Hole
Jeep Grand Cherokee
1994 - On

UNIT PACKAGE: 25

**Refer To Push-Type
Retainer Specification
Chart On Pages 450 - 460**



15702
(14101262)
Black Nylon

Plastic Cover On Engine
Compartment Retainer
Head Diameter: 1" (25.4mm)
Shoulder Length: 1/8" (3.2mm)
Stem Length: 15/16" (24mm)
Fits Into 1/2" (12.7mm) Hole
Buick, Oldsmobile & Pontiac
1988 - On

UNIT PACKAGE: 25



15044
(22535007)
Black Nylon

Bumper Fascia Retainer
Head Diameter: 1" (25.4mm)
Shoulder Length: 1/8" (3.2mm)
Stem Length: 1" (25.4mm)
Fits Into 1/2" (12.7mm) Hole
GM 1987 - On

UNIT PACKAGE: 25



15042
(10077283)
Black Nylon

Bumper Fascia Retainer
Head Diameter: 1" (25.4mm)
Shoulder Length: 1/4" (6.4mm)
Stem Length: 1-1/8" (28.5mm)
Fits Into 1/2" (12.7mm) Hole
GM 1982 - On

UNIT PACKAGE: 25

PUSH-TYPE RETAINERS

Sec. 19

Listed smallest to largest first by Head Diameter then by Stem Length and then by Hole Diameter



18268
(15959832)
Black Nylon

Front License
Plate Bracket
Push-Type Retainer
Head Diameter:
1" (25.4mm)
Shoulder Length:
9/64" (3.6mm)
Stem Length: 1-5/8" (41.3mm)
Fits Into 1/2" (12.7mm) Hole
GM Truck 1994 - On

UNIT PACKAGE: 5



19892
(25695687)
Black Nylon

Radiator Support Sight Shield
Push-Type Retainer
Head Diameter: 27mm
Shoulder Length: 7mm
Stem Length: 18mm
(Excluding The Pin)
Fits Into 10mm Hole
Cadillac DeVille & Seville
2000 - On

UNIT PACKAGE: 15



21348
(6508643-AA)
Black Nylon

Tail Light
Push-Type Retainer
Large Head Diameter: 31.5mm
Small Head Diameter: 20mm
Stem Length: 23mm
Fits Into 10mm Hole
Dodge Nitro and Jeep
2008 - On

UNIT PACKAGE: 15



18334
(15959833)
Gray Nylon

Front License
Plate Bracket
Push-Type Retainer
Head Diameter: 1" (25.4mm)
Stem Length: 1-3/4" (44.5mm)
Fits Into 1/2" (12.7mm) Hole
GM S-10 Truck With Decor Package
1994 - On

UNIT PACKAGE: 5



17616
(21077131)
Black Nylon

Bumper Fascia
Push-Type Retainer
Head Diameter:
1-3/16" (30mm)
Stem Length:
2" (51mm)
Fits Into 7/16"
(11mm) Hole
GM Saturn
1991 - On

UNIT PACKAGE: 10



17080
(OH452KD5)

Nylon Quartz Matte Finish
Headliner Retainer
Head Diameter: 1-1/4" (32mm)
Stem Length: 7/16" (11mm)
Fits Into 1/4" (6.4mm) Hole
Dodge Caravan & Plymouth Voyager
1984 - On

UNIT PACKAGE: 15



21238
(22718369)
Black Nylon

Fuel Tank Shield & Miscellaneous
Push-Type Retainer
Head Diameter: 26mm
Stem Length: 12mm
Fits Into 10mm Hole
Chevrolet Malibu & Trail Blazer
2004 - On

UNIT PACKAGE: 25



20940
(55157330-AC)
Black Nylon

Tail Light
Push-Type Retainer
Large Head Diameter: 31mm
Small Head Diameter: 20mm
Stem Length: 21mm
Fits Into 8mm Square Hole
Jeep Commander
2006 - On

UNIT PACKAGE: 15



20963
(4806334-AA)
Black & White Nylon

Rear Bumper
Push-Type Retainer With Sealer
Head Diameter: 34mm
Shoulder Length: 3.5mm
Stem Length: 17mm
Fits Into 8.5mm Hole
Dodge Caliber and
Jeep Compass & Patriot
2007 - On

UNIT PACKAGE: 10

Listed smallest to largest first by Head Diameter then by Stem Length and then by Hole Diameter



19638

(Chrysler: 4805405AA;
Ford: 1L5Z-17K826AA)
Black & White Nylon

Front Bumper Fascia
Push-Type Retainer
Head Diameter: 34mm
Shoulder Length: 3mm
Stem Length: 20mm
Fits Into 8mm Hole

Chrysler Concorde, Intrepid, Eagle,
Pacifica & PT Cruiser
1998 - On
Ford Trucks
2005 - On

UNIT PACKAGE: 15



20923

(Ford: 3M8Z-1502316-A;
Mazda: GJ6E-50-715A)
Black Nylon

Cowl Vent
Push-Type Retainer
Head Size: 8.5mm x 12mm
Stem Length: 9mm
Fits Into 5mm Hole
Ford Fusion, Milan & Zephyr
2006 - On
Mazda 5 & 6
2003 - On

UNIT PACKAGE: 15



14953

(Ford: N803494S;
GM: 15679091)
Black Nylon

Fascia, Trim & Grille Retainer
Head Size" 15/32" x 15/32"
(12mm x 12mm)
Stem Length: 21/32" (16.7mm)
Fits Into 1/4" (6.4mm)
Square Hole Or Slot
Ford Aerostar, Escort & Lynx
1985 - On
GM 1994 - On

UNIT PACKAGE: 25



20407

(9133073-8)
Black Nylon

Hood Insulation & Radiator Seal
Push-Type Retainer
Head Size: 8mm x 25mm
Stem Length: 10mm
Fits Into 5mm Hole
Volvo 850, 940, 960, S80, S90 & V90
1991 - On

UNIT PACKAGE: 25



14725

(66824-W1000)
Black Nylon

Push-Type Retainer
Head Size: 12mm x 18mm
Stem Length: 10mm
Fits Into 6mm Hole
Nissan

UNIT PACKAGE: 15



16115

(5113-885-399)
Black Nylon

Push-Type Retainer
Head Size: 7mm x 15mm
Stem Length: 17mm
Fits Into 6mm x 6mm Hole
BMW

UNIT PACKAGE: 25



19433

(25618359)
Black Nylon

Front Bumper Fascia
Push-Type Retainer
Head Size: 15/32" x 7/8"
(12mm x 22mm)
Stem Length: 15/32" (12mm)
Fits Into 9/32" (7mm) Hole
Buick Park Ave.
1996 - 92

UNIT PACKAGE: 25

**Refer To Push-Type
Retainer Specification
Chart On Pages 450 - 460**



16725

(66814-01G00)
Black Nylon

Cowl Grille Retainer
Head Size: 8mm x 12mm
Stem Length: 8mm
Fits Into 6mm Square Hole
Nissan Pick-Up
1986 - On

UNIT PACKAGE: 25



20203

(124-990-07-92)
Black Nylon

Push-Type Retainer
Head Size: 11mm x 14mm
Stem Length: 8mm
Fits Into 7mm x 8mm Hole
Body Styles
Mercedes-Benz 124, 129, 140, 170,
202, 203, 208, 210, 215 & 220
1986 - On

UNIT PACKAGE: 25



14727

(Nissan: 63844-D0100;
Isuzu: 8942211500)
Black Nylon

Push-Type Retainer
Head Size: 14mm x 22mm
Stem Length: 9mm
Fits Into 7mm Hole
Isuzu & Nissan

UNIT PACKAGE: 25

Listed smallest to largest first by Head Diameter then by Stem Length and then by Hole Diameter



20892

(12337831)
Black Nylon

Front Bumper
Push-Type Retainer
Head Size: 14mm x 26mm
Stem Length: 14mm
Fits Into 8mm Hole
Pontiac G6
2005 - On

UNIT PACKAGE: 50



14008

(14032200)
Black Nylon

Grille Attachment Retainer
Head Size: 19/32" x 3/4"
(15mm x 19mm)
Stem Length: 19/32" (15mm)
Fits Into 5/16" (8mm) Hole
GM
1981 - On

UNIT PACKAGE: 25



14286

(90673-692-0030)
Black Nylon

Push-Type Retainer
Head Size: 15mm x 20mm
Stem Length: 9mm
Fits Into 8mm x 11.5mm Hole
Honda

UNIT PACKAGE: 25



17104

(6501630, 6501772, 6501878)
Black Nylon

Headlight & Tail Light
Panel Attachment
Push-Type Retainer
Head Size: 15mm x 31mm
Stem Length: 17mm
Fits Into 5mm x 6.5mm Hole
Dodge Daytona
1987 - On

UNIT PACKAGE: 10

**Refer To Push-Type
Retainer Specification
Chart On Pages 450 - 460**



16843

(Mazda: BF82-50-233;
Nissan: 01553-01393)
Black Nylon

Bumper Cover
Push-Type Retainer
Head Size: 20mm x 30mm
Stem Length: 18mm
Fits Into 10mm Hole
Mazda & Nissan

UNIT PACKAGE: 10



18029

(4630253)
Black Nylon

Rear Fascia
Push-Type Retainer
Head Size: 7/8" x 1-25/32"
(22mm x 45.5mm)
Stem Length: 1-1/16" (27mm)
Fits Into 1/2" (12.7mm) Hole
Chrysler Concorde & LHS
Dodge Intrepid & Eagle Vision
1993 - On

UNIT PACKAGE: 15



20890

(55157112-AA,
55157112-AB)
Black & Natural Nylon

Bumper Cover
Push-Type Retainer
Head Size: 25mm x 45mm
Shoulder Length: 3mm
Stem Length: 20mm
Fits Into 9.5mm Hole
Jeep Liberty
2005 - On

UNIT PACKAGE: 15

PUSH-TYPE RETAINER SPECIFICATION CHART



Type 1



Type 2



Type 3



Type 4



Type 5



Type 6



Type 7



Type 8



Type 9



Type 10



Type 11

Auveco No.	Type	Head Diameter	Stem Length	Fits In Hole Size	Shoulder Length	Color	Page No.
11699	7	11/16" (17.5mm)	5/8" (16mm)	1/4" (6.4mm)		Black	426
11702	7	25/64" (10mm)	19/32" (15mm)	9/32" (7.1mm)		Natural	414
11704	7	11/16" (17.5mm)	7/16" (11mm)	9/32" (7.1mm)		Black	426
11705	7	19/32" (15mm)	5/8" (16mm)	1/4" (6.4mm)		Black	421
11706	7	3/4" (19mm)	11/16" (17.5mm)	1/4" x 1/4" (6.4mm x 6.4mm)	1/4" (6.4mm)	Black	433
11854	7	7/16" (11mm)	9/32" (7.1mm)	3/16" (4.8mm)		Natural	415
12567	5	11/16" (17.5mm)	9/16" (14.3mm)	1/4" (6.4mm)		Black	426
12756	5	1" (25.4mm)	7/8" (22mm)	1/2" (12.7mm)	1/4" (6.4mm)	Brown	445
12757	5	1" (25.4mm)	3/4" (19mm)	1/2" (12.7mm)	3/4" (19mm)	Black	445
13230	7	10mm	7mm	5mm		Black	414
13457	1 (Phillips Hex Drive)	43/64" (17mm)	23/64" (18.3mm)	5/16" (8mm)		Black	426
13469	1 (Phillips Hex Drive)	3/4" (19mm)	1/2" (12.7mm)	1/4" (6.4mm)		Black	432
13993	6	11/16" (17.5mm)	7/8" (22mm)	1/4" (6.4mm)		Black	426
13994	6	1" (25.4mm)	7/8" (22mm)	5/16" (8mm)		Black	445
13996	6	11/16" (17.5mm)	7/8" (22mm)	9/32" (7.1mm)		Black	427
13999	3	3/8" (9.5mm)	1/2" (12.7mm)	7/32" (5.6mm)		Black	414
14001	5	21/32" (16.7mm)	19/32" (15mm)	5/16" (8mm)		Black	424
14007	5	11/16" (17.5mm)	9/16" (14.3mm)	1/4" (6.4mm)		Black	426
14008	11	19/32" x 3/4" (15mm x 19mm)	19/32" (15mm)	5/16" (8mm)		Black	449

PUSH-TYPE RETAINER SPECIFICATION CHART



Type 1



Type 2



Type 3



Type 4



Type 5



Type 6



Type 7



Type 8



Type 9



Type 10



Type 11

Auveco No.	Type	Head Diameter	Stem Length	Fits In Hole Size	Shoulder Length	Color	Page No.
14010	5	1" (25.4mm)	23/32" (18.3mm)	3/8" (9.5mm)		Black	445
14011	5	21/32" (16.7mm)	9/16" (14.3mm)	5/16" (8mm)		Black	424
14016	3	3/8" (9.5mm)	7/16" (11mm)	3/16" (4.8mm)		Black	414
14018	3	18mm	23mm	7mm		Black	431
14019	6	1" (25.4mm)	7/8" (22mm)	5/16" (8mm)	1/8" (3.2mm)	Black	445
14020	6	1" (25.4mm)	7/8" (22mm)	1/4" (6.4mm)		Black	445
14147	6	1" (25.4mm)	7/8" (22mm)	1/4" (6.4mm)		Black	445
14260	1	15mm	12mm	7mm		Black	420
14286	10	15mm x 20mm	9mm	8mm x 11.5mm		Black	449
14369	1	20mm	9mm	6mm		Black	434
14696	1	15mm	11mm	6mm		Black	419
14697	1	14mm	11mm	7mm		Black	418
14698	1	18mm	11mm	6mm		Black	428
14725	10	12mm x 18mm	10mm	6mm		Black	448
14726	1	17mm	18mm	8mm		Black	425
		(Phillips Hex Drive)					
14727	10	14mm x 22mm	9mm	7mm		Black	448
14753	2	11/16" (17.5mm)	7/8" (22mm)	1/4" (6.4mm)		Black	427
14953	10	15/32" x 15/32" (12mm x 12mm)	21/32" (16.7mm)	1/4" x 1/4" (6.4mm x 6.4mm)		Black	448
14963	5	13mm	7mm*	7mm x 7mm		Light Palomino	417
14987	2	11mm (7/16")	18mm (11/16")	6mm (15/64")		Black	415
14988	2	7/16" (11mm)	11/16" (17.5mm)	15/64" (6mm)		Black	415
14990	2	7/16" (11mm)	15/32" (11.9mm)	15/64" (6mm)		Black	415
		(With Torx Drive)					
14991	2	11/16" (17.5mm)	11/16" (17.5mm)	1/4" (6.4mm)		Black	426
14992	2	19/32" (15mm)	29/32" (23mm)	1/4" (6.4mm)		Black	421
14993	2	11/16" (17.5mm)	7/8" (22mm)	1/4" (6.4mm)		Black	427

*Not Including The Pin

PUSH-TYPE RETAINER SPECIFICATION CHART



Type 1



Type 2



Type 3



Type 4



Type 5



Type 6



Type 7



Type 8



Type 9



Type 10



Type 11

Auveco No.	Type	Head Diameter	Stem Length	Fits In Hole Size	Shoulder Length	Color	Page No.
14994	2	1" (25.4mm)	29/32" (23mm)	1/4" (6.4mm)		Black	446
14995	2	1/2" (12.7mm)	1-13/64" (30.5mm)	9/32" (7mm)		Black	417
14997	2	19/32" (15mm)	13/16" (20.6mm)	5/16" (8mm)		Black	421
14998	2	27/32" (21.4mm)	1" (25.4mm)	13/32" (10.3mm)		Black	441
15042	6	1" (25.4mm)	1-1/8" (28.5mm)	1/2" (12.7mm)	1/4" (6.4mm)	Black	446
15043	6	7/8" (22mm)	1-3/64" (26.5mm)	1/2" (12.7mm)	5/32" (4mm)	Black	443
15044	6	1" (25.4mm)	1" (25.4mm)	1/2" (12.7mm)	1/8" (3.2mm)	Black	446
15045	6	1" (25.4mm)	1-7/64" (28.2mm)	1/2" (12.7mm)	1/8" (3.2mm)	Black	446
15522	5	5/8" (16mm)	17/32" (13.5mm)	1/4" (6.4mm)		Black	423
15672	1 (Phillips Hex Drive)	17mm	14mm	8mm (5/16")		Black	425
15701	6	25mm	27mm	7mm		Black	444
15702	6	1" (25.4mm)	15/16" (24mm)	1/2" (12.7mm)	1/8" (3.2mm)	Black	446
16000	1	20mm	9mm	8mm		Black	435
16115	10	7mm x 15mm	17mm	6mm x 6mm		Black	448
16265	5	1" (25.4mm)	3/4" (19mm)	1/2" (12.7mm)	3/4" (19mm)	Black	445
16622	6	18mm	23mm	9.5mm (3/8")		Black	431
16624	3	17mm	18mm	9.5mm (3/8")	2mm	Black	425
16625	6	20mm	20mm	10mm x 10mm		Black	440
16725	11	8mm x 12mm	8mm	6mm x 6mm		Black	448
16726	3	18mm	18mm	6.3mm x 6.3mm		Black	430
16782	8	20mm	8mm*	8mm		Black	437
16783	8	12mm	8mm*	6mm		Black	416
16784	8	18mm	11mm*	7mm		Black	428
16816	3	14mm	14mm	6mm		Black	418
16835	2	27/32" (21mm)	1" (25mm)	1/2" (12mm)	1/8" (3mm)	Black	441

*Not Including The Pin

PUSH-TYPE RETAINER SPECIFICATION CHART



Type 1



Type 2



Type 3



Type 4



Type 5



Type 6



Type 7



Type 8



Type 9



Type 10



Type 11

Auveco No.	Type	Head Diameter	Stem Length	Fits In Hole Size	Shoulder Length	Color	Page No.
16843	10	20mm x 30mm	18mm	10mm		Black	449
16858	2	25/32" (20mm)	23/32" (18mm)	5/16" (8mm)		Black	439
16859	2	9/16" (14mm)	5/8" (16mm)	1/4" (6mm)		Black	418
17057	2	18mm	21mm	8mm		Black	431
17080	7	1-1/4" (32mm)	7/16" (11mm)	1/4" (6.4mm)		Quartz Matte Finish	447
17081	1	18mm	12mm	6mm		Black	428
17103	3	15mm	23mm	6mm		Black	421
17104	10	15mm x 31mm	17mm	5mm x 6.5mm		Black	449
17106	3	1/2" (12.7mm)	7/16" (11mm)	3/16" (4.8mm)		Black	417
17143	2	20mm	27mm	10mm		Black	441
17144	2	20mm	24mm	10mm		Black	440
17162	8	15mm	8mm*	6.3mm		Black	420
17192	4	18mm	14mm	8mm		Black	429
17206	1	15mm	12mm	9mm		Black	420
17214	2 (Torx Drive)	7/16" (11mm)	11/16" (18mm)	15/64" (6mm)		Black	415
17216	3	20mm	20mm	8mm		Black	439
17222	3	15mm	20mm	8mm		Black	421
17226	3	15mm	29mm	8mm		Black	422
17227	7	7mm	10mm	5mm		Black	414
17267	1	20mm	15mm	10mm		Black	438
17287	1	13mm	11mm	6mm		Black	417
17347	8	20mm	11mm*	8mm		Black	436
17350	1 (Phillips Hex Drive)442	20mm	15mm	8mm		Black	438
17351	1	17mm	10mm	7mm		Black	425
17378	1	22mm	14mm*	11mm		Black	442
17379	1	20mm	9mm	8mm		Black	435
17383	8	11mm	14mm*	7mm		Black	415
17439	2	15mm	27mm	9mm		Black	422
17472	2	20mm	20mm	8mm		Black	439
17478	3	14mm	16mm	6mm		Black	418
17616	6	1-3/16" (30mm)	.2" (51mm)	7/16" (11mm)		Black	447

*Not Including The Pin

Sec. 19

PUSH-TYPE RETAINER SPECIFICATION CHART



Type 1



Type 2



Type 3



Type 4



Type 5



Type 6



Type 7



Type 8



Type 9



Type 10



Type 11

Auveco No.	Type	Head Diameter	Stem Length	Fits In Hole Size	Shoulder Length	Color	Page No.
17632	1	18mm	12mm	8mm		Black	428
17988	2	19mm	26mm	9mm		Black	433
17992	1	20mm	12mm	7mm		Black	436
18029	Misc.	7/8" x 1-25/32" (22mm x 45.5mm)	1-1/16" (27mm)	1/2" (12.7mm)		Black	449
18030	6	11/16" (17.5mm)	13/16" (20.6mm)	1/4" (6.4mm)		Black	426
18032	2	15/32" (11.9mm)	9/16" (14.3mm)	1/4" (6.4mm)		Black	416
18119	1	20mm	25mm	10mm		Black	440
18165	4	17mm	9mm	8mm		Black	425
18206	4	18mm	12mm	6mm		Gray	428
18265	6	16mm	20mm	8mm		Black	424
18268	6	1" (25.4mm)	1-5/8" (41.3mm)	1/2" (12.7mm)	9/64" (3.6mm)	Black	447
18269	5	7/8" (22mm)	1" (25.4mm)	1/4" (6.4mm)		Black	443
18270	8	17mm	9mm	7mm		Black	424
18308	3	3/4" (19mm)	1-1/8" (28.5mm)	1/4" (6.4mm)		Black	433
18310	6	1" (25.4mm)	15/16" (24mm)	3/8" (9.5mm)		Black	446
18327	5	11/16" (17.5mm)	5/8" (16mm)	1/4" (6.4mm)		Black	426
18334	6	1" (25.4mm)	1-3/4" (44.5mm)	1/2" (12.7mm)		Gray	447
18353	9	9/16" (14.3mm)	41/64" (16.3mm)	1/4" (6.4mm)		White	419
18394	3	1" (25.4mm)	1-1/8" (28.5mm)	1/4" (6.4mm)		Black	446
18503	6	1" (25.4mm)	1" (25.4mm)	5/16" (8mm)		Black	446
18873	3	18mm	28mm	9mm		Black	432
18888	4	20mm	8mm*	7mm		Black	434
18893	1	11/16" (17.5mm)	1/2" (12.7mm)	1/4" (6.4mm)		Black	426
18894	1	11/16" (17.5mm)	3/4" (19mm)	1/4" (6.4mm)		Black	426
18895	1	11/16" (17.5mm)	1-3/32" (28mm)	1/4" (6.4mm)		Black	427
18896	3	20mm	28mm	8mm		Black	441
18933	7	7/16" (11mm)	1/2" (12.7mm)	1/4" (6.4mm)		Black	415

*Not Including The Pin

PUSH-TYPE RETAINER SPECIFICATION CHART



Type 1



Type 2



Type 3



Type 4



Type 5



Type 6



Type 7



Type 8



Type 9



Type 10



Type 11

Auveco No.	Type	Head Diameter	Stem Length	Fits In Hole Size	Shoulder Length	Color	Page No.
18939	2	18mm	23mm	9mm		Black	431
18951	1	20mm	26mm	8mm		Black	440
19013	4	15mm	10mm	7mm		Black	419
19118	4	20mm	10mm	8mm		Black	436
19128	1	20mm	9mm	7mm		Black	434
19140	1	20mm	21mm	8mm		Black	440
19142	1	15mm	13mm	7mm x 7mm		Black	420
19186	4	11mm	10mm	8mm		Black	415
19195	7	16mm	12mm	8mm		Black	423
19219	Misc.	15mm	27mm	9mm		Black	422
19231	8	18mm	16mm	8mm		Black	429
19232	1	17mm	13mm	7mm		Black	425
19233	4	20mm	13mm	10mm		Black	437
19239	4	20mm	11mm	8mm		Black	436
19242	2	13/32" (10.3mm)	11/16" (17.5mm)	7/32" (5.6mm)		Black	415
19243	1	16mm	10mm*	9mm		Black	422
19244	6	1" (25.4mm)	11/16" (17.5mm)	1/4" x 1/4" (6.4mm x 6.4mm)		Black	445
19245	3	3/4" (19mm)	1-1/8" (28.5mm)	1/4" (6.4mm)		Black	433
19246	4	18mm	15mm	10mm		Black	429
19248	7	16mm	14mm	6mm		Black	423
19249	7	16mm	12mm	8mm		Black	423
19274	4	20mm	9mm*	8mm		Black	435
19297	8	16mm	12mm*	7mm		Black	423
19306	1	16mm	12mm	6mm		Black	423
19311	1	15mm	13mm	6mm		Black	420
19315	1	20mm	9mm*	8mm		Black	435
19337	Misc.	14mm	23mm	6.3mm		Black	419
19355	6	17/32" (13.5mm)	1-5/64" (27.5mm)	1/4" (6.4mm)		Black	417
19407	2	20mm	27mm	10mm		Black	441
19408	2	20mm	24mm	10mm		Black	440
19416	8	18mm	12mm*	9mm		Black	429
19422	4	23/32" (18.3mm)	29/32" (23mm)	5/16" (8mm)		Black	432
19433	11	15/32" x 7/8" (12mm x 22mm)	15/32" (12mm)	9/32" (7mm)		Black	448

*Not Including The Pin

PUSH-TYPE RETAINER SPECIFICATION CHART



Type 1



Type 2



Type 3



Type 4



Type 5



Type 6



Type 7



Type 8



Type 9



Type 10



Type 11

Auveco No.	Type	Head Diameter	Stem Length	Fits In Hole Size	Shoulder Length	Color	Page No.
19453	4	18mm	15mm*	8mm		Black	429
19490	1	18mm	8mm	6mm		Black	427
19511	9	29/32" (23mm)	11/16" (17.5mm)	3/8" (9.5mm)		White	422
19522	3	12mm	18mm	6mm x 6mm		Black	416
19546	1	17mm	16mm	7mm x 7mm		Black	425
19547	4	17mm	13mm*	9mm		Black	425
19552	1	16mm	9mm	7mm		Black	422
19607	7	16mm	12mm	10mm		Natural	423
19615	3	20mm	21mm	9mm		Black	440
19638	Misc.	34mm	20mm	8mm	3mm	Black & White	448
19639	3	17mm	16mm	6mm		Black	425
19645	1	14mm	8mm*	6mm		Gray	418
19726	1	14mm	8mm*	6mm		Black	418
19739	2	20mm	26mm	9mm		Black	441
19747	1	18mm	10mm	8mm		Black	427
19787	2	12mm	17mm	6mm		Black	416
19788	2	11mm	20mm	6mm		Black	416
19801	3	19/32" (15mm)	3/4" (19mm)	1/4" (6.4mm)		Black	421
19847	5	7/8" (22mm)	25/32" (20mm)	1/2" (12.7mm)	5/32" (4mm)	Blue	442
19849	2	18mm	18mm	8mm		Black Nylon & Santoprene Rubber	430
19854	5	7mm	10mm	5mm		Black	414
19892	8	27mm	18mm*	10mm	7mm	Black	447
19904	7	16mm	14mm	9mm		Black	424
19905	1	20mm	8mm*	8mm		Black	434
19907	1	20mm	8mm*	7mm		Gray	434
19908	1	20mm	8mm*	7mm		Black	434
20163	Misc.	12.5mm	17mm	6mm		Black	417
20169	9	15mm	13mm	7mm		White	420
20187	7	10mm	10mm	6mm		Black	414
20196	1	14mm	8mm	6mm		Black	418
20203	Misc.	11mm x 14mm	8mm	7mm x 8mm		Black	448
20233	8	25mm	12mm*	9mm	3mm	Black	444
20234	5	15mm	15mm	6.3mm		Black	421
20244	9	19mm	32mm	8mm		Green With Sealer	433
20247	4	18mm	12mm	9mm		Black	428

*Not Including The Pin

PUSH-TYPE RETAINER SPECIFICATION CHART



Type 1



Type 2



Type 3



Type 4



Type 5



Type 6



Type 7



Type 8



Type 9



Type 10



Type 11

Auveco No.	Type	Head Diameter	Stem Length	Fits In Hole Size	Shoulder Length	Color	Page No.
20248	5	20mm	17mm	6.3mm		Black	439
20265	2	1" (25.4mm)	1" (25.4mm)	1/4" (6.4mm)		Black	446
20270	5	20mm	9mm	7mm		Black	434
20273	8	19mm	22mm	9mm	7mm	Gray	433
20310	7	5/8" (16mm)	7/16" (11mm)	1/4" (6.4mm)		Black	423
20314	7	13mm	14mm	8mm		Black	417
20327	4	18mm	22mm	9mm		Black	431
20335	4	18mm	7mm	7mm		Black	427
20337	3	20mm	39mm	6mm		Black	441
20348	2	20mm	22mm	8mm		Black	440
20349	4	18mm	12mm	8mm		Black	428
20352	2 (With Slotted Drive)	16mm	21mm	8mm		Black	424
20359	6	18mm	26mm	10mm		Black	432
20363	9	20mm	12mm*	9mm		White	420
20365	4	18mm	13mm	7.5mm x 7.5mm		Black	429
20367	2	18mm	18mm	8mm		Black	430
20388	1	20mm	16mm	7mm		Black	438
20407	11	8mm x 25mm	10mm	5mm		Black	448
20457	3	21mm	23mm	9.5mm		Black	441
20458	6	20mm	17mm	7mm		Black	439
20465	1	18mm	9mm	8mm		Black	427
20516	1 (Hex Drive)	20mm	13mm	8mm		Black	437
20518	Misc.	24.5mm	14mm*	9mm		Black	444
20542	6	16.5mm	27mm	8mm		Black	424
20545	2	18mm	18mm	6.3mm		Black Nylon & Santoprene Rubber	430
20564	4	20mm	18mm	10mm		Black	439
20577	1	20mm	8mm*	7mm		Black	434
20580	4	14mm	12mm	7mm		Black	420
20608	4	20mm	14mm	10mm		Black	438
20613	2	18mm	20mm	9mm		Black	431
20631	6	18mm	26mm	10mm		Black	432
20632	3	20mm	26mm	8mm		Black	441
20636	5	12mm	10mm	8.5mm		Dark Gray	416
20637	5	20mm	9mm	8mm		Black	435
20638	5	20mm	14mm	8.5mm		Black	437
20639	1	12mm	11mm	5mm x 5mm		Black	416

*Not Including The Pin

PUSH-TYPE RETAINER SPECIFICATION CHART

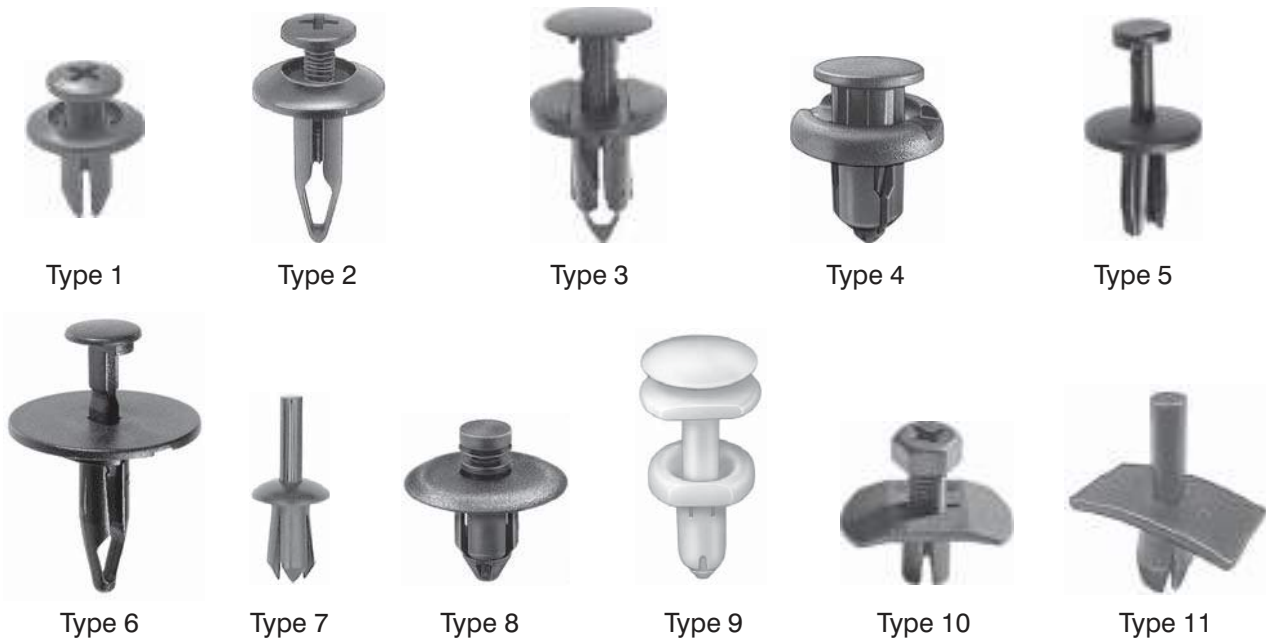

Auveco No.	Type	Head Diameter	Stem Length	Fits In Hole Size	Shoulder Length	Color	Page No.
20640	1	12mm	11mm	5mm		Black	416
20666	8	12mm	14mm*	6mm		Gray	416
20734	7	20mm	15mm	6.3mm		Black	438
20739	8	22mm	10mm*	9mm		Black	442
20753	2	22mm	21mm	8mm		Black	443
20755	4	19.5mm	15mm	10mm		Black	433
20766	7	20mm	16mm	10mm		Black	439
20767	Misc.	24mm	20mm	11mm	3mm	Black & White	443
20768	4	18.5mm	21mm	8mm		Black With Sealer	432
20772	4	15mm	11mm	5mm		Black	419
20826	3	19mm	14mm	8.5mm		Black	432
20863	4	22mm	13mm*	15mm		Black	442
20869	4	18mm	7.5mm	7mm		Black	427
20880	3	18mm	20mm	6.5mm		Black	430
20888	3	18mm	20mm	9.5mm		Black	431
20889	3	20mm	22mm	8.5mm		Black	440
20890	Misc.	25mm x 45mm	20mm	9.5mm	3mm	Black & Natural	449
20892	10	14mm x 26mm	14mm	8mm		Black	449
20908	4	20mm	10mm	7mm		Black	435
20909	6	16mm	18mm	7mm		Black	424
20910	8	17mm	12mm	8mm		Black	425
20923	10	8.5mm x 12mm	9mm	5mm		Black	448
20931	3	18mm	31mm	9mm		Black	432
20940	Misc.	20mm	21mm	8mm x 8mm		Black	447
20943	2	14mm	23mm	7mm		Black	419
20948	8	22mm	10mm*	9mm		Tan	442
20953	4	20mm	13mm	8mm		Black	437
20963	Misc.	34mm	17mm	8.5mm	3.5mm	Black & White	447
20966	4	18mm	20mm	8mm		Black	431
20967	7	22mm	16mm	10mm		Black	442
20986	4	20mm	13mm	10mm		Black	437
20988	3	18mm	17.5mm	6.5mm		Black	429
20989	3	18mm	22mm	6.5mm		Black	431
20990	3	19mm	16mm	8mm		Black	433
20991	3	20mm	20mm	8.5mm		Black	439
20992	3	20mm	24mm	8.5mm		Black	440
20993	3	25mm	20mm	10.5mm		Black	444
20994	3	25mm	23mm	10.5mm		Black	444
21010	1	20mm	9mm	9mm x 9mm		Black	435
21011	4	15mm	17mm	7mm		Black	421
21021	8	22mm	10mm*	9mm		Gray	442

*Not Including The Pin

PUSH-TYPE RETAINER SPECIFICATION CHART

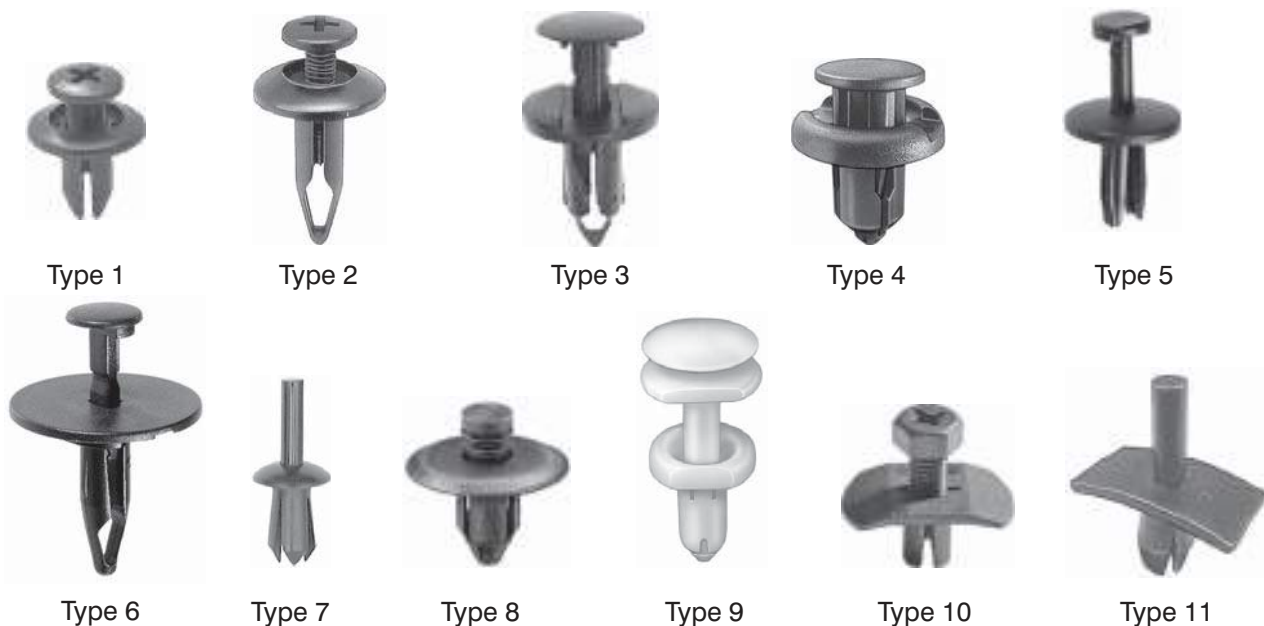

Auveco No.	Type	Head Diameter	Stem Length	Fits In Hole Size	Shoulder Length	Color	Page No.
21024	4	18mm	10mm	6mm		Black	427
21037	7	10mm	10mm	6mm		Black	414
21044	1	16mm	11mm	6.3mm		Black	422
21086	5	20mm	10mm	8mm		Black	436
21089	1	18mm	18mm	8mm		Black	430
21098	1	18mm	18mm	6.4mm		Black	430
21103	1	10mm	12mm	5mm		Black	414
21104	1	14mm	14mm	7mm		Black	418
21110	8	18mm	12mm	8.5mm		Black	428
21112	2	15mm	14mm	6mm		Black	421
21119	2	20mm	19mm	6mm		Black	439
21120	8	15mm	9mm*	7mm		Black	421
21123	4	18mm	12mm*	8mm		Black	430
21134	8	20mm	11mm*	8mm		Black	437
21140	8	15mm	12mm	6.3mm		Black	420
21141	9	18mm	13mm	8mm		Black & White	429
21146	1	18mm	12mm	8mm		Black	428
21172	1	13mm	18mm	8mm		Black With Sealer	417
21173	4	20mm	16mm	10mm		Black	438
21176	Misc.	24.5mm	13mm*	9mm		Black	444
21190	8	16mm	14mm	7mm		Black	424
21192	4	20mm	12mm	8mm		Black	437
21201	4	19mm	8mm	7mm		Black	432
21218	1	11mm	8mm	5mm		Black	415
21225	5	18mm	14mm	7mm		Black	429
21233	2	10mm	13mm	5mm		Black	414
21238	7	26mm	12mm	10mm		Black	447
21246	8	12mm	14mm*	6mm		Black	416
21249	8	11mm	9mm*	7mm		Black	415
21251	Misc.	22.5mm	8mm*	8mm		Black & White	443
21294	4	20mm	9mm	7mm		Black	434
21297	4	20mm	11mm	10mm		Black	436
21311	1	18mm	12mm	8mm		Gray	428
21325	1	16mm	14mm	7mm		Black	424
21328	8	15mm	10mm	7mm		Black	419
21348	Misc.	20mm	23mm	10mm		Black	447
21361	6	25mm	29mm	7mm		Black	445
21366	4	22mm	15mm*	9mm		Black	442
21376	Misc.	24mm	20mm	11mm	3mm	Black & White	443
21391	7	12mm	11mm	8mm		Dark Gray	416

*Not Including The Pin

PUSH-TYPE RETAINER SPECIFICATION CHART

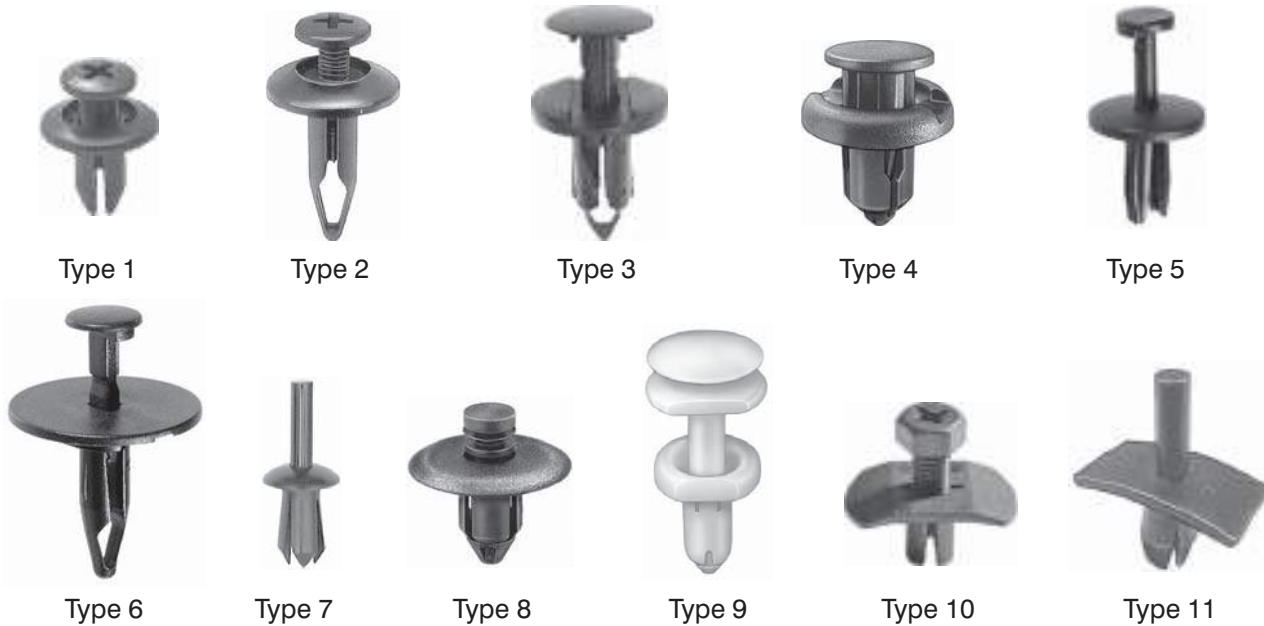

Auveco No.	Type	Head Diameter	Stem Length	Fits In Hole Size	Shoulder Length	Color	Page No.
21400	Misc.	23.5mm	36mm	10mm		Natural	444
21420	4	21mm	15mm*	10mm		Black	441
21422	4	20mm	9mm*	7mm		Black	435
21427	8	22mm	10mm*	9mm		Gray	442
21451	4	14mm	10mm	8.5mm		Black	418
21452	1	16mm	15mm	8mm x 8mm		Black	443
21454	Misc.	20mm	13mm	10mm		Black	437
21477	8	16mm	14mm	7mm		Gray	424
21479	1 (Allen Drive)	18.5mm	11mm	9mm		Gray	432
21482	1	24mm	13mm	9mm x 9mm		Black	443
21500	1 (Slotted Drive)	20mm	12mm	7mm		Black	437
21501	4	25mm	12mm*	11mm	3mm	Black With Sealer	444
21525	8	19mm	9mm	7mm		Black	432
21529	3	18mm	22mm	6.5mm		Black With Sealer	431
21530	1	18mm	10mm	8mm		Black	427
21545	1	20mm	15mm	8mm		Black	438
21547	4	18mm	10mm	9mm		Black	428
21563	4	20mm	15mm	10mm		Black	438
21566	1	16mm	13mm	7mm		Black	423
21568	Misc.	14mm	15mm	10mm		Black	433
21570	1	16mm	11mm	6mm		Black	422
21571	1	20mm	10mm	8mm		Black	435
21576	4	25mm	16mm*	11mm	3mm	Black With Sealer	444
21578	2	22mm	28mm	10mm		Black	443
21580	1	20mm	12mm	7mm		Black	436
21585	5	9mm	7mm	4mm		Black	414
21592	1 (Slotted Drive)	20mm	11mm	7mm		Black	436
21593	1	15mm	8mm	7mm		Black	419
21594	1	20mm	11mm	7mm		Black	436
21595	2	1/2" (12.7mm)	1-7/32" (31mm)	9/32" (7mm)		Natural	417
21596	4	20mm	16mm	8mm		Black	438
21601	9	22mm	16mm	9mm		White Nylon & Black Rubber Seal	423
21620	2	15mm	14mm	5mm		Black	421
21624	1	16mm	10mm	8mm		Black	422
21631	4	20mm	8mm*	8mm		Black	434
21645	7	15mm	15mm	6.3mm		Black	421
21651	4	20mm	10mm	8mm		Black	436
21658	4	15mm	11mm	6mm		Black	419
21662	8	11mm	11mm	7mm		Black	415
21663	1	10mm	9mm	5mm		Black	414
21672	6	18mm	20mm	6.3mm		Black With Sealer	430

*Not Including The Pin



15301

Clip Removal Tool

The right tool for removing clips and retainers quickly and easily. Simply seat the tool on the shaft of the fastener and squeeze the handles together. Made of high carbon steel and heat treated for strength. Zinc plated with vinyl molded handle grips.

UNIT PACKAGE: 1

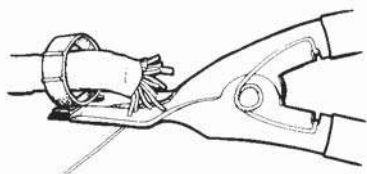

• Wiring Stays

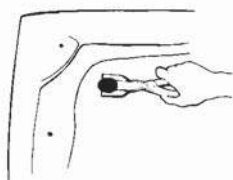

• Hood Insulation

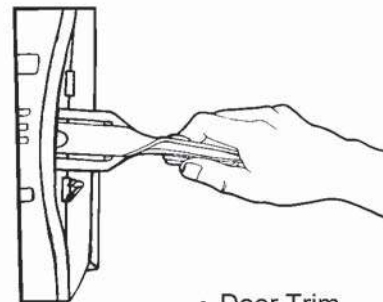

• Door Trim

TRUCK SEAT SPRINGS

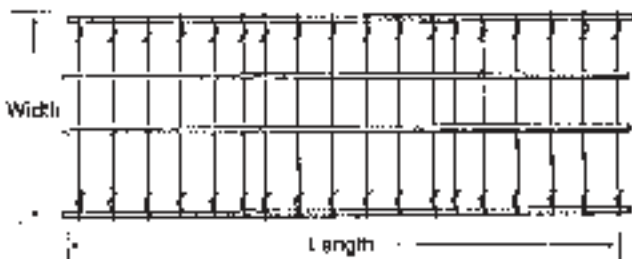

16213

(E0TB-1063-226AC,
E3TB-1063-226AA)

Ford Full Size Pick-Ups
& Light Truck 1980-On
Length: 52", Width: 16-3/4"
No. of Wires: 52

UNIT PACKAGE: 5

16214

(E27B-1063-226AC)

Ford Ranger, Courier & Yuma 1982-On
Length: 45", Width: 15-3/4"
No. of Wires: 45

UNIT PACKAGE: 5



Wire Bending Tool

For Truck Seat Springs

16894

UNIT PACKAGE: 1

A tough tool that makes difficult wire repairs easy. You can bend the ends of no sags, edgewise and foam springs right on the spot, making offsets where you need them. Can be readily mounted in a vise for duplicating complex repetitive wire bends. Constructed of heat-hardened steel for long life.

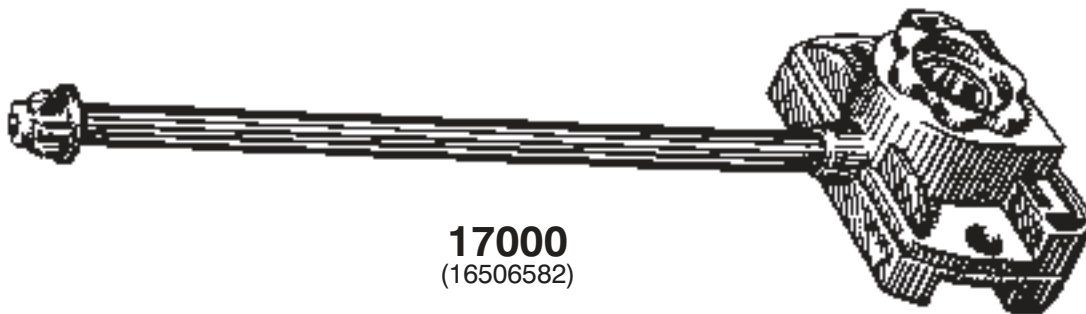

17000
(16506582)

Horizontal Headlight Adjuster
Chevrolet Corsica
& Lumina (APV),
Olds Silhouette (APV)
and Pontiac Trans Sport (APV)
1987-On

UNIT PACKAGE: 2



11243

(343543, 343555,
354076, 362379)

1/4"-28 x 2"
Headlight Adjusting Screw & Nut Assembly
GM 1962-On

UNIT PACKAGE: 10

11244

Same as 11243 except packing

UNIT PACKAGE: 100



11245

(343543, 343555,
354076, 362379,)
Nylon

Headlight Adjusting Nut
GM 1962-On

UNIT PACKAGE: 50



11246

(343543, 354076,
9438150, 15705372)
Zinc

1/4"-28 x 2"
Headlight Adjusting Screw
GM 1962-On

UNIT PACKAGE: 25



10759

(GM: 1600375, 1606642, 1618890;
AMC: SF 400 6204)

1/4"-28 x 1-7/8"
Headlight Adjusting Screw & Nut
Assembly
Cadillac & Oldsmobile 1975-On
AMC

UNIT PACKAGE: 10

11470

Same as 10759 except packing

UNIT PACKAGE: 25

11657

Same as 10759 except packing

UNIT PACKAGE: 100



11826

(365270)
Green Nylon

1/4"-28 x 2"
Headlight Adjusting
Screw & Nut
Assembly
Cars with Fiberglass
Panels
GM 1976-On

UNIT PACKAGE: 25



11718

(365270)
Green Nylon

Headlight Adjusting Nut
For Cars With Fiberglass Panels
GM
1976-On

UNIT PACKAGE: 50



11665

(556196, 557057)
Nylon

#12-28 x 1-3/4"
Headlight Adjusting Screw
& Nut Assembly
GM 1975-On

UNIT PACKAGE: 25



11655

(557057, 559312)
Nylon

#12-28 x 1-3/4"
Headlight Adjusting Screw & Nut
Assembly
GM 1975-On

UNIT PACKAGE: 25

11656

Same as 11655 except packing

UNIT PACKAGE: 100



11667

(556539)
Nylon

#12-28 x 1-3/4"
Headlight Adjusting Screw & Nut
Assembly
Buick & Oldsmobile 1977-On

UNIT PACKAGE: 25



12605

(22512857, 22513813)
Nylon

#12-28 x 1-3/4"
Headlight Adjusting Screw & Nut
Assembly
Camaro & Firebird 1975-On

UNIT PACKAGE: 10

Please Order
In Unit Package
Quantities
Not In Number
Of Pieces



11871
(559312)
Nylon

#12-28 x 1-11/16"
Headlight Adjusting
Screw & Nut Assembly
Chevrolet, Oldsmobile & Pontiac
1975-On

UNIT PACKAGE: 10



9851
(3921446)
White Nylon

Headlight Adjusting Nut
Use With 1/4"-28 Screw
Chevrolet

UNIT PACKAGE: 50



5788
Nylon

Headlight Adjusting Nut
Chevrolet: All Early Models

UNIT PACKAGE: 50



5789

Headlight Adjusting Screw & Nut
Assembly
Chevrolet

UNIT PACKAGE: 25 Sets



3209
Zinc

1/4"-28 x 1"
Headlight Adjusting Screw
UNIT PACKAGE: 50



3178
(5949838)

Headlight Adjusting Screw & Nut
Assembly
Chevrolet, Buick & Pontiac
UNIT PACKAGE: 10 Sets



20378

(Not Supplied By O.E.M.)
White Nylon

Headlight Adjusting Screw Nut
Component of Auveco 3178
Headlight Adjusting Screw Assy.
Buick, Chevrolet & Pontiac

UNIT PACKAGE: 25



Not Actual Size

19486

(10298115)
Natural Nylon

Headlight Retainer
Width: 1-1/8"
Length: 4-9/16"
Buick Century & Regal
And Oldsmobile Intrigue
1997-On

UNIT PACKAGE: 10



Not Actual Size

20864

(15281294)
White Nylon

Headlight Retainer
Width: 1-1/8"
Length: 5-9/16"
Chevrolet Impala & Monte Carlo
2006 - On

UNIT PACKAGE: 10



10090

(3923948)

Headlight Adjusting Spring
Chevrolet 1968-On

UNIT PACKAGE: 25



11253

(3455559)

Headlight Adjusting Spring
Chevrolet 1977-75

UNIT PACKAGE: 10



11252

(413851, 22537990)

Headlight Adjusting Spring
GM 1990-75

UNIT PACKAGE: 10

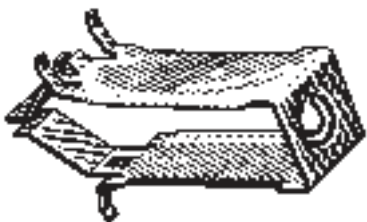

14821

(22514924)

Headlight Mounting Bezel Nut
Screw Size: #8 (M4.2-1.41)
2" Long
Oldsmobile 1982-On

UNIT PACKAGE: 25

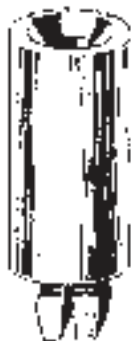

8942

(3863669)

Nylon

Radiator Grille to Headlight Nut
#8 or #10 Screw Size
Chevrolet

UNIT PACKAGE: 25

**E-mail Your New
Product Suggestions
To mail@auveco.com**



18507

(15622475)

Nylon

Grille/Parking Light
Spacer Nut
GM Trucks
C & K, 1, 2, 3
1990-On

UNIT PACKAGE: 10



20433

(3547221)

Yellow Nylon

Nylon Nut
#6 Screw Size
Head Size: 3/8" x 3/8"
Moulding Attachment
1994 - On

UNIT PACKAGE: 50



15676

(16510893)

Natural Nylon

Composite Headlight Nut
#6 Screw Size
3/8" Sq. Head
Buick Electra (FWD)
1987-On

UNIT PACKAGE: 50



9829

(380382)

Natural Nylon

Headlight Bezel To Body Nut
#6 or #8 Screw Size
GM

UNIT PACKAGE: 50



14002

(16503329)

Black Nylon

#6 Screw Size
3/8" Sq. Head
Fits 1/4" Sq. Hole
GM

UNIT PACKAGE: 100



11838

(1254815)

Natural Nylon

#6 Screw Size
Panel Range: .060"-.150"
GM 1977-On

UNIT PACKAGE: 50



13450

(347347)

Natural Nylon

Front Lights
#8 Screw Size
Panel Range: 1/16"-5/32"
GM 1967-On

UNIT PACKAGE: 50



10330

(3893980)

Natural Nylon

Front End & Instrument Panel Nut
#8 Screw Size
GM 1967-On

UNIT PACKAGE: 100



11691
(3919773)
Natural Nylon

Headlight Bezel Nut
#8 Screw Size
GM 1974-On

UNIT PACKAGE: 100



14014
(GM: 20475950,
20624923;
VW: 175-853-674)
Black Nylon

Air Vent Nut
Use w/14013
GM & VW

UNIT PACKAGE: 50



11308
Natural Nylon

Nylon Nut
#8 or #10 Screw Size

UNIT PACKAGE: 50



11424
(3985058)
Natural Nylon

Truck Grille Nut
#6 or #8 Screw Size
GM Trucks 1974-On

UNIT PACKAGE: 25



13933
Natural Nylon

Grille Nut
#8 or #10 Screw Size
1/2" Head Size

UNIT PACKAGE: 50



14145
(16503548)
Nylon &
Stainless Steel

Headlight Glass nut
GM 1983-On

UNIT PACKAGE: 25



11855
(GM: 9669486;
Renault: 8934-201-262)
Natural Nylon

Side Marker Nut
GM 1980-On
Rear License Plate Bracket
AMC/Renault
#8 Screw Size

UNIT PACKAGE: 25



12735
(GM: 1370853;
Chry: 6029501;
VW: 179-813-883)
Natural Nylon

Headlight Bezel Nut
#6 Screw Size
GM, Chrysler & VW 1982-On

UNIT PACKAGE: 50



9069
(1355003)
Natural Nylon

Headlight Door to Radiator Grille
Anchor Nut
#6 or #8 Screw Size
Buick 1964-On

UNIT PACKAGE: 50



13960
(14013246)
Natural Nylon

Headlight Bezel Nut
Fits Into 5/16" Hole
#8 Screw Size
GM 1967-On

UNIT PACKAGE: 50



10305
Natural Nylon

Nylon Nut
#8 Screw Size

UNIT PACKAGE: 50



14030
(GM: 3997391;
VW: 179-813-881)
Black Nylon

Tail Light Nut
#8 Screw Size
GM Astro & Safari
1985-On
Volkswagen

UNIT PACKAGE: 25



14031
(12337852,
15596279,
21035018)
Black Nylon

Grille Retainer & Cowl Vent Nut
#8 or #10 Screw Size
Astro, Safari & Saturn 1985-On

UNIT PACKAGE: 25



13827
(GM: 10027915)
Natural Nylon

Speaker Grommet
Pontiac Fiero

UNIT PACKAGE: 50



21347
(10351052)
White Nylon

Trim Panel Grommet
With Sealer
Head Size: 12mm x 14.5mm
Stem Length: 15mm
Fits Into 7mm Hole

Mates With Auveco No. 21346
Cadillac, Chevrolet Camaro &
Corvette and Pontiac Firebird
2004 - On

UNIT PACKAGE: 15



17271

(94113207)
Natural Nylon

Cowl Cover Retaining Clip
Head Diameter: 23mm
Chev. Spectrum
1989-85

UNIT PACKAGE: 15



19247

(10262143)
Black Nylon

Air Intake Grille
Panel Grommet
For 5mm Stud
Buick Regal & Century
Chevrolet Lumina & Monte Carlo
Oldsmobile Cutlass
Pontiac Grand Prix
1996-On

UNIT PACKAGE: 25



11836

(559547)
Natural Nylon

Screw Grommet
#14 Screw Size
GM 1960-On

UNIT PACKAGE: 25



19194

(Toyota: 90189-06028;
GM: 94854203)
Black Nylon

Front & Rear Wheel
Fender Liner Screw Grommet
#12 Screw Size
Head Diameter: 16mm
Stem Length: 19mm
Fits Into 9mm x 9mm Sq. Hole
Tacoma, T100 &
4 Runner
1992 - On
Chevrolet Nova & Prizm
And Pontiac Vibe
1985 - On

UNIT PACKAGE: 15



19676

(10277480)
Natural Nylon

License Plate Cover
Screw Grommet
M4.2 (#8) Screw Size
Head Diameter: 9/16"
Stem Length: 9/16"
Fits Into 1/4" Square Hole
Oldsmobile Intrigue
1998 - On

UNIT PACKAGE: 15



17230

(10027015)
Natural Nylon

Screw Grommet For
Engine Control Module
Overall Length: 1-3/16"
GM (All Divisions)
1977-On

UNIT PACKAGE: 10



20938

(11561655)
Black Nylon

Tail Light Grommet
With Sealer
Head Diameter: 15mm
Stem Length: 17mm
Fits Into 11mm Hole
Buick Terraza, Chevrolet
Uplander, GMC Arcadia,
Pontiac Montana SV6
And Saturn Relay
2005 - On

UNIT PACKAGE: 5

**Remember...
All Items In
This Catalog
Are Available In Bulk.
Call For A Quote**



21674

(11570830)
White Nylon

Fog Light Grommet
Head Diameter: 16mm
Stem Length: 16mm
Overall Length: 20mm
Fits Into 11mm Hole
Cadillac Escalade, Chevrolet
Avalanche, Camaro, Colorado,
Silverado & Tahoe and GMC
Canyon, Denali, Sierra & Yukon
2005 - On

UNIT PACKAGE: 15



19429

(15954398)
Rubber

Tail Light Screw Grommet
Venture, Silhouette,
Transport, S & T Trucks
1995-On

UNIT PACKAGE: 25



11865

(GM: 1255823;
Ford: 389360S)
Natural Nylon

Front End Bezel Nut
#6 or #8 Screw Size
GM 1979-On
Tail Light Nut
Ford 1981-On

UNIT PACKAGE: 50



20452

(11517873)
Natural Nylon

Screw Grommet
Use With #12 Screw
Head Size: 5/8" x 3/4"
Stem Length: 9/16"
Door Handle
Chevrolet Impala &
Monte Carlo
2000 - On

UNIT PACKAGE: 15



21428
(25704358)
White Nylon

Rear Bumper Screw Grommet
With Sealer
M6.3 (1/4" or #14) Screw Size
Head Size: 15mm x 18mm
Stem Length: 23mm
Cadillac CTS & SRX and
Pontiac Grand Prix
2004 - On

UNIT PACKAGE: 10



19435
(25526447)
Natural Nylon

Radiator Screw
Grommet
#6 Screw Size
Buick Century
1996 - 86

UNIT PACKAGE: 50



20466
(GM: 25649667;
Ford:
W705590-S300,
W710459-S300)
Natural Nylon

Screw Grommet
With Sealer
M4.2 (#8) Screw Size
Head Size: 13mm x 22mm
Stem Length: 18mm
Back Glass Moulding
& Interior Trim
Cadillac & Ford Windstar
1998 - On

UNIT PACKAGE: 15



14037
(GM: 15596280;
Chry: 6035274)
Black Nylon

Cowl Vent Nut
#6 or #8 Screw Size
GM Astro & Safari
1985-On

UNIT PACKAGE: 25



14009
(14032291)
Natural Nylon

Grille Attachment Grommet
#6 or #8 Screw Size

UNIT PACKAGE: 50



12566
(GM: 25508532;
Chry: 6032061)
Black Nylon

Grille Attaching Grommet
#6 or #8 Screw Size
GM & Chrysler
1981-On

UNIT PACKAGE: 25



12713
(GM: 10032838,
1264963;
Chry: 6031869;
AMC: 8934-201-602)
Natural Nylon

High Torque Screw Grommet
#6 Screw Size
GM, Chrysler & AMC-Renault
1978-On

UNIT PACKAGE: 25



14220
(25525798,
22537749)
Natural Nylon

Grille Retaining Grommet
#8 Screw Size
GM
1985-On

UNIT PACKAGE: 50



19733
(22603044)
Black Nylon

Front Bumper
Fascia Grommet
Assembles With
Auveco 19732
Hinged Pin Retainer
Pontiac Grand Am
1999 - On

UNIT PACKAGE: 15



10365
(1377030)
Natural Nylon

Valance Panel to Rear
Bumper Bar Grommet
#6 or #8 Screw Size
GM 1971-On

UNIT PACKAGE: 100

Inquire About Our
FasTrack Web Cost
Recovery Program
For Body Shops



19732
(22615352)
Black Nylon

Front Bumper Fascia
Hinged Pin Retainer
Assembles With
Auveco 19733 Grommet
Pontiac Grand Am
1999 - On

UNIT PACKAGE: 15

GENERAL MOTORS CLIPS & FASTENERS **Sec. 20**



20635

(GM: 22722860)
White Nylon

Trim Panel Grommet
With Sealer
Flange Diameter: 24mm
Stem Length: 12mm
Fits Into 9mm Hole
Use With Auveco 20634
Oldsmobile Alero &
Pontiac Grand Am
2002 - On

UNIT PACKAGE: 25



21518

(11561987)
Black Nylon

Tail Light Grommet
With Sealer
Head Diameter: 24mm
Stem Length: 22mm
Overall Length: 24.5mm
Cadillac Escalade and
Chevrolet Avalanche
2007 - On

UNIT PACKAGE: 15

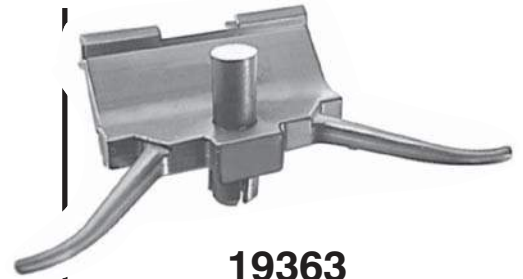

19363

(3548693)
Nylon

Front Door
Lower Moulding Clip
Cadillac Eldorado
1992-On

UNIT PACKAGE: 10



21384

(11561500)
Yellow Nylon

Trim Panel Grommet
With Sealer
Flange Diameter: 24mm
Stem Length: 12mm
Fits Into 9mm Hole
Use With Auveco #21383
Chevrolet Traverse
2010 - On

UNIT PACKAGE: 25



18977

(15690729)
Black Nylon

Front & Rear Rocker Panel
Moulding Retainer
GM Astro & Safari 1995 - On

UNIT PACKAGE: 25



17128

(10119853)
Nylon

Body Side & End Gate Lower
Moulding Clip
Olds Custom Cruiser
1991-On

UNIT PACKAGE: 25



20527

(15745990)
Black Nylon

Rear Light Housing
Lower Grommet
Head Size: 24mm x 24mm
Stem Length: 17mm
Fits Into 15mm Hole
GM Bravada, Envoy
& Trailblazer
2002 - On

UNIT PACKAGE: 15



19613

(15733971)
Black Nylon

Front Air Deflector Retainer
Small Head Dia.: 18mm
Medium Head Dia.: 26mm
Flange Dia.: 30mm
Stem Length: 24mm

Use With 19614
C & K Trucks
1999 - On

UNIT PACKAGE: 15



13925

(20338568)
Nylon

Outer Panel Front of Rear
Wheel Opening Moulding Clip
GM
1982-On

UNIT PACKAGE: 10



20529

(15745991)
Black Nylon

Rear Light Housing
Upper Grommet
Head Size: 13mm x 20mm
Stem Length: 17mm
Fits Into 9mm x 16mm Hole
GM Bravada, Envoy
& Trailblazer
2002 - On

UNIT PACKAGE: 15



19614

(15733970)
Black Nylon

Front Air Deflector
Grommet
Head Dia.: 28mm
Stem Length: 13mm

Use With 19613
C & K Trucks
1999-On

UNIT PACKAGE: 25



18911
(22578985)
Nylon

Rocker Panel
Moulding Clip
Buick Skylark 1993-On

UNIT PACKAGE: 10



Not Actual Size

19361
(25554845)
Nylon

Rocker Panel Moulding Clip
Pontiac Bonneville
1992-On

UNIT PACKAGE: 20



11485
(1729250)
Nylon

Roof Transverse Moulding Clip
GM
1976-On

UNIT PACKAGE: 25

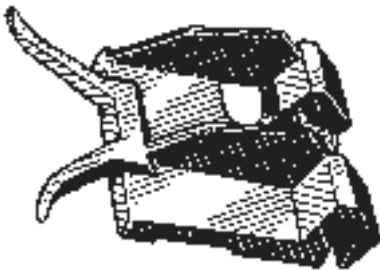

17545
(22550254)
Nylon

Rocker Panel Moulding Clip
Pontiac Grand Am SE
1992-On

UNIT PACKAGE: 25



19410
(10261327)
Nylon

Front & Rear Door
Lower Moulding Clip
Buick Century, Regal & Rendezvous
And Pontiac Aztek & Grand Prix
1997-On

UNIT PACKAGE: 15



13924
(10013153)
Nylon

Rocker Panel Moulding
To Fender Clip
GM
1981-On

UNIT PACKAGE: 10



11138
(6263345)
Nylon

Body Side Moulding Clip
Use w/ 1/8" Pop Rivet
GM Trucks
1968-On

UNIT PACKAGE: 10

**For The Most
Up-To-Date
Information
On New Items
Available
From Auveco,
Refer To The
"Hot New Items"
Section
Of The Auveco
Website
(www.auveco.com)**

GENERAL MOTORS CLIPS & FASTENERS **Sec. 20**



14215
(15597271)
Nylon

Body Side Moulding Clip
GM Vans
1985-On

UNIT PACKAGE: 25



11816
(20046150)
Nylon

Quarter Belt Moulding Clip
GM
1977-On

UNIT PACKAGE: 50



14946
(20606417)
Nylon

Left Outer Panel In Front of Rear
Wheel Opening Moulding Clip
1-3/16" Long, 7/8" Wide
Pontiac Bonneville
1989-87

UNIT PACKAGE: 25



10220
(4457595,
4457495)
Nylon

Quarter Belt & Wheel Opening
Moulding Clip
GM
1967 -On

UNIT PACKAGE: 50



11288
(9838109)
Gray Nylon

Body Side Moulding Clip
Buick, Chevrolet & Oldsmobile
1967-On

UNIT PACKAGE: 100



18118
(10135796)
Nylon

Body Side Moulding Clip
Buick Roadmaster
1991-On

UNIT PACKAGE: 15



11425
(1688094)
Nylon

Vinyl Top Clip
(Used on narrow Moulding across
top of roof)
Chevrolet, Cadillac & Oldsmobile
1974-On

UNIT PACKAGE: 50



11426
(9727078)
Nylon

Belt Moulding Clip
GM

UNIT PACKAGE: 50



11717
(1660123)
Nylon

Belt Moulding Clip
GM
1975-On

UNIT PACKAGE: 50



9850
(7731589)
Natural Nylon

Quarter Panel Reveal Moulding &
Landau Top Moulding Clip
Use With Screw 9877
GM

UNIT PACKAGE: 100



10617
(8799350)
Nylon

Door, Quarter Panel & Rear End
Moulding Clip
GM
1970-On

UNIT PACKAGE: 50



12563
(20175051,
15633873)
Nylon

Quarter Belt Reveal Moulding Clip
GM
1980-On

UNIT PACKAGE: 50



12594
(20171942)
Nylon

Moulding Clip
GM
1980-On

UNIT PACKAGE: 25



12824
(20274997)
Nylon

Rear Quarter Reveal Moulding Clip
GM
1980-On

UNIT PACKAGE: 50



13458
(20444103)
Nylon

Door Moulding Clip
GM
1984-On

UNIT PACKAGE: 15



12602
(20237057)
Nylon

Moulding Clip
GM
1980-On

UNIT PACKAGE: 25



17219
(21093588)
Nylon

Roof Drip Moulding Clip
2 Door & 4 Door Models
GM Saturn
1991-On

UNIT PACKAGE: 25



13828
(GM: 1706200)

Quarter Belt Moulding Clip
Cadillac
1976-On

UNIT PACKAGE: 25



12621
(14022878)
Nylon

Moulding Clip
GM
1980-On

UNIT PACKAGE: 25



10318
(8733059
4492962, 9838109)
Nylon

Body Side & Wheel Opening
Moulding Clip
Buick, Chevrolet & Oldsmobile
1968-On

UNIT PACKAGE: 100



20263
(22599312)
Black Nylon

Front & Rear Door
Window Moulding Clip
Chevrolet Malibu, Oldsmobile
Achieva & Cutlass
1997 - On

UNIT PACKAGE: 25



14642
(20199675)
Nylon

Quarter Belt Reveal Moulding Clip
7/16" Wide, 31/32" long
GM
1980-On

UNIT PACKAGE: 50



14033
(20393536)
Nylon

Front/Side Fender Moulding Clip
GM Truck
1983-On

UNIT PACKAGE: 25



20232
(10287926)
Yellow Nylon

Front & Rear Door
Window Moulding Clip
Overall Length: 1-9/16"
Buick Century & Regal
and Oldsmobile Intrigue
1997 - On

UNIT PACKAGE: 25

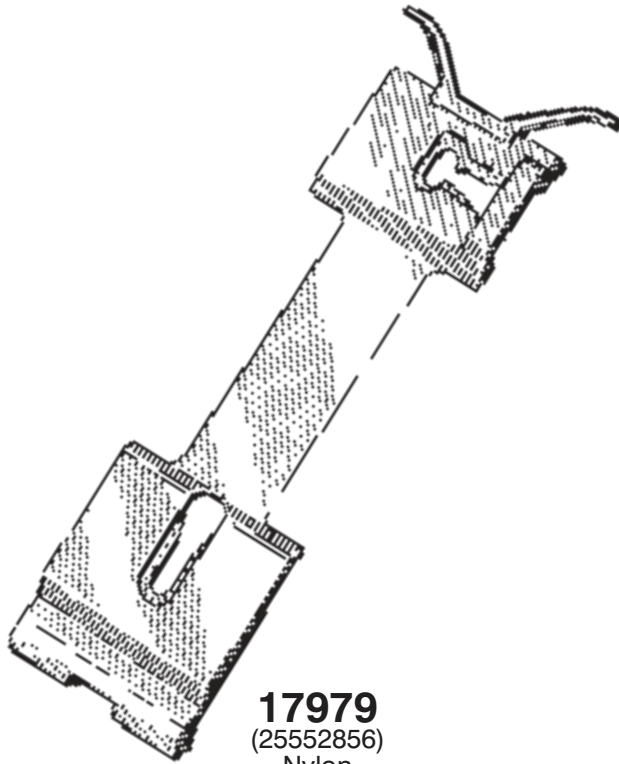

17979
(25552856)
Nylon

Front & Rear Door Center Moulding Clip
4-3/8" Long
Buick LeSabre Ltd.
1992-On

UNIT PACKAGE: 5



18417
(12519975)
Nylon

Front & Rear Door
Lower Finish Panel
(Lower) Moulding Clip
Use With 18421
Pontiac Bonneville
1992-On

UNIT PACKAGE: 15

Please
E-Mail
Your New Item Suggestions
To mail@auveco.com



20578
(GM: 88970495,88973654;
Toyota: 76924-52021)
Black Nylon

Rocker Moulding Retainer
Head Diameter: 32mm
Stem Length: 10mm
Fits Into 22mm Hole
Pontiac Vibe & Toyota Corolla
2003 - On

UNIT PACKAGE: 25



18421
(25606388)
Nylon

Front & Rear Door
Lower Finish Panel Moulding Clip
Use With 18417
Pontiac Bonneville
1992-On

UNIT PACKAGE: 25



19358
(3526573)
Nylon

Front & Rear Door
Lower Moulding Clip
Cadillac DeVille & Seville
1997-92

UNIT PACKAGE: 10



18418
(16611889)
Nylon

Front Fender, Door
& Rear Quarter Panel
Center Moulding (Lower) Clip
Pontiac Grand Prix
1991-On

UNIT PACKAGE: 10



18429
(12519972)
Nylon

Rear Door
Lower Finish Panel
Upper Moulding Clip
Pontiac Bonneville
1992-On

UNIT PACKAGE: 15

Not Actual Size



19389
(25630330)
Nylon

Front Fender and
Front & Rear Door
Upper Moulding Clip
Pontiac Bonneville
1996-On

UNIT PACKAGE: 10



19411
(25630331)
Nylon

Front Door And
Front & Rear Fender
Moulding Clip
Pontiac Bonneville
1996-On

UNIT PACKAGE: 10

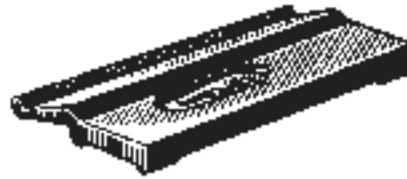

18428
(10167448)
Nylon

Rear Quarter Center Front
Moulding Clip
Olds Cutlass
(Exc. Deluxe Extra Trim)
1994-92

UNIT PACKAGE: 25

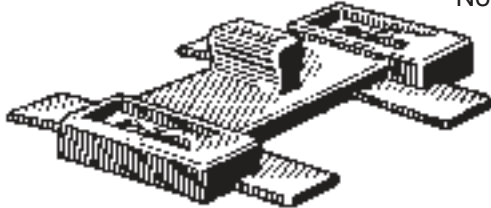

Not Actual Size

18427
(20730529)
Nylon

Front & Rear Door
Lower Finish Panel
Moulding Clip
Cadillac Seville, Olds 98
& Pontiac Bonneville
1988-On

UNIT PACKAGE: 15

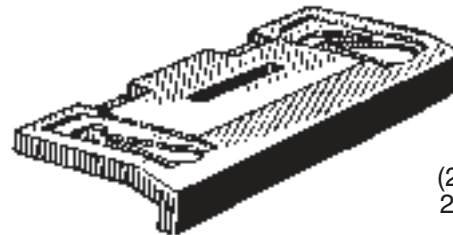

18422
(25552852,
25633289)
Nylon

Door Upper Moulding Clip
w/Deluxe Extra Trim
Pontiac Bonneville
1992-On

UNIT PACKAGE: 15



18423
(25552853)
Nylon

Door Upper Moulding Clip
Pontiac Bonneville
1992-On

UNIT PACKAGE: 15

Auveco's
FasTrack Web
Cost Recovery System
For Repair Fasteners
Ensures You
Never Lose Money
On Fasteners Again!



19357
(10167445)
Nylon

Rocker Quarter Panel
Moulding Clip
Oldsmobile Cutlass
Supreme
1997-92

UNIT PACKAGE: 15



19362
(22642199)
Nylon

Rocker Panel Moulding Clip
Oldsmobile Achieva & Cutlass
1997-On

UNIT PACKAGE: 25



19370
(16615006)
Nylon

Rocker Panel Moulding Clip
Oldsmobile Aurora
1995-On

UNIT PACKAGE: 15



20280
(25648693)
Gray Nylon

Rocker Panel
Moulding Clip
7/8" Wide
2" Long
Cadillac DeVille
& Seville
1998 - On

UNIT PACKAGE: 10



20522
(25691949, 25704001)
Black Nylon

Rocker Panel Moulding Clip
Width: 7/8", Length: 2"
Buick Park Ave.,
Cadillac DeVille & Seville
And Pontiac Bonneville
2000 - On

UNIT PACKAGE: 10



20318
(25722671)
Gray Nylon

Rocker Panel Clip
Width: 7/8"
Length: 2"
Buick LeSabre, Cadillac DeVille &
Seville, Oldsmobile Aurora and
Pontiac Bonneville
2000 - On

UNIT PACKAGE: 10

**Take The Guesswork
Out Of Identifying
Clips and Fasteners
With Auveco Display Boards**

To assist you in correctly identifying body hardware, we have the most popular items shrink-wrapped onto seven convenient, time-saving 11" wide by 14" long product display boards. The display boards show the Auveco part numbers, the O.E.M. numbers, sizes, descriptions, etc. It's all the information you need to make sure you're selecting the correct part.

Refer to the color pages at the front of the catalog for all the information on the Auveco Display Board program.



19390
(10270672)
Nylon

Rear Side Door
Lower Moulding Clip
Pontiac Trans Sport, Montana
1997-On

UNIT PACKAGE: 10



18390
(10082288)
Black Nylon

Front Door
Moulding Retainer
Chevrolet Beretta, Corsica
1987-On

UNIT PACKAGE: 25



18419
(16611887)
Nylon

Front Fender, Door
& Rear Quarter Panel
Center Moulding (Upper) Clip
Pontiac Grand Prix
1991-On

UNIT PACKAGE: 15



20408
(10287547)
White Nylon

Door & Rocker Panel
Moulding Clip
Top Head Size: 3.5mm x 8mm
Bottom Head Size: 8.7mm x 12mm
Stem Length: 8mm
Fits Into 8mm Hole
Buick Century, Regal &
Pontiac Grand Prix
1995 - On

UNIT PACKAGE: 25



21158
(11569920)
Green Nylon

Fender Moulding Clip
With Sealer
Top Head Size: 7.5mm x 11mm
Bottom Head Size: 15mm x 15mm
Stem Length: 13mm
Fits Into 7mm Hole
Buick Enclave, Cadillac CTS,
Chevrolet Traverse & GMC Acadia
2003 - On

UNIT PACKAGE: 10



15695
(Toyota: 62955-20020;
GM: 94848834)
Nylon

Retainer With Sealer
Head Dia: 15mm
Stem Length: 9mm
Fits Into 8mm Hole
Toyota Pick-Up Truck
Pontiac Vibe

UNIT PACKAGE: 25



21316
(94530742)
White Nylon

Fender, Wheel, Side & Bumper
Moulding Clip With Sealer
Top Head Size: 11mm x 15mm
Bottom Head Diameter: 16mm
Stem Length: 10mm
Fits Into 8mm Hole
Saturn Vue
2008 - On

UNIT PACKAGE: 15



21671
(11611079)
Gray Nylon

Lower Door & Fender
Moulding Clip With Sealer
Top Head Size: 7.5mm x 11mm
Bottom Head Diameter: 15mm
Stem Length: 14mm
Chevrolet Volt
2011 - On

UNIT PACKAGE: 10



21299
(94530385)
White Nylon

Rocker Panel
Moulding Clip With Sealer
Top Head Size: 12mm x 14mm
Bottom Head Size: 17.5mm x 20mm
Stem Length: 13mm
Saturn Vue
2008 - On

UNIT PACKAGE: 15



20326
(25718851)
Yellow Nylon

Door Trim Moulding Clip
Head Size: 9/16" x 3/4"
Stem Length: 3/8"
Cadillac DeVille & Seville
1998 - On

UNIT PACKAGE: 25



19757
(10431524)
Black Nylon

Rocker Panel
Moulding Clip
Head Size: 11/16" x 1-5/16"
Stem Length: 9/16"
Snaps Into 5/16" Hole
Chevrolet Impala, Lumina
& Monte Carlo
2000 - On

UNIT PACKAGE: 15

GENERAL MOTORS CLIPS & FASTENERS **Sec. 20**



19800

(10352803, 10437565)
Black Nylon

Rocker Panel Moulding Clip
Head Size: 15/32" x 1-5/16"
Stem Length: 9/16"
Snaps Into 5/16" Hole
Chevrolet Impala, Lumina & Monte Carlo
2000 - On

UNIT PACKAGE: 10



20809

(10352797)
Gray Nylon

Rocker Panel Moulding Clip
Head Size: 11/16" x 1-5/16"
Stem Length: 11/16"
Fits Into 5/16" Hole
Chevrolet Impala, Lumina & Monte Carlo
2000 - On

UNIT PACKAGE: 15



20520

(10308063)
Black Nylon

Rocker Panel Moulding Clip
Head Size: 18mm x 35mm
Stem Length: 20mm
Fits Into 10mm Hole
Buick Rendezvous & Pontiac Aztek
2001 - On

UNIT PACKAGE: 15



20810

(10431523)
Tan Nylon

Rocker Panel Moulding Clip
Head Size: 11/16" x 1-5/16"
Stem Length: 9/16"
Fits Into 5/16" Hole
Chevrolet Impala, Lumina & Monte Carlo
2000 - On

UNIT PACKAGE: 15



20808

(10352799)
Black Nylon

Rocker Panel Moulding Clip
Head Size: 11/16" x 1-5/16"
Stem Length: 11/16"
Fits Into 5/16" Hole
Chevrolet Impala, Lumina & Monte Carlo
2000 - On

UNIT PACKAGE: 15



20976

(25742293)
Blue Nylon

Rocker Panel Moulding Clip
Top Head Size: 9/16" x 25/32"
Bottom Head Size: 5/8" x 25/32"
Stem Length: 9/16"
Fits Into 3/8" Hole
Cadillac DeVille & Seville
2000 - On

UNIT PACKAGE: 15



20811

(10431526)
Red Nylon

Rocker Panel Moulding Clip
Head Size: 11/16" x 1-5/16"
Stem Length: 9/16"
Fits Into 5/16" Hole
Chevrolet Impala, Lumina & Monte Carlo
2000 - On

UNIT PACKAGE: 15



20973

(10352798)
Tan Nylon

Rocker Panel Moulding Clip
Head Size: 11/16" x 1-5/16"
Stem Length: 11/16"
Fits Into 5/16" Hole
Chevrolet Impala, Lumina & Monte Carlo
2000 - On

UNIT PACKAGE: 15



20972

(11589176)
White Nylon

Rocker Panel Moulding Clip
Top Head Size: 3/4" x 1-1/32"
Bottom Head Size: 19/32" x 1-1/32"
Stem Length: 9/16"
Fits Into 3/8" Hole
Chevrolet Malibu
2004 - On

UNIT PACKAGE: 15



20775

(10352809)
White Nylon

Rocker Panel Moulding Clip
Head Size: 11/16" x 1-5/16"
Stem Length: 11/16"
Fits Into 5/16" Hole
Chevrolet Impala, Lumina & Monte Carlo
2000 - On

UNIT PACKAGE: 15



20974

(10352804)
Maroon Nylon

Rocker Panel Moulding Clip
Head Size: 15/32" x 1-9/32"
Stem Length: 11/16"
Fits Into 5/16" Hole
Chevrolet Impala, Lumina & Monte Carlo
2000 - On

UNIT PACKAGE: 10



20865

(15221959)
Gray Nylon

Rocker Panel Moulding Clip
Width: 9/16"
Length: 1-1/8"
Stem Length: 9/16"
Fits Into 1/2" Hole
Chevrolet Cobalt & HHR
2005 - On

UNIT PACKAGE: 15



19820
(22603384)
White Nylon

Rocker Panel Moulding Clip
Head Size: 3/4" x 1-3/16"
Stem Length: 19/32"
Fits Into 7/16" Hole
Oldsmobile Alero
& Pontiac Grand Am
1999 - On

UNIT PACKAGE: 15



20952
(15236894)
White Nylon

Rocker Panel Moulding Clip
Top Head Size: 9/16" x 23/32"
Overall Height: 5/8"
Stem Length: 7/16"
Fits Into 3/8" Hole,
Buick Lucerne and
Cadillac CTS & STS
2003 - On

UNIT PACKAGE: 15



19822
(25693852)
Gray Nylon

Rocker Panel Moulding Clip
Top Head: 9/16" x 3/4"
Bottom Head: 5/8" x 3/4"
Stem Length: 9/16"
Fits Into 7/16" Hole
Buick LeSabre; Cadillac Concours,
DeVille, Eldorado & Seville;
Chevrolet Impala, Lumina & Monte
Carlo; Oldsmobile Aurora and
Pontiac Bonneville
1995 - On

UNIT PACKAGE: 25



21130
(Not Available From O.E.M.)
Black Nylon

Rocker Moulding Clip
Upper Head Size: 12mm x 20mm
Bottom Head Size: 12mm x 24mm
Stem Length: 15mm
Fits Into 9mm Hole
Saturn Aura
2007 - On

UNIT PACKAGE: 15



20377
(11518357)
White Nylon

Rocker Panel Moulding Clip
With Sealer
Top Head Size: 9/16" x 13/16"
Bottom Head Size: 13/16" x 13/16"
Stem Length: 9/16"
Fits Into 7/16" Hole
Chevrolet Avalanche
2002 - On

UNIT PACKAGE: 15



20885
(15288146, 15893516)
Gray Nylon

Windshield Pillar
Moulding Clip
Top Head Size: 12mm x 20mm
Bottom Head Size: 14mm x 20mm
Stem Length: 15mm
Fits Into 9mm Hole
Chevrolet Equinox &
Pontiac Torrent
2005 - On

UNIT PACKAGE: 15



21128
(11562563)
White Nylon

Rocker Moulding Clip
Upper Head Size: 12mm x 20mm
Bottom Head Size: 12mm x 32mm
Stem Length: 15mm
Fits Into 10mm Hole
Chevrolet Malibu
2008 - On

UNIT PACKAGE: 15



20417
(91176726)
White Nylon

Side Door, Wheel Opening
& Rocker Panel
Moulding Clip With Sealer
Top Head Size: 15/32" x 25/32"
Bottom Head Size: 9/16" x 25/32"
Stem Length: 7/16"
Fits Into 7/16" Hole
Geo Tracker 2001 - On

UNIT PACKAGE: 15



20774
(25724529)
White Nylon

Rocker Moulding & Grille
Moulding Clip
Top Head Size: 9/16" x 13/16"
Bottom Head Size: 5/8" x 13/16"
Stem Length: 9/16"
Fits Into 3/8" Hole
Buick LeSabre & Rainier;
Cadillac Concours, CTS,
DeVille, Eldorado, Escalade,
Seville, SRX & STS; Chevrolet
Avalanche, Impala, Lumina,
Monte Carlo, SSR,
Vans & Trucks; Oldsmobile
Aurora & Bravada
and Pontiac Bonneville
1992 - On

UNIT PACKAGE: 15



20607
(10323057)
White Nylon

Rocker Moulding Clip
Top Head Size: 12mm x 20mm
Bottom Head Size: 12mm x 24mm
Stem Length: 14mm
Fits Into 9mm Hole
Pontiac Grand Prix
2004 - On

UNIT PACKAGE: 15



20328
(10443956)
White Nylon

Rocker Panel
Moulding Clip
Top Head Size: 9/16" x 13/16"
Bottom Head Size: 13/16" x 13/16"
Stem Length: 9/16"
Fits Into 7/16" Hole
Chevrolet Impala, Lumina,
Monte Carlo and C & K Trucks
2000 - On

UNIT PACKAGE: 15

GENERAL MOTORS CLIPS & FASTENERS **Sec. 20**



20756
(5480852)
Yellow Nylon

Rocker Panel Moulding Clip With Sealer
Top Head Size: 9/16" x 25/32"
Bottom Head Size: 5/8" x 13/16"
Stem Length: 9/16"
Chevrolet Equinox
2005 - On

UNIT PACKAGE: 10



21156
(11570512)
Yellow Nylon

Side Window Reveal Moulding Clip With Sealer
Length: 28mm
Width: 12.5mm
Overall Height: 13mm
Fits Into 6mm Hole
Buick Lucerne
2006 - On

UNIT PACKAGE: 10



20353
(10442914)
White Nylon

Rocker Panel Moulding Clip
Top Head Size: 1/2" x 9/16"
Bottom Head Size: 9/16" x 5/8"
Stem Length: 9/16"
Fits Into 7/16" Hole
Buick Rendezvous
2002 - On

UNIT PACKAGE: 15



20934
(15127746)
White Nylon

Body Side Moulding Clip
Head Size: 12mm x 20mm
Stem Length: 11mm
Fits Into 9mm Hole
Buick Terraza, Chevrolet Uplander,
GMC Acadia, Pontiac
Montana SV6 And
Saturn Relay
2005 - On

UNIT PACKAGE: 15



21129
(11569918)
White Nylon

Roof Rail Moulding Clip With Sealer
Top Head Size: 13mm x 30mm
Stem Length: 13mm
Fits Into 7mm Hole
Buick Enclave & GMC Acadia
2007 - On

UNIT PACKAGE: 15



20617
(10242602)
Green Nylon

Wheel Opening Moulding Clip
Top Head Size: 9/16" x 13/16"
Bottom Head Size: 9/16" x 13/16"
Stem Length: 1/2"
Fits Into 7/16" Hole
Pontiac Trans Sport/ Montana
1997 - On

UNIT PACKAGE: 10



21242
(11562250)
White Nylon

Rocker Panel Moulding Clip With Sealer
Top Head Size: 12mm x 20mm
Bottom Head Size: 12mm x 20mm
Stem Length: 11mm
Fits Into 9mm Hole
GMC Acadia
2007 - On

UNIT PACKAGE: 15



20481
(10423553)
Green Nylon

Side Moulding, Fender & Rocker Panel Moulding Clip
Top Head Size: 1/2" x 13/16"
Bottom Head Size: 19/32" x 13/16"
Stem Length: 9/16"
Fits Into 7/16" Hole
Pontiac Aztek And
GM C & K Trucks
2001 - On

UNIT PACKAGE: 15



21504
(GM: 10445899)
Black Nylon

Door Moulding Clip
Top Head Size: 14mm x 20mm
Bottom Head Size: 15.5mm x 20mm
Stem Length: 14mm
Fits Into 9mm Hole
GM SUV's
1997 - On

UNIT PACKAGE: 15



21374
(11571175)
Gray Nylon

Rocker Moulding Clip With Sealer
Top Head Size: 12mm x 20mm
Bottom Head Size: 12mm x 20mm
Stem Length: 11mm
Fits Into 9mm Hole
Chevrolet Traverse
2010 - On

UNIT PACKAGE: 15



20521
(10242285,
10308019,
10297369)
Black Nylon
With Sealer

Rocker Panel Moulding Clip
Top Head Size: 15/32" x 25/32"
Bottom Head Size: 5/8" x 25/32"
Stem Length: 9/16"
Fits Into 7/16" Hole
Pontiac Aztek, Montana
& Trans Sport
1997 - On

UNIT PACKAGE: 15



19381
(10297368)
White Nylon

Rear Wheel Opening Moulding Clip
Top Head Size: 15/32" x 25/32"
Bottom Head Size: 1/2" x 25/32"
Stem Length: 9/16"
Fits Into 7/16" Hole
Pontiac Trans Sport, Montana
With Short Wheel Base
1997 - On

UNIT PACKAGE: 10



19379
(10297371)
Yellow Nylon

Rear Wheel Opening
Moulding Clip
Top Head Size: 19/32" x 25/32"
Stem Length: 9/16"
Fits Into 7/16" Hole
Pontiac Trans Sport, Montana
With Long Wheel Base
1997 - On

UNIT PACKAGE: 15



20825
(10297370)
Brown Nylon

Moulding Clip
With Sealer
Top Head Size: 12mm x 20mm
Bottom Head Size: 15mm x 20mm
Stem Length: 14mm
Fits Into 11mm Hole
Chevrolet Venture,
Oldsmobile Silhouette,
Pontiac Trans Sport
APV & Montana
And Hummer
1997 - On

UNIT PACKAGE: 15



18274
(16614134)
Nylon

Front Fender &
Door Moulding Clip
Olds Cutlass Supreme
4 Door
1992 - On

UNIT PACKAGE: 25

**Looking For A New
Fastener That's Not In The
Auveco Catalog?
Send Us An E-Mail
About It.
mail@auveco.com**



20935
(15116576,
15282120)
Green Nylon

Body Side Moulding Clip
Head Size: 16mm x 38mm
Stem Length: 15mm
Fits Into 10mm Hole
Buick Terraza, Cadillac C & K Truck,
Chevrolet C, K Truck & Uplander,
GMC Acadia, C & K Truck,
Pontiac Montana SV6
And Saturn Relay
2005 - On

UNIT PACKAGE: 15



21036
(11518988)
White Nylon

Fender, Spoiler & Roof Rack
Moulding Clip With Sealer
Top Head: 12mm x 21mm
Bottom Head: 12mm x 20mm
Stem Length: 15mm
Fits Into 9mm Hole
Buick Enclave, Chevrolet SSR, GMC
Acadia, Hummer H3, S & T Trucks
2002 - On

UNIT PACKAGE: 15



21667
(11609923)
Gray Nylon

Moulding Clip
With Sealer
Top Head Size: 12mm x 20mm
Bottom Head Size: 12mm x 24mm
Stem Length: 16mm
Chevrolet Camaro and Pontiac G6
2005 - On

UNIT PACKAGE: 15



21013
(Not Available
From O.E.M.)
Yellow Nylon

Rocker Panel
Moulding Clip
Top Head Size: 15/32" x 13/16"
Bottom Head Size:
15/32" x 25/32"
Stem Length: 9/16"
Fits Into 3/8" Hole
Hummer H3
2005 - On

UNIT PACKAGE: 15



21370
(GM: 25922739)
Green Nylon

Rocker Moulding Clip
Top Head Size: 12mm x 29mm
Bottom Head Size: 12mm x 20mm
Stem Length: 10mm
Fits Into 9mm Hole
Buick Enclave, Chevrolet Traverse
& GMC Acadia
2009 - On

UNIT PACKAGE: 25



21200
(11588818, 11561329)
Black Nylon

Front Bumper and
Rocker Moulding Clip
Top Head Size: 18mm x 26mm
Bottom Head Size: 14mm x 20mm
Stem Length: 15mm
Fits Into 10mm Hole
Cadillac STS and Corvette
2005 - On

UNIT PACKAGE: 10

GENERAL MOTORS CLIPS & FASTENERS **Sec. 20**



20951
(15236893)
Black Nylon

Rocker Panel Moulding Clip
Top Head Size: 3/4" x 1-9/16"
Overall Height: 11/16"
Stem Length: 7/16"
Fits Into 3/8" Hole
Buick Lucerne
2006 - On

UNIT PACKAGE: 15



20884
(11561491,
15872008)
Black Nylon

Rocker Panel
Moulding Clip
With Sealer
Top Head: 20mm x 30mm
Overall Length: 28mm
Fits Into 17mm Hole
Chevrolet Equinox &
Pontiac Torrent
2005 - On

UNIT PACKAGE: 10



19821
(10431761)
Gray Nylon

Rocker Panel Moulding Clip
Top Head Size: 11/16" x 1-1/2"
Bottom Head Size: 7/8 x 1-9/16"
Stem Length: 1-1/4"
Fits Into 7/16" Hole
Chevrolet Impala,
Lumina & Monte Carlo
2000 - On

UNIT PACKAGE: 15

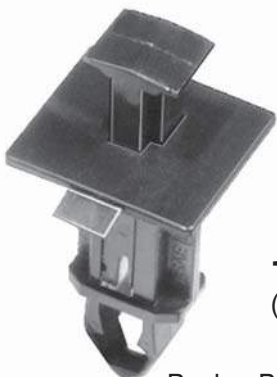

18833
(3531990)
Nylon

Rocker Panel
Push-Type
Moulding Clip
Cadillac Seville &
Touring Sedan
1994-On

UNIT PACKAGE: 5



21503
(GM: 25744385)
Green Nylon

Rocker Moulding Clip
Head Size: 22mm x 46mm
Stem Length: 17mm
Fits Into 10mm Hole
Cadillac
1998 - On

UNIT PACKAGE: 15



20950
(10384814)
White Nylon

Rocker Panel Moulding Clip
Top Head Size: 3/4" x 1-9/16"
Overall Height: 1-7/16"
Stem Length: 21/32"
Fits Into 7/16" Hole
Buick Lucerne
2006 - On

UNIT PACKAGE: 15



20868
(11589182)
Black Nylon

Rocker Panel Moulding Clip
With Sealer
Head Size: 11/16" x 2-3/16"
Stem Length: 11/16"
Fits Into 5/8" Hole
Hummer
2006 - On

UNIT PACKAGE: 10



21177
(10363352)
Black Nylon

Rocker, Pillar and Floor
Moulding Clip
Top Head Size: 18mm x 38mm
Bottom Head Size: 22mm x 40mm
Stem Length: 33mm
Fits Into 11mm Hole
Saturn Aura
2007 - On

UNIT PACKAGE: 15



20464
(10270517)
White Nylon

Rocker Panel &
Fender Flare
Moulding Clip
Overall Length: 41mm
Stem Length: 13mm
Fits Into 12mm Hole
Pontiac Trans Sport &
Montana
1997 - On

UNIT PACKAGE: 5



21161
(GM: 11569697)
Green Nylon

Side Window (Rear)
Reveal Moulding Clip
With Sealer
Flange Size: 10mm x 17mm
Stem Length: 20mm
Overall Length: 29mm
Fits Into 8mm Hole
Buick Lucerne
2006 - On

UNIT PACKAGE: 5



21375
(25774893)
Yellow Nylon

Door Moulding Clip
Top Head Size: 12mm x 16mm
Bottom Head Size: 12mm x 20mm
Stem Length: 24mm
Fits Into 9mm Hole
Chevrolet Traverse
2010 - On

UNIT PACKAGE: 15



18398
(20058837)
Nylon

Windshield Upper Garnish
Moulding Clip
GM A & G Models
1988-78

UNIT PACKAGE: 10



21157
(11610522, 10383817)
White Nylon

Side Window (Rear)
Reveal Moulding Clip
With Sealer
Top Head Size: 6mm x 11mm
Bottom Head Size: 10mm x 17mm
Stem Length: 20mm
Fits Into 8mm
Buick Lucerne
2006 - On

UNIT PACKAGE: 10



20891
(11589244,
11569973)
Yellow Nylon

Rocker Panel
Moulding Clip With Sealer
Top Head Size: 15/32" x 27/32"
Bottom Head Size:
15/32" x 25/32"
Stem Length: 1-3/8"
Fits Into 7/16" Hole
Chevrolet Equinox,
Pontiac Torrent And Trucks
2005 - On

UNIT PACKAGE: 10



17074
(20007308)
Nylon

Windshield &
Back Window
Garnish Clip
Buick Electra & LeSabre;
Cadillac DeVille & Fleetwood;
Chevrolet Caprice & Impala;
Oldsmobile 88 & 98 and
Pontiac Bonneville 1984-77

UNIT PACKAGE: 25



21335
(25775903)
Green Nylon

Rocker Moulding Clip
With Sealer
Top Head Size: 12mm x 16mm
Bottom Head Size: 12mm x 20mm
Stem Length: 24mm
Fits Into 9mm Hole
Buick Enclave, Chevrolet Traverse,
GMC Acadia & Saturn Outlook
2007 - On

UNIT PACKAGE: 10



11118
(9617200)
Nylon

Roof, Inner Side
Front, Rear &
Panel
Headlining Clip
GM 1973-On

UNIT PACKAGE: 10

11119

Same as 11118 except packing
UNIT PACKAGE: 100



17666
(20632190)
Nylon

Garnish Moulding Clip
Back Window Upper &
Side Moulding Garnish
Buick LeSabre, Cadillac Fleetwood
Brougham, Chevrolet Caprice &
Impala, Olds Delta 88 & 98,
Pontiac Bonneville & Parisienne
1989-80

UNIT PACKAGE: 10

GENERAL MOTORS CLIPS & FASTENERS **Sec. 20**



16865
(20462090)
Nylon

Garnish Moulding Clip
Buick Century & Regal, Chevrolet
Camaro, Celebrity, Monte Carlo &
Malibu, Oldsmobile Cutlass & Ciera,
Pontiac Firebird Grand Prix & 6000
1978-On

UNIT PACKAGE: 25



9477
(4490167)
Nylon

Tailgate Belt Moulding Fastener
Chevrolet El Camino

UNIT PACKAGE: 50



17233
(9662548)
Nylon

Headlining Wire Retainer Clip
Also Panel To Rear Bumper
Filler Clip
GM
1990-73

UNIT PACKAGE: 50



9965
(3944866, 1244839)

Universal Moulding Fastener
GM

UNIT PACKAGE: 25

12971

Same as 9965 except packing
UNIT PACKAGE: 10



2943
(4759145,
4761842,
4779348)

Front and Rear Fender and Door
Peak Moulding Fastener
GM

UNIT PACKAGE: 15

12966

Same as 2943 except packing

UNIT PACKAGE: 15



19602

Chevrolet Grille Bolt Kit
For installing and attaching Grille on
Chevrolet Cars.

Consists of: 50 pcs. 10-24 x 1/2"
Machine Screws
50 pcs. 10-24 Keps Nuts

UNIT PACKAGE: 50 Sets



14013
(GM: 20475949;
VW:175-853-673)
Black Nylon

Air Vent Screw
Use With **14014**

UNIT PACKAGE: 50



14953
(GM: 15679091;
Ford: N803494S)
Black Nylon

Fascia, Trim & Grille Retainer
Head Size: 15/32" x 15/32"
Stem Length: 21/32"
Fits Into 1/4" Square
Hole or Slot
GM 1994 - On
Ford 1985 - On

UNIT PACKAGE: 25



14727
(GM: 94221150;
Isuzu: 8942211500;
Nissan:
63844-D0100)
Black Nylon

Push-Type Retainer
Head Size: 14mm x 22mm
Stem Length: 9mm
Fits Into 7mm Hole
Geo Storm 1990-On

UNIT PACKAGE: 25



20892
(12337831)
Black Nylon

Front Bumper
Push-Type Retainer
Head Size: 14mm x 26mm
Stem Length: 14mm
Fits Into 8mm Hole
Pontiac G6
2005 - On

UNIT PACKAGE: 50



19433
(25618359)
Black Nylon

Front Bumper Fascia
Push-Type Retainer
Head Size: 15/32" x 7/8"
Stem Length: 15/32"
Fits Into 9/32" Hole
Buick Park Ave.
1996-92

UNIT PACKAGE: 25



14008
(14032200)
Black Nylon

Grille Attachment
Retainer
Head Size:
3/4" x 19/32"
Stem Length: 19/32"
Fits Into 5/16" Hole
GM
1981-On

UNIT PACKAGE: 25



19335

(22659122)
Black Nylon

Front Bumper Fascia
Push-Type Retainer
Head Size: 1-1/8" x 1-3/4"
Stem Length: 15/16"
Fits Into 1/2" Hole
Chevy Malibu, Olds Achieva
& Cutlass
1997 - On

UNIT PACKAGE: 10



14001

(14039420)
Black Nylon

Push-Type Retainer
Head Dia: 21/32"
Stem Length: 19/32"
Fits Into 5/16" Hole
GM (Including Saturn)

UNIT PACKAGE: 25



14697

(GM: 94198687;
Honda: 90657-SA6-0030;
Mazda: N304-13-356-A)
Black Nylon

Push-Type Retainer
Head Dia: 14mm
Stem Length: 11mm
Fits Into 7mm Hole

UNIT PACKAGE: 25



19726

(94858343)
Black Nylon

Door Trim Panel
Push-Type Retainer
Head Diameter: 14mm
Stem Length: 8mm
(Not Including The Pin)
Fits Into 6mm Hole
Geo Prizm
1998-On

UNIT PACKAGE: 15



19645

(94858864)
Gray Nylon

Door Trim Panel
Push-Type Retainer
Head Diameter: 14mm
Stem Length: 8mm
(Not Including The Pin)
Fits Into 6mm Hole
Geo Prizm
1998 - On

UNIT PACKAGE: 15



14260

(Toyota: 90467-06017;
Mazda: 9926-50-625;
GM: 20426301)
Black Nylon

Push-Type Retainer
Head Diameter: 15mm
Stem Length: 12mm
Fits Into 7mm Hole

UNIT PACKAGE: 15



19243

(GM: 30008324;
Suzuki: 09409-07325)
Black Nylon

Push-Type Retainer
Head Diameter: 16mm
Stem Length: 10mm
(Not Including The Pin)
Fits Into 9mm Hole
Front & Rear Bumper Fascia
Geo Metro 1989-On
Radiator Grille
Suzuki Esteem 1995-On

UNIT PACKAGE: 15



13457

(20451119)
Black Nylon

Front Compartment
Spare Tire Retainer
Head Diameter: 43/64"
Stem Length: 23/32"
Fits Into 5/16" Hole
GM

UNIT PACKAGE: 10



20577

(GM: 88970494,
88973676;
Toyota:
90467-07168)
Black Nylon

Rocker Panel & Garnish Moulding
Push-Type Retainer
Head Diameter: 20mm
Stem Length: 8mm
Fits Into 7mm Hole
Pontiac Vibe 2003 - On
Lexus & Toyota
2000 - On

UNIT PACKAGE: 15



19140

(Acura:
90505-SL0-003;
GM: 94852368;
Mitsubishi:
MB888869; Toyota:
90467-08155)
Black Nylon

Push-Type Retainer
Head Diameter: 20mm
Stem Length: 21mm
Fits Into 8mm Hole
Acura, Dodge Avenger,
Eagle Talon, Geo Prizm
Mitsubishi Eclipse & Galant
and Toyota
1993-On

UNIT PACKAGE: 5



19242

(15672149)
Black Nylon

Air Inlet Grille Panel
Push-Type Retainer
Head Dia. 13/32"
Stem Length: 11/16"
Fits Into 7/32" Hole
GM Jimmy, Blazer, S-10
& Bravada
1994-On

UNIT PACKAGE: 25



17214

(GM: 10089262,
21042098;
Chry: 55075139)
Black Nylon

Push-Type Retainer
Head Dia: 11mm (7/16")
Stem Length: 18mm (11/16")
Fits Into 6mm (15/64") Hole
GM & Saturn 4 Door
& Station Wagon
1987-On

UNIT PACKAGE: 25

14987

Same As 17214 Except Packing

UNIT PACKAGE: 50



14990

(22538102)
Black Nylon

Push-Type Retainer
Head Diameter: 7/16"
Stem Length: 15/32"
Fits Into 15/64" Hole
GM
1987 - On

UNIT PACKAGE: 50



19788

(10246149; 22657634)
Black Nylon

Rocker Panel
Push-Type Retainer
Head Diameter: 11mm
Stem Length: 20mm
Fits Into 6mm Hole
Achieva, Cutlass,
Grand Am & Malibu
1999 - On

UNIT PACKAGE: 25



19787

(22657634)
Black Nylon

Fender & Rocker Panel
Push-Type Retainer
Head Diameter: 12mm
Stem Length: 17mm
Fits Into 6mm Hole
Achieva, Cutlass,
Grand Am & Malibu
1999 - On

UNIT PACKAGE: 25



14995

(GM: 10195515,
Ford: N805026S;
Chrys: 4696488,
6503163)
Black Nylon

Push-Type Retainer
Head Diameter: 1/2"
Stem Length: 1-13/64"
Fits Into 9/32" Hole
GM, Ford & Chrysler
1987 - On

UNIT PACKAGE: 25



21595

(Not Available
From O.E.M.)
Natural Nylon

General Purpose
Push-Type Retainer
Head Diameter: 12.7mm (1/2")
Stem Length: 31mm (1-7/32")
Fits Into 7mm (9/32") Hole
Universal

UNIT PACKAGE: 50



16859

(Nissan: 66860-01W01;
GM: 94051993)
Black Nylon

Cowl Panel To
Reinforcement Plate & Engine
Splash Shield Retainer
Head Dia: 14mm (9/16")
Stem Length: 16mm (5/8")
Fits Into 6mm (1/4") Hole
Nissan 1980-On
Geo Storm 1990-On

UNIT PACKAGE: 25



20943

(15014352)
Black Nylon

Cowl Vent
Push-Type Retainer
Head Diameter: 14mm
Stem Length: 23mm
Fits Into 7mm Hole
Buick Lucerne
2006 - On

UNIT PACKAGE: 15



21112

(94530438)
Black Nylon

Fender Liner
Push-Type Retainer
Head Diameter: 15mm
Stem Length: 14mm
Fits Into 6mm Hole
Chevrolet Aveo
2004 - On

UNIT PACKAGE: 25



14997

(10053182)
Black Nylon

Push-Type Retainer
Head Diameter: 19/32"
Stem Length: 13/16"
Fits Into 5/16" Hole
GM 1987 - On

UNIT PACKAGE: 25



14991

(GM: 10139822;
25680782;
Ford: N808147S)
Black Nylon

Push-Type Retainer
Head Diameter: 11/16"
Stem Length: 11/16"
Fits Into 1/4" Hole
GM & Ford 1987 - On

UNIT PACKAGE: 25



14753

(GM: 15773445, 20452072,
20664092;
Ford: N804570S;
Chrys: 4638136)
Black Nylon

Radiator Shroud &
Trim Retainer
Head Dia: 11/16"
Stem Length: 7/8"
Fits Into 1/4" Hole
GM 1982-On
Ford 1986-On
Chrysler 1998 - On

UNIT PACKAGE: 25



14993
(22538004)
Black Nylon

Push-Type Retainer
Head Diameter: 11/16"
Stem Length: 7/8"
Fits Into 1/4" Hole
GM
1987 - On

UNIT PACKAGE: 25



20265
(25663903)
Black Nylon

Radiator Support Sight Shield
Push-Type Retainer
Head Diameter: 1"
Stem Length: 1"
Fits Into 1/4" Hole
Cadillac DeVille & Seville
1998 - On

UNIT PACKAGE: 10



11854
(14005089)
Natural Nylon

Air Conditioning Vent & General
Purpose Push-Type Retainer
Head Diameter: 7/16"
Stem Length: 9/32"
Fits Into 3/16" Hole
GM
1979 - On

UNIT PACKAGE: 25



16835
(GM: 10140480;
Chry: 6502625)
Black Nylon

Rear Bumper
Fascia Retainer
Head Dia: 21mm (27/32")
Shoulder Length: 3mm (1/8")
Stem Length: 25mm (1")
Fits Into 12mm (1/2") Hole
APV Vans
1990-On

UNIT PACKAGE: 25



17227
(21077405)
Black Nylon

Door Handle To Door
Hardware Attachment
Push-Type Retainer
Head Diameter: 7mm
Stem Length: 10mm
Fits Into 5mm Hole
2 Door & 4 Door Models
GM Saturn 1991-On

UNIT PACKAGE: 25



18933
(15676045)
Black Nylon

Rear Window
Wiper Motor Cover
& Dash Board
Push-Type Retainer
Head Diameter: 7/16"
Stem Length: 1/2"
Fits Into 1/4" Hole
GM Trucks C & K, 1, 2
1991 - On

UNIT PACKAGE: 25



21246
(22690838)
Black Nylon

Door Trim
Push-Type Retainer
Head Diameter: 12mm
Stem Length: 14mm
(Excluding The Pin)
Fits Into 6mm Hole
Chevrolet Malibu & Pontiac G6
2004 - On

UNIT PACKAGE: 25



14998
(15672330,
15956470)
Black Nylon

Push-Type Retainer
Head Diameter: 27/32"
Stem Length: 1"
Fits Into 13/32" Hole
GM
1987 - On

UNIT PACKAGE: 25



17383
(GM: 94847334,
96057847;
Toyota: 90467-07066;
Suzuki: 09409-07313)
Black Nylon

Radiator Grille
& Trim Panel
Push-Type Retainer
Head Diameter: 11mm
Stem Length: 14mm (Exc. Pin)
Fits Into 7mm Hole
Geo Tracker & Prizm
1992-89

UNIT PACKAGE: 10



20666
(22677979, 22677980)
Gray Nylon

Door Trim
Push-Type Retainer
Head Diameter: 12mm
Stem Length: 14mm (Exc. Pin)
Fits Into 6mm Hole
Chevrolet Malibu
2004 - On

UNIT PACKAGE: 25

GENERAL MOTORS CLIPS & FASTENERS **Sec. 20**



17162

(GM: 96057846;
Toyota: 90467-07041)
Black Nylon

Push-Type Retainer
Head Diameter: 15mm
Stem Length: 8mm (Exc. Pin)
Fits Into 6.3mm Hole
Geo Metro & Tracker
1989-On

UNIT PACKAGE: 10



19297

(11517824,
21035345)
Black Nylon

Liftgate Upper Window
& Lower Garnish Moulding
Push-Type Retainer
Head Diameter: 16mm
Stem Length: (Exc. Pin): 12mm
Fits Into 7mm Hole
GM Saturn
1998 - 93

UNIT PACKAGE: 15



11699

(GM: 472434;
Chry: 6031390)
Black Nylon

Cowl Ledge
Weatherstrip & Fender Liner
Push-Type Retainer
Head Dia: 11/16"
Stem Length: 5/8"
Fits Into 1/4" Hole
GM 1970-On
Chrysler 1968-On

UNIT PACKAGE: 50



19892

(25695687)
Black Nylon

Radiator Support
Sight Shield
Push-Type Retainer
Head Diameter: 27mm
Shoulder Length: 7mm
Stem Length: 18mm
Fits Into 10mm Hole
Cadillac DeVille & Seville
2000 - On

UNIT PACKAGE: 15



14011

(14019226,
14071289)
Black Nylon

Radiator Overflow
Bottle/Windshield
Washer Bottle Retainer
Head Dia: 21/32"
Stem Length: 9/16"
Fits Into 5/16" Hole
GM
1981-On

UNIT PACKAGE: 25



12567

(GM: 14019205,
14019206, 16514113;
Chry: 34201621, 6504090)
Black Nylon

Front Fender Mud Skirt
& Fender Liner
Push-Type Retainer
Head Dia: 11/16"
Stem Length: 9/16"
Fits Into 1/4" Hole
GM
1981 - On

UNIT PACKAGE: 25

14007

Same As 12567 Except Packing

UNIT PACKAGE: 50



21238

(22718369)
Black Nylon

Fuel Tank Shield & Miscellaneous
Push-Type Retainer
Head Diameter: 26mm
Stem Length: 12mm
Fits Into 10mm Hole
Chevrolet Malibu & Trail Blazer
2004 - On

UNIT PACKAGE: 25



19847

(5973823)
Blue Nylon

Fascia Retainer
Head Dia: 7/8"
Shoulder Length: 5/32"
Stem Length: 25/32"
Fits Into 1/2" Hole
GM
1979-On

UNIT PACKAGE: 25



14010

(GM: 14045480;
Chry: 6508746-AA)
Black Nylon

Fascia Retainer
Head Dia: 1"
Stem Length: 23/32"
Fits Into 3/8" Hole
GM 1982-On
Chrysler
2009 - On

UNIT PACKAGE: 25



12757

(5973400)
Black Nylon

Fascia Retainer
Head Dia: 1"
Shoulder Length: 1/8"
Stem Length: 3/4"
Fits Into 1/2" Hole
GM
1979-On

UNIT PACKAGE: 15

16265

Same as 12757 except packing

UNIT PACKAGE: 50



12756
(5973996)
Brown Nylon

Fascia Retainer
Head Dia: 1"
Shoulder Length: 1/4"
Stem Length: 7/8"
Fits Into 1/2" Hole
GM
1982-On

UNIT PACKAGE: 15



19522
(22644361)
Black Nylon

Door Sill Trim Plate
Push-Type Retainer
Head Diameter: 12mm
Stem Length: 18mm
Fits Into 6mm Square Hole
Chev. Malibu, Olds Achieva &
Cutlass
1997 - On

UNIT PACKAGE: 15



17222
(GM: 11561878,
21075686;
Ford: F3LY-14570-B)
Black Nylon

Push-Type Retainer
Head Diameter: 15mm
Stem Length: 20mm
Fits Into 8mm Hole
Rocker Panel, Wheel Liner
& Air Inlet Duct Applications
GM Saturn
2 Door & 4 Door Models
1991-On
Ford

UNIT PACKAGE: 25



19854
(21097229)
Black Nylon

Door Handle
Push-Type Retainer
Head Diameter: 7mm
Stem Length: 10mm
Fits Into 5mm Hole
Saturn 2 Door & 4 Door
1999 - On

UNIT PACKAGE: 25



17106
(GM: 22566221;
Chry: 6501577)
Black Nylon

Headlight Door Push-Type Retainer
Large Head Dia: 1/2"
Stem Length: 7/16"
Fits Into 3/16" Hole
GM Blazer & Suburban 1991 - On
Chrysler New Yorker
Landau & 5th Avenue 1988 - On

UNIT PACKAGE: 50



17103
(GM: 15681408;
Ford: N803709S)
Black Nylon

Fascia Retainer
Head Dia: 15mm
Stem Length: 23mm
Fits Into 6mm Hole
GM & Ford
1986-On

UNIT PACKAGE: 50



14016
(GM: 16500308;
Chry: 6500787)
Black Nylon

Tail Light Retainer
Large Head Diameter: 3/8"
Stem Length: 7/16"
Fits Into 3/16" Hole
GM & Chrysler

UNIT PACKAGE: 25



19355
(15960621)
Black Nylon

Rear Door
Radio Speaker
Push-Type Retainer
Head Diameter: 17/32"
Stem Length: 1-5/64"
Fits Into 1/4" Hole
GM Trucks C & K 1, 2
1995 - On

UNIT PACKAGE: 25



17226
(10207146, 21077323)
Black Nylon

Rear Door Rocker Panel
To Underbody Bracket
Push-Type Retainer
Head Diameter: 15mm
Stem Length: 29mm
Fits Into 8mm Hole
GM Saturn
4 Door Models
1991 - On

UNIT PACKAGE: 25



13999
(20363491)
Black Nylon

Body Side Moulding
Push-Type Retainer
Large Head Diameter: 3/8"
Stem Length: 1/2"
Fits Into 7/32" Hole
GM
1979-On

UNIT PACKAGE: 25



16816
(21047094)
Black Nylon

Push-Type Retainer
Large Head Dia: 14mm
Stem Length: 14mm
Fits Into 6mm Hole
GM Saturn
1991 - On

UNIT PACKAGE: 25

**Inquire About Our
FasTrack Web
Cost Recovery Program
For Body Shops**

GENERAL MOTORS CLIPS & FASTENERS **Sec. 20**



19801

(GM: 21077123;
Chrys: 6509103AA
Ford: W705436-S300)
Black Nylon

Wheel Opening Moulding
Push-Type Retainer
Head Diameter: 19/32" (15mm)
Stem Length: 3/4" (19mm)
Fits Into 1/4" (6mm) Hole
Saturn
1991 - On
Ford 2002 - On
Chrysler 2010 - On
UNIT PACKAGE: 25



16624

(1636632, 20687704)
Black Nylon

Front Bumper
Fascia Retainer
Head Dia: 17mm
Shoulder Length: 2mm
Stem Length: 18mm
Fits Into 9.5mm (3/8") Hole
Buick Riviera/Reatta
1988-On
UNIT PACKAGE: 25



13996

(20452072, 20590899)
Black Nylon

Exterior Body Retainer
Head Dia: 11/16"
Stem Length: 7/8"
Fits Into 9/32" Hole
GM 1984-On
UNIT PACKAGE: 25



20869

(GM: 88970767;
Toyota: 90467-10183)
Black Nylon

Front Fender Liner
Push-Type Retainer
Head Diameter: 18mm
Stem Length: 7.5mm Hole
Fits Into 7mm Hole
Pontiac Vibe, Lexus and
Toyota
1999 - On
UNIT PACKAGE: 10



20542

(15994165)
Black Nylon

Bumper & Rear
Wheel Apron
Push-Type Retainer
Head Diameter: 16.5mm
Stem Length: 27mm
Fits Into 8mm Hole
Saturn L Series
2000 - On
UNIT PACKAGE: 25



18030

(Chry: 6501925;
GM: 10134407)
Black Nylon

Push-Type Retainer
Head Size: 11/16"
Stem Length: 13/16"
Fits Into 1/4" Hole
Chrysler Concorde & LHS
Dodge Intrepid & Eagle Vision
1993-On
Coolant Recovery Reservoir
GM 1992-On
UNIT PACKAGE: 25



20365

(10301966, 10425306)
Black Nylon

Cowl Vent
Push-Type Retainer
Head Diameter: 18mm
Stem Length: 13mm
Fits Into 7.5mm Square Hole
Pontiac Aztek
2001 - On
UNIT PACKAGE: 10



19639

(GM: 15149708;
Chrys: 6506008AA)
Black Nylon

Radiator, Wheelhouse,
Fender & Front Bumper Cover
Push-Type Retainer
Head Diameter: 17mm
Stem Length: 16mm
Fits Into 6mm Hole
GM C & K Trucks 1999 - On
Jeep Liberty 2002 - On
UNIT PACKAGE: 25



13993

(GM:20510029;
Ford: N803362-S;
Chry: 34202672)
Black Nylon

Body Retainer
Head Dia: 11/16"
Stem Length: 7/8"
Fits Into 1/4" Hole
Ford, GM & Chrysler
1984 - On
UNIT PACKAGE: 25



20988

(GM: 11589289;
Chrysler: 6508863-AA)
Black Nylon

Air Distributor &
Windshield Defroster
Push-Type Retainer
Head Diameter: 18mm
Stem Length: 17.5mm
Panel Range: 2.0mm - 4.5mm
Fits Into 6.5mm Hole
Buick Enclave, Chevrolet Equinox,
Chevrolet & GMC
S & T Trucks, GMC Acadia
And Pontiac Torrent
2002 - On
UNIT PACKAGE: 25

Sec. 20**GENERAL MOTORS CLIPS & FASTENERS****20888**(GM: 11561368;
Chrys: 6508712AA)
Black NylonFender, Wheel & Bumper
Push-Type Retainer
Head Diameter: 18mm
Stem Length: 20mm
Panel Range: 3.0mm - 5.8mm
Fits Into 9.5mm Hole
Chevrolet Impala &
Monte Carlo
And Pontiac Grand Prix
& Solstice
2004 - On
Jeep Wrangler
2000 - On

UNIT PACKAGE: 25

**20989**(GM: 11589291;
Ford: W713331-S300)
Black NylonAir Dam & Grille
Push-Type Retainer
Head Diameter: 18mm
Stem Length: 22mm
Panel Range:
7.0mm - 9.5mm
Fits Into 6.5mm Hole
Cadillac CTS, SRX
And STS
2003 - ON

UNIT PACKAGE: 25

**20359**(11519444)
Black NylonBumper Cover
Push-Type Retainer
Head Diameter: 18mm
Stem Length: 26mm
Fits Into 10mm Hole
Oldsmobile Intrigue, Pontiac
Aztek & Grand Prix
1997 - On

UNIT PACKAGE: 25

**20880**(11589290)
Black NylonAir Inlet Grille,
Bumper Fascia &
Front Brake Caliper
Cooling Duct
Push-Type Retainer
Head Diameter: 18mm
Stem Length: 20mm
Panel Range: 4.5mm - 7.0mm
Fits Into 6.5mm Hole
Buick Enclave, Cadillac
CTS & STS, Chevrolet
Cobalt, Equinox & SSR,
GM Trucks and Pontiac
G5 & Torrent
2002 - On

UNIT PACKAGE: 50

**21529**(95230842)
Black NylonCowl Vent
Push-Type Retainer
With Sealer
Head Diameter: 18mm
Stem Length: 22mm
Fits Into 6.5mm Hole
Chevrolet Cruze
2011 - On

UNIT PACKAGE: 15

**20631**(11588988)
Black NylonFront Bumper Cover
Push-Type Retainer
Head Diameter: 18mm
Stem Length: 26mm
Fits Into 10mm Hole
Pontiac Grand Prix
2004 - On

UNIT PACKAGE: 25

**20826**(11609417)
Black NylonFender Apron
Push-Type Retainer
Head Diameter: 19mm
Stem Length: 14mm
Panel Range: 2.7mm - 5.3mm
Fits Into 8.5mm Hole
Buick Enclave & LaCrosse, Cadillac
CTS, SRX & STS, Chevrolet
Cobalt, Equinox
& Malibu, GM Trucks and
Pontiac G5, G6 & Torrent
2003 - On

UNIT PACKAGE: 50

**21672**(11611110)
Black NylonCowl Vent
Push-Type Retainer
With Sealer
Head Diameter: 18mm
Stem Length: 20mm
Fits Into 6.3mm Hole
Buick Allure & LaCrosse
and Chevrolet Volt
2010 - On

UNIT PACKAGE: 15

**16622**(10157900,
11517803,
15993201)
Black NylonFront Bumper
Fascia Retainer
Head Dia: 18mm
Stem Length: 23mm
Fits Into 9.5mm (3/8") Hole
Olds Cutlass 1990-On
GM Lt. Truck
1996 - On

UNIT PACKAGE: 25

**20990**(GM: 15296830;
Chrysler:
5116530-AA)
Black NylonFascia & General
Purpose
Push-Type Retainer
Head Diameter: 19mm
Stem Length: 16mm
Panel Range: 5.0mm - 7.0mm
Fits Into 8mm Hole
GM 2007 - On

UNIT PACKAGE: 25

GENERAL MOTORS CLIPS & FASTENERS **Sec. 20**



18308

(3540858)
Black Nylon

Radiator Air Baffle
Push-Type Retainer
Large Head Diameter: 3/4"
Stem Length: 1-1/8"
Fits Into 1/4" Hole
Cadillac Eldorado
& Seville 1993-On

UNIT PACKAGE: 25



16625

(10108746)
Black Nylon

Front Bumper
Fascia Retainer
Head Dia: 20mm
Stem Length: 20mm
Fits Into 10mm Hole
GM Station Wagons
1991-On

UNIT PACKAGE: 25



20889

(GM: 11589293
Ford: W712196-S300)
Black Nylon

Cowl Vent & Fender
Push-Type Retainer
Head Diameter: 20mm
Stem Length: 22mm
Panel Range: 4.5mm - 7.0mm
Fits Into 8.5mm Hole
Buick Century, LaCrosse
& Regal, Cadillac,
Chevrolet Equinox,
GM Trucks, Hummer H3
And Pontiac Grand Prix & Torrent
1997 - On
Ford 2006 - On

UNIT PACKAGE: 25



19239

(GM: 11519949;
Honda: 91512-SX0-003;
Mitsubishi: MU000319)
Black Nylon

Fender, Interior Trim
& Washer Tank
Push-Type Retainer
Head Diameter: 20mm
Stem Length: 11mm
Fits Into 8mm Hole
Buick, Cadillac, Chevrolet & GMC
1997 - On

UNIT PACKAGE: 25



20991

(11589292)
Black Nylon

Bumper Fascia,
Flares & Air Dam
Push-Type Retainer
Head Diameter: 20mm
Stem Length: 20mm
Panel Range: 2.0mm - 4.5mm
Fits Into 8.5mm Hole
Chevrolet & GMC
C & K Trucks
2007 - On

UNIT PACKAGE: 25



20992

(11589294)
Black Nylon

Bumper Fascia, Fender
And Toe/Floor Panel
Push-Type Retainer
Head Diameter: 20mm
Stem Length: 24mm
Panel Range: 7.0mm - 10.0mm
Fits Into 8.5mm Hole
Buick Enclave & LaCrosse,
Chevrolet & GMC
C & K Trucks, GMC Acadia,
Hummer H3 and Saturn Outlook
2005 - On

UNIT PACKAGE: 25



17216

(GM: 21030249;
Ford: N807389S;
Chry: 6503598)
Black Nylon

Air Baffle To
Under Carriage
Push-Type Retainer
Head Diameter: 20mm
Stem Length: 20mm
Fits Into 8mm Hole
GM Saturn
2 Door & 4 Door Models
1991 - On

UNIT PACKAGE: 25



19615

(15153415)
Black Nylon

Rear Bumper Cover
Push-Type Retainer
Large Head Dia.: 20mm
Stem Length: 21mm
Fits Into 9mm Hole
C & K Trucks
1999 - On

UNIT PACKAGE: 25



20632

(GM: 11518017)
Ford: W708530-S300)
Black Nylon

Bumper Cover &
Fender Shield
Push-Type Retainer
Head Diameter: 20mm
Stem Length: 26mm
Fits Into 8mm Hole
GM & Ford
1997 - On

UNIT PACKAGE: 15



18896
(21095797)
Black Nylon

Bumper Fascia
Push-Type Retainer
Large Head Dia.: 20mm
Stem Length: 28mm
Fits Into 8mm Hole
GM Saturn
1996 - On

UNIT PACKAGE: 25



15043
(14103461)
Black Nylon

Bumper Fascia Retainer
Head Dia.: 7/8"
Shoulder Length: 5/32"
Stem Length: 1-3/64"
Fits Into 1/2" Hole
GM 1987 - On

UNIT PACKAGE: 25



14020
(GM: 14093088;
Ford: N802781-S)
Black Nylon

Splash Shield & Fascia Retainer
Head Dia: 1
Stem Length: 7/8"
Fits Into 1/4" Hole
GM
1979 - On

UNIT PACKAGE: 25



20337
(24576759)
Black Nylon

Radiator Air Baffle
& General Purpose
Push-Type Retainer
Large Head Dia.: 20mm
Stem Length: 39mm
Fits Into 6mm Hole
Chevrolet Malibu,
Oldsmobile
Alero & Cutlass
And Pontiac Grand Am
1999 - On

UNIT PACKAGE: 15



20993
(GM: 11589295;
Ford: W712665-S300)
Black Nylon

Fender, Flare, Gas Tank
& Panel Attachment
Push-Type Retainer
Head Diameter: 25mm
Stem Length: 20mm
Panel Range: 3.0mm-6.0mm
Fits Into 10.5mm Hole
Chevrolet Cobalt & HHR,
GM C & K Trucks and
Pontiac G5
2005 - On

UNIT PACKAGE: 25



14147
(20547865)
Black Nylon

Body Retainer
Head Dia: 1"
Stem Length: 7/8"
Fits Into 1/4" Hole
GM
1984-On

UNIT PACKAGE: 25



20863
(5480772)
Black Nylon

Lower Rocker Moulding
Push-Type Retainer
Head Diameter: 22mm
Stem Length: 13mm
Fits Into 15mm Hole
Chevrolet Equinox
2005 - On

UNIT PACKAGE: 10



20994
(GM: 11589296)
Black Nylon

Panel Attachment
& General Purpose
Push-Type Retainer
Head Diameter: 25mm
Stem Length: 23mm
Panel Range: 6.0mm - 9.0mm
Fits Into 10.5mm Hole
Buick Enclave and
GMC Acadia
2007 - On

UNIT PACKAGE: 25



13994
(GM: 20570245, 20635065
Ford: N804614S)
Black Nylon

Splash Shield, Seat Cushion &
Spare Tire Retainer
Head Dia: 1"
Stem Length: 7/8"
Fits Into 5/16" Hole
GM
1984-On

UNIT PACKAGE: 25

Auveco...
The World's Largest
Supplier Of Body
Hardware & Specialty
Fasteners

GENERAL MOTORS CLIPS & FASTENERS **Sec. 20**



18310
(22587036)
Black Nylon

Rear Bumper Fascia
Push-Type Retainer
Head Diameter: 1"
Stem Length: 15/16"
Fits Into 3/8" Hole
Chevrolet Cavalier
& Pontiac Sunfire
1995 - On

UNIT PACKAGE: 25



15045
(10053388,
22542705)
Black Nylon

Bumper Fascia
Retainer
Head Dia: 1"
Shoulder Length: 1/8"
Stem Length: 1-7/64"
Fits Into 1/2" Hole
GM
1987-On

UNIT PACKAGE: 25



18268
(15959832)
Black Nylon

Front License
Plate Bracket
Push-Type Retainer
Head Diameter: 1"
Shoulder Length: 9/64"
Stem Length: 1-5/8"
Fits Into 1/2" Hole
GM Truck
1994-On

UNIT PACKAGE: 5



15702
(14101262)
Black Nylon

Plastic Cover On Eng.
Compartment Retainer
Head Dia: 1"
Shoulder Length: 1/8"
Stem Length: 15/16"
Fits Into 1/2" Hole
Buick, Olds & Pontiac
1988 - On

UNIT PACKAGE: 25



15042
(10077283)
Black Nylon

Bumper Fascia Retainer
Head Dia: 1"
Shoulder Length: 1/4"
Stem Length: 1-1/8"
Fits Into 1/2" Hole
GM
1982-On

UNIT PACKAGE: 25



18334
(15959833)
Gray Nylon

Front License Plate
Bracket Push-Type
Retainer
Head Diameter: 1"
Stem Length: 1-3/4"
Fits Into 1/2" Hole
GM S-10 Truck
With Decor Package
1994-On

UNIT PACKAGE: 5



15044
(22535007)
Black Nylon

Bumper Fascia Retainer
Head Dia: 1"
Shoulder Length: 1/8"
Stem Length: 1"
Fits Into 1/2" Hole
GM
1987 - On

UNIT PACKAGE: 25



21361
(GM: 11561874;
Nissan: 622A2-9E000A)
Black Nylon

Bumper Cover
Push-Type Retainer
Head Diameter: 25mm
Stem Length: 29mm
Fits Into 7mm Hole
Chevrolet Malibu, Pontiac G6
and Saturn Aura
2007 - On
Nissan Altima
1997 - On

UNIT PACKAGE: 15



17616
(21077131)
Black Nylon

Bumper Fascia
Push-Type Retainer
Head Dia: 1-3/16"
Stem Length: 2"
Fits Into 7/16" Hole
GM Saturn
1991-On

UNIT PACKAGE: 10



21176
(10382313)
Black Nylon

Sight Shield & Trim
Push-Type Retainer
Head Diameter: 24.5mm
Stem Length: 13mm
Fits Into 9mm Hole
Cadillac STS, Pontiac Solstice
and Saturn Sky
2005 - On

UNIT PACKAGE: 10



21400
(10426555)
Natural Nylon

Front Bumper
Push-Type Retainer
Top Head Diameter: 24.5mm
Bottom Head Diameter: 23.5mm
Stem Length: 36mm
Fits Into 10mm Hole
Buick Allure & LaCrosse,
Chevrolet Impala & Monte Carlo
and Pontiac Grand Prix
2000 - On

UNIT PACKAGE: 15



19417
(Chrys: 6503819,
6503401;
GM: 25631448)
Black Nylon

M7.5 x 35mm
Square Drive Truss Head
22mm Head Diameter
9mm Shoulder Diameter
Foam To Bumper Fascia
Chrysler
1993 - On
GM
1997 - On

UNIT PACKAGE: 15



20163
(25099299)
Black Nylon

Radiator Sight Shield
& Air Filter Housing
Push-Type Retainer
Head Diameter: 12.5mm
Stem Length: 17mm
Fits Into 6mm Hole
1994 - On

UNIT PACKAGE: 15



21517
(25705182)
Black Nylon

Bumper Fascia
Nylon Screw
M9.5 x 46mm
Head Diameter: 22mm
Square Drive
Cadillac Escalade & XLR,
Chevrolet Avalanche & Tahoe
and GMC Suburban, Yukon &
Yukon Denali
2004 - On

UNIT PACKAGE: 25



18353
(15960325)
White Nylon

Door Trim Panel
Push-Type Retainer
Head Dia: 9/16"
Stem length: 41/64"
Fits Into 1/4" Hole
GM Trucks C, K, 1, 2, 3
1995-On

UNIT PACKAGE: 50



20244
(25707329)
Green Nylon

Push-Type Retainer
With Sealer
Head Diameter: 19mm
Stem Length: 32mm
Fits Into 8mm Hole
Buick LeSabre, Oldsmobile Aurora
& Pontiac Bonneville
2000 - On

UNIT PACKAGE: 10

**Please E-mail
Your New Item
Suggestions
To mail@auveco.com**



20970
(Not Available From O.E.M.)
Black Nylon

M14 x 34mm
Bumper and Door Insulator
Nylon Screw
22mm Head O.D.
No. 3 Square Drive
Fits Into 12mm Hole
GM, Ford & Chrysler
2005 - On

UNIT PACKAGE: 25



19387
(15989487)
Nylon

Front & Rear Door
Trim Panel Retainer
Astro & Safari Mini-Van,
S & T Trucks
1996-On

UNIT PACKAGE: 10



13860
(20478294)
Black Nylon

Carpet Retainer
Head Dia: 30mm
Fits Onto 6mm Stud
GM 1984-On

UNIT PACKAGE: 25



18691
(10186453)
Black Nylon

Dash Sound
Barrier Retainer
Flange Dia: 30mm
Overall Length: 52mm
Chevrolet Lumina APV,
Olds Silhouette And
Pontiac Trans Sport
1990-On

UNIT PACKAGE: 25



16953
(12337900,
14103435)
Nylon

Upper Radiator
Shield Retainer
Chevrolet Corsica
& Beretta
1987-On

UNIT PACKAGE: 10



21164
(11610049)
Black Nylon

Bumper Cover Turn &
Lock Retainer
Overall Length: 24.5mm
Buick Enclave, Cadillac Escalade,
Chevrolet Suburban & Traverse
and GMC Acadia & Yukon
2007 - On

UNIT PACKAGE: 25



19472
(GM: 25535963;
Ford: N811772S)
Nylon

Instrument Panel Insulation
And Front Compartment
Rear Sight Shield
Turn Retainer
Buick Electra, LeSabre, Park Ave. &
Skylark, Cadillac DeVille,
Oldsmobile Achieva, Cutlass, Delta
88, 88 Royale & 98 Regency And
Pontiac Bonneville
& Grand Am
1991 - On
Upper Deflector Shield
Ford

UNIT PACKAGE: 25



21377
(11609483)
Black Nylon

Rear Hatch Sill Plate Retainer
Top Head Diameter: 12mm
Bottom Head Size: 17mm x 34mm
Stem Length: 15mm
Chevrolet HHR
2006 - On

UNIT PACKAGE: 10



21302
(11610748)
Black Nylon

Grille Retainer Nut
Hex: 13mm
Washer Diameter: 25mm
Overall Height: 7mm
Mates With Auveco No. 21301
Cadillac SRS & SRX and
Chevrolet Camaro
2010 - On

UNIT PACKAGE: 25



13856
(20461373)
Nylon

Rear Speaker Nut
M6 - 1.0 Thread
GM
1984-On

UNIT PACKAGE: 25

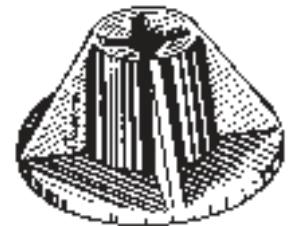

13456
(20478295)
Nylon

Carpet Retainer
GM
1985-On

UNIT PACKAGE: 10

Wire Loom Routing Clips

Black Nylon Routing Clips for Wire Loom (also called split flexible tubing, convoluted conduit or wiring harness)



19440
(12040984)
Black Nylon

Wire Loom Routing Clip
For 1/4" I.D.,
3/8" O.D. Loom

UNIT PACKAGE: 15



20397
(12160858)
Gray Nylon

Wire Loom Routing Clip
For 10mm I.D.,
13mm O.D. Loom

UNIT PACKAGE: 15



14547
(3816659,
8917320)
Black Nylon

Wire Loom Routing Clip
For 3/4" I.D.,
1" O.D. Loom

UNIT PACKAGE: 25



19795
(12015631)
Black Nylon

Wire Loom Routing Clip
For 1/4" I.D.,
3/8" O.D. Loom

UNIT PACKAGE: 15



14545
(8911497)
Black Nylon

Wire Loom Routing Clip
For 13/32" I.D.,
19/32" O.D. Loom

UNIT PACKAGE: 25



20665
(12160374)
Black Nylon

Wire Loom Routing Clip
For 19mm I.D.,
24mm O.D. Loom

UNIT PACKAGE: 15



14544
(8911473)
Black Nylon

Wire Loom Routing Clip
For 11/32" I.D.,
1/2" O.D. Loom

UNIT PACKAGE: 25



14546
(8911472)
Black Nylon

Wire Loom Routing Clip
For 1/2" I.D.,
11/16" O.D. Loom

UNIT PACKAGE: 25



20471
(8905794)
Black Nylon

Wire Loom Routing Clip
For 10mm I.D.,
13mm O.D. Loom

UNIT PACKAGE: 15



19851
(12040983)
Black Nylon

Wire Loom Routing Clip
For 1/2" I.D.,
11/16" O.D. Loom

UNIT PACKAGE: 15



16941
(12015983)
Black Nylon

Wire Loom Routing Clip
For 1" I.D.,
1-9/32" O.D. Loom

UNIT PACKAGE: 25

GENERAL MOTORS CLIPS & FASTENERS **Sec. 20**



20514
(12160857)
Gray Nylon

Wiring Harness Clip
Head Size: 9mm x 37mm
Fits Into 6.3mm (1/4") Hole
GM

UNIT PACKAGE: 50



14217
(GM: 1257702,
20346654;
Ford: 383207-S;
AMC: 3693099)
Nylon

Routing Clip
GM, Ford & AMC

UNIT PACKAGE: 25

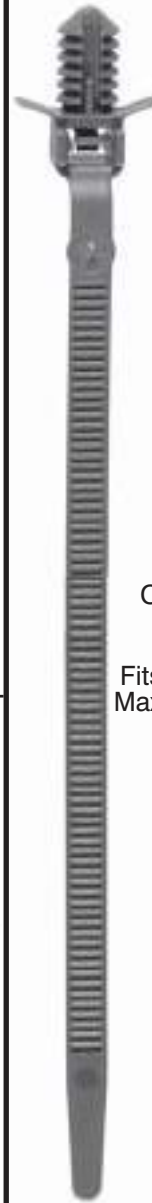

21203
(Not Available
From O.E.M.)
Gray Nylon

Cable Tie
Overall Length: 155mm
(6-1/8")
Width: 5mm (3/16")
Fits Into 6.3mm (1/4") Hole
Maximum Bundle Diameter:
30mm (1-3/16")
GM and Universal

UNIT PACKAGE: 25



19853
(12176844)
Gray Nylon

Wiring Harness Clip
Size: 3/8" x 2-1/2"
Stem Length: 1/2"
Fits Into 1/4" Hole
GM

UNIT PACKAGE: 25

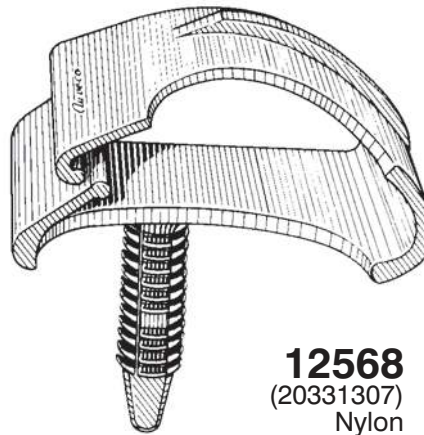

12568
(20331307)
Nylon

Wire Routing Clip
Stem: 5/16" x 11/32"
x 1-1/4" Long
GM 1981-On

UNIT PACKAGE: 10



13858
(20430956)
Nylon

Wire Clip
Models With Sunroof
GM
1984-On

UNIT PACKAGE: 25



12728
(14046480)
Nylon

Wire
Retaining Clip
GM 1981-On

UNIT PACKAGE: 25



12729
(25512081)
Nylon

Engine Compartment
Wire Clip
For 1/4" Diameter Tube
Buick w/ V-6 Diesel
1985-On

UNIT PACKAGE: 25



20312
(GM: 15021761;
Chry: 5027550AB)
Yellow Nylon

Hood Prop Rod Clip
7mm Rod Diameter
Snaps Into 10mm Hole
GM Cars & Trucks
1988 - On
Chrysler PT Cruiser
Isuzu Hombre
1990 - On

UNIT PACKAGE: 10



18395
Black Phosphate

Weatherstrip Clip
GM

UNIT PACKAGE: 50



21187
(Chrysler: 4806226-AA;
GM: 11562364)
Zinc

Front & Rear Bumper
and Grille Fastener
#6 Screw Size
Width: 10mm
Overall Height: 18mm
Buick Lucerne and
Cadillac CTS & STS
2005 - On
Chrysler 300, Dodge Nitro
and Jeep Commander
2005 - On

UNIT PACKAGE: 15



21284
(5482087)
White Nylon

Grille Clip
Overall Height: 14mm (9/16")
Chevrolet Equinox
2005 - On

UNIT PACKAGE: 25



11831
(554343,
562327; 1241972)

Bumper Fastener
GM
1973-On

UNIT PACKAGE: 50



11352
(3920179,
10013764)

Radiator Shroud Clip
Chevrolet 1968-On

UNIT PACKAGE: 100



**The World's Largest
Selection Of Body
Hardware &
Specialty Fasteners
For The Collision
Repair Professional**



18402

Phosphate & Green
Weatherstrip Clip
GM

UNIT PACKAGE: 25



18117
(10062366)

Retaining Clip
Map Pockets & Dash
GM
1990-On

UNIT PACKAGE: 25



18352

Black
Phosphate

Weatherstrip Clip
GM

UNIT PACKAGE: 25



14968
(10005510)

Bumper Impact Strip
Retainer
GM
1978-On

UNIT PACKAGE: 50



21387
(15683327)
Phosphate

Front Door
Interior Trim & Instrument Panel
Fastener
Width: 13/16"
Length: 15/16"
Chevrolet & GMC Trucks
2003 - On

UNIT PACKAGE: 10

GENERAL MOTORS CLIPS & FASTENERS **Sec. 20**



20860
(15078238)
Black

Radiator Grille &
Bumper Cover Fastener
Width: 5/8"
Length: 1"
Overall Height: 5/8"
GM Trucks & Vans
1999 - On

UNIT PACKAGE: 15



19519
(GM: 16662182;
Chrysler: 6502988)
Zinc Organic

Windshield Garnish Moulding,
Rear Side Door Garnish Moulding
& Liftgate Trim Finish Panel Fastener
Width: 1/2"
Height: 9/16"
Chevrolet Camaro, Corvette, &
Venture; Oldsmobile Silhouette and
Pontiac Firebird, Grand Prix &
Trans Sport
1993 - On

Chrysler 1996 - On
UNIT PACKAGE: 15



20268
(15748479)
Zinc & Yellow

Garnish Moulding Fastener
Width: 1/2"
Height: 5/8"
GM Cars & Trucks
1994 - On

UNIT PACKAGE: 25



20883
(11588650)
Zinc

Garnish, Interior Trim, Bezel
& Scuff Plate Fastener
Width: 15/32"
Height: 11/16"
GM Cars & Light Trucks
2002 - On

UNIT PACKAGE: 10



20619
(15046306)
Olive Drab

Rocker Panel Fastener
Head Size: 7/16" x 1-7/16"
Overall Height: 11/16"
GM S & T Trucks
2002 - On

UNIT PACKAGE: 15



18105
(15607139)

Nameplate Retainer
GM Trucks
C & K 1987-On

UNIT PACKAGE: 15

Not Actual Size

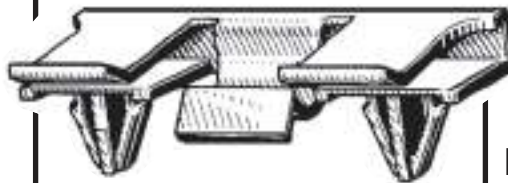

17356
(96061863)
Nylon

Radiator Grille Clip
Geo Tracker
2 Wheel & 4 Wheel Drive
1989-On

UNIT PACKAGE: 5



19616
(15025531;
15764320)
Black & Gray Nylon

Radiator Grille Retainer
Long Head Dia.: 30mm
Wide Head Dia.: 19mm
Snaps Into 13mm Hole
C & K Trucks
1999-On

UNIT PACKAGE: 10



18262
(15002520,
15682898)
Zinc Organic

Radiator Grille Retainer
GM Pickup, Van, Blazer, Jimmy
1994-On

UNIT PACKAGE: 25

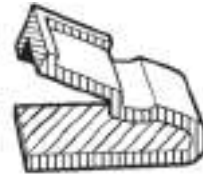

18748
(22527147)
Black Nylon

Radiator Grille Retaining Clip
Oldsmobile Calais &
Delta 88 Royale 1986
Pontiac Bonneville 1991-88

UNIT PACKAGE: 15

Looking For A Fastener

Not In The

Auveco Line?

E-mail Your New Item

Suggestion To:

mail@auveco.com



21027
(11518531)
Zinc Organic

Fender Bracket
Interior Trim, Door, Bumper & Hood
Retainer Nut
#8 (M4.2-1.41) Screw Size
Buick Enclave & Lucerne,
Chevrolet Equinox & Malibu,
Hummer and Pontiac G5,
G6, G8 & Solstice
2003 - On

UNIT PACKAGE: 15



19317
(15707256)
Zinc Organic

Front Fender Extension
& License Plate Bracket
Retainer Nut
M6-1.0 Screw Size
GM Express &
Savanna
1996-On

UNIT PACKAGE: 10



20396
Zinc & Yellow

1/4" - 20 Specialty Insert
Grip: .030" - .165"
Head Diameter: 1/2"
Hex Size: 3/8"
**Can be set with Auveco
Tool 11805**

UNIT PACKAGE: 15



18153
(11561448, 15686142)
Zinc Phosphate

Radiator Grille Nut
#8 Screw Size
GM Trucks
C & K, 1, 2 & 3
1993-On

UNIT PACKAGE: 25



17508
(15632790)
Zinc Organic

Grille Clip
GM S-10 & S-15 Pick-Ups
1991-On

UNIT PACKAGE: 5



20742
Zinc & Yellow

M4-.7 Specialty Insert
Grip: 2mm - 3.3mm
Head Diameter: 9.5mm
Hex Size: 6.2mm
**Can be set with Auveco
Tool 11805**

UNIT PACKAGE: 15



21524
(11610157)
Zinc Organic

Center Console
Door, Front Lights, Grille,
Instrument Panel &
Lift Gate Nut With Silicone Pad
M4.2-1.41 (#8) Screw Size
Cadillac CTS, Chevrolet Corvette,
Equinox, Malibu & Traverse,
Hummer H3, Pontiac G6
and Saturn Ion
2003 - On

UNIT PACKAGE: 10

**Body Hardware &
Specialty Fasteners
= Auveco**



20678
Zinc & Yellow

M5-.8 Specialty Insert
Grip: .5mm - 3.3mm
Head Diameter: 10mm
Hex Size: 7mm
**Can be set with Auveco
Tool 11805**

UNIT PACKAGE: 15



14820
(GM: 14083173,
17988488, 17997722,
Ford: N803685S)
Phosphate

Dash Panel Nut
Screw Size: #8 (M4.2-1.41)
GM & Ford 1982-On

UNIT PACKAGE: 25



17382
(14100784)
Phosphate

Bumper Valance Panel Retainer
Cadillac Eldorado & Seville
Chevrolet Lumina & Beretta
1987-On

UNIT PACKAGE: 25



19220
(10237960)
Zinc & Yellow

M6-1.0 Specialty Insert
Grip: .7mm - 4.2mm
Head Diameter: 12.5mm
Inside Door Handle,
Window Regulator &
Air Bag Module Attachment
Chevrolet Lumina, Monte
Carlo & Pontiac Grand Prix
1995-On
**Can be set With Auveco
Tool 11805**

UNIT PACKAGE: 25

GENERAL MOTORS CLIPS & FASTENERS **Sec. 20**



20415

(GM: 15685099;
Ford: N803763-S100)
Zinc & Yellow

M6-1.0 Specialty Insert w/ Sealer
Grip: .65mm - 2.0mm
Head Dia.: 12mm
Hex Size: 8mm
Roof Rack, Tailgate &
General Purpose
GM APV Vans, C & K Trucks
And Ford Explorer 1991 - On
**Can be set with Auveco
Tool 11805**

UNIT PACKAGE: 15



20423

(11519960)
Zinc & Yellow

M8-1.25 Specialty Insert
Grip: .7mm-4mm
Head Diameter: 17mm
Hex Size: 12.5mm (1/2")
Front Core Support &
General Purpose
GM Envoy & Trailblazer
2002 - On

**Can only be set with
Pneumatic Tool**

UNIT PACKAGE: 15



Not actual Size

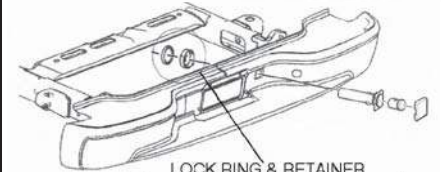

LOCK RING & RETAINER
The retainer and ring are damaged
whenever the bumper is removed.

21290

(15769308 - Retainer,
15040331 - Ring)
Zinc

Spare Tire
Lock Cylinder
Housing Retainer &
Lock Ring Kit
Retainer O.D.: 72mm
Lock Ring O.D.: 57mm
GM C/K, Denali, Sierra,
Silverado, Suburban,
Tahoe and Yukon
1999 - On

UNIT PACKAGE: 5 Kits



20395

(10281487)
Zinc & Yellow

M6-1.0 Specialty Insert
Grip: .7mm-4.2mm
Head Diameter: 13mm
Hex Size: 9.5mm (3/8")
Front Fender
Buick, Cadillac, Corvette,
L.D. Truck, Olds Aurora
And Pontiac
1997 - On

**Can be set with Auveco
Tool 11805**

UNIT PACKAGE: 15



9367

(4495047)

Front Seat
Arm Support
Hinge Pin Retainer
GM

UNIT PACKAGE: 100



15459

(1247872,
15567924)

Throttle Rod
Retaining Clip
For 1/4" Rod w/ 5/32" Groove
19/32" O.D.
GM
1975-On

UNIT PACKAGE: 50



9469

(3764554)
Nylon

Distributor To
Oil Pump Intermediate
Shaft Bushing
Chevrolet
1965-On

UNIT PACKAGE: 25



20422

(11519952)
Zinc

M6-1.0 Specialty Insert
Grip: .7mm-4mm
Head Diameter: 13mm
Hex Size: 9.5mm (3/8")
Front Core Support &
General Purpose
GM Envoy & Trailblazer
2002 - On

**Can only be set with
Pneumatic Tool**

UNIT PACKAGE: 15



21351

(11588441)
Zinc

Fender, Quarter Panel & Grille
Push-On Retainer
Stud Size: 6mm
O.D.: 24mm
GM & Hummer
2002 - On

UNIT PACKAGE: 50



14924

PVC Plastic

Door Lock Striker Bushing
9/16" I.D., 11/16" O.D.
3/4" Long
GM
1977-On

UNIT PACKAGE: 25



20562
(9601750)

Door Lock Striker Bolt Assembly
With PVC Plastic Bushing
1/2" - 13 Thread
Overall Length: 2-1/4"
GM Cars & Trucks
1991 - 73

UNIT PACKAGE: 1



17069
(16606936,
16633853)
White Nylon

Door Lock Rod Clip
Rod Size: 4mm
Head Dia: 10mm
GM
1982-On

UNIT PACKAGE: 100



19399
(16609280)
Green Nylon

Door Handle Rod Clip
Rod Size: 5/32"
Buick Skylark, Chevrolet
Caprice & Cavalier,
Oldsmobile Achieva/Cutlass
and Pontiac Grand Am &
Sunfire
1991-On

UNIT PACKAGE: 50



Right-Hand Side Left-Hand Side

10262
Nylon

Door Lock Rod & Hood
Latch Locking Push Rod Clip
Rod Size: 5/32"
Fits Into 1/4" Hole
Chrysler, Ford, GM & AMC

UNIT PACKAGE: 20 Pieces
10 Rights - 10 Lefts

20675

(AMC: 4003672R;
Chry: 2945108R, 4658676;
GM: 16627328
Ford: N805350S)
White Nylon

Clip For Right-Hand Side Only

UNIT PACKAGE: 25

14967

(AMC: 4003673L;
Chry: 2945109L, 4658677;
GM: 9815325, 16607593;
Ford: D2VZ-6521952A, N804344S)
Black Nylon

Clip For Left-Hand Side Only

UNIT PACKAGE: 50



18392
(20582532)
Black Nylon

Door Lock Rod Clip
Rod Size: 5/32"
Buick Regal & Roadmaster
Chevrolet Caprice, Olds Custom
Cruiser & Cutlass And
Pontiac Grand Prix
1992-On

UNIT PACKAGE: 25



18393
(20582533)
Natural Nylon

Door Lock Rod Clip
Rod Size: 5/32"
Buick Regal & Roadmaster Chevrolet
Caprice, Olds Custom Cruiser &
Cutlass And
Pontiac Grand Prix
1992-On

UNIT PACKAGE: 25



15673

(GM: 8891031;
Chrysler: 3454220,
4658676)
Red Nylon

Door Lock Rod Clip
Used On Right-Hand Side
Rod Size: 5/32"
GM C & K Pickups
2007 - 1999
Chrysler
1972 - On

UNIT PACKAGE: 50



15674

(GM: 8891030;
Chrysler: 3454221,
4658677)
Green Nylon

Door Lock Rod Clip
Used On Left-Hand Side
Rod Size: 5/32"
GM C & K Pickups
2007 - 1999
Chrysler
1972 - On

UNIT PACKAGE: 50



21196
(16630688)
White Nylon

Door Lock Rod Clip
Used On Right-Hand Side
Rod Size: 3/16" (5mm)
GM Pick-Up Trucks
1999 - On

UNIT PACKAGE: 25



21197
(16630689)
Black Nylon

Door Lock Rod Clip
Used On Left-Hand Side
Rod Size: 3/16" (5mm)
GM Pick-Up Trucks
1999 - On

UNIT PACKAGE: 25



18926

(14037239,
15545178)
Natural Nylon

Tailgate Rod Clip
Rod Size: 3/16"
GM Trucks C, K 1, 2, 3
1981-On

UNIT PACKAGE: 10



19658

(16629990,
16675980)
Gray Nylon

Door Lock Rod Clip
Rod Size: 5/32"
Buick, Cadillac, Chevrolet,
Oldsmobile, Pontiac &
Trucks
1996 - On

UNIT PACKAGE: 15



15518

(4234830, 12337868)

Door Lock Rod Clip
GM
1964-On

UNIT PACKAGE: 25



15759

(3998009,
9711304)

Door Lock Rod Clip
GM
1956-On

UNIT PACKAGE: 50

Not Actual Size



**PUT AN END TO CONTINUAL
TAILGATE CABLE REPLACEMENT!**

20872

2004 - 1999 full size GM Pick-Up Trucks are originally equipped with galvanized, braided steel tailgate cables that may corrode, weaken and eventually break. Auveco's 20872 stainless steel tailgate support straps are the ideal replacement. Our support strap is stronger and more durable than cable. It mounts the same as the original cable, uses the same hardware and can be installed in 15 minutes. The 20872 can be used for both sides of the tailgate.

UNIT PACKAGE: 1



19340

(3538281)
Rubber

Air Inlet Screen
Rubber Retainer
Head Diameter: 1"
Stem Length: 5/16"
Fits Into 1/4" Hole
Cadillac DeVille
1992-On

UNIT PACKAGE: 10



4406

Rubber

Brake Adjusting Screw
Hole Rubber Plug
Fits 5/16" x 1" Hole

UNIT PACKAGE: 25

**GM Truck
Door Hinge Pin & Bushing Repair Kits**

Why bother with the hassle of cutting and grinding off a worn door hinge and welding on a new one when you can repair the bad hinge in a fraction of the time?

With our Door Hinge Pin & Bushing Repair Kits, fixing sagging doors caused by worn hinges due to pin failure is quick. It's easy. It works. And you don't have to repaint the welded heat flash area.

Each kit is designed to repair one hinge and contains all the pins, bushings and related hardware to do the job.

Here's how it works:

1. Remove the door from the truck body
2. Remove the original equipment pin and bushings
3. Install the bushings into the hinge holes
4. Install the longer pin into the top hinge hole
5. Thread on the lock nut
6. Install the shorter pin into the bottom hinge hole
7. Place the washer and a nut on the shorter pin
8. Tighten the nut to pull the pin into place.
9. Slowly tighten both upper and lower lock nuts
10. Reattach the door to the truck body

Detailed instructions are included with the kit.



Not Actual Size

20485
(89025539)

Door Hinge Pin and Bushing Kit
Cadillac Escalade
2006 - 2000
Chevrolet Silverado
& GMC Sierra:
1500/2500, HD / 3500, HD
2007 - 1999
Chevrolet Suburban 1500/2500
& Tahoe
2006 - 2000
GMC Yukon 2006 - 2001

UNIT PACKAGE: 1 Kit



Not Actual Size

21092
(89025543)

Extended Cab Rear
Door Hinge Pin and
Bushing Kit
Chevrolet Silverado &
GMC Sierra:
1500/2500/3500
2005 - 1999,
1500HD/2500HD/3500HD
2005 - 01
1500/2500HD
Classic Hybrid LT 2007 - 06,
1500 Classic Hybrid 2007 - 05

UNIT PACKAGE: 1 Kit



Not Actual Size

21072
(89025546)

Side Cargo Door
Greaseable Stainless Steel
Hinge Pin & Bushing Kit
GM Savana Van &
Express Van
2008 - 1996

UNIT PACKAGE: 1 Kit



Not Actual Size

21610
 (12338074, 15562609,
 15562610, 15653790,
 15691493, 15964971,
 15964972, 16632192
 & 16632193)

Door Hinge Pin & Bushing Kit
 Repairs One Hinge
 Contains one Auveco 19781 pin,
 one each of Auveco bushings
 16936 & 16937 and one of
 17976 pin retainer
 GM S & T Trucks
 1994 - On

UNIT PACKAGE: 1 Kit



Not Actual Size

21644
 (12338074, 15562609,
 15562610, 15591860,
 15691493, 15691595,
 15964971, 15964972,
 15967691, 16632192,
 16632193, 88891731)

Door Hinge Pin & Bushing Kit
 Repairs One Hinge
 Contains one Auveco pin 19424,
 one each of Auveco bushings
 16936 & 16937 and one of
 Auveco 17976 pin retainer
 GM C & K Trucks
 1988 - On

UNIT PACKAGE: 1 Kit



21403
 (19260060)

Greaseable Stainless Steel
 Door Hinge Pin, Bushing
 & Bracket Repair Kit
 Repairs One Hinge
 (Upper or Lower) Driver's Side

Cadillac Escalade 2006 - 2002
 Chevrolet Avalanche 2006 - 2002
 Chevrolet Silverado 2006 - 1999
 Chevrolet Silverado Classic 2007
 Chevrolet Suburban 2006 - 2000
 Chevrolet Tahoe 2005 - 2000
 GMC Sierra 2006 - 1999
 GMC Sierra Classic SLE 2007
 GMC Yukon 2002
 GMC Yukon Denali 2004 - 2001
 GMC Yukon S 2006 - 2005
 GMC Yukon SLE 2000

UNIT PACKAGE: 1

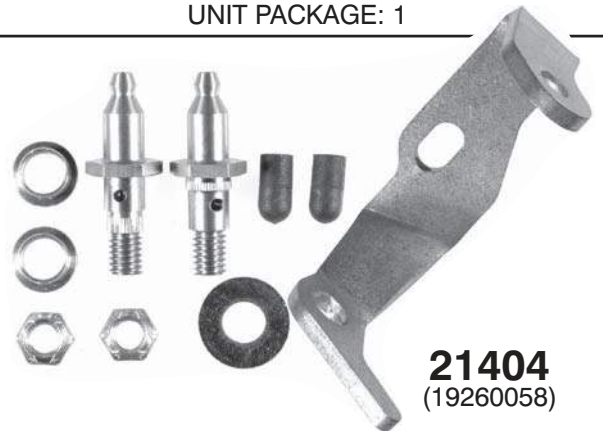

21404
 (19260058)

Greaseable Stainless Steel
 Door Hinge Pin, Bushing
 & Bracket Repair Kit
 Repairs One Hinge
 (Upper or Lower) Passenger's Side

Cadillac Escalade 2006 - 2002
 Chevrolet Avalanche 2006 - 2002
 Chevrolet Silverado 2006 - 1999
 Chevrolet Silverado Classic 2007
 Chevrolet Suburban 2006 - 2000
 Chevrolet Tahoe 2005 - 2000
 GMC Sierra 2006 - 1999
 GMC Sierra Classic SLE 2007
 GMC Yukon 2002
 GMC Yukon Denali 2004 - 2001
 GMC Yukon S 2006 - 2005
 GMC Yukon SLE 2000

UNIT PACKAGE: 1



Not Actual Size

21405

Stainless Steel

Door Hinge Pin & Bushing
Repair Kit
Repairs Two Hinges

Cadillac Escalade & Escalade ESV;
Chevrolet Avalanche 4-door
pickup/SUV, Silverado, Suburban
4-door extended SUV,
& Tahoe 4-door SUV; GMC Sierra,
Yukon & Yukon XL
2013 - 2007

UNIT PACKAGE: 1



Not Actual Size

21582

(GM: 19260663)

Greaseable Stainless Steel

Door Hinge Pin & Bushing
Repair Kit

Repairs Two Side Cargo Door Hinges
Chevrolet Express &
GMC Savana Van
2013 - 2009

UNIT PACKAGE: 1



Not Actual Size

21409

Stainless Steel

Door Hinge Pin & Bushing
Repair Kit
Repairs Two Hinges, Front Door
Chevrolet Cavalier &
Pontiac Sunfire
2005 - 1995

UNIT PACKAGE: 1



Not Actual Size

21406

(19260061)

Greaseable Stainless Steel

Door Hinge Pin & Bushing
Repair Kit
Repairs Two Hinges

Cadillac Escalade & Escalade ESV;
Chevrolet Avalanche 4-door
pickup/SUV, Silverado, Suburban
4-door extended SUV,
& Tahoe 4-door SUV; GMC Sierra,
Yukon & Yukon XL
2013 - 2007

UNIT PACKAGE: 1



21444

(19260063)

Greaseable Stainless Steel

Door Hinge Roller Pin Kit
Repairs One Hinge
Driver's Side or Passenger's Side
Lower Hinge
Chevrolet Silverado 2013 - 2007
GMC Sierra 2013 - 2007
And Related Suv's (T-900)

UNIT PACKAGE: 1

GENERAL MOTORS CLIPS & FASTENERS **Sec. 20**



Not Actual Size

21486
 (Not Available From O.E.M.)
Stainless Steel
 Door Hinge Pin & Bushing
 Repair Kit
 Repairs One Hinge (Upper
 or Lower) Front Doors
 Buick Rainier, Chevrolet Trailblazer
 and GMC Envoy
 2011 - 02
 UNIT PACKAGE: 1



Not Actual Size

21487
 (19260056)
Greaseable Stainless Steel
 Door Hinge Pin & Bushing
 Repair Kit
 Repairs One Hinge (Upper
 or Lower) Front Doors
 Buick Rainier, Chevrolet Trailblazer
 and GMC Envoy
 2011 - 02
 UNIT PACKAGE: 1



Not Actual Size

19725
 (Not Available
 From O.E.M.)
 Zinc
 Door Hinge Roller Pin
 Assembly
 Diameter: 9/16"
 Length: 5-1/2"
 Roller O.D.: 3/4"
 Roller Groove Dia: 5/8"
 Knurl Dia: 19/32"
 GM C & K
 Light Duty Trucks
 2000 - 88
 UNIT PACKAGE: 1



Not Actual Size

19782
 (15672183)
 Zinc
 Door Hinge Roller
 Pin Assembly
 Pin Diameter: 25/64"
 Overall Length: 5-1/16"
 Roller O.D.: 3/4"
 Roller Groove
 Diameter: 5/8"
**Use With Auveco 8829
 E-Type Retaining Ring**
 Rear Door Upper Hinge
 S & T Trucks
 1994 - On
 UNIT PACKAGE: 1



Not Actual Size

19781
 (15653790)
 Zinc & Yellow
 Door Hinge Pin
 Length: 4-1/8"
 Pin Diameter: 11/32"
 Shoulder O.D.: 3/8"
 Head O.D.: 1/2"
**Use With Auveco Bushings
 16936 & 16937 &
 Pin Retainer 17976**
 S & T Trucks
 1994 - On
 UNIT PACKAGE: 2

Not Actual Size



14559

(GM: 6271989,
20046147)
Phosphate

Door Hinge Pin
Length: 4-1/16"
Pin Dia: 11/32"
Head O.D.: 9/16"

- Buick: Estate Wagon & LeSabre Wagon 90-82, Electra 82, Regal 87-82, Riviera 85-82, All exc. Skyhawk 77-76;
- Cadillac: Cimarron 88-82, Eldorado & Seville 85-82, Fleetwood Brougham 92-82;
- Chevrolet: Camaro 81-78, C & K Trucks 84 - 73 Monte Carlo, Malibu & El Camino 88-76 Impala & Caprice 90-82, Nova 79-77;
- Oldsmobile: Cutlass Supreme, Calais & Cruiser 88-76, Delta 88 90-77, Omega 79-77, Toronado 85-82, 98 Recency 82-77;
- Pontiac: Firebird 81-78, Grand Prix 87-77, LeMans & Grand Am 81-77 Phoenix & Ventura 79-77, Safari & Parisienne 89-83

UNIT PACKAGE: 10

Not Actual Size



19183

(GM: 20043351)
Phosphate

Door Hinge Pin
Length: 4"
Pin Dia: 11/32"
Head O.D.: 7/16"

- Buick: Skyhawk 88-82, Skylark 85-82;
- Chevrolet: Cavalier 94-82, Celebrity 90-82, Chevette 87-78, Citation 85-80
- Oldsmobile: Cutlass Ciera 95-82, Firenza 88-82, Omega 84-80,
- Pontiac: Phoenix 84-80, Sunbird 94-82, T-1000 87-82, 6000 91-82

UNIT PACKAGE: 10

Not Actual Size



19424

(15591860; 15691595;
15967691; 88891731)
Stainless Steel

Door Hinge Pin
Length: 5-1/4"
Pin Dia: 11/32"
Shoulder O.D.: 3/8"
Head O.D.: 9/16"
GM Trucks
C-K Models 1988-On
Use With Auveco Bushings 16936 & 16937 & Pin Retainer 17976

UNIT PACKAGE: 4

Not Actual Size



17343

(15646148)
Stainless Steel

Door Hinge Pin
Length: 4-1/8"
Pin Dia: 11/32"
Shoulder O.D.: 3/8"
Head O.D.: 9/16"
GM Trucks
C-K 1,2,3
4 Door Pick-Up
Rear Door
1992-On

UNIT PACKAGE: 5



17976

(15562610)
400 Series
Stainless Steel

Door Hinge Pin Retainer
21/64" I.D., 9/16" O.D.
1/64" Thick
GM Trucks C-K
1988-On
Used With 19424 & 19781 Door Hinge Pin

UNIT PACKAGE: 50



Not Actual Size

17437
 (12338015,
 14066728)
 Zinc & Yellow
 Door Hinge Pin
 Length: 4-5/32"
 Pin Dia: 11/32"
 Head O.D.: 15/32"
 GM Astro Van,
 Safari Van & S-10
 1982-On
 UNIT PACKAGE: 5



Not Actual Size

17436
 (10102434)
 Phos. & Oil
 Trunk Lid Hinge Pin
 Length: 2-21/32"
 Pin Dia: 11/32"
 Head O.D.: 15/32"
 Buick Regal, Cadillac,
 Eldorado & Seville,
 Chevrolet Lumina,
 Oldsmobile Cutlass
 & Pontiac Grand Prix
 1988-On
 UNIT PACKAGE: 10

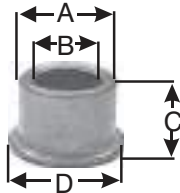

Door Hinge Bushings

Auveco Part No.	Dimensions			
	O.D. "A"	I.D. "B"	Height "C"	Flange O.D. "D"
14548	1/2"	3/8"	15/32"	5/8"
14549	1/2"	11/32"	3/8"	19/32"
14550	27/64"	11/32"	19/64"	19/32"
14553*	31/64"	11/32"	23/64"	19/32"
16936*	1/2"	11/32"	23/64"	43/64"
16937*	17/32"	25/64"	23/64"	11/16"

*Splined O.D.



14548
 (9822198)
 Buick 1975-42
 Chevrolet:
 Monza & Vega
 1980-76
 All (Exc. Corvette)
 1975-62
 Olds Starfire 1980-76
 Pontiac:
 Astre &
 Sunbird 1980-76
 All 1975-49
 UNIT PACKAGE: 25



14549
 (9716926, 20345137)
 Thick Bushing
 Buick 1976-On
 Cadillac 1980-On
 Chevrolet:
 All 1976-On
 Corvette 1982-73
 Olds
 Exc. Starfire 1980-On
 Pontiac Exc. Astre &
 Sunbird 1980-On
 UNIT PACKAGE: 25



14550
 (GM: 9721917;
 Ford: D1AZ-6522841A)
 Buick (Exc. Skyhawk)
 1967-On
 Cadillac 1946-On
 Chevrolet:
 Exc. Monza & Vega
 1962-On
 Corvette 1956-On
 GM
 C & K Trucks 1993 - 79
 Olds Exc.
 Starfire 1949-On
 Pontiac Exc. Astre &
 Sunbird 1932-On
 UNIT PACKAGE: 25



14553
 (20429500)
 Splined O.D.
 All GM (Including
 Pick-Ups & Vans) 1968-On
 UNIT PACKAGE: 25
 (Continued On Next Page)



16936

(12338074, 15691493, 15964971, 16632193)

Splined O.D.
Side Door Upper Hinge
GM Trucks
C-K Models 1988-On

UNIT PACKAGE: 25



16937

(15562609, 15964972 & 16632192)

Splined O.D.
Side Door Lower Hinge
GM Trucks
C-K Models 1988-On

UNIT PACKAGE: 25



12314

(20037597)

Clear Knob
GM 1952-On

UNIT PACKAGE: 1



12315

(1732326)

Black Knob
GM 1952-On

UNIT PACKAGE: 1



12316

(458030)

GM Trucks 1977-On

UNIT PACKAGE: 1

HELPFUL HINTS.....

FOR USING THE AUVECO CATALOG

1. **The color-coded pages** signify various sections which are as follows:
 BLUE - Metric Items
 BEIGE - Electrical Accessories
 GREEN - Assortments, Cabinets, Bins & Racks
 GRAY - Key Blanks & Accessories
 PINK - Import Car Body Hardware
2. Most pictures and illustrations are actual size.
3. We have **Specification Charts** for:
Body Bolts (pages 20 & 49-50)
Special Tapping Screws (pages 23-26 & 54-57)
License Plate Screws (pages 33-34)
"Xmas Tree" Retainers (pages 404-413)
Push-Type Retainers (pages 450-460)
4. We have **three different types of indexes** in the front of the catalog to assist you.
 PICTORIAL QUICK INDEX
 ALPHABETICAL INDEX
 NUMERICAL INDEX
5. There are two **O.E.M Part Cross References** at the back of the catalog.

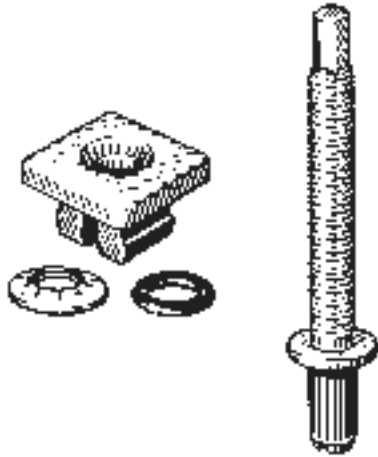

15968
(E6DZ-13032A)

Adjusting Screw Assembly
Hex & Slotted Drives
Taurus & Sable
1988-86

UNIT PACKAGE: 10

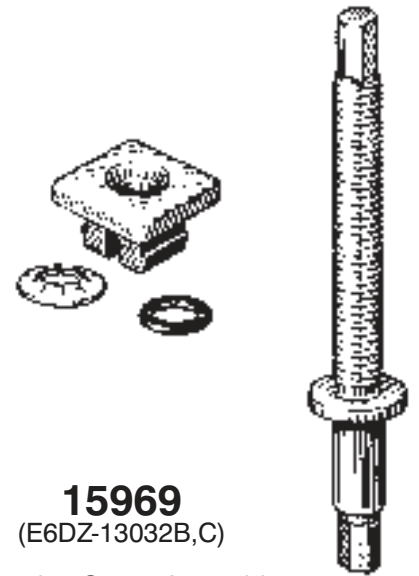

15969
(E6DZ-13032B,C)

Adjusting Screw Assembly
Hex Drives
Taurus & Sable
1986-On

UNIT PACKAGE: 10

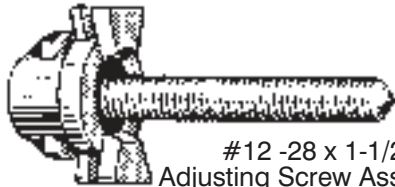

15966
(E7SZ-13032-D)

#12 -28 x 1-1/2"
Adjusting Screw Assembly
R.H. Upper, L.H. Lower
Phillips Drive
T-Bird, Cougar &
Continental 1988-87

UNIT PACKAGE: 5

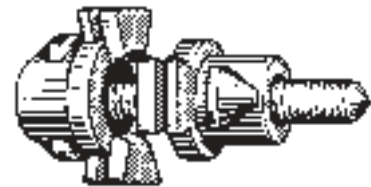

16399
(E9TZ-13032B, E97B-13A093BA)
Black Screw

Bronco & Ranger
1989-On

UNIT PACKAGE: 5

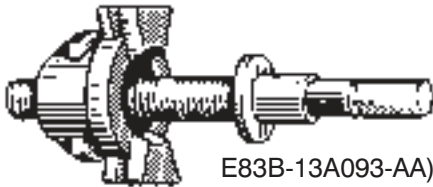

16733
(F03Z-13032A,
E83B-13A093-AA)

Vertical Adjuster
Tempo & Topaz 1990-On

UNIT PACKAGE: 5

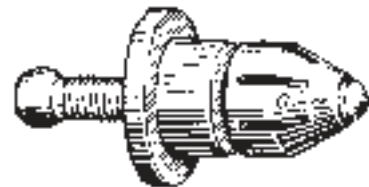

16406
(E9WY-13032C, E9WB-13A093CA)

Pivot Point Adjuster
Cougar
1989-On

UNIT PACKAGE: 10



16396
(E8FZ-13032A, E8EB-13A093AA,
E8EB-13A093AB)

Vertical Adjuster, Escort & Lynx 1990-88

UNIT PACKAGE: 5

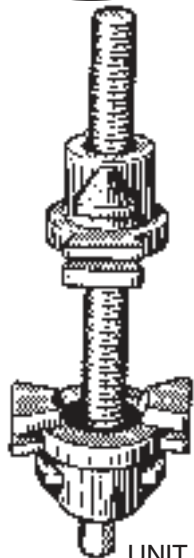

16397
(E8FZ-13032B,
E8EB-13A093BA)
Horizontal Adjuster,
Escort & Lynx
1990-88

UNIT PACKAGE: 5

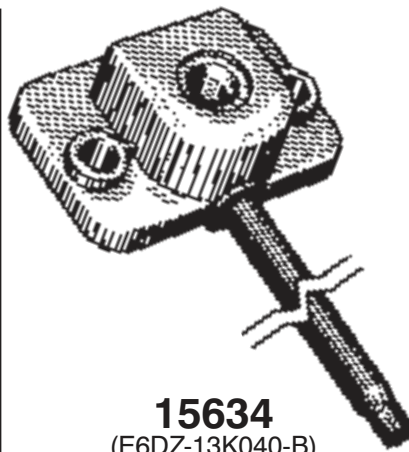

15634
(E6DZ-13K040-B)
Headlight Adjuster
Escort & Lynx 1985-On
Sable & Taurus 1986-On

UNIT PACKAGE: 1



12228
(FDA13021-A)
Zinc-Nylon Nut

1/4"-28 Thread
Headlight Adjusting Nut Mount
Ford
1980-On

UNIT PACKAGE: 10



11660
(DOZB-13A-093-AA)
Zinc Screw &
Phosphate Plate

1/4"-28 x 2"
Headlight Adjusting Screw
& Nut Assembly
Ford Cars & Medium Duty Trucks
1973-On

UNIT PACKAGE: 10

11661

Same as 11660
Except Packing

UNIT PACKAGE: 25



11869
(D8BZ-13032A, B,
D8BB-13M-093AA)
Zinc

#12-28 x 1-3/4"
Headlight Adjusting
Screw & Nut Assembly
Ford 1978-On

UNIT PACKAGE: 10

11870

Same as 11869 Except Packing
UNIT PACKAGE: 100



21185
(W710793-S439)
Zinc Organic

Headlight Mounting Clip
M6-1.0 Thread
Ford Super Duty Pick-Up
2009 - 08

UNIT PACKAGE: 10



18899
(F1CZ-13A147A)
Black Nylon

Headlight Pivot Socket
Escort & Tracer
1991-On

UNIT PACKAGE: 25



12609
(D9ZB-13A093 AA)

#12-28 x 1-3/4"
Headlight
Adjusting Screw
& Nut Assembly
Ford
1979-On

UNIT PACKAGE: 10



15940
(E9DB-13N020AA, E9DZ-13N129A)

Headlight Component
Pivot Retaining Clip
Ford Taurus & T-Bird and
Mercury Cougar & Sable
1989-On

UNIT PACKAGE: 25



18263

(F37Z-13N129-A)
Black

Headlight Component
Retaining Clip
Mustang & Ranger
1993-On

UNIT PACKAGE: 25



15814

(E5LB-13A147AA,
E5LY-13A147A)

Headlight Adjuster Retainer
Escort & Lynx,
Lincoln Mark VI, VII,
and Mercury
Tempo & Topaz
1985-On

UNIT PACKAGE: 25



16425

(E9SZ-13N019B,
E9SB-13N019-BA)
Nylon

High Beam 9005 Bulb Retainer
Ford T-Bird & Cougar
1989-On

UNIT PACKAGE: 10



18155

(N803768-S)
Natural Nylon

Door Arm Rest Nut
#8 Screw Size
Mustang & Capri
1987-On

UNIT PACKAGE: 15



18384

(W700800-S300)
Black Nylon

Nylon Grommet
Back Lower Finish
Panel Assembly
Contour & Mystique
1995-On

UNIT PACKAGE: 50



19280

Black Nylon

Door Window Glass
To Regulator Nut
Contour & Mystique
1995-On

UNIT PACKAGE: 5



19281

(F5RZ-5421416B)

Door Window Glass
To Regulator Fastener
Assembly
3/8"-16 x 3/4" Grade 8
Cap Screw
Contour & Mystique
1995-On

UNIT PACKAGE: 2 Sets



10305

White Nylon

Nylon Nut
#8 Screw Size

UNIT PACKAGE: 50



9862

(379830-S)
White Nylon

Headlight Door, Grille
& Mirror Nut
#8 or #10 Screw Size
Fits Into 1/4" Sq. Hole
Ford

UNIT PACKAGE: 50



14755

(379830-S)
White Nylon

#8 Screw Size
3/8" Wide, 3/8" Long
Fits Into 1/4" Sq. Hole
Ford
1986-On

UNIT PACKAGE: 25



14756

(Ford: 379830-S;
Chry: 6033677)
Black Nylon

#8 Screw Size
3/8" Wide, 3/8" Long
Fits Into 9/32" x 9/32" Hole
Panel Thickness: 1/4"
Ford & Chrysler
1986-On

UNIT PACKAGE: 25



20245

(N806334-S,
W707157-S300)
Natural Nylon

Nylon Nut
M4.2 (#8) Screw Size
Head Size: 10mm x 10mm
Fits Into 6mm Square Hole
Ford
1999 - On

UNIT PACKAGE: 50



18383

(W700566-S300)
Natural Nylon

#12 Screw Size
Back Panel Attachment
Contour & Mystique
1995-On

UNIT PACKAGE: 25



11865

(GM: 1255823;
Ford: 389360S)
Natural Nylon

Tail Light Nut
#6 or #8 Screw Size
Ford 1981-On
Front End Bezel Nut
GM 1979-On

UNIT PACKAGE: 50



12569

(Ford: N801706-S;
Chry: 6501773)
Black Nylon

#10 Screw Size
Ford
1981-On

UNIT PACKAGE: 25



14754

(N802376-S)
Blue Nylon

#8 Screw Size
1/4" Long, 3/8" Wide
Fits Into 7/32" x 7/32" Hole
Panel Thickness: 5/32"
Ford

UNIT PACKAGE: 25



20927

(N811478-S100)
Black Nylon

License Plate & Rear Bumper
Nylon Nut With Sealer
M6.3 (#14) Screw Size
Head Size: 16mm x 16mm
Stem Length: 8mm
Fusion & Mustang
2005 - ON

UNIT PACKAGE: 15



21368

(W711079-S300)
Black Nylon

Tail Light Grommet
Head Size: 13mm x 17mm
Stem Length: 10mm
Explorer, Mountaineer
& Pick-Up Trucks
2006 - On

UNIT PACKAGE: 25



11308

White Nylon

Nylon Nut
#8 or #10 Screw Size

UNIT PACKAGE: 50



19277

(N804765-S)
Natural Nylon

Wheel Opening
Screw Grommet
#8 (M4.2) Screw Size
Head Size: 3/8" x 3/8"
Stem Length: 7/8"
Mustang, T-Bird, Cougar &
Continental
1993-On

UNIT PACKAGE: 50



20939

(W711412-S300)
Natural Nylon

Rear Bumper
Screw Grommet
M4.2 (#8) Screw Size
Head Size:
9.5mm x 9.5mm
Stem Length: 12mm
Fusion
2006 - On

UNIT PACKAGE: 50



21362

(W708580-S300)
Black Nylon

Side Marker
Tail Light & Bumper
Screw Grommet
Screw Size: M4.2 (#8)
Head Size: 11.5mm x 11.5mm
Stem Length: 18mm
Expedition, Fusion, Milan,
MKZ & Navigator
2006 - On

UNIT PACKAGE: 25



20393

(W706575-S300)
Natural Nylon

Door Panel Screw Grommet
M4.2 (#8) Screw Size
Stem Length: 20mm
Fits Into 10mm Square Hole
Ford Escape
2001 - On

UNIT PACKAGE: 50



20425

(F5RZ-17K657-A)
Natural Nylon

Windshield Washer
Reservoir Mounting
Screw Grommet
Use with #12 Screw
Head Dia: 1/2"
Overall Length: 13/16"
Fits Into 3/8" Sq. Hole
Ford Contour, Focus & Mystique
1995 - On

UNIT PACKAGE: 25



19326

(N807706-S)
Natural Nylon

Front Bumper
Fascia Grommet
Escort, Explorer
& Mustang
1996-On

UNIT PACKAGE: 25



21239
(W708319-S300)
White Nylon

Front Bumper
Screw Grommet
With Sealer
M4.8 (#10) Screw Size
Head Diameter: 16mm
Stem Length: 24mm
Fusion
2009 - On

UNIT PACKAGE: 25



20532
(W708045-S300)
Black Rubber

Rear Bumper Cover
Grommet
Head Diameter: 15mm
Stem Length: 21mm
Fits Into 9.5mm Hole
Use With Auveco 20531
Ford Expedition
2003 - On

UNIT PACKAGE: 25



11841
(N-800503S)
Black Nylon

Grille Attachment Nut
#6 Screw Size
Ford 1978-On

UNIT PACKAGE: 50

**For up-to-date information
on new items
available from Auveco,
refer to the
"Hot New Items"
section of the
Auveco web site
(www.auveco.com)**



21165
(W712160-S300)
Black Nylon

Headlight Grommet
Screw Size: M6 (#14, 1/4")
Head Size: 22mm x 23.5mm
Overall Height: 18mm
Expedition, F150 and
Navigator
2003 - On

UNIT PACKAGE: 15



20466
(GM: 25649667;
Ford:
W705590-S300,
W710549-S300)
Natural Nylon

Screw Grommet
With Sealer
M4.2 (#8) Screw Size
Head Size: 13mm x 22mm
Stem Length: 18mm
Back Glass Moulding
& Interior Trim
Cadillac & Ford Windstar
1998 - On

UNIT PACKAGE: 15



21300
(Ford: 3M8Z-17C432-A;
Mazda: GK2A-50-798)
White Nylon

Cowl Vent
Screw Grommet
With Sealer
M4.8 (#10) Screw Size
Head Size: 15mm x 27mm
Stem Length: 13mm
Fusion, Milan, MKZ
& Zephyr and Mazda 6
2003 - On

UNIT PACKAGE: 5



21224
(Ford: F50Y-14603-A)
Black Nylon

Headlight and
Tail Light Grommet
Head Size: 18.5mm x 21.5mm
Stem Length: 18mm
Fits Into 9.5mm x 21.5mm Hole
Explorer, Navigator and
Super Duty Pick-Up
2003 - On

UNIT PACKAGE: 25



20517
(W707606-S300)
Black Nylon

Rear Bumper Cover
Screw Grommet
M4.8 (#10) Screw Size
Head Size: 18mm x 24mm
Stem Length: 18mm
Ford Escape
2001 - On

UNIT PACKAGE: 15



20336
(F7CZ-17C756-BA)
Black Nylon

Front & Rear
Bumper Cover Grommet
Use With #12 Screw
Stem Length: 1/2"
Escort & Tracer
1997 - On

UNIT PACKAGE: 15



20264
(N806363-S)
White Nylon

Kick Panel Grommet
Head Dia: 23mm
Overall Length: 24mm
**Used With Auveco
Retainer 19760**
Ford Ranger
1993-On

UNIT PACKAGE: 25



21304

(Ford: 3M8Z-16K262-A;
Mazda: GJ6A-50-ES1)
Black Nylon

Rear Bumper Grommet
With Sealer
Head Size: 27mm x 30mm
Stem Length: 32mm
Fits Into 17mm x 20mm Hole
Ford Fusion, Milan, MKS, MKZ
& Zephyr and Mazda 6
2003 - On

UNIT PACKAGE: 5



17317

(F1CZ-8A188-A)
Black Nylon

Radiator Grille Spacer
Ford Escort & Mercury Tracer
1991-On

UNIT PACKAGE: 25



20530

(Not Available
From O.E.M.)
Black Nylon

Radiator Shroud
Air Deflector Retainer
Head Diameter: 20mm
Stem Diameter: 13mm
Stem Length: 16mm
Ford Expedition
2003 - On

UNIT PACKAGE: 50



17195

(Isuzu: 8942180270)
Black Nylon

Grille Clip
13mm Wide, 22mm Long
Ford Escort, Honda,
Isuzu, Mitsubishi & Plymouth Laser

UNIT PACKAGE: 25



20171

(N807189-S100,
N811353-S100)
White Nylon

Cowl Vent Grommet
M4.2 (#8) Screw Size
Fits Into 10mm x 14mm Hole
F150 Pickup, Expedition
& Windstar
1995 - On

UNIT PACKAGE: 10



19138

(Ford: F1CZ-5802316A;
Mazda: BW0A-50-792)
Black Nylon

Cowl Top Vent Grille Retainer
Ford Escort & Tracer
Mazda
1991-On

UNIT PACKAGE: 15



19238

(F6DZ-5402316-AA)
Natural Nylon

Cowl Top Vent Grille
Grommet
Use With Auveco 19237
Ford Taurus & Sable
1996-On

UNIT PACKAGE: 50



19237

(W701649-S,
W704881-S300)
Black Nylon

Cowl Top Vent Grille
Nylon Screw
#10 x 1-1/32"
9/16" Head O.D.

Use With Auveco 19238
Ford Taurus & Sable
1996-On

UNIT PACKAGE: 50

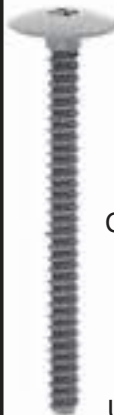

19517

(N811849-S300)
Black Nylon

Cowl Top Vent Grille
Nylon Screw
#10 x 2-1/16"
9/16" Head O.D.

Ford Trucks
1998 - On

UNIT PACKAGE: 25



17551

(Mazda: GJ21-50-H81)
Natural Nylon

Cowl Screen Grommet
Ford Probe and
Mazda 626 & MX6
1988-On

UNIT PACKAGE: 25



17552

(Mazda: GJ21-50-H82)
Natural Nylon

Cowl Screen Grommet
Ford Probe and
Mazda 626 & MX6
1988-On

UNIT PACKAGE: 25



17553
(Mazda:
KA01-50-H16)
Yellow Nylon

Rear Hatch Grommet
Use With 17554
Ford Probe and
Mazda MX 6
1988-On

UNIT PACKAGE: 25



17554
(Mazda:
KA01-50-H15A)
Black Nylon

Rear Hatch Retainer
Use With 17553
Ford Probe and
Mazda MX6
1988-On

UNIT PACKAGE: 25



18816
(N807994-S)
Black Nylon

Grille & Side Marker
Light Grommet
Fits Into 10mm Hole
Ford
1994-On

UNIT PACKAGE: 50



17667
Green Nylon

Tubular Nut
3/8" Hole Size
Lower Body Side Moulding
Lincoln Town Car
1990-On

UNIT PACKAGE: 25



19526
(N807247-S)
Natural Nylon

Rear Door & Back Window
Trim Panel Grommet
#12 - 24 Screw
Fits Into 1/2" Hole
Lincoln Town Car
1990 - On

UNIT PACKAGE: 25



19783
(N811169S,
W705550-S300)
White Nylon

Park & Turn Signal
Housing Grommet
7/32" Stud Size
Head Diameter: 13mm
Stem Length: 9mm
Fits Into 11mm Hole
F250 - F550 Trucks
1999 - On

UNIT PACKAGE: 50



19752
(Not Available
From O.E.M.)
White Nylon

Door Belt Moulding Clip
Taurus, Sable
Contour & Mystique
1998 - 95

UNIT PACKAGE: 15



20400
(YF4Z-8194-AA)
Nylon

Radiator Grille Clip
Width: 11/32"
Length: 1-9/32"
Mercury Sable
2000 - On

UNIT PACKAGE: 15



19154
(E2EB-61290C62-AA)
Nylon

Body Side Moulding Clip
Escort & Lynx
1981-On

UNIT PACKAGE: 25



17451
(Mazda: H001-68-719B)
Nylon

Rocker Scuff Plate Retainer
Ford Probe and
Mazda MX6
1988-On

UNIT PACKAGE: 25



12559
(D5UB-2221066AA)
Nylon

Moulding Clip
Ford
1980-On

UNIT PACKAGE: 50

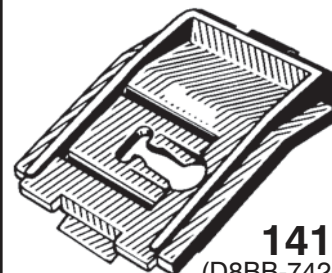

14137
(D8BB-7420828-AA)
Nylon

Moulding Clip
Ford
1978-On

UNIT PACKAGE: 25



21306
(Not Available From O.E.M.)
White Nylon

Belt Moulding Clip
Width: 18mm
Length: 37mm
Taurus
2010 - On

UNIT PACKAGE: 10



21507

(Not Available From O.E.M.)
White Nylon

Belt Moulding Clip
Width: 25mm
Length: 36mm
Overall Height: 27mm
Edge
2009 - On

UNIT PACKAGE: 15



14213

(D42B-6021066BA)
Nylon

Body Side Moulding
Mustang

UNIT PACKAGE: 25



18377

(W701430-S300)
Black Nylon

Door Trim Retaining Clip
Contour & Mystique
1995-On

UNIT PACKAGE: 10

Please E-mail
Your New Item
Suggestions To
mail@auveco.com



20862

(4L3Z-1510182-AA)
Black Nylon

Roof Garnish
Moulding Clip
Tip To Tip: 42mm
Front To Back: 12mm
Height: 21mm
Ford F-150
2005 - On

UNIT PACKAGE: 15



21506

(Not Available From O.E.M.)
Black & White Nylon

Windshield Moulding Clip
With Sealer
Top Head Size: 13mm x 13.5mm
Bottom Head Size: 12mm x 14mm
Stem Length: 9mm
Explorer
2011 - On

UNIT PACKAGE: 10



20979

(6G1Z-5410182-C)
Blue Nylon

Wheel Flare & Rocker Panel
Moulding Clip
Top Head Size: 14mm x 18mm
Bottom Head Size 14mm x 18mm
Stem Length: 11mm
Fits Into 9mm Hole
Ford 500
2005 - ON

UNIT PACKAGE: 25



21202

(W790173-S900)
Blue Nylon

Windshield Moulding Clip
With Sealer
Top Head Size: 14mm x 18mm
Bottom Head Size: 19mm x 18mm
Stem Length: 10mm
Fits Into 9mm Hole
Flex
2009 - On

UNIT PACKAGE: 10



20817

(W710528-S300)
White Nylon

Moulding Clip
With Sealer
Top Head Size: 14mm x 20mm
Bottom Head Size: 15mm x 20mm
Stem Length: 12mm
Fits Into 9mm Hole
Lincoln Navigator
2003 - On

UNIT PACKAGE: 15



21198

(Not Available
From O.E.M.)
White Nylon

Door Cladding
Moulding Clip
With Sealer
Top Head Size: 15mm x 20mm
Bottom Head Size: 20mm x 24mm
Stem Length: 11mm
Fits Into 11mm Hole
Edge and Lincoln MKX
2007 - On

UNIT PACKAGE: 10



20867

(Not Available
From O.E.M.)
Purple Nylon

Rocker Panel Moulding Clip
With Sealer
Top Head Size:
9/16" x 25/32"
Bottom Head Size:
19/32" x 25/32"
Stem Length: 7/16"
Fits Into 7/16" Hole
Ford
2004 - On

UNIT PACKAGE: 15



21669

(W716497-S300)
Gray Nylon

Bumper Moulding Clip
With Sealer
Top Head Size: 12mm x 20mm
Bottom Head Size: 12mm x 24mm
Stem Length: 16mm
Escape
2013 - On

UNIT PACKAGE: 10



21668

(W715201-S300)
White Nylon

Rocker Panel Moulding Clip With Sealer
Top Head Size: 12mm x 20mm
Bottom Head Size: 15mm x 20mm
Stem Length: 15mm
Escape
2013 - On

UNIT PACKAGE: 15



21523

(Not Available From O.E.M.)
White Nylon

Rocker Moulding Clip With Sealer
Top Head Size: 14mm x 18mm
Bottom Head Size: 14mm x 18mm
Stem Length: 15mm
Fits Into 9mm Hole
Lincoln MKS
2010 - On

UNIT PACKAGE: 10



20968

(Not Available From O.E.M.)
Yellow Nylon

Wheel Lip Moulding Clip
Head Size: 15mm x 51mm
Stem Length: 11mm
Fits Into 10mm Hole
Expedition & Navigator
1998 - On

UNIT PACKAGE: 15



21174

(W713590-S300)
White Nylon

Windshield Moulding Clip With Sealer
Top Head Size: 14mm x 18mm
Bottom Head Size: 15mm x 18mm
Stem Length: 11mm
Fits Into 9mm Hole
Flex
2009 - On

UNIT PACKAGE: 15



20981

(Not Available From O.E.M.)
White Nylon

Wheel Flare Moulding Clip With Sealer
Top Head Size: 14mm x 29mm
Bottom Head Size: 14mm x 29mm
Stem Length: 16mm
Fits Into 9mm Hole
Explorer
2006 - On

UNIT PACKAGE: 15



21230

(Not Available From O.E.M.)
White Nylon

Fender Flare Moulding Clip
Top Head Size: 14mm x 34mm
Bottom Head Size: 14mm x 33mm
Stem Length: 14mm
Fits Into 9mm Hole
Explorer
2007 - On

UNIT PACKAGE: 25



21522

(Not Available From O.E.M.)
Gray Nylon

Fender & Rocker Moulding Clip With Sealer
Top Head Size: 14mm x 18mm
Bottom Head Size: 18mm x 21mm
Stem Length: 15mm
Fits Into 9mm Hole
Explorer
2011 - On

UNIT PACKAGE: 25



21009

(YL8Z-7820806-AA)
White Nylon

Body Side & Rocker Panel Moulding Clip
Top Head Size: 13mm x 25mm
Bottom Head Size: 13mm x 18mm
Stem Length: 10mm
Fits Into 9mm Hole
Escape
2001 - On

UNIT PACKAGE: 10



21148

(Not Available From O.E.M.)
White Nylon

Drip Rail Moulding Clip With Sealer
Width: 1-11/32"
Overall Height: 11/16"
500, Montego, Sable & Taurus
2005 - On

UNIT PACKAGE: 15



21000

(F57B-16241-AA)
White Nylon

Fender Moulding Clip
Head Size: 15mm x 51mm
Stem Length: 11mm
Fits Into 8mm Hole
Explorer & Others
2005 - On

UNIT PACKAGE: 15



19441

(F1TZ-7810182-A)
Black Nylon

Rocker Panel
Ground Effects
Moulding Clip
Explorer,
Expedition & F150
1991-On

UNIT PACKAGE: 25



21219

(Not Available From O.E.M.)
Yellow Nylon

Fender Flare
Moulding Clip
Top Head Size: 14.5mm x 33.5mm
Bottom Head Size: 15mm x 45mm
Stem Length: 14mm
Fits Into 11mm Hole
F-450 & F-550 Truck
2009 - On

UNIT PACKAGE: 10



20358

(F6DZ-5410182-AA)
Black Nylon

Rocker Panel Moulding Clip
Head Size: 13mm x 39mm
Stem Length: 14mm
Fits Into 9mm Hole
Sable, Taurus & Lincoln LS2000
1996 - On

UNIT PACKAGE: 10



20965

(F4ZZ-6310182-A)
Black Nylon

Rocker Panel and
Ground Effects
Moulding Clip
Head Size:
16mm x 50mm
Stem Length: 14mm
Fits Into 9mm Hole
Mustang
1995 - On

UNIT PACKAGE: 15



20977

(6G1Z-5410182-A)
Gray Nylon

Rocker Panel
Moulding Clip
Top Head Size:
22mm x 30mm
Overall Height: 18mm
Ford 500
2005 - On

UNIT PACKAGE: 15



20663

(F57Z-16241-AB,
W709767-S300)
Black Nylon

Rocker Panel
Moulding Clip
Head Size: 14mm x 40mm
Stem Length: 11mm
Ford Mustang
2001 - On

UNIT PACKAGE: 15



21319

(Not Available From O.E.M.)
White Nylon

Ground Effects
Moulding Clip
Head Size: 20mm x 40mm
Stem Length: 14mm
Overall Height: 30mm
Fits Into 9mm Hole
Ford
2008 - On

UNIT PACKAGE: 10



18498

(W700614S300)
Black Nylon

Door Trim Clip
Contour & Mystique
1995-On

UNIT PACKAGE: 10



17602
(F1CZ-61101B04-A)
Natural Nylon

Body Side & Rocker Panel
Moulding Clip
Escort GT 1991-On

UNIT PACKAGE: 15



18822
(Ford: KA80-51-RF5A)
Nylon

Body Side Garnish
Moulding Clip Mazda
Millenia & Ford Probe
1995-On

UNIT PACKAGE: 15



20392
(Not Supplied By O.E.M.)
White Nylon

Moulding Clip
Head Diameter: 3/4"
Stem Length: 15/32"
Fits Into 5/16" Hole
Ford Expedition, Explorer
& Mountaineer
2001 - On

UNIT PACKAGE: 10



20355
(W705849-S300)
Nylon

Front End Moulding Clip
Top Head Size: 1/2" x 13/16"
Bottom Head Size:
11/16" x 25/32"
Stem Length: 3/8"
Ford
2000 - On

UNIT PACKAGE: 10



20936
(Ford: W707388-S300;
Mazda: 9XG0-73-88X0)
Black Nylon

Front Bumper Cover
Moulding Clip
Bottom Head Size: 18mm x 20mm
Stem Length: 10mm
Fits Into 8mm x 12mm Hole
Ford Escape
2001 - On
Mazda Tribute 2006 - 01

UNIT PACKAGE: 10



19345
(W702412-S300)
Nylon

Pillar Trim Clip
Contour & Mystique
1995-On

UNIT PACKAGE: 50



18882
(Ford: KA80-51-PR6;
Mazda: EA01-50-048)
Black Nylon

Body Side Lower
Wide Moulding Grommet
Ford Probe & Mazda MX6
1993-On

UNIT PACKAGE: 10



19805
(W703507-S300)
Natural Nylon

Wheel Opening
Moulding Clip
Head Diameter: 18mm
Stem Length: 8mm
Focus
2000 - On

UNIT PACKAGE: 25



20306
(W703505-S301)
Zinc Organic

Wheel Opening
Pushnut Retainer
Retainer Diameter: 22mm
**Used With Auveco
Wheel Opening
Moulding Clip 19805**
Focus
2000 - On

UNIT PACKAGE: 25



19413
(F7UZ-15238A32)
Black Nylon

Door Panel Screw Cover
Head Diameter: 3/4" (19mm)
Fits Into 5/8" (16mm) Hole
Ford Econoline E150
1997 - On

UNIT PACKAGE: 25



20194
(W701223-S300)
Black Nylon

Cowl Grille Screw Cover
13mm O.D.
Use With Auveco Fastener 20193
Contour, Focus & Mystique
1995 - On

UNIT PACKAGE: 50



20193
(W703842-S300,
W703919-S300)
Black Nylon
w/ Zinc & Yellow Screw

Cowl Grille Fastener
Nylon Retainer
Length Under Head: 38mm
Replaces Auveco 18497
Contour, Focus & Mystique
1995 - On

UNIT PACKAGE: 15



14953

(Ford: N803494S;
GM: 15679091)
Black Nylon

Fascia, Trim & Grille
Retainer
Head Size: 15/32" x 15/32"
Stem Length: 21/32"
Fits Into 1/4" Square Hole or Slot
Aerostar, Escort & Lynx
1985-On
GM 1994 - On
UNIT PACKAGE: 25

Please Order In
Unit Package
Quantities not
Number Of Pieces



17060

(Ford: E92Z-17C756C;
Mazda: GJ21-50-034)
Black Nylon

Bumper Cover Retainer
Head Size: 20mm x 30mm
Stem Length: 20mm
Fits Into 10mm Hole
Ford Probe &
Mazda MX6 1989-On
UNIT PACKAGE: 10



14995

(GM: 10195515;
Ford: N805026S;
Chrys: 4696488,
6503163)
Black Nylon

Push-Type Retainer
Head Diameter: 1/2"
Stem Length: 1-13/64"
Fits Into 9/32" Hole
GM, Ford & Chrysler
1987 - On

UNIT PACKAGE: 25



17450

(Ford: E8BZ-17C756C,
Mazda: BF67-50-235)
Black Nylon

Bumper Cover Retainer
Head Size: 20mm x 30mm
Stem Length: 11mm
Fits Into 10mm Hole
Ford Festiva 1988-On
Mazda 323 1986-On
UNIT PACKAGE: 10



20923

(Ford: 3M8Z-1502316-A;
Mazda: GJ6E-50-715A)
Black Nylon

Cowl Vent
Push-Type Retainer
Head Size: 8.5mm x 12mm
Stem Length: 9mm
Fits Into 5mm Hole
Fusion, Milan & Zephyr
2006 - On
Mazda 5 & 6
2003 - On

UNIT PACKAGE: 15



21595

(Not Available
From O.E.M.)
Natural Nylon

General Purpose
Push-Type Retainer
Head Diameter: 12.7mm (1/2")
Stem Length: 31mm (1-7/32")
Fits Into 7mm (9/32") Hole
Universal

UNIT PACKAGE: 50



15366

(Ford: E7GZ-17A904-B;
Mazda: BF67-50-033)
Gray Nylon

Bumper Retainer
Head Size: 20mm x 30mm
Stem Length: 11mm
Fits Into 10mm Hole
Mercury Tracer 1987-On
UNIT PACKAGE: 10



14988

(N805229S)
Black Nylon

Push-Type Retainer
Head Diameter: 7/16"
Stem Length: 11/16"
Fits Into 15/64" Hole
Ford
1987 - On

UNIT PACKAGE: 25



21172

(W713202-S300,
W713445-S300)
Black Nylon

Bumper Push-Type Retainer
Head Diameter: 13mm
Stem Length: 18mm
Fits Into 8mm Hole
Fusion
2006 - On

UNIT PACKAGE: 15



14992

(Ford: N803946S;
Chrys: 6502871)
Black Nylon

Push-Type Retainer
Head Diameter: 19/32"
Stem Length: 29/32"
Fits Into 1/4" Hole
Ford & Chrysler 1987 - On

UNIT PACKAGE: 50



20191
(YS4Z-16K262-AA)
Black Nylon

Push-Type Retainer
Head Diameter: 16mm
Stem Length: 18mm
Fits Into 6mm Hole
Focus
2000 - On

UNIT PACKAGE: 25



18894
(N807578-S,
N808332-S)
Black Nylon

Trim Panel
Push-Type Retainer
Head Diameter: 11/16"
Stem Length: 3/4"
Fits Into 1/4" Hole

UNIT PACKAGE: 15



20545
(N811283-S)
Black Nylon &
Santoprene Rubber

Trim Panel
Push-Type Retainer
Head Diameter: 18mm
Stem Length: 18mm
Fits Into 6.3mm Hole
Ford Expedition & Navigator
1997 - On

UNIT PACKAGE: 25



18893
(N806322-S)
Black Nylon

Trim Panel
Push-Type Retainer
Head Diameter: 11/16"
Stem Length: 1/2"
Fits Into 1/4" Hole

UNIT PACKAGE: 15



14753
(GM: 20664092;
Ford: N804570S;
Chry: 4638136)
Black Nylon

Trim Retainer
Head Dia: 11/16"
Stem Length: 7/8"
Fits Into 1/4" Hole
Ford 1986-On
Chrysler 1998 - On

UNIT PACKAGE: 25



21098
(Ford: W706092-S300;
Chrysler: 6508197-AA)
Black Nylon

Front Air Shield,
Splash Guard &
Heat Shield
Push-Type Retainer
Head Diameter: 18mm
Stem Length: 18mm
Fits Into 6.4mm Hole
Ford Taurus 2008 - On
Dodge Ram 2006 - On

UNIT PACKAGE: 25



14991
(GM: 10139822; 25680782;
Ford: N808147S)
Black Nylon

Push-Type Retainer
Head Diameter: 11/16"
Stem Length: 11/16"
Fits Into 1/4" Hole
GM & Ford 1987 - On

UNIT PACKAGE: 25



18895
(N807577-S,
N808331-S)
Black Nylon

Trim Panel
Push-Type Retainer
Head Diameter: 11/16"
Stem Length: 1-3/32"
Fits Into 1/4" Hole
Aerostar & Windstar

UNIT PACKAGE: 15



20367
(W706713-S300)
Black Nylon

Bumper Cover
Push-Type Retainer
Head Diameter: 18mm
Stem Length: 18mm
Fits Into 8mm Hole
Ford Escape
2001 - On

UNIT PACKAGE: 25



17632
(Mazda: B092-51-833;
Ford: MB-455-56143,
W705845-S300; Hyundai:
86590-28000)
Black Nylon

Push-Type Retainer
Head Diameter: 18mm
Stem Length: 12mm
Fits Into 8mm Hole
Mazda & Ford Aspire

UNIT PACKAGE: 10



21089
(W710250-S300)
Black Nylon

Rear Bumper Push-Type Retainer
Head Diameter: 18mm
Stem Length: 18mm
Fits Into 8mm Hole
Edge
2007 - On

UNIT PACKAGE: 25

FasTrack Web
Auveco's Cost
Recovery System
For Repair Fasteners...

Never Lose Money On
Fasteners Again.



19849

(Not Available From O.E.M.)

Black Nylon & Santoprene Rubber

Bumper Push-Type Retainer
Head Diameter: 18mm
Stem Length: 18mm
Fits Into 8mm Hole
Taurus & Sable
2000 - On

UNIT PACKAGE: 25



13469

(N802737-S)
Black Nylon

Under Hood Retainer
Head Diameter 3/4"
Stem Length 1/2"
Fits Into 1/4" Hole
Tempo & Topaz

UNIT PACKAGE: 25



16858

(Nissan: 63844-01A00;
Ford: MNA01-56145,
NA01-56145; Kia:
MNA01-56-145; Mazda:
NA01-56-145)
Black Nylon

Push-Type Retainer
Head Dia: 20mm
Stem Length: 18mm
Fits Into 8mm Hole
Nissan 1980-On
Probe & Aspire 1995-On
Kia & Mazda

UNIT PACKAGE: 25



14994

(N804837S)
Black Nylon

Push-Type Retainer
Head Diameter: 1"
Stem Length: 29/32"
Fits Into 1/4" Hole
Ford 1987 - On

UNIT PACKAGE: 50



11702

(D6EA-1A100-AA)
Natural Nylon

Wheel Ornament
Push-Type Retainer
Head Diameter: 25/64"
Stem Length: 19/32"
Fits Into 9/32" Hole
Ford
1976 - On

UNIT PACKAGE: 50



11705

(387843-S)
Black Nylon

Fender Shield Retainer
Head Dia: 19/32"
Stem Length: 5/8"
Fits Into 1/4" Hole
Ford
1978-On

UNIT PACKAGE: 50



20310

(383142-S)
Black Nylon

Grille To
Headlight Bracket
Push-Type Retainer
Head Diameter: 5/8"
Stem Length: 7/16"
Fits Into 1/4" Hole
Replaces Auveco 10214
Ford

UNIT PACKAGE: 50



20273

(Ford: N808791;
Chrys: 5GC71RC3AA,
5GF92RC3AA)
Gray Nylon

Interior Trim, Dash & Console
Push-Type Retainer
Head Dia: 19mm
Shoulder Dia: 10mm
Shoulder Length: 7mm
Stem Length: 22mm
Fits Into 9mm Hole
Dodge Durango & Ford Pick-Ups
1997 - On

UNIT PACKAGE: 25



11706

(387944-S)
Black Nylon

Grille To Metal
Stamping Retainer
Head Dia: 3/4"
Shoulder Length: 1/4"
Stem Length: 11/16"
Fits Into 1/4" Wide Slot
Ford Truck
1978-On

UNIT PACKAGE: 50



20233

(W705956-S300)
Black Nylon

Cowl Push-Type Retainer
Head Diameter: 25mm
Shoulder Diameter: 10mm
Shoulder Length: 3mm
Stem Length: 12mm
Fits Into 9mm Hole
Lincoln LS
1999 - On

UNIT PACKAGE: 15



15522

(N805231S)
Black Nylon

Push-Type Retainer
Head Diameter: 5/8"
Stem Length: 17/32"
Fits Into 1/4" Hole
Taurus, Topaz & Sable
1989-On

UNIT PACKAGE: 50



19607

(XL3Z-17E971-AA)
Natural Nylon

Front Bumper Cover
Push-Type Retainer
Head Dia.: 16mm
Stem Length: 12mm
Fits Into 10mm Hole
F150 & F250 Trucks
1999-On

UNIT PACKAGE: 25



20516

(W706182-S300)
Black Nylon

Headlight Mounting
& Deck Lid
Push-Type Retainer
Head Diameter: 20mm
10mm Hex
Stem Length: 13mm
Fits Into 8mm Hole
Ford Expedition, Explorer
& Focus
2000 - On

UNIT PACKAGE: 25



19801

(GM: 21077123; Chrys:
6509103AA, Ford:
W705436-S300)
Black Nylon

Wheel Opening Moulding
Push-Type Retainer
Head Diameter: 19/32" (15mm)
Stem Length: 3/4" (19mm)
Fits Into 1/4" (6mm) Hole
Saturn
1991 - On
Ford 2002 - On
Chrysler 2010 - On

UNIT PACKAGE: 25



21024

(Ford: 5R3Z-54310D12-AAA,
6E5Z-7850980-AAA; Mazda:
GJ21-68-885B-02)
Black Nylon

Trim Panel
Push-Type Retainer
Head Diameter: 18mm
Stem Length: 10mm
Fits Into 6mm Hole
Fusion & Mustang
2005 - On
Mazda 1992 - On

UNIT PACKAGE: 15



19638

(Chrys: 4805405AA;
Ford:
1L5Z-17K826AA)
Black & White Nylon

Push-Type Retainer
Head Dia.: 34mm
Stem Length: 20mm
Fits Into 8mm Hole
Chrysler
1998-On
Ford Trucks
2005 - On

UNIT PACKAGE: 15



17222

(Ford: F3LY-14570-B;
GM: 21075686)
Black Nylon

Push-Type Retainer
Head Diameter: 15mm
Stem Length: 20mm
Fits Into 8mm Hole
Rocker Panel, Wheel Liner
& Air Inlet Duct Applications
Ford

GM Saturn 1991 - On

UNIT PACKAGE: 25



18206

(GJ21-68885-B69)
Gray Nylon

Push-Type Retainer
Head Diameter: 18mm
Stem Length: 12mm
Fits Into 6mm Hole
Probe & Mazda MX6
1989-On

UNIT PACKAGE: 25



16726

(N808048S,
W705532-S300)
Black Nylon

Front Bumper
Stone Deflector
Retainer
Head Dia: 18mm
Stem Length: 18mm
Fits Into 6.3mm (1/4")
Square Hole
Bronco, Ranger
& Explorer 1989-On

UNIT PACKAGE: 25



17478

(Mazda: B101-68-252-00)
Black Nylon

Interior Trim
Push-Type Retainer
Head Diameter: 14mm
Stem Length: 16mm
Fits Into 6mm Hole
Ford Probe and
Mazda MX6
1988-On

UNIT PACKAGE: 25



17103

(GM: 15681408;
Ford: N803709S)
Black Nylon

Fascia Attachment
Push-Type Retainer
Head Dia: 15mm
Stem Length: 23mm
Fits Into 6mm Hole
GM & Ford 1986-On

UNIT PACKAGE: 50



20989

(GM: 11589291;
Ford: W713331-S300)
Black Nylon

Air Dam & Grille
Push-Type Retainer
Head Diameter: 18mm
Stem Length: 22mm
Panel Range:
7.0mm - 9.5mm
Fits Into 6.5mm Hole
GM 2003 - On
Ford

UNIT PACKAGE: 25



13993

(Ford: N803362-S;
GM: 20510029,
Chry: 34202672)
Black Nylon

Body Retainer
Head Dia: 11/16"
Stem Length: 7/8"
Fits Into 1/4" Hole
Ford, GM & Chrysler
1984 - On

UNIT PACKAGE: 25



14018
(N803716-S)
Black Nylon

Fascia Retainer
Head Dia: 18mm
Stem Length: 23mm
Fits Into 7mm Hole
Mustang/Capri
1985-On

UNIT PACKAGE: 25



20632
(GM: 11518017,
Ford: W708530-S300)
Black Nylon

Bumper Cover &
Fender Shield
Push-Type Retainer
Head Diameter: 20mm
Stem Length: 26mm
Fits Into 8mm Hole
GM & Ford
1997 - On

UNIT PACKAGE: 15



19244
(N808847-S)
Black Nylon

Trunk Trim Panel
Push-Type Retainer
Head Diameter: 1"
Stem Length: 11/16"
Fits Into 1/4" Square Hole
Taurus & Sable
1996-On

UNIT PACKAGE: 25



17216
(GM: 21030249;
Ford: N807389S;
Chry: 6503598)
Nylon

Air Baffle To
Under Carriage
Push-Type Retainer
Head Diameter: 20mm
Stem Length: 20mm
Fits Into 8mm Hole

UNIT PACKAGE: 25



20993
(GM: 11589295;
Ford: W712665-S300)
Black Nylon

Fender, Flare, Gas Tank
& Panel Attachment
Push-Type Retainer
Head Diameter: 25mm
Stem Length: 20mm
Panel Range:
3.0mm - 6.0mm
Fits Into 10.5mm Hole
GM 2005 - On
Ford

UNIT PACKAGE: 25



14020
(Ford: N802781-S;
GM: 14093088)
Black Nylon

Splash Shield & Fascia Retainer
Head Dia: 1"
Stem Length: 7/8"
Fits Into 1/4" Hole

UNIT PACKAGE: 25



20889
(GM: 11589293; Ford:
W712196-S300)
Black Nylon

Cowl Vent & Fender
Push-Type Retainer
Head Diameter: 20mm
Stem Length: 22mm
Panel Range:
4.5mm - 7.0mm
Fits Into 8.5mm Hole
GM 1997 - On
Edge, Fusion,
Lincoln MKX, Milan
And Zephyr
2006 - On

UNIT PACKAGE: 25



15701
(N804674-S)
Black Nylon

Push-Type Retainer
Head Dia: 25mm
Stem Length: 27mm
Fits Into 7mm Hole
Mustang & Capri

UNIT PACKAGE: 50

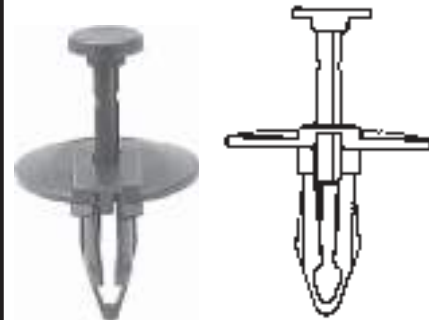

14019
(Ford: N803421-S,
Chry: 6501590)
Black Nylon

Splash Shield & Fascia Retainer
Head Dia: 1"
Shoulder Length: 1/8"
Stem Length: 7/8"
Fits Into 5/16" Hole

UNIT PACKAGE: 25

**Take The Guesswork
Out Of Identifying
Clips and Fasteners
With Auveco Display Boards**



13994

(GM: 20570245;
Ford: N804614S)
Black Nylon

Spare Tire Retainer
Head Dia: 1"
Stem Length: 7/8"
Fits Into 5/16" Hole

UNIT PACKAGE: 25



20518

(W705957-S300,
W706519-S300)
Black Nylon

Radiator Sight Shield
Push-Type Retainer
Head Diameter: 24.5mm
Stem Length: 14mm
Fits Into 9mm Hole
Lincoln LS
2000 - On

UNIT PACKAGE: 10



19511

(W704958-S300)
White Nylon

Rear Door
Lower Trim Panel
Push-Type Retainer
Round Head Diameter: 19/32"
Wedge Shaped Head
Diameter: 29/32"
Stem Length: 11/16"
Fits Into 3/8" Hole
Lincoln Town Car
1998 - On

UNIT PACKAGE: 25



18503

(W701054-S300)
Black Nylon

Front Bumper
Push-Type Retainer
Head Diameter: 1"
Stem Length: 1"
Fits Into 5/16" Hole
Contour & Mystique
1995-On

UNIT PACKAGE: 25



20169

(W701971-S)
White Nylon

Door Trim Panel
Push-Type Retainer
Head Diameter: 15mm
Stem Length: 13mm
Fits Into 7mm Hole
Lincoln LS
2000 - On

UNIT PACKAGE: 25



20970

(Not Available
From O.E.M.)
Black Nylon

M14 x 34mm
Bumper and Door Insulator
Nylon Screw
22mm Head O.D.
No. 3 Square Drive
Fits Into 12mm Hole
GM, Ford & Chrysler
2005 - On

UNIT PACKAGE: 25



19337

(N808908-S)
Black Nylon

Headlight Accessory
Push-Type Retainer
Head Diameter: 14mm
Stem Length: 23mm
Fits Into 6.3mm (1/4") Hole
Mustang
1996 - On

UNIT PACKAGE: 10



20363

(Not Available
From O.E.M.)
White Nylon

Door Trim Panel
Push-Type Retainer
Top Head Diameter: 15mm
Bottom Head
Diameter: 20mm
Overall Length: 32mm
Fits Into 9mm Hole
Ford
2001 - On

UNIT PACKAGE: 25



19472

(GM: 25535963;
Ford: N811772S)
Nylon

Upper Deflector Shield

UNIT PACKAGE: 25



9426

(C7AB-14A163-B)

Horn Wire Retainer
Tube Size 1/4"
Ford

UNIT PACKAGE: 50



18386
(W701133-S300)
Black Nylon

Routing Clip
Contour & Mystique
1995-On

UNIT PACKAGE: 25



17164
(E0VY-13A506-A)
Nylon

Rear Light
Wiring Retainer
3/8" Wide, 1-7/16" Long
Stem: 9/32" x 7/16" Long
Ford
1979-On

UNIT PACKAGE: 50



20482
(2F1Z-9A317-AA)
Natural Nylon

Fuel Line Retainer Clip
For 5/16" Fuel Line
Ford Taurus & Mercury Sable
6 Cylinder 3.0 L Engine
With Fuel Injection
2002 - On

UNIT PACKAGE: 25



14217
(GM: 1257702,
20346654;
Ford: 383207-S
AMC: 3693099)
Nylon

Routing Clip

UNIT PACKAGE: 25



20569
(E9DB-14A163CA,
F1TZ-14A163E)
Natural Nylon

Wiring Routing Clip
Head Size: 10mm x 31mm
Stem Diameter: 7mm
Stem Length: 11mm
Ford
1989 - On

UNIT PACKAGE: 25



17643
(N802239-S,
N806191-S1901)
Natural Nylon

Fuel Line Retainer Clip
For 5/16" Fuel Line
Ford (With Fuel Injection)
1980-On

UNIT PACKAGE: 25

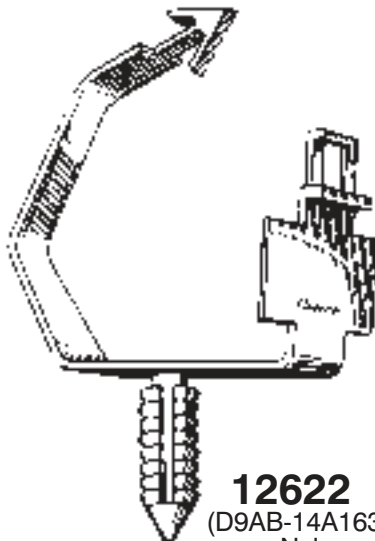

12622
(D9AB-14A163JC)
Nylon

Wire Routing Clip
Stem: 5/16" x 3/4" Long
Ford 1980-On

UNIT PACKAGE: 25

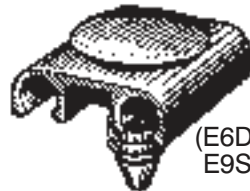

15524
(E6DC-2B223AA,
E9SC-2B223AA)
Nylon

Clip Assembly
For Brake Tube
Length: 1"
Holds 3/16" O.D. Tube
Fits Into 1/4" Hole
Cougar XR7 & T-Bird

UNIT PACKAGE: 10



17642
(N802241-S,
N806190-S1901)
Black Nylon

Fuel Line Retainer Clip
For 3/8" Fuel Line
Ford (With Fuel Injection)
1980-On

UNIT PACKAGE: 25



20483
(2F1Z-9A317-BA)
Black Nylon

Fuel Line Retainer Clip
For 3/8" Fuel Line
Ford Taurus & Mercury Sable
6 Cylinder 3.0 L Engine
With Fuel Injection
2002 - On

UNIT PACKAGE: 25



21127
(7L3Z-9S317-B)
Pink Nylon

Fuel Line Clip
Fits 3/8" Fuel Line
F Series Pick-Up
2004 - On

UNIT PACKAGE: 5



21214
(4F1Z-9A317-AA)
White Nylon

Fuel Line Retainer Clip
For 5/16" Fuel Line Hose
Head Size: 3/8" x 5/8"
Overall Height: 21/32"
Taurus
2004 - On

UNIT PACKAGE: 15



18504
(W702380-S300)
Yellow Nylon

Hood Prop Rod Clip
Fits 6mm Rod
Contour & Mystique
1995-On

UNIT PACKAGE: 5



18387
(91GBA611A08BEAW)
Nylon

Headrest Clamp
Contour & Mystique
1995-On

UNIT PACKAGE: 10



21126
(7L3Z-9S317-A)
Pink Nylon

Fuel Line Clip
Fits 5/16" Fuel Line
F Series Pick-Up
2004 - On

UNIT PACKAGE: 5

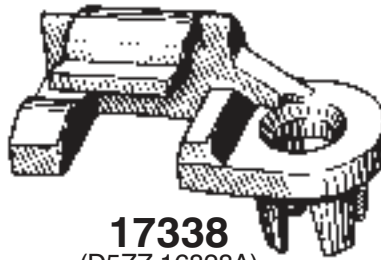

17338
(D5ZZ-16828A)
Nylon

Hood Prop Rod Clip
7/32" Rod Diameter
Ford/Mercury Bobcat, Cougar,
Fairmont, Granada, Monarch,
Mustang, Pinto, Thunderbird,
Zephyr & E100/350
1991-75

UNIT PACKAGE: 15



18102

(Ford: N806624-S191;
Chry: 6502776)

Rear Light Assembly
Retainer
Ford Explorer
1991-On

UNIT PACKAGE: 25



21445
(1R3Z-18D434-BA)
Gray Nylon

Heater Hose Coupler Retainer
For Use With 3/4" Heater Hose
Overall Height: 3/4"
Mustang 2004 - 01 and
F250 - F550 Truck
2007 - 03

UNIT PACKAGE: 10



19536
(F65Z-15020C34-AA)
Black Nylon

Cowl Vent Plug
Head Diameter: 21/32"
Expedition & F150/250
1996 - On

UNIT PACKAGE: 25



17613
(N802190-S53)
Phosphate

Wheel Ornament Retainer Nut
M4.2-1.81 (#8) Screw Size
Aerostar, Bronco II,
Explorer & Ranger
1983-On

UNIT PACKAGE: 100



16954
(386299-S)
Nylon

Hood Prop Rod Clip
5/16" Rod Diameter
Ford Cars
1975-On

UNIT PACKAGE: 25



10837
(D3AA-90826-AA)
Nylon

Speed Control Rod to
Throttle Pivot
Ford

UNIT PACKAGE: 10



14820
(N803685S)

Dash Panel Nut
Screw Size: #8 (M4.2-1.41)
Taurus/Sable

UNIT PACKAGE: 25



19823

(N806511-S32)
Phosphate & Olive Drab

Parking Light Retainer Nut
Screw Size: #8 (M4.2 - 1.41)
Ford Vans
1997 - On

UNIT PACKAGE: 25



20546

(N808342-S307)
Black Phosphate

Air Cabin Filter Fastener
Size: 5/8" x 25/32"
Ford Taurus & Sable
1995 - On

UNIT PACKAGE: 50



14895

(Ford: N803638-S36B)

Top Vent Grille (Water Deflector)
Mounting Clip
Escort & Lynx
1984-On

UNIT PACKAGE: 25



19677

(N804741-S2)
Black Phosphate

Instrument Panel Fastener
Use With 5/16"
Tapping Screw
Head Size: 9/16" x 5/8"
Overall Length: 1"
LTD, Mercury
Marquis & Trucks
1996 - On

UNIT PACKAGE: 10



14819

(N803968-S100)

Bumper Strip Retainer
25/32" Long, 9/32" Wide
Taurus/Sable

UNIT PACKAGE: 50



13472

(Ford: 386285,
AMC: 3230375)
Nylon

Air Cleaner Wing Nut
Self Threading
1/4", 6mm
Ford and AMC

UNIT PACKAGE: 10



12606

(E1EB-61046A48-BA)

Lower Finish Panel Clip
Ford 1981-On

UNIT PACKAGE: 25



19838

(Not Available From O.E.M.)
Dacromet 320

Front Bumper
Chrome Strip Fastener
Size: 5/8" x 1"
Flange Size: 7/32" x 1"
Grip Range: .039" - .098"
(1mm - 2.5mm)
Ford Explorer
1999 - On

UNIT PACKAGE: 10



20396

Zinc & Yellow

1/4" - 20 Specialty Insert
Grip: .030" - .165"
Head Diameter: 1/2"
Hex Size: 3/8"

**Can be set with
Auveco Tool 11805**

UNIT PACKAGE: 15



17003

(Ford: F32Z-17C756-S
Mazda: GJ21-50-049)

Bumper Cover Retainer
Front & Rear Bumpers
Ford Festiva and
Mazda
1988 - On

UNIT PACKAGE: 50



19421

(F7UZ-1513284-BA)
Zinc Organic

Front Door Scuff
Plate Retainer
Econoline Van
E150/350
1997-On

UNIT PACKAGE: 25



20421

(N811257-S100)
Zinc & Olive Drab

M5-.8 Specialty Insert With Sealer
Grip: .5mm-2.5mm,
Head Diameter: 10mm,
Hex Size: 7mm
General Purpose
Ford Escape, Excursion, Expedition,
Explorer, Navigator & Mountaineer
2001 - On

**Can be set with
Auveco Tool 11805**

UNIT PACKAGE: 15



20678

Zinc & Yellow

M5-.8 Specialty Insert
Grip: .5mm-3.3mm
Head Diameter: 10mm
Hex Size: 7mm
**Can be set with
Auveco Tool 11805**

UNIT PACKAGE: 15



20415

(GM: 15685099;
Ford: N803763-S100)
Zinc & Yellow

M6-1.0 Specialty Insert With Sealer
Grip: .65mm - 2.0mm
Head Diameter: 12mm
Hex Size: 8mm
Roof Rack, Tailgate
& General Purpose
GM APV Vans, C & K Trucks
And Ford Explorer
1991 - On

**Can be set with
Auveco Tool 11805**

UNIT PACKAGE: 15



20153

(YL3Z-1521970-AA)

White Door Lock Pawl
Right-Hand Side
Ford Continental, Contour,
Explorer, Mountaineer,
Mystique, Ranger, Sable
& Taurus And Mazda Truck
1996 - On

UNIT PACKAGE: 1



20401

(W706172-S309,
W708384-S309)
Zinc & Yellow

M6-1.0 Specialty Insert With Sealer
Grip: .5mm-4.2mm
Head Diameter: 13mm
Hex Size: 9.5mm (3/8")
Roof Rack
Ford Escape, Excursion, Expedition,
Explorer, Navigator & Mountaineer
2000 - On

**Can be set with
Auveco Tool 11805**

UNIT PACKAGE: 15



19436

(N808182-S309)
Zinc & Yellow

Roof Rack
Mounting Nut Insert
M6 - 1.0 Thread
Grip: .7mm - 3.17mm
Head Diameter: 13mm
Explorer & Expedition
1997-On

**Can Be Set With
Auveco Tool 11805**

UNIT PACKAGE: 10



20195

(YL3Z-1521971-AA)

Pink Door Lock Pawl
Left-Hand Side
Ford Continental, Contour,
Explorer, Mountaineer,
Mystique, Ranger, Sable
& Taurus And Mazda Truck
1996 - On

UNIT PACKAGE: 1



21215

(W710791-S437)
Zinc

Quarter Glass & Luggage Rack
Specialty Insert
With Sealer
Thread: M6-1.0
Grip: .51mm - 3.18mm
Head Diameter: 13mm
Hex: 9.5mm (3/8")
**Can be set with
Auveco Tool 11805**
Expedition & Navigator
2007 - On

UNIT PACKAGE: 15



20776

(W708513-S437)
Zinc

M8-1.25 Specialty Insert
Grip: .7mm - 3.8mm
Head Diameter: 22mm
Hex Size: 12.7mm (1/2")
Frame Area
Ford Trucks
2004 - On

UNIT PACKAGE: 15



17118

(E6DZ-5421971-A,
F3LY-6321971A)
Nylon

Door Lock Pawl
Left-Hand Side
Ford Taurus & Sable 1986-On

UNIT PACKAGE: 10



17119

(E6DZ-5421970-A,
F3LY-6321970-A)
Nylon

Door Lock Pawl
Right-Hand Side
Ford Taurus & Sable 1986-On

UNIT PACKAGE: 10



20630
(F8DZ-54265A99-AA)
White Nylon

Door Latch Guide
Width: 23mm
Length: 36mm
Taurus & Sable
1998 - On

UNIT PACKAGE: 15



Right-Hand Side Left-Hand Side

10262
Nylon

Door Lock Rod & Hood
Latch Locking Push Rod Clip
Rod Size: 5/32"
Fits Into 1/4" Hole
Chrysler, Ford, GM & AMC
UNIT PACKAGE: 20 Pieces

10 Rights - 10 Lefts

20675

(AMC: 4003672R;
Chry: 2945108R, 4658676;
GM: 16627328;
Ford: N805350S)
White Nylon

Clip For Right-Hand Side Only

UNIT PACKAGE: 25

14967

(AMC: 4003673L;
Chry: 2945109L, 4658677;
GM: 9815325, 16607593;
Ford: D2VZ-6521952A, N804344S)
Black Nylon

Clip For Left-Hand Side Only

UNIT PACKAGE: 50



15675
(E6AZ-5421952-A,
390523S)
Yellow Nylon

Door Lock Rod Clip
5/32" Rod Size
Ford Products
1986-On

UNIT PACKAGE: 25

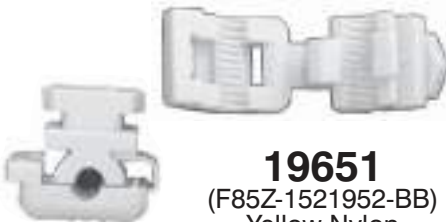

19651
(F85Z-1521952-BB)
Yellow Nylon

Door Lock Rod Clip
Expedition & Navigator
F150, 250
1997 - On

UNIT PACKAGE: 10



17122
(E6DZ-5421952A,
E83Z-5421952B)
White Nylon

Door Lock Rod End Clip
5/32" Rod Size
Taurus, Sable, Tempo, Topaz, T-Bird &
Cougar, Aerostar, Bronco, Explorer,
Mountaineer, Pick-Up, Ranger &
Windstar
1986-On

UNIT PACKAGE: 10



18914
(Not Supplied
By O.E.M.)
PVC Plastic

Door Lock Striker Bushing
1/2" I.D., 11/16" O.D.
7/8" Long
Ford
1972-On

UNIT PACKAGE: 50



18890
(3W7Z-5422008-AA,
6W1Z-5422008-A,
E9FZ-5822008-A,
F67Z-7822008-AA,
XW1Z-5422008-AA)

Door Lock Striker
Bolt Assembly
M10-1.50 Thread
Ford, Lincoln & Mercury
1980-On

UNIT PACKAGE: 1



18891
(E9AZ-5422008-A;
XW1Z-5822008-AA)

Door Lock Striker Bolt Assembly
7/16-14 Thread
Ford, Lincoln & Mercury
1983-On

UNIT PACKAGE: 1

**Body Hardware &
Specialty Fasteners
= Auveco**



18892

(D2AZ-6522008-A)

Door Lock Striker
Bolt Assembly
7/16"-14 Thread
Cars 1980-73
E100/350 Vans
(Back Door) 1986-80

UNIT PACKAGE: 1

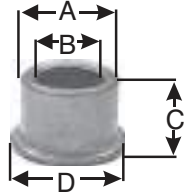

Door Hinge Bushings

Auveco Part No.	Dimensions			
	O.D. "A"	I.D. "B"	Height "C"	Flange O.D. "D"
14550	27/64"	11/32"	19/64"	19/32"
14551	31/64"	11/32"	19/64"	19/32"



14550

(D1AZ-6522841A)

Ford 1973-On

UNIT PACKAGE: 25



14551

(D90Z-6522841A)

Ford 1973-On

UNIT PACKAGE: 25



19594

(D9ZZ-6643030-AA)

Zinc Plated

Door Hinge Pin
Pin Diameter: 11/32"
Length Under Head: 3-3/8"
Head Diameter: 9/16"
Mustang 1993 - 79
Tempo & Topaz 1994 - 90
Capri 1986 - 80

UNIT PACKAGE: 10



20346

(Not Available From O.E.M.)
Zinc & Yellow

Door Hinge Pin
Length: 3-1/2"
Pin Dia: 11/32"
Knurl Dia: .358"
Head O.D.: 9/16"
Use With Auveco 8829 E-Type Retaining Ring
Ranger, F150, F250 & F350
1998 - 80

UNIT PACKAGE: 5



13030
(E2GZ-6723342A)
Black Nylon

Window Crank Handle

UNIT PACKAGE: 1



12470
(D1FZ-6222600-A,
D2FZ-6222600-A)

Door Handle

UNIT PACKAGE: 1

HELPFUL HINTS..... FOR USING THE Auveco Catalog

1. **The color-coded pages** signify various sections:
Blue-Metric Items
Beige-Electrical Accessories
Green-Assortments, Cabinets, Bins & Racks
Gray-Key Blanks & Accessories
Pink-Import Car Body Hardware
2. Most pictures and illustrations are actual size.
3. We have **Specification Charts** for:
Body Bolts (pages 20 & 49-50)
Special Tapping Screws (pages 23-26 & 54-57)
License Plate Screws (pages 33-34)
"Xmas Tree" Retainers (pages 404-413)
Push-Type Retainers (pages 450-460)
4. We have **three different indexes** in the front of the catalog to assist you.
Pictorial Quick Index
Alphabetical Index
Numerical Index
5. There are two **OEM Part Number To Auveco Part Number Cross References** at the back of the catalog.



11371
(3691599)

#12-28 x 1-1/2"
Headlight
Adjusting Screw
& Nut Assembly
Chrysler
1975-On

UNIT PACKAGE: 10



13466
(6032516)

Black Nylon
License Plate Nut
#12 Screw Size
Chrysler

UNIT PACKAGE: 25



21632

(Mitsubishi: MU480001)
Natural Nylon

M3.5 (#6) Screw Size
Head Size: 10mm x 10mm
Stem Length: 7mm
Fits Into 6mm x 6mm Hole
Chrysler Avenger, Colt,
Jeep Eagle Talon, Laser
& Sebring and Mitsubishi Eclipse
2000 - 1984

UNIT PACKAGE: 50

Please Order In Unit
Package Quantities
Not Number Of Pieces



10760
(3574085)
Gray Nylon

#12-28 x 1-1/2"
Headlight Adjusting Screw
& Nut Assembly
Chrysler
1972 - On

UNIT PACKAGE: 10

11653

Same as 10760 except packing

UNIT PACKAGE: 25

11654

Same as 10760 Except Packing

UNIT PACKAGE: 100



14800
(6500725)

Black Nylon
Headlight Bezel Nut
#10 Screw Size
Chrysler 1983-On

UNIT PACKAGE: 50



19485
(6027958)

Natural Nylon
License Plate Nut
& Door Lock
Remote Control
Switch Bracket Nut
#14 (1/4") Screw Size
Fits Into 3/8" x 3/8" Hole
Chrysler 1984-On

UNIT PACKAGE: 10



9377

(Chry: 6000943;
AMC: 8934-201-263)
White Nylon

Radiator Grille Nut
#8 Screw Size
Chrysler & AMC-Renault

UNIT PACKAGE: 100



12569

(Ford: N801706-S;
Chry: 6501773)
Black Nylon

#12 Screw Size

UNIT PACKAGE: 25



12735

(GM: 1370853;
Chry: 6029501;
VW: 179-813-883)
Natural Nylon

Headlight Bezel Nut
#6 Screw Size

UNIT PACKAGE: 50



21236

(6508072-AA)
Black Nylon

Headlight Nylon Nut
M5.5 (#12) Screw Size
Head Size: 15mm x 15mm
Stem Length: 10mm
Fits Into 10.5mm x 11mm Hole
Jeep Grand Cherokee &
Commander
2005 - On

UNIT PACKAGE: 50



10305

Nylon

Nylon Nut
#8 Screw Size

UNIT PACKAGE: 50



8419
(2524525)

Natural Nylon

Headlight Bezel Nut
#8 or #10 Screw Size
Chrysler

UNIT PACKAGE: 50



18034
(6503108)
Black Nylon

Luggage Compartment Trim
Nylon Nut
#8 Screw Size
Chrysler Concorde & LHS,
Dodge Intrepid & Eagle Vision
1993-On

UNIT PACKAGE: 25



14756
(Chry: 6033677;
Ford: 379830-S)
Black Nylon

3/8" Wide, 3/8" Long
Fits Into 9/32" x 9/32" Hole
Panel Thickness: 1/4"
#8 Screw Size
Chrysler & Ford
1986-On

UNIT PACKAGE: 25



19785
(4805119)
Natural Nylon

Cowl Vent Nylon Nut
#10 (M4.8) Screw Size
LH, Neon & 300M
1998 - On

UNIT PACKAGE: 25



19640
(6505161AA)
White Nylon

Bumper Fascia Grommet
Screw Size: M4.2 (#8)
Head Dia.: 14mm x 18mm
Snaps Into a 9mm x 11mm Hole
LH & LHS Series
1998-On

UNIT PACKAGE: 25



13647
(6031234)
White Nylon

Radiator Grille Nut
#8 Screw Size
Chrysler

UNIT PACKAGE: 25



20179
(6035401)
Green Nylon

Door Trim Panel
Nylon Nut
M4.2 (#8) Screw Size
Head Size: 16mm x 16mm
Stem Length: 10mm
Caravan, Town & Country
and Voyager
1996 - On

UNIT PACKAGE: 25



20267
(6505703AA)
Tan Nylon

Tail Light
Nylon Nut
Head Size: 5/8" x 5/8"
Stem Length: 3/8"
#8 (M4.2) Screw Size
Jeep Grand Cherokee
2000 - On

UNIT PACKAGE: 15



11308
White Nylon

Nylon Nut
#8 or #10 Screw Size

UNIT PACKAGE: 50



14218
(6031183)
Black Nylon

#6 or #8 Screw Size
Chrysler

UNIT PACKAGE: 50



11720
White Nylon

Grille Nut
#8 or #10 Screw Size
Chrysler 1976-On

UNIT PACKAGE: 50



19793
(6504072)
Black Nylon

Tail Light Housing Grommet
Head Diameter: 16mm
Stem Length: 10mm
Snaps Into 12mm Hole
Dakota & Ram Trucks
1997 - On

UNIT PACKAGE: 25



12566
(Chry: 6032061;
GM: 25508532)
Black Nylon

Grille
Attachment Grommet
Chrysler & GM
1981-On

UNIT PACKAGE: 25



12713
(Chry: 6031869;
GM: 1264963;
AMC: 8934-201-602)
Natural Nylon

High Torque Screw Grommet
Chrysler, GM & AMC-Renault

UNIT PACKAGE: 25



19276
(34201872,
8934-201-872)
Natural Nylon

Door Trim Panel
& Cowl Grille Seal
Screw Grommet
#4 or #6 Screw Size
Jeep Cherokee, Grand Cherokee,
Comanche & Grand Wagoneer
1991-On

UNIT PACKAGE: 25



14037
(GM: 15596280;
Chry: 6035274)
Black Nylon

Cowl Vent Nut
#6 or #8 Screw Size

UNIT PACKAGE: 25



20667
(4860375-AB)
White Nylon

Cowl Vent Grommet
M4.8 (#10) Screw Size
Head Size: 14mm x 20mm
Caravan, Town & Country
And Voyager Mini-Vans
2004 - On

UNIT PACKAGE: 50



20275
(Not Supplied
By O.E.M.)
White Nylon

Door Panel Grommet
Head Dia: 19mm
Stem Length: 12mm
Fits Into 9mm Hole
Use With Auveco 20274
LH Series
2000 - On

UNIT PACKAGE; 25



19642
(4805336AA)
White Nylon

Bumper Fascia Grommet
Head Dia.: 10mm x 15mm
Snaps Into 9mm x 12mm Hole
Concorde, Intrepid
& Eagle
1998-On

UNIT PACKAGE: 25



20524
(6035821)
Black Nylon

Door Panel & Fender Shield
Screw Grommet
#8 Screw Size
Head Size: 1/2" x 21/32"
Stem Length: 7/16"
Dodge Vans, Durango & Sebring
1996 - On

UNIT PACKAGE: 25



20468
(6506852-AA)
Green Nylon

Trim Panel Grommet
Head Dia.: 17mm
Stem Length: 12mm
Fits Into 8mm Hole
Sebring & Stratus
2001 - On

UNIT PACKAGE: 50



21025
(MB645307)
Black Nylon

Back Glass Lower Moulding,
Quarter Glass Moulding &
Spoiler Grommet With Sealer
Head Size: 12mm x 16mm
Stem Length: 14mm
Dodge Avenger & Stealth and
Chrysler Sebring
and Mitsubishi
1991 - On

UNIT PACKAGE: 15



17354
(6501699)
Black Nylon

Cowl Screen Nut
#8 Screw Size
Chrysler Mini-Vans & Cars
1990-On

UNIT PACKAGE: 25



21231
(4784018-AA)
Green Nylon

Door Panel Grommet
Head Diameter: 19mm
Stem Length: 12mm
Fits Into 9mm Hole
Use With Auveco #20274
Chrysler LH Series
2000 - On

UNIT PACKAGE: 25



20769
(4857751AA)
Natural Nylon

Tail Light Grommet
Head Size: 17mm x 19mm
Overall Length: 21.5mm
Chrysler Pacifica
2004 - On

UNIT PACKAGE: 25



18825
(6503373)
Black Nylon

Cowl & Dash Panel
Screw Grommet
#8 Screw Size
Cirrus & Stratus
1995-On

UNIT PACKAGE: 15



21213
(Not Available From O.E.M.)
Black Nylon

Tail Light Assembly Grommet
Head Diameter: 19mm
Stem Length: 11mm
Fits Into 12mm Hole
Dodge Pick-Ups
1500 & 2500 Series
2006 - On

UNIT PACKAGE: 25



20525
(Not Available
From O.E.M.)
Black Nylon

Headlight Mounting
Panel Grommet
Head Size: 16mm x 22mm
Stem Length: 20mm
Jeep Grand Cherokee
1999 - On

UNIT PACKAGE: 25

**For The Most
Up-To-Date
Information On New
Items Available From
Auveco, refer to the
"Hot New Items"
Section of the Auveco
Web Site
(www.auveco.com)**



20356
(4759514AB)
Black Rubber

Rubber Grommet
Head Diameter: 15mm
Stem Length: 11mm
Fits Into 9mm Hole
Floor Pan Plug &
Luggage Compartment Carpet
LH, LHS & Concorde
1997 - On

UNIT PACKAGE: 50



20581
(MR478263)
Black Rubber

Bumper Cover &
Garnish Moulding Grommet
With Sealer
Head Diameter: 16mm
Stem Length: 20mm
Fits Into 9mm Hole
Use With Auveco 20580
Sebring & Stratus
And Mitsubishi Eclipse
2000 - On

UNIT PACKAGE: 15



20962
(55156879-AB)
Black Nylon

Tail Light Grommet
Head Size: 20mm x 31mm
Receives 10mm Ball Stud
Jeep Commander
2006 - On

UNIT PACKAGE: 25



19809
(6504870AA)
Natural Nylon

Nylon "U" Nut
M4.2 (#8) Screw Size
Panel Range: 1mm - 4.25mm
Center Of Hole To Edge: 10mm
LH & 300M
1998 - On

UNIT PACKAGE: 25



20964
(5159077-AA)
Black Nylon

Rear Bumper Clip
Stem Length: 15/32"
Overall Length: 31/32"
Jeep Grand Cherokee
2005 - On

UNIT PACKAGE: 25



17195
(Isuzu: 8942180270)
Black Nylon

Grille Clip
13mm Wide
22mm Long
Ford Escort, Honda, Isuzu,
Mitsubishi & Plymouth Laser

UNIT PACKAGE: 25



13843
(6003861)
Nylon

Deck Lid
Moulding Clip
Chrysler
1984-On

UNIT PACKAGE: 25



12794
(6003609)
Nylon

Roof Side Moulding Clip
Chrysler
1977-On

UNIT PACKAGE: 50

**Please Order
In Unit Package
Quantity
Not Pieces**



13927
(6003774,
6003965)
Nylon

Body Side Moulding Clip
Chrysler
1981-On

UNIT PACKAGE: 25



13616
(6003219)
Nylon

Moulding Clip
Chrysler
1971-On

UNIT PACKAGE: 25

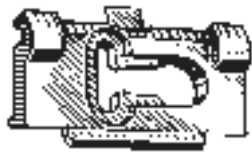

13847
(6003858)
Nylon

Deck Lid Moulding Clip
Chrysler Vans
1984-On

UNIT PACKAGE: 25



17064
(6004162)
Nylon

Woodgrain Side
Moulding Clip
Dodge Caravan &
Plymouth Voyager
Mini-Vans
1990-On

UNIT PACKAGE: 25



19894
(5FR56DX9)
Black Nylon

Rocker Panel Clip
Head Size: 7/16" x 25/32"
Stem Length: 5/8"
Jeep Grand Cherokee
1999 - On

UNIT PACKAGE: 25



11936
(6003632)
Nylon

Wheel Opening Moulding Clip
Chrysler
1978-On

UNIT PACKAGE: 50



13845
(6003873)
Nylon

Body Side & Back Door
Moulding Clip
Chrysler Vans
1984-On

UNIT PACKAGE: 50



20523
(55156429-AA)
Black Nylon

Rocker Panel &
Bumper Fascia Clip
Top Head Size:
1/2" x 1-3/16"
Stem Length: 27/32"
Jeep Liberty
2002 - On

UNIT PACKAGE: 10



11354
(6003147)
Nylon

Moulding Clip
Chrysler
1976-On

UNIT PACKAGE: 25



17151
(6004036)
Nylon

Window Reveal Moulding Clip
Chrysler LeBaron & Maserati
1987-On

UNIT PACKAGE: 15



21154
(5189180-AA)
Black Nylon

Front Fender Flare (Front)
Moulding Clip
Top Head Size: 13mm x 31mm
Bottom Head Size: 14mm x 22mm
Stem Length: 22mm
Jeep Commander
2006 - On

UNIT PACKAGE: 15

**HELPFUL HINTS.....
FOR USING THE Auveco Catalog**

The catalog has five **Specification Charts** to help identify the correct fastener:

- Body Bolts** (pages 20 & 49-50)
- Special Tapping Screws** (pages 23-26 & 54-57)
- License Plate Screws** (pages 33-34)
- "Xmas Tree" Retainers** (pages 404-413)
- Push-Type Retainers** (pages 450-460)



20828
(55157070-AC)
Black Nylon

Rocker Moulding Clip
Head Diameter: 25mm
Overall Length: 31mm
Fits Into 8mm Hole
Jeep Liberty
2002 - On

UNIT PACKAGE: 10



20763
(1BA41AX1-AA)
Black Nylon

Rocker Panel
Moulding Clip
Head Size: 12mm x 20mm
Stem Length: 13mm
Chrysler 300 & Dodge Magnum
2005 - On

UNIT PACKAGE: 15



20982
(Not Available
From O.E.M.)
White Nylon

Fender & Wheel Flare
Moulding Clip
Top Head Size: 14mm x 18mm
Bottom Head Size: 17mm x 21mm
Stem Length: 13mm
Fits Into 9mm Hole
Jeep Commander
2006 - On

UNIT PACKAGE: 25



20827
(55157069-AB)
White Nylon

Rocker Moulding Clip
Top Head Size: 14mm x 27mm
Bottom Head Size: 13mm x 26mm
Stem Length: 15mm
Fits Into 9mm Hole
Jeep Liberty
2002 - ON

UNIT PACKAGE: 25



21175
(1BA41XWG-AA)
Cream Color Nylon

Rocker Panel
Moulding Clip
Head Size: 12mm x 20mm
Stem Length: 13mm
Fits Into 9mm Hole
Chrysler 300
2006 - On

UNIT PACKAGE: 15



21223
(6509288AA)
Black Nylon

Rocker Moulding Clip
With Sealer
Upper Head Size: 21mm x 22mm
Bottom Head Size: 22mm x 22mm
Stem Length: 9mm
Chrysler Grand Caravan
and Town & Country
2008 - On

UNIT PACKAGE: 10



21153
(6508947-AA)
Black Nylon

Front Bumper
Moulding Clip
Top Head Size: 11mm x 32mm
Bottom Head Size: 15mm x 20mm
Stem Length: 20mm
Fits Into 15mm Hole
Jeep Patriot
2007 - On

UNIT PACKAGE: 10



21670
(4389940-AB)
Black Nylon

Rocker Panel
Moulding Clip
Head Size: 10mm x 20mm
Stem Length: 14mm
Chrysler Sebring &
Dodge Avenger
2007 - On

UNIT PACKAGE: 10



21099
(Not Available From O.E.M.)
White Nylon

Lift Gate Moulding Clip
With Sealer
Top Head Size: 12mm x 21mm
Bottom Head Size: 16mm x 18mm
Stem Length: 11mm
Magnum 2006 - On

UNIT PACKAGE: 10



20870
(Not Available
From O.E.M.)
White Nylon

Rocker Panel
Moulding Clip
Top Head Size: 9/16" x 13/16"
Bottom Head Size: 9/16" x 23/32"
Stem Length: 5/8"
Dodge Dakota & Durango
And Jeep Liberty
2000 - On

UNIT PACKAGE: 15



21666
(Not Available
From O.E.M.)
White Nylon

Liftgate Spoiler
Moulding Clip
With Sealer
Top Head Size: 12mm x 23mm
Bottom Head Diameter: 18mm
Stem Length: 11mm
Chrysler and Dodge Mini-Van
2008 - On

UNIT PACKAGE: 15



20700
(55156447-AB)
Black Nylon

Ground Effects
Moulding Clip
Head Width: 1/2"
Head Length: 1-1/2"
Stem Length: 1/2"
Jeep Liberty
2004 - On

UNIT PACKAGE: 25



21528
(68039280-AA)
Black Nylon

Fender Flare & Rocker Moulding Clip
Top Head Size: 14mm x 38mm
Bottom Head Size: 16mm x 38mm
Stem Length: 14mm
Fits Into 10mm Hole
Jeep Wrangler JK & Wrangler Unlimited JK
2007 - On

UNIT PACKAGE: 25



20887
(55157055-AA, 55157065-AA)
Gray Nylon

Fender Flare Moulding Clip
Top Head Size: 14mm x 38mm
Bottom Head Size: 16mm x 38mm
Stem Length: 15mm
Fits Into 9mm Hole
Jeep Liberty
2005 - On

UNIT PACKAGE: 15



21155
(5189181-AA)
Black Nylon

Front Fender Flare (Rear) Moulding Clip With Sealer
Top Head Size: 14mm x 40mm
Bottom Head Size: 14mm x 18mm
Stem Length: 15mm
Jeep Commander
2006 - On

UNIT PACKAGE: 10



20771
(4857699-AA)
Black Nylon

Front Bumper Fascia To Grille Retainer
Head Size: 10mm x 42mm
Stem Length: 14mm
Fits Into 7.5mm Hole
Chrysler Pacifica
2004 - On

UNIT PACKAGE: 25



18029
(4630253)
Black Nylon

Rear Fascia Push-Type Retainer
Head Size: 7/8" x 1-25/32"
Stem Length: 1-1/16"
Fits Into 1/2" Hole
Chrysler Concorde & LHS
Dodge Intrepid & Eagle Vision
1993-On

UNIT PACKAGE: 15



19131
(Not Available From O.E.M.)
Black Nylon

Cowl Screen Retainer
Chrysler New Yorker, Intrepid, LHS, Concorde & Eagle Vision
1993-On

UNIT PACKAGE: 15



18032
(6502573)
Black Nylon

Cowl Screen Attachment Push-Type Retainer
Head Size: 15/32"
Stem Length: 9/16"
Fits Into 1/4" Square Hole
Chrysler Concorde & LHS, Dodge Intrepid & Eagle Vision
1993-On

UNIT PACKAGE: 15



17214

(GM:10089262, 21042098; Chry: 55075139)
Black Nylon

Push-Type Retainer
Head Dia: 11mm (7/16")
Stem Length: 18mm (11/16")
Fits Into 6mm (15/64") Hole
GM Saturn

4 Door & Station Wagon
1991 - On

UNIT PACKAGE: 25

14987

Same As 17214 Except Packing

UNIT PACKAGE: 50



14995

(GM: 10195515; Ford: N805026S; Chrys: 4696488, 6503163)
Black Nylon

Push-Type Retainer
Head Diameter: 1/2"
Stem Length: 1-13/64"
Fits Into 9/32" Hole
Ford, GM & Chrysler
1987 - On

UNIT PACKAGE: 25



21595

(Not Available From O.E.M.)
Natural Nylon

General Purpose Push-Type Retainer
Head Diameter: 12.7mm (1/2")
Stem Length: 31mm (1-7/32")
Fits Into 7mm (9/32") Hole
Universal

UNIT PACKAGE: 50



14992

(Ford: N803946S;
Chrys: 6502871)
Black Nylon

Push-Type Retainer
Head Diameter: 19/32"
Stem Length: 29/32"
Fits Into 1/4" Hole
Ford & Chrysler 1987 - On

UNIT PACKAGE: 50



19140

(Acura:
90505-SL0-003;
GM: 94852368;
Mitsubishi:
MB888869; Toyota:
90467-08155)
Black Nylon

Push-Type Retainer
Head Diameter: 20mm
Stem Length: 21mm
Fits Into 8mm Hole
Acura, Dodge Avenger,
Eagle Talon, Geo Prizm,
Mitsubishi Eclipse & Galant
and Toyota
1993-On

UNIT PACKAGE: 5



11704

(6031383)
Black Nylon

Grille Retainer
Head Diameter: 11/16"
Stem Length: 7/16"
Fits Into 9/32" Hole
Chrysler
1978-On

UNIT PACKAGE: 25



15672

(8880417)
Black Nylon

Push-Type Retainer
Head Diameter: 17mm
Stem Length: 14mm
Fits Into 8mm (5/16") Hole
Chrysler 1987-On

UNIT PACKAGE: 25



16835

(GM: 10140480;
Chry: 6502625)
Black Nylon

Push-Type Retainer
Head Dia: 21mm (27/32")
Shoulder Length: 3mm (1/8")
Stem Length: 25mm (1")
Fits Into 12mm (1/2") Hole

UNIT PACKAGE: 25



11699

(GM: 472434;
Chry: 6031390)
Black Nylon

Cowl Ledge
Weatherstrip & Fender Liner
Push-Type Retainer
Head Dia: 11/16"
Stem Length: 5/8"
Fits Into 1/4" Hole
GM 1970-On
Chrysler 1968-On

UNIT PACKAGE: 50



14753

(Chry: 4638136;
GM: 20664092;
Ford: N804570S)
Black Nylon

Radiator Shroud &
Trim Retainer
Push-Type Retainer
Head Dia: 11/16"
Stem Length: 7/8"
Fits Into 1/4" Hole
Chrysler 1998 - On
GM 1982 - On
Ford 1986 - On

UNIT PACKAGE: 25



20273

(Ford: N808791;
Chrys: 5GC71RC3AA,
5GF92RC3AA)
Gray Nylon

Interior Trim, Dash & Console
Push-Type Retainer
Head Dia: 19mm
Shoulder Dia: 10mm
Shoulder Length: 7mm
Stem Length: 22mm
Fits Into 9mm Hole
Dodge Durango &
Ford Pick-Ups
1997 - On

UNIT PACKAGE: 25



21098

(Chrysler: 6508197-AA;
Ford: W706092-S300)
Black Nylon

Front Air Shield,
Splash Guard &
Heat Shield
Push-Type Retainer
Head Diameter: 18mm
Stem Length: 18mm
Fits Into 6.4mm Hole
Dodge Ram 2006 - On
Ford Taurus 2008 - On

UNIT PACKAGE: 25



17104

(6501630,6501772,
6501878)
Black Nylon

Headlight & Tail Light
Panel Attachment
Push-Type Retainer
Head Size: 15mm x 31mm
Stem Length: 17mm
Fits Into 5mm x 6.5mm Hole
Dodge Daytona 1987-On

UNIT PACKAGE: 10



20739

(WX68DX9-AA)
Black Nylon

Door Trim Panel
Push-Type Retainer
Head Diameter: 22mm
Stem Length: 10mm
Fits Into 9mm Hole
Chrysler 300 & Dodge Magnum
2005 - On

UNIT PACKAGE: 25



21021
(0WX68BD5-AA)
Dark Gray Nylon

Door Trim Panel
Push-Type Retainer
Head Diameter: 22mm
Stem Length: 10mm
Fits Into 9mm Hole
Charger,
Magnum & 300M
2005 - On

UNIT PACKAGE: 25



21427
(0WX68XDB-AA)
Light Gray Nylon

Door Trim Panel
Push-Type Retainer
Head Diameter: 22mm
Stem Length: 10mm
Fits Into 9mm Hole
Chrysler 300M, Charger & Magnum
2005 - On

UNIT PACKAGE: 25



20948
(0WX68BD1-AA)
Tan Nylon

Door Trim Panel
Push-Type Retainer
Head Diameter: 22mm
Stem Length: 10mm
Fits Into 9mm Hole
Chrysler 300M and Dodge
Charger & Magnum
2005 - On

UNIT PACKAGE: 25



17080
(OH452KD5)
Nylon
Quartz
Matte Finish

Headliner Retainer
Head Dia: 1-1/4"
Stem Length: 7/16"
Fits Into 1/4" Hole
Dodge Caravan &
Plymouth Voyager 1984-On

UNIT PACKAGE: 15



12567
(GM: 14019205,
14019206, 16514113;
Chry: 34201621, 6504090)
Black Nylon

Front Fender Mud Skirt
& Fender Liner
Push-Type Retainer
Head Dia: 11/16"
Stem Length: 9/16"
Fits Into 1/4" Hole
GM 1981 - On
Chrysler

UNIT PACKAGE: 25

14007

Same as 12567 except packing
UNIT PACKAGE: 50



18327
(6503454)
Black Nylon

Front Bumper Fascia
Push-Type Retainer
Head Diameter: 11/16"
Stem Length: 5/8"
Fits Into 1/4" Hole
Jeep Grand Cherokee
1994-On

UNIT PACKAGE: 25



14010
(GM: 14045480;
Chry: 6508746-AA)
Black Nylon

Fascia Retainer
Head Dia: 1"
Stem Length: 23/32"
Fits Into 3/8" Hole
GM 1982 - On
Chrysler 2009 - On

UNIT PACKAGE: 25

**For the most up-to-date
information on new items
available from Auveco, refer to
the "Hot New Items" section of
the Auveco web site
(www.auveco.com)**



14016
(GM: 16500308;
Chry: 6500787)
Black Nylon

Tail Light Retainer
Large Head Diameter: 3/8"
Stem Length: 7/16"
Fits Into 3/16" Hole
GM & Chrysler

UNIT PACKAGE: 25



20580
(MR478262)
Black Nylon

Bumper Cover &
Garnish Moulding
Push-Type Retainer
Top Head Diameter: 15mm
Bottom Head Diameter: 14mm
Stem Length: 12mm
Fits Into 7mm Hole
Use With Auveco 20581
Sebring & Stratus
And Mitsubishi Eclipse
2000 - On

UNIT PACKAGE: 15



14963
(4248294,
F155DT3)
Light Palomino
Nylon

Interior Trim
Push-Type Retainer
Large Head Diameter: 13mm
Stem Length: 7mm (Exc. the pin)
Fits Into 7mm Square Hole
Chrysler 1987 - On

UNIT PACKAGE: 25



19801
(GM: 21077123;
Chrys: 6509103AA
Ford: W705436-S300)
Black Nylon

Wheel Opening Moulding
Push-Type Retainer
Head Diameter: 19/32" (15mm)
Stem Length: 3/4" (19mm)
Fits Into 1/4" (6mm) Hole
Saturn 1991 - On
Ford 2002 - On
Chrysler 2010 - On

UNIT PACKAGE: 25



19639

(GM: 15149708;
Chrys: 6506008AA)
Black Nylon

Radiator, Wheelhouse,
Fender & Front Bumper Cover
Push-Type Retainer
Head Diameter: 17mm
Stem Length: 16mm
Fits Into 6mm Hole
GM C & K Trucks 1999 - On
Jeep Liberty 2002 - On

UNIT PACKAGE: 25



20988

(GM: 11589289;
Chrysler: 6508863-AA)
Black Nylon

Air Distributor &
Windshield Defroster
Push-Type Retainer
Head Diameter: 18mm
Stem Length: 17.5mm
Panel Range: 2.0mm - 4.5mm
Fits Into 6.5mm Hole
GM 2002 - On
Chrysler

UNIT PACKAGE: 25



19422

(6504521)
Black Nylon

Fascia
Push-Type Retainer
Large Head Dia.: 23/32"
Stem Length: 29/32"
Fits Into 5/16" Hole
LHS, Concorde,
Intrepid & Eagle Vision
1998-On

UNIT PACKAGE: 25



18030

(Chry: 6501925;
GM: 10134407)
Black Nylon

Push-Type Retainer
Head Size: 11/16"
Stem Length: 13/16"
Fits Into 1/4" Hole
Chrysler Concorde & LHS
Dodge Intrepid & Eagle Vision
1993-On
Coolant Recovery Reservoir
GM 1992-On

UNIT PACKAGE: 25



20966

(5160260-AA)
Black Nylon

Rear Bumper, Tail Light
And Fender
Push-Type Retainer
Bottom Head Diameter: 18mm
Stem Length: 20mm
Fits Into 8mm Hole
Dodge Caliber and
Jeep Compass & Patriot
2007 - On

UNIT PACKAGE: 15



20768

(4806240AA)
Black Nylon

Rear Bumper
Push-Type Retainer
Large Head
Diameter: 18.5mm
Stem Length: 21mm
Fits Into 8mm Hole
Chrysler 300 & Dodge
Magnum
2005 - On

UNIT PACKAGE: 10



13993

(GM: 20510029;
Ford: N803362-S;
Chry: 34202672)
Black Nylon

Body Retainer
Head Dia: 11/16"
Stem Length: 7/8"
Fits Into 1/4" Hole
GM 1984-On
Ford 1984 - On
Chrysler 1984 - On

UNIT PACKAGE: 25



20888

(GM: 11561368;
Chrys: 6508712AA)
Black Nylon

Fender, Wheel & Bumper
Push-Type Retainer
Head Diameter: 18mm
Stem Length: 20mm
Panel Range: 3.0mm - 5.8mm
Fits Into 9.5mm Hole
GM 2004 - On
Jeep Wrangler
2000 - On

UNIT PACKAGE: 25



20990

(GM: 15296830;
Chrysler: 5116530-AA)
Black Nylon

Fascia &
General Purpose
Push-Type Retainer
Head Diameter: 19mm
Stem Length: 16mm
Panel Range: 5.0mm - 7.0mm
Fits Into 8mm Hole
GM 2007 - On
Chrysler

UNIT PACKAGE: 25



19245
(5BB14LX9)
Black Nylon

Fascia To Front Bumper
Push-Type Retainer
Large Head Dia.: 3/4"
Stem Length: 1-1/8"
Fits Into 1/4" Hole
Dodge Dakota
1994-On

UNIT PACKAGE: 25



21086
(Mercedes-Benz:
230-990-01-92;
Chrys: 6104900-A)
Black Nylon

Hood Insulation & Cowl Grille
Push-Type Retainer
Head Diameter: 20mm
Stem Length: 10mm
Fits Into 8mm Hole
Mercedes GL, M, R,
SL & SLK
2005 - On
Chrysler 2010 - On

UNIT PACKAGE: 15



20766
(6507669-AA)
Black Nylon

Radiator Grille
Push-Type Retainer
Head Diameter: 20mm
Stem Length: 16mm
Fits Into 10mm Hole
Dodge Durango
2004 - On

UNIT PACKAGE: 25



20458
(6506132-AA)
Black Nylon

Side Radiator Shield
Push-Type Retainer
Head Dia.: 20mm
Stem Length: 17mm
Fits Into 7mm Hole
Sebring & Stratus
2001 - On

UNIT PACKAGE: 25



17216
(GM: 21030249;
Ford: N807389S;
Chry: 6503598)
Black Nylon

Air Baffle To
Under Carriage
Push-Type Retainer
Head Diameter: 20mm
Stem Length: 20mm
Fits Into 8mm Hole

UNIT PACKAGE: 25



20457
(4857345-AA)
Black Nylon

Tail Light Housing
Push-Type Retainer
Large Head
Dia.: 21mm
Stem Length: 23mm
Fits Into 9.5mm Hole
Caravan
Town & Country And
Voyager Mini Vans
2002 - On

UNIT PACKAGE: 25



20967
(Not Available
From O.E.M.)
Black Nylon
Rear Bumper
Mounting Bracket
Push-Type Retainer
Head Diameter: 22mm
Stem Length: 16mm
Fits Into 10mm Hole
Jeep Commander
2006 - On

UNIT PACKAGE: 15



21601
(06509673AA)
White & Black Nylon

Push-Type Retainer
With Sealer
Top Head Diameter: 16mm
Middle Head Diameter: 18mm
Bottom Head Diameter: 22mm
Stem Length: 16mm
Fits Into 9mm Hole
Chrysler 300 & Magnum
and Jeep Grand Cherokee
& Wrangler
2011 - On

UNIT PACKAGE: 15



18269
(6503106)
Black Nylon

Lower Sill
Moulding
Push-Type Retainer
Large Head Dia.: 7/8"
Stem Length: 1"
Fits Into 1/4" Hole
Jeep Grand Cherokee
Laredo 1994-On

UNIT PACKAGE: 15



20767
(4806110-AA)
Black & White Nylon

Front Bumper
Push-Type Retainer
Head Diameter: 24mm
Shoulder Length: 3mm
Stem Length: 20mm
Fits Into 11mm Hole
Chrysler 300 & Dodge Magnum
2005 - On

UNIT PACKAGE: 15

**Please E-mail
Your New Item
Suggestions To
Mail@auveco.com**



21376
(4389947-AA)
Black & White Nylon

Bumper Cover
Push-Type Retainer
With Sealer
Head Diameter: 24mm
Shoulder Length: 3mm
Stem Length: 20mm
Fits Into 11mm Hole
Avenger, Journey & Sebring
2008 - On

UNIT PACKAGE: 10

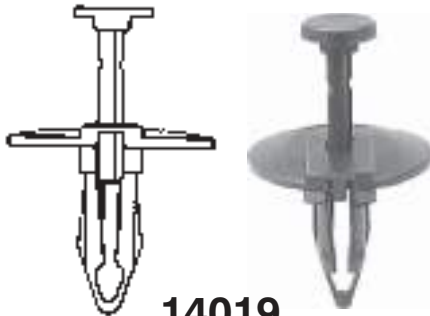

14019

(Ford: N803421-S;
Chry: 6501590)
Black Nylon

Push-Type Retainer
Head Dia: 1"
Shoulder Length: 1/8"
Stem Length: 7/8"
Fits Into 5/16" Hole

UNIT PACKAGE: 25



18394

(6503453)
Black Nylon

Fascia To Bumper
Push-Type Retainer
Large Head Dia.: 1"
Stem Length: 1-1/8"
Fits Into 1/4" Hole
Jeep Grand Cherokee
1994 - On

UNIT PACKAGE: 25



20940
(55157330-AC)
Black Nylon

Tail Light
Push-Type Retainer
Large Head
Diameter: 31mm
Small Head
Diameter: 20mm
Stem Length: 21mm
Fits Into 8mm
Square Hole
Jeep Commander
2006 - On

UNIT PACKAGE: 15



21348

(6508643-AA)
Black Nylon

Tail Light
Push-Type Retainer
Large Head Diameter: 31.5mm
Small Head Diameter: 20mm
Stem Length: 23mm
Fits Into 10mm Hole
Dodge Nitro and Jeep
2008 - On

UNIT PACKAGE: 15



20963

(4806334-AA)
Black & White
Nylon

Rear Bumper
Push-Type Retainer
With Sealer
Head Diameter: 34mm
Shoulder Length: 3.5mm
Stem Length: 17mm
Fits Into 8.5mm Hole
Dodge Caliber and
Jeep Compass & Patriot
2007 - On

UNIT PACKAGE: 10



19638

(Chrys:
4805405AA;
Ford:
1L5Z-17K826AA)
Black & White
Nylon

Front Bumper Fascia
Push-Type Retainer
Head Dia.: 34mm
Stem Length: 20mm
Fits Into 8mm Hole
Concorde, Intrepid, Eagle
Pacifica & PT Cruiser
1998-On
Ford Trucks
2005-On

UNIT PACKAGE: 15



20890

(55157112-AA, -AB)
Black & Natural
Nylon

Bumper Cover
Push-Type Retainer
Head Size: 25mm x 45mm
Shoulder Length: 3mm
Stem Length: 20mm
Fits Into 9.5mm Hole
Jeep Liberty
2005 - On

UNIT PACKAGE: 15

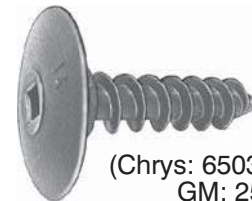

19417

(Chrys: 6503819, 6503401;
GM: 25631448)
Black Nylon

M7.5 x 35mm
Square Drive Truss Head
22mm Head Diameter
9mm Shoulder Diameter
Foam To Bumper Fascia
Chrysler
1993 - On
GM 1997 - On

UNIT PACKAGE: 15



20970

(Not Available From O.E.M.)
Black Nylon

M14 x 34mm
Bumper and Door Insulator
Nylon Screw
22mm Head O.D.
No. 3 Square Drive
Fits Into 12mm Hole
GM, Ford & Chrysler
2005 - On

UNIT PACKAGE: 25



18237

(6502545)
Nylon

Headlight Side
Shield Retainer
Dodge Daytona
1992-On

UNIT PACKAGE: 25



21442

(68033794-AA)
Black Nylon

Bumper Retainer
Head Diameter: 35mm
Stem Length: 14mm
Overall Height: 28mm
Jeep Grand Cherokee
2008 - On

UNIT PACKAGE: 15



13465

(4275973)
Nylon

Air Cleaner
Wing Nut
1/4"-20
Chrysler

UNIT PACKAGE: 10



18267

(32000404)
White Nylon

Brake Line
Retainer Clip
Dodge Van With
Anti-Lock Brakes
1994-On

UNIT PACKAGE: 10



14985

(2664040)
White Nylon

Door Weatherstrip to
Inside Panel Clip
Chrysler Corp. 1966-On

UNIT PACKAGE: 100

Not Actual Size



21310

(Not Available From O.E.M.)
Black Nylon

Cable Strap
Overall Length: 174mm (6-15/16")
Maximum Bundle Diameter:
40mm (1-9/16")
Strap Width: 5mm (3/16")
Chrysler
2007 - On

UNIT PACKAGE: 25



18249

(6503339)
Black Nylon

Cowl Top Stud Retainer Cover
Head Diameter: 13/16"
Dodge Ram
1994-On

UNIT PACKAGE: 25



20623

(Chrysler:
6506306-AA)
Black Nylon

Cowl Screen Retainer
Head Diameter: 25mm
T-30 Torx® Drive
Stem Length: 14mm
Fits On To 1/4" - 20 Bolt
Dodge Dakota
1997 - On

UNIT PACKAGE: 15



20420

(6505863-AA)
Black Nylon

Wire Routing Clip
Holds 3/16" (5mm) Diameter Wire
Stem Diameter: 5/16"
Stem Length: 9/32"
Flange Diameter: 25/32"
Mini-Vans
2002 - On

UNIT PACKAGE: 15



14858

(3799089)

Windshield Wiper Linkage Bushing
Replaces worn wiper
linkage bushing
thus eliminating wiper lag
Chrysler
1974-On

UNIT PACKAGE: 25



20312
(GM: 15021761;
Chry: 5027550AB)
Yellow Nylon

Hood Prop Rod Clip
7mm Rod Diameter
Snaps Into 10mm Hole
GM Cars & Trucks
Chrysler PT Cruiser
Isuzu Hombre
1990 - On

UNIT PACKAGE: 10



15674
(3454221,
4658677)
Green Nylon

Door Lock Rod Clip
Used On
Left-Hand Side
Rod Size: 5/32"
Chrysler 1972 - On

UNIT PACKAGE: 50



20307
(Not Supplied
By O.E.M.)
Black Nylon

Sliding Door Lock Rod Clip
Used On Left-Hand Side
Rod Size: 5mm
Fits Into 7mm Hole
Full-Size Vans
1997 - On

UNIT PACKAGE: 10



21034
(6506804-AA)
White Nylon

Door Lock Rod Clip
Right-Hand Side
Rod Size: 3mm (1/8")
Chrysler Mini-Vans
2002 - On
Dodge Caliber & Jeep Compass
2007 - On

UNIT PACKAGE: 15



Right-Hand Side Left-Hand Side

10262
Nylon

Door Lock Rod & Hood
Latch Locking Push Rod Clip
Rod Size: 5/32"
Fits Into 1/4" Hole
Chrysler, Ford, GM & AMC

UNIT PACKAGE: 20 Pieces
10 Rights - 10 Lefts

20675

(AMC: 4003672R;
Chry: 2945108R, 4658676;
GM: 16627328;
Ford: N805350S)
White Nylon

Clip For Right-Hand Side Only

UNIT PACKAGE: 25

14967

(AMC: 4003673L;
Chry: 2945109L, 4658677;
GM: 9815325, 16607593;
Ford: D2VZ-6521952A, N804344S)
Black Nylon

Clip For Left-Hand Side Only

UNIT PACKAGE: 50



20308
(Not Supplied
By O.E.M.)
Black Nylon

Sliding Door Lock Rod Clip
Used On Right-Hand Side
Rod Size: 5mm
Fits Into 7mm Hole
Full-Size Vans
1997 - On

UNIT PACKAGE: 10



19191

(4658444)
Lavender Nylon

Door Lock Rod Clip
Right-Hand Side
Rod Size: 1/8"
Chrys. Neon, Cirrus,
Stratus & Jeep Cherokee
1995-On

UNIT PACKAGE: 25



10080

(6027924)

Radiator Grille
Panel Upper
Support Baffle Retainer
Chrysler

UNIT PACKAGE: 100



15673
(3454220,
4658676)
Red Nylon

Door Lock Rod Clip
Used On Right-Hand Side
Rod Size: 5/32"
Chrysler 1972 - On

UNIT PACKAGE: 50



19152

(6031875)

Grille Bar Clip
Chrysler
1981-On

UNIT PACKAGE: 50



19310

(6034336, 6034812, 6035807)
Phosphate

Door Panel Nut
#6 Screw Size
Cirrus,
Concorde,
Intrepid, LHS,
Stratus &
Eagle Vision
1993-On

UNIT PACKAGE: 25



19519

(GM: 16662182;
Chrys: 6502988)
Zinc Organic

Front Bumper, Grille Mounting
& Headlight Cover Fastener
Width: 1/2"
Height: 9/16"
Chrysler Sebring
1996 - On
GM
1993 - On

UNIT PACKAGE: 15



19339

(4676356)
Phosphate

Grille To Fascia Fastener
Width: 1/2"
Height: 23/32"
Town & Country,
Caravan and Voyager
1997-On

UNIT PACKAGE: 15



20526

(4805570-AA)
Black

Radiator Grille
Cover Fastener
26mm Wide, 26mm Long
Caravan, Town & Country
And Voyager Mini-Vans
1996 - On

UNIT PACKAGE: 10



19794

(6503174)
Phosphate

Cowl, Pillar &
Door Panel Fastener
Width: 7/16"
Length: 19/32"
Mini-Vans
& Jeep Cherokee
1996 - On

UNIT PACKAGE: 25



16729

(4198993)

Door Window Opening
Moulding Clip
Dodge & Plymouth
Daytona,
Pacifica, Shelby & Laser
1984-On

UNIT PACKAGE: 50



18102

(Ford: N806624-S191;
Chry: 6502776)

Rear Light Assembly Retainer

UNIT PACKAGE: 25



19779

(6503812, 6504601)
Zinc & Yellow

Wheel Opening Moulding Nutsert
M5 - .8 Thread
Head Diameter: 10mm
**Can Be Set With
Auveco 11805 Tool**
Overall Length: 12mm
Jeep 1999 - On

UNIT PACKAGE: 15



20173

(6506104AA)
Zinc & Yellow

Roof Rack Nutsert
With Sealer Under Head
M6-1.0 Thread
Grip: .7mm - 3.2mm
Head Diameter: 17mm
9.5mm (3/8") Hex
**Can Be Set With
Auveco Tool 11805**
Jeep 1999 - On

UNIT PACKAGE: 10



21019

(6509106-AA)
Zinc

M6-1.0 Thread Specialty
Insert With Sealer
Grip Range: .70mm - 3.17mm
Head Diameter: 17mm
Hex Size: 9.5mm
Luggage Rack & Bumper
Fascia
Chrysler Jeep & Van
**Can only be set with
Pneumatic Tool**

UNIT PACKAGE: 15



17167

(4336115)

Door Hinge Bushing
Front & Rear Doors
Aries, Caravelle, LeBaron, Reliant,
Town & Country and 600
1989-85
O.D.: 3/8"
I.D.: 1/4"
Length: 13/32"
Flange O.D.: 1/2"

UNIT PACKAGE: 25



17434

(2486468)

Door Hinge Bushing
Chrysler Vans
1982-78
O.D.: 27/64"
I.D.: 11/32"
Length: 7/16"
Flange O.D.: 19/32"

UNIT PACKAGE: 25



14552

(4033711)

Door Hinge Bushing
Cargo doors, lift gates,
rear doors and fold-up rear seat
floor hinges on Dodge &
Plymouth vans, Ramcharger
and Trailduster
1970-On
O.D.: 5/16"
I.D.: 17/64"
Length: 23/64"
Flange O.D.: 33/64"

UNIT PACKAGE: 25

Dodge Truck Door Hinge Bolt & Bushing Repair Kit

For 2003 – 1994 Dodge Ram 1500, 2500 & 3500 Pick-Up Trucks

Why bother with the hassle of cutting and grinding off a worn door hinge and welding on a new one when you can repair the bad hinge in a fraction of the time?

With our Door Hinge Bolt & Bushing Repair Kit, fixing sagging doors caused by worn hinges due to pin or bushing failure is quick. It's easy. It works. And you don't have to paint the welded heat flash area.

Each kit is designed to repair one hinge and contains one zinc and yellow dichromate plated grade 8 bolt, two self-lubricating brass alloy bushings, one zinc plated spin lock nut and one zinc plated internal lock washer.

Here's how easy it is:

1. Remove the door from the truck body.
2. Grind or cut off the end of the pin at the peened end.
3. Remove the old pin and bushings.
4. Install the bushings into the hinge holes.
5. Place the washer on the bolt and install the bolt into the bushings.
6. Thread the nut onto the bolt and tighten.
7. Reattach the door to the truck body.



20544

Door Hinge Bolt & Bushing Repair Kit

Detailed instructions are included with the kit.

UNIT PACKAGE: 1 Kit

Not Actual Size



21408

Greaseable Stainless Steel
Door Hinge Pin & Nut Repair Kit

Repairs Two Hinges

Jeep Wrangler (YJ)
With Half Steel Doors
1995 - 1988

Jeep Wrangler (TJ)
2006 - 1997

Jeep Wrangler Unlimited (TJ)
2006 - 2004

UNIT PACKAGE: 1

Not Actual Size



21407

Greaseable Stainless Steel
Tailgate Hinge Pin & Nut Repair Kit

Repairs Two Hinges

Jeep Wrangler (YJ)
With Half Steel Doors
1995 - 1988

Jeep Wrangler (TJ)
2006 - 1997

Jeep Wrangler Unlimited (TJ)
2006 - 2004

UNIT PACKAGE: 1



14561

(6500361)
Zinc

Door Hinge Pin
Length: 2-1/4"
Pin Dia: 1/4"
Chrysler
1980-On

UNIT PACKAGE: 10

AMC CLIPS & FASTENERS

Sec. 20



11470
(AMC: SF 400 6204;
GM: 1606642,
1618890)

1/4"-28 x 1-7/8"
Headlight Adjusting Screw & Nut
AMC & Cadillac
1975-On

UNIT PACKAGE: 25



13036
Black

Window Crank
Handle Knob
AMC

UNIT PACKAGE: 2

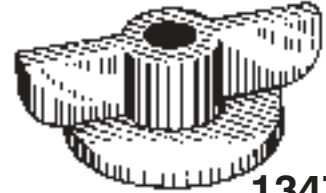

13472
(Ford: 386285,
AMC: 3230375)
Nylon

Air Cleaner Wing Nut
Self Threading
1/4", 6mm
Ford and AMC

UNIT PACKAGE: 10



Right-Hand Side Left-Hand Side

10262
Nylon

Door Lock Rod & Hood
Latch Locking Push Rod Clip
Rod Size: 5/32"
Fits Into 1/4" Hole
Chrysler, Ford, GM & AMC

UNIT PACKAGE: 20 Pieces
10 Rights - 10 Lefts

20675

(AMC: 4003672R;
Chry: 2945108R, 4658676;
GM: 16627328;
Ford: N805350S)
White Nylon

Clip For Right-Hand Side Only

UNIT PACKAGE: 25

14967

(AMC: 4003673L;
Chry: 2945109L, 4658677;
GM: 9815325, 16607593;
Ford: D2VZ-6521952A, N804344S)
Black Nylon

Clip For Left-Hand Side Only

UNIT PACKAGE: 50



11697
(4000141)
Nylon

#6 or #8 Screw Size
AMC

UNIT PACKAGE: 50



2272
(3426388)

Front Fender and Door
Quarter Panel Moulding
Fastener:
Rambler

UNIT PACKAGE: 100



15813
(4005714)
Nylon

Window Glass Retainer
AMC Eagle
1988-On

UNIT PACKAGE: 25



15666

(AMC: 36000148,
36001966, 56001419;
VW: 176 941 1117A)

1/4"-28 x 2-1/4"
Headlight Adjusting Screw
and Nut Assembly
AMC Encore &
Alliance 1983-On
VW

UNIT PACKAGE: 10



14217

(GM: 1257702,
20346654;
Ford: 383207-S;
AMC: 3693099)
Nylon

Routing Clip
GM / Ford / AMC

UNIT PACKAGE: 25



Groove
61
Y-152

19952
(Strat: 320514)
1984-70
U.P. 25



Groove
53
Y-149

19947
(Strat: 320433)
1990-70
U.P. 25



Groove
60
RA4

19970
(Strat: 321074)
Ram Charger
1990-81
U.P. 5

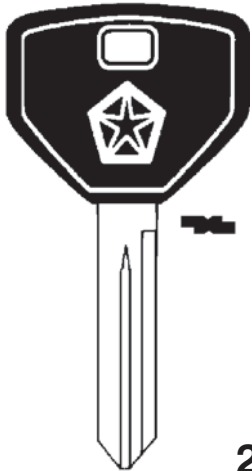

Groove
73
Y-154

20030
(Strat: 594145)
1992-89
U.P. 10



Groove
78
Y-155

20035
(Strat: 595895)
1993
U.P. 10



Groove
84
Y-157

20110
(Strat: 596504)
Chrysler
1996-94
U. P. 10



Groove
84

21100
(Strat: 5909874)
Transponder
For Anti-Theft
Security
Chrysler 300, Town & Country,
Caravan, Charger,
Magnum, Jeep Commander
& Cherokee
2008 - On

UNIT PACKAGE: 1



Groove
84
10 Cut

20155
(Chrys: 5013809-AA
Strat: 599013)

Chrysler Key Blank
One Key System
Jeep Grand Cherokee
1999 - On

UNIT PACKAGE: 10



Groove 84

20152
(Strat: 596508;
Chry: 4746316)

Jeep Cherokee
1997

UNIT PACKAGE: 10



Groove 84
8 Cut

19791
(Strat: 598495;
Chry: 5010366AA)

Internal
Transponder
For Anti-Theft
Security
One Key System
Cirrus, Concorde,
New Yorker, Intrepid,
Sebring & Vision
1999 - On

UNIT PACKAGE: 1



Groove 84

20861
(Strat: 692352;
Chry: 5134937-AA
5102247-AA)

Transponder
For Anti-Theft Security
One Key System
Caravan, Durango, Grand
Cherokee, Liberty, Pacifica
And Town & Country
2004 - On

UNIT PACKAGE: 1



Groove 84

Y-159

20139
(Strat: 597121)

Primary Key Blank
Chrysler Mini-Van
1996-On

UNIT PACKAGE: 10



Groove 85
Code Series L
Y-158

20090
(Strat: 322235,
322236)

Ignition & Door
Valet Key Blank
Chrysler 1996-94

UNIT PACKAGE: 10

Chrysler Key Blank Chart	
Groove	Application
61 53	1990-69
60	Ram Charger
73	1992-1989
78 79	1993

Larger Quantities Available

**Remember...
All Items In This Catalog Are Available In Bulk.**

Call For A Quote.

FORD KEY BLANKS



Groove 40

19930
(Strat: 32838)

1964-52

UNIT PACKAGE: 10



Groove 49
H51

19973
(Strat: 321207)

1988-65

UNIT PACKAGE: 25



Groove 48
H50

19972
(Strat: 321202)

1988-65

UNIT PACKAGE: 25



8 Cut
Groove 82
H75F

20122
(Strat: 597638)

Primary & Secondary
Key Blank
Taurus & Explorer
1996
F-Series, Bronco
& Ranger 1997 - On

UNIT PACKAGE: 10



10 Cut
H60
H67

20092
(Strat: 596758)

Ignition
Key Blank
Ford 1995-93

U.P. 10



Groove 49

10 Cut
H55

19985
(Strat: 321648)

1984-On

U.P. 15



Groove 82
H75P

20123
(Strat: 597037)

Primary & Secondary
Key Blank
Mercury Sable
1996

UNIT PACKAGE: 10



Code:
1X-1706X

19926
(ILCO: H72PT)

Security System
Key Blank
Internal Transponder
Ford Crown Victoria,
Excursion,
Expedition, Explorer,
F-Series Pick Up,
Mustang, Ranger &
Taurus
2000 - 98

UNIT PACKAGE: 1



Groove 82

21043
(Strat: 693224)

F-Series Super Duty
Truck
2008

UNIT PACKAGE: 5





GENERAL MOTORS KEY BLANKS



Sec. 21

GM KEY BLANK CHART					
Groove	Years Of Application				
50-A	67	71	75	79	86-83
51-B					
54-C	68	72	76	80	90-87
55-D					
56-E	69	73	77	81	91-On
57-H					
58-J	70	74	78	82	
59-k					

Larger Quantities Available

 <p>Grv. 56-E H98E B-44</p> <p>19944 (Strat: 320404) U.P. 25</p>	 <p>Grv. 57-H H98H B-45</p> <p>19945 (Strat: 320405) U.P. 25</p>	 <p>Grv. 54-C H98C B-50</p> <p>19957 (Strat: 320652) U.P. 25</p>	 <p>Grv. 55-D H98D B-51</p> <p>19958 (Strat: 320653) U.P. 25</p>
--	---	--	--

 <p>Grv. 50-A H98A B-48</p> <p>19954 (Strat: 320588) U.P. 25</p>	 <p>Grv. 51-B H98B B-49</p> <p>19955 (Strat: 320589) U.P. 25</p>	 <p>Grv. 15 B10</p> <p>19928 (Strat: 32318) 1966-36 U.P. 10</p>	 <p>Grv. 15 B11</p> <p>19929 (Strat: 32319) 1966-36 U.P. 10</p>
---	---	---	--

 <p>Grv. 55-D B67</p> <p>19982 (Strat: 321622) "W" Bodies 1990-88 U.P. 10</p>	 <p>Grv. 57-H B-79</p> <p>20008 (Strat: 321951) "W" Bodies 1991-On U.P. 15</p>
---	---

Visit The Auveco Web Site At www.auveco.com For The Latest Information On New Items.

GENERAL MOTORS KEY BLANKS (Cont.)



B-68

20010

(Strat: 322046)
Double Side

U.P. 10

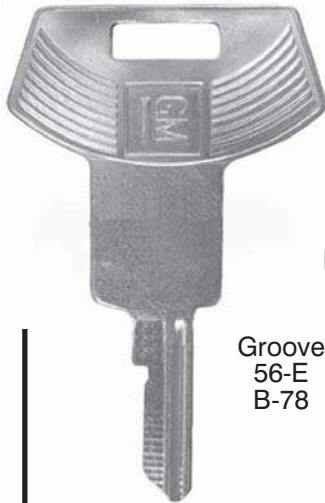

Groove
56-E
B-78

20011

(Strat: 322050)

U.P. 10



Groove
75
B85

20108

(Strat: 322177)
Secondary
Key Blank
Achieva, Grand Am
& Skylark
1995-94

U.P. 10

GM KEY BLANK CHART					
Groove	Years Of Application				
50-A	67	71	75	79	86-83
51-B					
54-C	68	72	76	80	90-87
55-D					
56-E	69	73	77	81	91-On
57-H					
58-J	70	74	78	82	
59-K					

**LARGER
QUANTITIES
AVAILABLE**

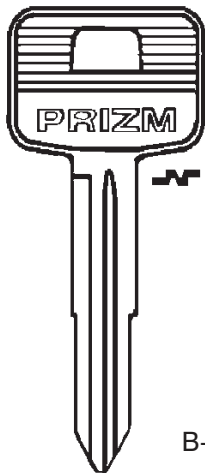

B-72

20007

(Strat: 321909)

Geo Prizm
GP Series

U.P. 10



B-70

20012

(Strat: 322079)

Geo Storm
GST Series

U.P. 10



Display Boards Are Great Selling Tools. Use Them To Help Boost Your Sales. Refer To The Color Pages At The Front Of The Catalog.

GENERAL MOTORS KEY BLANKS (Cont.)

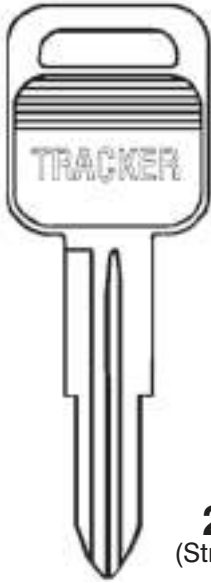

Grv.
GTA
B-69

20109
(Strat: 321846)

Geo Tracker
1995-89

UNIT PACKAGE: 10



Groove
56-E

20033
(Strat: 595311)

UNIT PACKAGE: 10



Groove
57-H

20032
(Strat: 595198)

UNIT PACKAGE: 10



Groove
56-E
B-77

20034
(Strat: 595313)

Beretta & Corsica
1991-On

UNIT PACKAGE: 10



Groove
75
10 Cut
B-82
B-86

20088
(Strat: 595936,
597500)

Ignition Key Blank
Cavalier & Sunbird 1995
Achieva
Grand Am &
Skylark 1995-94

UNIT PACKAGE: 10



Groove 75
B89

20149
(Strat: 597749;
GM: 26053314)

Primary Key
GM Achieva, Cavalier,
Grand Am, Skylark &
Sunfire
1997-96

UNIT PACKAGE: 10



Groove 88

20151
(Strat: 597253;
GM: 26049794)

Pontiac
Grand Prix
1997

UNIT PACKAGE: 10

GENERAL MOTORS KEY BLANKS (Cont.)



Groove
75
10 Cut
B83

20089
(Strat: 596222)

Ignition & Door
Key Blank
Blazer,
Suburban,
Sonoma
S-10 & Vans
1996-95

UNIT PACKAGE: 10



Groove 75
PK3

21193
(Strat: 5912114;
GM: 19207416)

Transponder Key
For Anti-Theft Security
Cadillac CTS & STS
2007 - 03

UNIT PACKAGE: 1



Groove 93

21045
(Strat: 5904001;
GM: 25847343)

Transponder Key
For Anti-Theft Security
One Key System
Cadillac DTS, Escalade,
ESV, EXT & STS
2004 - On

UNIT PACKAGE: 1



Groove 75
B91P

20146
(Strat: 597791;
GM: 2852058)

One Key System
Chevrolet Malibu
1997

UNIT PACKAGE: 10



Groove 93

20945
(Strat: 692931;
GM: 89024363,
15824471)

Transponder
For Anti-Theft
Security
Chevrolet Impala
2006 - On

UNIT PACKAGE: 1



21167
(Strat: 5912554,
GM: 96585564)

Transponder Key
For Anti-Theft Security
Chevrolet Aveo
2008 - On

UNIT PACKAGE: 1



21168
(Strat: 691222
GM: 89023920)

Groove 93
One Key System
Chevrolet Cobalt
2005-On

UNIT PACKAGE: 5

GENERAL MOTORS KEY BLANKS (Cont.)



Groove 75
B91P

20147
(Strat: 597796;
GM: 2852063)
One Key System
Olds Cutlass
1997

UNIT PACKAGE: 10



Code Series:
R, T, S.

20324
(ILCO: B96-P)

One Key System
Saturn
2001 - 97

UNIT PACKAGE: 5



Groove 75
10 Cut

20156
(GM: 2852065;
Strat: 597798)

One Key System
Grand AM
1999-On

UNIT PACKAGE: 10



Groove 75
10 Cut

20157
(GM: 15026223;
Strat: 598007)
One Key System
Astro Van, Full Size
Pick-Up, S10 & Blazer
1999-On

UNIT PACKAGE: 10



Groove 75
10 Cut

20158
(GM: 15026222;
Strat: 598009)
One Key System
Jimmy, Safari Van, Sonoma
P/U, Vandura Full Size Van
1999-On

UNIT PACKAGE: 10

GM KEY BLANK CHART					
Groove	Years Of Application				
50-A	67	71	75	79	86-83
51-B					
54-C	68	72	76	80	90-87
55-D					
56-E	69	73	77	81	91-On
57-H					
58-J	70	74	78	82	
59-K					

GENERAL MOTORS KEY BLANKS (Continued)

GM VATS KEY BLANKS

Single Sided Primary Vats

Groove 50 A

1995 Key Codes:

- Primary AA00-7N45 Modular
- Primary 00J0-99J9, Secondary 00L0-99L9
- Primary 00K0-99K9, Secondary 00M0-99L9



Auveco Part No.	Resistor Value	B & S No.	Application	Unit Pkg.
20094	2	595512, 594202	Buick: LeSabre, Park Ave. & Regal	1
20097	5	595515, 594205	Cadillac: Concours, Deville, Eldorado, Fleetwood & Seville	1
20101	9	595519, 594209	Chevrolet: Camaro, Corvette & Lumina Oldsmobile: Cutlass Ciera, Cutlass Supreme, 88 Royale & 98 Touring Sedan Pontiac: Bonneville, Firebird & Grand Prix	1

20093

(Strat: 321631)

Vats Work Key

Groove 50A

U.P. 5

Important: Resistor value of replacement key must match resistor value of original key.

GM VATS KEY BLANK
Double Sided Primary Vats
Groove 75

1996-95 Key Codes:

- Primary AA00-7N45 Modular
- Primary 00J0-99J9, Secondary 00L0-99L9
- Primary 00K0-99K9, Secondary 00M0-99L9

Auveco Part No.	Resistor Value	B & S No.	Unit Application	Unit Pkg.
20131	9	596779	Buick Riviera & Oldsmobile Aurora	1



Groove 75

Important: Resistor value of replacement key must match resistor value of original key

HEAVY DUTY TRUCKS



Groove 85
Codes: FL001-262
19844
(Strat.: 597893;
Frtln: 22-44567-000)
Primary Key Blank
Freightliner Century
1994 - On
UNIT PACKAGE: 10



19966
(Strat: 320734)
Kenworth
UNIT PACKAGE: 10



19976
(Strat: 321490)
Navistar
UNIT PACKAGE: 10

IMPORT KEY BLANKS



21079
(Strat: 5907552;
Acura: 35113-SEC-A01)
Transponder Key Blank
With Black Plastic Head
"V" Key
Acura TL & TSX
2004 - On
UNIT PACKAGE: 1



Groove 75
20150
(Strat: 597457;
Isuzu: 26048001)
Isuzu Hombre
UNIT PACKAGE: 10



Code Series:
10100-12283
20313
(ILCO: X222 MZ27)
One Key
System
Mazda 626,
Protege
& MPV Van
1997 - 93
UNIT PACKAGE: 10

IMPORT KEY BLANKS (Cont.)



Code Series:
E5001 -
7679

20325

(ILCO: MIT4X245)

One Key System
Mitsubishi Diamante,
Galant & Montero
2000 - 97

UNIT PACKAGE: 10



21073

(Strat:
5907793;
Mitsubishi:
MR587315)

Transponder Key Blank
With Black Plastic Head
Mitsubishi Diamante
& Montero 2006 - 01
and Montero Sport
2004 - 01

UNIT PACKAGE: 1



DA25

19994

(Strat: 321727)

Nissan
NA Series

UNIT PACKAGE: 10



21042

(Strat: 7003526;
Nissan: H0564-7Y000,
H0564-7Y010)

Transponder Key
For Anti-Theft Security
Key Number N104T
Infiniti FX35/45,
G35 & QX56;
Nissan Armada, Maxima
& 350Z
2003 - On

UNIT PACKAGE: 1



Groove 98

21101

(Strat: 5910834;
Toyota: 89785-08020,
89785-60160,
89785-34020)

Transponder
For Anti-Theft Security
Toyota Avalon, Camry, Corolla, FJ Cruiser,
Highlander, Land Cruiser, Matrix, RAV4,
Scion tC, Sequoia, Sienna, Solara,
Tacoma, Tundra & Yaris
2003 - On

UNIT PACKAGE: 1



Code Series:
10001-15000

19812

(ILCO: TR47-P)

One Key System
Toyota Avalon,
Camry, Celica,
Corolla, RAV4,
Sienna, Solara,
Tacoma & Tundra
1992 - On

UNIT PACKAGE: 5



Code
Series:
AH1-9282

20394

(ILCO: V35-P)

One Key System
VW Cabrio, Corrado,
Golf & Jetta 1999 - 88
Passat 1997 - 90
Eurovan 2000 - 99

UNIT PACKAGE: 5

TUMBLERS, SPRINGS & RETAINERS

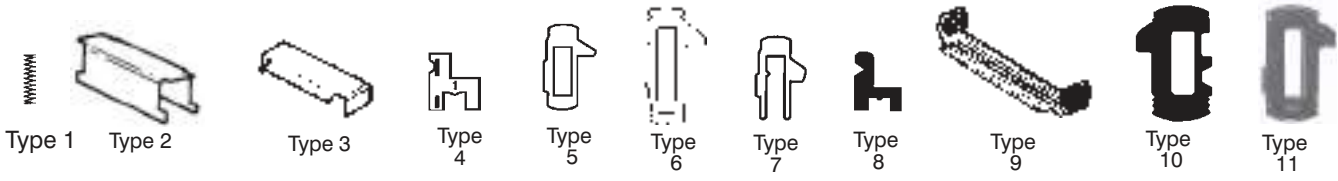

Auveco Part No.	Strattec No.	Illus. Type	Description	Unit Pkg.
19932	46648	1	GM, Chrysler & AMC Tumbler Spring, 7/16" Long, 5/64" O.D.	100
19933	46890	1	Chrysler Double Bitted Tumbler Spring, 17/64" Long, 1/16" O.D.	100
20115	56028	1	GM Tumbler Spring, 10 Cut, Sidebar Ignition, 5/16" Long, 5/64" O.D.	25
19936	320126	2	Ford Tumbler Retainer, 7/32" Wide, 3/4" Long	10
19971	321127	3	GM Side Bar Tumbler Retainer, 7/32" Wide, 5/8" Long	100
19939	320292	4	GM & Jeep Side Bar Tumbler #2, .025 Depth Charge	50
19940	320293	4	GM & Jeep Side Bar Tumbler #3, .025 Depth Charge	50
19941	320294	4	GM & Jeep Side Bar Tumbler #4, .025 Depth Charge	50
19942	320295	4	GM & Jeep Side Bar Tumbler #5, .025 Depth Charge	50
19961	320668	5	GM & H.D. Truck Snap-In Tumbler #4, .025 Depth Charge	100
19962	320669	5	GM & H.D. Truck Snap-In Tumbler #5, .025 Depth Charge	100
19996	321762	6	Chrysler, Jeep & GM Saturn Double Bitted Tumbler #2	50
19997	321763	6	Chrysler, Jeep & GM Saturn Double Bitted Tumbler #3	50
19964	320698	7	GM & H.D. Truck Retainer Tumbler (Standard), .025 Depth Charge	50
20111	322521	8	GM Sidebar Ignition Tumbler, #1 Depth, 10 Cut	25
20112	322522	8	GM Sidebar Ignition Tumbler, #2 Depth, 10 Cut	25
20113	322523	8	GM Sidebar Ignition Tumbler, #3 Depth, 10 Cut	25
20114	322524	8	GM Sidebar Ignition Tumbler, #4 Depth, 10 Cut	25
20116	322117	9	GM Tumbler Retainer, 10 Cut, Sidebar Ignition	15
20118	322242	10	GM Door & Deck Lock Cylinder Tumbler, #2 Depth, 10 Cut	25
20120	322244	10	GM Door & Deck Lock Cylinder Tumbler, #4 Depth, 10 Cut	25
20143	322363	11	Chrys./Jeep Wide Body Tumbler, #3 Depth, Double Bitted	25

Sec. 21



Type 1



Type 2



Type 3



Type 4



Type 5

HARDWARE & ACCESSORIES

Auveco Part No.	Strattec No.	Description	Unit Pkg.
19931	46399	1.....GM Lock Cylinder Return Spring, 5/8" Coil I.D., 11/16" Coil O.D.	25
19975	321480	2.....Universal Lock Cylinder Retainer Clip	10
19977	321963	3.....GM Pawl Retainer Clip	10
20015	380055	4.....GM Rectangular Key Boot (Black)	25
20016	380060	5.....GM Oval Key Boot (Black)	25

LOCKS

GENERAL MOTORS

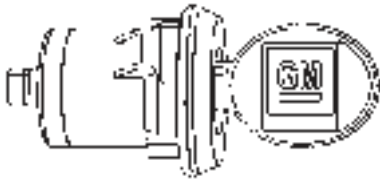

20047

(Strat: 608170)

Door, Deck & Tailgate Lock
Coded, Chrome Cap
Short (7/32") Shaft Length
GM 1977-On

UNIT PACKAGE: 1

GENERAL MOTORS (Cont.)



20068

(Strat: 700744)

Tailgate Lock
Coded, Chrome Cap
Century, Celebrity, Cutlass
Ciera & 6000 Wagon
(A Body) 1983-On

UNIT PACKAGE: 1



20038

(Strat: 605533)

Deck & Tailgate Lock
Coded, Chrome Cap
Vertical Clip
GM 1977-On

UNIT PACKAGE: 1

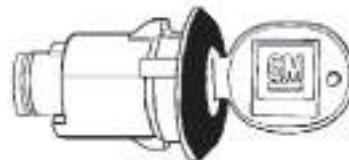

20069

(Strat: 700745)

Tailgate Lock
Coded, Black Chrome Cap
Century, Celebrity, Cutlass
Ciera & 6000 Wagon
(A Body) 1983-On

UNIT PACKAGE: 1

LOCK SETS & LOCK SERVICE PACKAGES

LOCK SET GENERAL MOTORS



20055
(Strat: 608441)

Ignition & Door Locks
Coded, Chrome Caps
Dash Mounted Ignition
Short (7/32") Shaft Length
On Door Locks
GM 1966-On

UNIT PACKAGE: 1 Set

LOCK SERVICE PACKAGES
CHRYSLER & JEEP

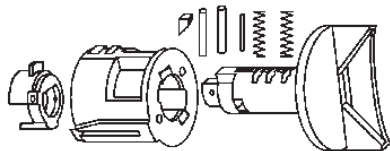

20078
(Strat: 701247)

Ignition Lock (Push To Start)
Chrome Cylinder
Chrysler 1992-90

UNIT PACKAGE: 1

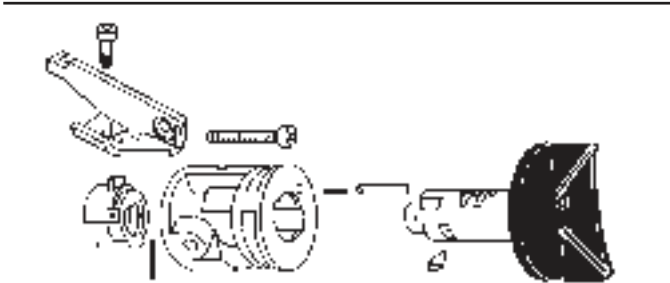

20138
(Strat: 702788)

Ignition Lock
Service Package
Chrysler LeBaron, Town & Country,
Caravan, Voyager, Spirit, Ram Van,
Ram Charger & Dakota 1995
& Jeep Cherokee 1996

UNIT PACKAGE: 1

LOCK SERVICE PACKAGES
GENERAL MOTORS

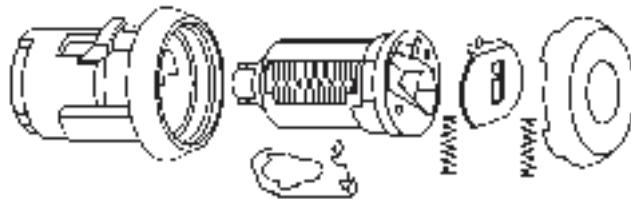

20040
(Strat: 607868)

Door, Deck & Tailgate Lock
Chrome Cap
Short (7/32") Shaft Length
GM 1977-On

UNIT PACKAGE: 1

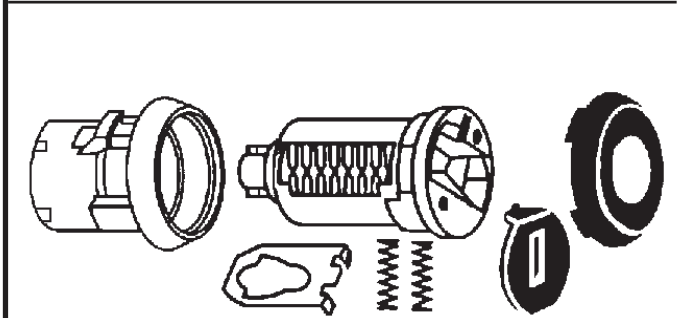

20073
(Strat: 700839)

Door Lock
Black Chrome Cap
Mini-Van & APV
Front Door 1984-On

UNIT PACKAGE: 1

Key Manufacturer Number To Auveco Cross Reference

Mfg. No.	Auveco No.	Page No.	Mfg. No.	Auveco No.	Page No.	Mfg. No.	Auveco No.	Page No.
Strattec			Strattec (Cont'd)			Strattec (Cont'd)		
32318.....	19928.....	555	322177.....	20108.....	556	599013.....	20155.....	552
32319.....	19929.....	555	322235.....	20090.....	553	605533.....	20038.....	564
32838.....	19930.....	554	322236.....	20090.....	553	607868.....	20040.....	565
46399.....	19931.....	564	322242.....	20118.....	563	608170.....	20047.....	564
46648.....	19932.....	563	322244.....	20120.....	563	608441.....	20055.....	564
46890.....	19933.....	563	322363.....	20143.....	563	691222.....	21168.....	558
56028.....	20115.....	563	322521.....	20111.....	563	692352.....	20861.....	553
320126.....	19936.....	563	322522.....	20112.....	563	692931.....	20945.....	558
320292.....	19939.....	563	322523.....	20113.....	563	693224.....	21043.....	554
320293.....	19940.....	563	322524.....	20114.....	563	700744.....	20068.....	564
320294.....	19941.....	563	380055.....	20015.....	564	700745.....	20069.....	564
320295.....	19942.....	563	380060.....	20016.....	564	700839.....	20073.....	565
320404.....	19944.....	555	590874.....	21100.....	552	701247.....	20078.....	565
320405.....	19945.....	555	594145.....	20030.....	552	702788.....	20138.....	565
320433.....	19947.....	552	594202.....	20094.....	560	5904001.....	21045.....	558
320514.....	19952.....	552	594205.....	20097.....	560	5907552.....	21079.....	561
320588.....	19954.....	555	594209.....	20101.....	560	5907793.....	21073.....	562
320589.....	19955.....	555	595198.....	20032.....	557	5909874.....	21100.....	552
320652.....	19957.....	555	595311.....	20033.....	557	5910834.....	21101.....	562
320653.....	19958.....	555	595313.....	20034.....	557	5912114.....	21193.....	558
320668.....	19961.....	563	595512.....	20094.....	560	5912554.....	21167.....	558
320669.....	19962.....	563	595515.....	20097.....	560	7003526.....	21042.....	562
320698.....	19964.....	563	595519.....	20101.....	560			
320734.....	19966.....	561	595895.....	20035.....	552			
321074.....	19970.....	552	595936.....	20088.....	557			
321127.....	19971.....	563	596222.....	20089.....	558			
321202.....	19972.....	554	596504.....	20110.....	552			
321207.....	19973.....	554	596508.....	20152.....	553			
321480.....	19975.....	564	596758.....	20092.....	554			
321490.....	19976.....	561	596779.....	20131.....	560			
321622.....	19982.....	555	597037.....	20123.....	554			
321631.....	20093.....	560	597121.....	20139.....	553			
321648.....	19985.....	554	597253.....	20151.....	557			
321727.....	19994.....	562	597457.....	20150.....	561			
321762.....	19996.....	563	597500.....	20088.....	557			
321763.....	19997.....	563	597638.....	20122.....	554			
321846.....	20109.....	557	597749.....	20149.....	557			
321909.....	20007.....	556	597791.....	20146.....	558			
321951.....	20008.....	555	597796.....	20147.....	559			
321963.....	19977.....	564	597798.....	20156.....	559			
322046.....	20010.....	556	597893.....	19844.....	561			
322050.....	20011.....	556	598007.....	20157.....	559			
322079.....	20012.....	556	598009.....	20158.....	559			
322117.....	20116.....	563	598495.....	19791.....	553			
						ILCO		
						B96P.....	20324.....	559
						H72PT.....	19926.....	554
						MIT4X245.....	20325.....	562
						TR47-P.....	19812.....	562
						V35-P.....	20394.....	562
						X222 MZ27.....	20313.....	561



17440

(91501-SG0-003)
Nylon

Body Side Moulding Clip
Legend
1987-On

UNIT PACKAGE: 15



21557

(75316-S9A-004)
White Nylon

Door Trim
Moulding Clip
Head Size: 14mm x 16mm
Stem Length: 12mm
Fits Into 10mm Hole
Acura RDX and Honda CR-V
2002 - On

UNIT PACKAGE: 25



21639

(72431-S2X-003)
White Nylon

Moulding Clip
Top Head Size: 8mm x 10.5mm
Bottom Head Size: 11mm x 16mm
Overall Height: 14.6mm
Acura RSX and Honda Civic,
CR-Z & Insight
2006 - 01

UNIT PACKAGE: 25



21559

(91512-SJ6-J01)
Black Nylon

Rocker Panel, Tail Light &
License Plate Housing
Garnish Moulding Clip
With Sealer
Top Head Size: 9mm x 12mm
Bottom Head Diameter: 13mm
Stem Diameter: 7.5mm
Stem Length: 9mm
Acura TSX and
Honda Civic & CR-V
1997 - On

UNIT PACKAGE: 25



21308

(90602-SFA-004)
White Nylon

Cowl & Dash
Moulding Clip
Top Head Size: 13mm x 14mm
Bottom Head Diameter: 16mm
Stem Length: 13mm
Acura RL and Honda Civic,
Civic Hybrid & Odyssey
2005 - On

UNIT PACKAGE: 25



19225

(91501-SP1-003)
Nylon

Side Sill
Garnish Moulding Clip
Legend Coupe
1991-On

UNIT PACKAGE: 10



21555

(91512-S50-003)
White Nylon

License Plate Garnish &
Trim Moulding Clip
With Sealer
Top Head Size: 12mm x 17mm
Bottom Head Size: 16mm x 17mm
Stem Diameter: 13mm
Stem Length: 12mm
Acura TSX & ZDX and
Honda Accord,
Civic, Crosstour, Fit, Insight,
Odyssey & Pilot
2001 - On

UNIT PACKAGE: 25



21558

(91504-SP1-003)
White Nylon

Rocker Panel & Fender
Moulding Clip
With Sealer
Top Head Size: 16mm x 18mm
Bottom Head Size: 18mm x 20mm
Stem Length: 15mm
Fits Into 10mm Hole
Acura Legend, MDX, RL & ZDX
and Honda Civic, CR-V & Odyssey
1991 - On

UNIT PACKAGE: 25



21204

(75315-STK-A01)
White Nylon

Front & Rear Door
Exterior Trim
Moulding Clip
Top Head Size: 12mm x 15mm
Bottom Head Size: 14mm x 20mm
Stem Length: 9mm
RDX
2009 - 07

UNIT PACKAGE: 15



19740

(90666-SSO-003)
White Nylon

Roof Moulding Clip
Acura Integra & Legend
Honda Prelude
1992-On

UNIT PACKAGE: 10



18756

(90621-SK7-003)
White Nylon

Windshield Corner Moulding Clip
Integra
1993-90

UNIT PACKAGE: 5



18759

(90601-SK7-003)
Green Nylon

Windshield Side Moulding Clip
Integra 3 & 4 Door
1993-90

UNIT PACKAGE: 15



17323

(91513-SP0-003)
Teal Nylon

Windshield Side Moulding Clip
4 Door Legend
1991-On

UNIT PACKAGE: 10



18761

(91536-SP0-003)
Light Blue Nylon

Windshield Corner Moulding Clip
Legend 4 Door
1991-On

UNIT PACKAGE: 5



18764

(91514-SP0-003)
Yellow Nylon

Windshield Side Moulding Clip
Legend 4 Door
1991-On

UNIT PACKAGE: 5



17280

(91505-SG0-003)
Orange Nylon

Windshield Moulding Clip
Honda Prelude and
Acura Legend
1988-On

UNIT PACKAGE: 10



18763

(90611-SK7-003)
White Nylon

Windshield Corner Moulding Clip
Integra
1993-90

UNIT PACKAGE: 5

18757

(91527-SP1-003)
Green Nylon



Windshield Side Moulding Clip
Legend 2 Door
1991-On

UNIT PACKAGE: 5



17282

(91534-SM4-003)
White Nylon

Windshield Moulding Clip
Honda Accord 1990-On
Acura Legend 1991-On

UNIT PACKAGE: 10



19668

(91533-ST0-003)
Yellow Nylon

Windshield Moulding Clip
Integra
1994-On

UNIT PACKAGE: 10

ACURA CLIPS & FASTENERS



18765
(90612-SK7-003)
White Nylon

Windshield Side Moulding Clip
Integra
1993-90

UNIT PACKAGE: 10



19478
(91574-SV2-003)
Yellow Nylon

Windshield Moulding Clip
Acura 2.2CL, 2.3CL & 3.0CL
and Honda Accord
1994 - On

UNIT PACKAGE: 15



18760
(91514-SP1-003)
Red Nylon

Windshield Side Moulding Clip
Legend 2 Door
1991-On

UNIT PACKAGE: 5



18754
(91535-SP0-003)
Green Nylon

Windshield Corner Moulding Clip
Legend 4 Door
1991-On

UNIT PACKAGE: 5



18768
(91526-SP0-003)
White Nylon

Windshield Side Moulding Clip
Legend 4 Door
1991-On

UNIT PACKAGE: 5



18767
(91526-SP1-003)
Blue Nylon

Windshield Side Moulding Clip
Legend 2 Door
1991-On

UNIT PACKAGE: 5



19476
(91577-SV4-003)
Red Nylon

Windshield Left-Hand Corner
Moulding Clip
Acura 2.2CL, 2.3CL & 3.0CL
and Honda Accord & Odyssey
1994 - On

UNIT PACKAGE: 10

18758
(91528-SP1-003)
Yellow Nylon

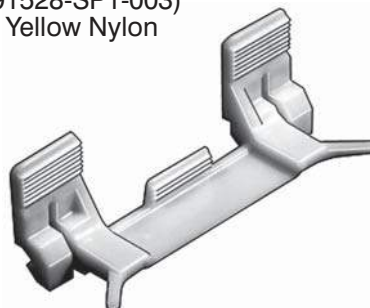

Windshield Side Moulding Clip
Legend 2 Door
1991-On

UNIT PACKAGE: 5



19477
(91576-SV4-003)
Green Nylon

Windshield Right-Hand Corner
Moulding Clip
Acura 2.2CL, 2.3CL & 3.0CL
and Honda Accord & Odyssey
1994 - On

UNIT PACKAGE: 10

Please Order In Unit
Package Quantities
Not Number Of
Pieces



18762

(91512-SP1-000)
Black Nylon

Windshield Upper Moulding Clip
Legend 2 Door
1991-On

UNIT PACKAGE: 5



21543

(91570-SZA-305)
Blue Nylon

Windshield Moulding Clip
Width: 8mm
Length: 82mm
Acura ZDX and
Honda Odyssey & Pilot
2009 - On

UNIT PACKAGE: 5



19734

(90107-SX0-003)
Black Nylon

Bumper Grommet
#10 Screw Size
Head Size: 16mm x 18mm
Stem Length: 6mm
Acura 2.2CL, 2.3CL,
2.5TL, 3.2TL, 3.5RL
Honda Accord & Prelude
1996-On

UNIT PACKAGE: 15



18456

(90661-ST7-003)
Nylon

Bumper Clip
Integra
1994-On

UNIT PACKAGE: 5



17268

(90676-SD2-003)
White Nylon

Quarter Window
Moulding Clip
Integra
1985-On

UNIT PACKAGE: 15



21521

(90107-S0X-A01)
Black Nylon

Screw Grommet
M4.8 (#10) Screw Size
Head Size: 16mm x 16mm
Stem Length: 7mm
Acura CL, MDX, RL, 3.2 CL
& 3.5RI and Honda Accord,
Pilot, Ridgeline & S2000
1996 - On

UNIT PACKAGE: 25



17608

(91568-SL4-003)
Black Nylon

Windshield Side Moulding Clip
Vigor
1992-On

UNIT PACKAGE: 15



18236

(91537-SP0-013)
White Nylon

Windshield Clip
Legend
1991-On

UNIT PACKAGE: 10



19679

(91641-SH3-013)
Yellow Nylon
w/ Steel Insert

Garnish Moulding Grommet
Head Diameter: 14mm x 26mm
Acura Integra, Honda Civic
& Prelude
1988 - On

UNIT PACKAGE: 10



19479

(91561-SW5-003)
White Nylon

Windshield Moulding Clip
TL 2.5 & 3.2
1996 - On

UNIT PACKAGE: 15

Visit The Auveco
Web Site At
www.auveco.com For
The Latest Information
On New Items.



19465

(91652-SPO-003)
Natural Nylon

Center Pillar Garnish
Screw Grommet
#4 Screw Size
3.5 RL
1996 - On

UNIT PACKAGE: 15



19463
(91651-SZ3-003)
Natural Nylon

Inner Front Door Lining
Sash Garnish Grommet
3.5RL
1996 - On

UNIT PACKAGE: 10



19723
(91503-SK7-013)
Saddle Tan Nylon

Center Pillar Moulding
Screw Grommet
#4 Screw Size
Head Size: 10mm x 14mm
Stem Length: 10mm
Integra
1994 - On

UNIT PACKAGE: 15



20954
(90682-SEA-003)
Black Nylon

Fender Apron Grommet
#8 (M4.2) Screw Size
Head Diameter: 20mm
Stem Length: 12mm
Fits Into 9mm Square Hole
Acura TSX and
Honda Civic & Odyssey
2004 - On

UNIT PACKAGE: 25



21209
(91601-STX-A00)
Gray Nylon

Rear Hatch
Screw Grommet
With Sealer
M3.5 (#6) Screw Size
Top Head Diameter: 12mm
Bottom Head Diameter: 14mm
Stem Length: 10mm
MDX
2009 - On

UNIT PACKAGE: 10



20472
(91512-SR3-004)
White Nylon

Tubular Nut
With Sealer & Sealed End
3mm Stud Size
Head Dia: 8.5mm
Fits Into 6mm Hole
Emblem Nut
Acura Integra and
Honda Accord, Civic,
CR-V & Prelude
1994 - On

UNIT PACKAGE: 10



18877
(91530-SP1-003)
Orange Nylon

Weatherstrip Retainer
Head Size: 5mm x 15mm
Stem Length: 10mm
Fits Into 6mm Hole
Acura 3.5 RL and
Accord, Civic & Odyssey
1992-On

UNIT PACKAGE: 25



18114
(91520-SM4-C010)
Black Nylon

Hood Insulation Retaining Clip
Head Diameter: 10mm
Stem Length: 10mm
Panel Thickness: 4mm
Fits Into 6mm Hole
Honda & Acura 1990-On

UNIT PACKAGE: 25



19506
(90666-SA7-003ZW)
Black Nylon

Trunk Lining Retainer
Head Diameter: 16mm
Stem Diameter: 5mm Square
Stem Length: 16mm
Acura 2.5TL, 3.2TL, 3.5,
Integra & Legend and
Honda Accord Wagon & Prelude
1987 - On

UNIT PACKAGE: 15



19467
(91501-SL4-003)
Black Nylon

Front Cowl Retaining Clip
Head Diameter: 13mm
Stem Diameter: 6mm
Stem Length: 10mm
3.5RL
1996 - On

UNIT PACKAGE: 25



19114
(91518-SM4-003)
Black Nylon

Hood & Trunk Moulding
Retaining Clip
Head Diameter: 12mm
Stem Length: 9mm
Fits Into 6mm Hole
Acura Integra & Honda Civic
1994-On

UNIT PACKAGE: 10



19483
(91515-SR3-000)
Black Nylon

Rear Hood Cowl
Weatherstrip Retaining Clip
Head Size: 8mm x 18mm
Stem Length: 15mm
Fits Into 7mm Hole
Acura Integra, Honda Civic, CR-V
And Del Sol
1992 - On

UNIT PACKAGE: 25



19746
(91652-SZ3-003)
White Nylon

Door Lining Retainer
Head Diameter: 10.5mm
Stem Length: 15mm
3.5RL
1996-On

UNIT PACKAGE: 10



18746
(90700-SJ4-000)
Black Nylon

Hood Insulation Retainer
Head Diameter: 30mm
Stem Diameter: 15mm x 18mm
Stem Length: 10mm
Legend 1991-On
Honda 1998-On
UNIT PACKAGE: 15



21417
(90602-TA0-003)
Blue Nylon

Cowl Vent Retainer
Top Head Size: 10mm x 14mm
Bottom Head Diameter: 16mm
Stem Diameter: 8mm
Stem Length: 13mm
Acura TSX & ZDX and
Honda Accord & Fit
2008 - On
UNIT PACKAGE: 10



20959
(91560-S9A-A01)
Blue Nylon

Door Panel Retainer
Top Head Diameter: 13mm
Middle Head Diameter: 16mm
Bottom Head Diameter: 15mm
Stem Diameter: 9.5mm
Stem Length: 13mm
Acura TL & TSX and
Honda Accord, Civic, CR-V
& Odyssey
2002 - On
UNIT PACKAGE: 25



20609
(91501-S1K-003)
Black Nylon

Hood Insulation Retainer
Head Diameter: 30mm
Stem Diameter: 15mm x 20mm
Stem Length: 14mm
Acura 3.5RL & RSX and
Honda Civic & CR-V
2000 - On
UNIT PACKAGE: 25



19466
(91560-SZ3-003)
White Nylon

Door Trim Panel Retainer
Small Head Diameter: 13mm
Large Head Diameter: 17mm
Stem Diameter: 9.5mm
Stem Length: 12mm
3.5RL 1996 - On
UNIT PACKAGE: 15



21208
(91560-SLJ-J01)
Gray Nylon

Door Trim Panel Retainer
Top Head Diameter: 13mm
Middle Head Diameter: 16mm
Bottom Head Diameter: 18mm
Stem Diameter: 9mm
Stem Length: 12mm
Acura RDX and
Honda Civic, CR-V & Pilot
2009 - On
UNIT PACKAGE: 10



19464
(90667-SD4-003)
Natural Nylon

Roof Lining Retainer
Small Head Diameter: 13mm
Large Head Diameter: 16mm
Stem Diameter: 7mm
Stem Length: 13mm
NSX, 2.2CL & 2.3CL
1991 - On
UNIT PACKAGE: 15



19145
(91560-SP0-003)
Gray Nylon

Front & Rear Door
Trim Panel Retainer
Small Head Dia: 13mm
Large Head Dia: 17mm
Stem Diameter: 9mm
Stem Length: 12mm
Acura Integra & Legend
Honda Accord, Civic,
Prelude, Odyssey & Del Sol
1991-On
UNIT PACKAGE: 25



21107
(90602-SX0-003)
White Nylon

Cowl Vent Retainer
Top Head Diameter: 12mm
Bottom Head Diameter: 16mm
Stem Diameter: 4mm
Stem Length: 13mm
Acura MDX and Honda Civic,
Insight, Odyssey & Prelude
1995 - On
UNIT PACKAGE: 10



20411
(91560-S84-A11)
Black Nylon

Windshield Garnish
Pillar Retainer
Top Head Dia: 13mm
Middle Head Dia: 16mm
Bottom Head Dia: 14.5mm
Stem Diameter: 9.5mm
Stem Length: 12mm
Acura 3.2CL, Honda Accord,
Insight & Odyssey
1998 - On
UNIT PACKAGE: 15



21131
(90602-SEP-A00)
Black Nylon

Trim Panel Retainer
Top Head Diameter: 12mm
Middle Head Diameter: 16mm
Bottom Head Diameter: 18mm
Stem Diameter: 9.5mm
Stem Length: 13mm
TL
2007 - On
UNIT PACKAGE: 15



21059
(90602-S5A-003)
Blue Nylon

Cowl Vent Retainer
Top Head Size: 12mm x 13mm
Middle Head Diameter: 16mm
Bottom Head Diameter: 18mm
Stem Diameter: 8.5mm x 8.5mm
Stem Length: 14mm
Acura RSX and
Honda Civic & CR-V
2001 - On

UNIT PACKAGE: 15



19233
(Acura: 91503-SZ3-003)
Black Nylon

Front Bumper Push-Type Retainer
Head Diameter: 20mm
Stem Length: 13mm
Fits Into 10mm Hole
Acura 3.5 RL Sedan & Honda
1996-On

UNIT PACKAGE: 15



20564
(91503-SZ5-003)
Black Nylon

Front & Rear Bumper
Push-Type Retainer
Head Diameter: 20mm
Stem Length: 18mm
Fits Into 10mm Hole
Acura 3.5RL and Honda Accord
& Odyssey
1996 - On

UNIT PACKAGE: 15



19186
(90657-SB0-003)
Black Nylon

Front Bumper Cover
Push-Type Retainer
Head Diameter: 11mm
Stem Length: 10mm
Fits Into 8mm Hole
Acura Legend, Honda Accord &
Odyssey
1991-On

UNIT PACKAGE: 10



19239
(Honda: 91512-SX0-003;
GM: 11519949; Mitsubishi:
MU000319)
Black Nylon

Front Fender Push-Type Retainer
Head Diameter: 20mm
Stem Length: 11mm
Fits Into 8mm Hole
Acura 3.5RL, Honda Accord,
Prelude & Odyssey 1994-On
GM 1997 - On
Mitsubishi Lancer 2002 - On

UNIT PACKAGE: 25



19140
(Acura: 90505-SL0-003;
GM: 94852368;
Mitsubishi: MB888869;
Toyota: 90467-08155)
Black Nylon

Push-Type Retainer
Head Diameter: 20mm
Stem Length: 21mm
Fits Into 8mm Hole
Acura, Dodge Avenger,
Eagle Talon, Geo Prizm,
Mitsubishi Eclipse & Galant
And Toyota
1993-On

UNIT PACKAGE: 5



19232
(91502-SZ5-003)
Black Nylon

Front Fender
Push-Type Retainer
Head Diameter: 17mm
Stem Length: 13mm
Fits Into 7mm Hole
3.5 RL Sedan
1996-On

UNIT PACKAGE: 10



21173
(91506-S9A-003)
Black Nylon

Bumper & Splash Shield
Push-Type Retainer
With Metal Insert
Head Diameter: 20mm
Stem Length: 16mm
Fits Into 10mm Hole
Acura MDX, RDX, TSX and
Honda Accord, Civic CR-V & Fit
2009 - 04

UNIT PACKAGE: 10



17267
(91503-SP0-003)
Black Nylon

Front & Rear Bumper
Push-Type Retainer
Head Diameter: 20mm
Stem Length: 15mm
Fits Into 10mm Hole
Legend
1991-On

UNIT PACKAGE: 15



19231
(91505-SL0-003)
Black Nylon

Push-Type Retainer
Head Diameter: 18mm
Stem Length: 16mm
Fits Into 8mm Hole
NSX
1991-On

UNIT PACKAGE: 15



21170

(91591-SJ6-013)
Natural Nylon

Door Lock Rod Clip
Rod Size: 5mm
Fits Into 7mm Hole
Overall Height: 17mm
Acura TSX and Honda Accord,
Odyssey & Ridgeline
2003 - On

UNIT PACKAGE: 15



21388

(91558-SE3-003)
Black Nylon

Hood Release Cable,
Fuel Door Release Cable
and Sliding Door Lock
Cable Clip
Maximum Cable Diameter: 5mm
Overall Height In Closed
Position: 17mm
Fits Into 7mm Hole
Replaces Auveco #19672
Acura CL, Legend, NSX, RL,
TI, TL, TSX & Vigor and
Honda Accord, Civic, CR-V,
Insight, Odyssey, Pilot,
Prelude & Ridgeline
1991 - On

UNIT PACKAGE: 25



20380

(Not Supplied By O.E.M.)

Black Nylon
Cable Strap
Length: 200mm (8")
Max. Bundle Dia: 44mm (1-3/4")
Fits Into 6.3mm (1/4") Hole
Import Cars

UNIT PACKAGE: 25

BMW CLIPS & FASTENERS



13158

(5113-1-804-205)
Nylon

Moulding Clip
With Sealer

UNIT PACKAGE: 50



21423

(51321-938-884)
White Nylon

Window Regulator Guide
3 & 5 Series
1989 - On

UNIT PACKAGE: 2



13172

(5147-1-840-961)
Nylon

Plastic Plug

UNIT PACKAGE: 25



17279

(5131-1-938-494)
Nylon

Windshield Moulding Clip
7 Series
1987-On

UNIT PACKAGE: 15



20333

(51-71-8-108-613)
White Nylon

Cowl & Trunk Trim Clip
Head Size: 11mm x 14mm
Stem Length: 11mm
Fits Into 9mm Hole
Series 3, 5, 7, & 8
1989 - On

UNIT PACKAGE: 25



20255

(51-47-1-928-808)
White Nylon

Scuff Plate Retainer
Head Size: 11mm x 15mm
Overall Length: 29mm
Series 3, 5 & 7
1987 - On

UNIT PACKAGE: 25



21429

(51-13-1-960-054)

White Nylon With
Blue Rubber Boot

Moulding Clip

Width: 22mm

Length: 35mm

Stem Length: 11mm

BMW

1999 – 92

UNIT PACKAGE: 25



17646

(51711-916-199)

Nylon

Headlight Cover Grommet

3, 5 & 7 Series

1984-On

UNIT PACKAGE: 25



21499

(BMW: 51-44-7-780-135;

Mercedes-Benz: 108-988-00-27)

Natural Nylon

Tubular Nut

Stud Size: 7mm

Head Diameter: 16mm

Stem Length: 16mm

Fits Into 8.5mm Hole

BMW, Mercedes-Benz

& Universal

UNIT PACKAGE: 25



21430

(51-13-2-251-394)

White Nylon With
Blue Rubber Boot

Moulding Clip

Width: 18mm

Length: 30.5mm

Stem Length: 10mm

BMW

1999 – 92

UNIT PACKAGE: 25



13170

(5141-1-802-258)

Natural Nylon

Barrel Nut

For 7mm Stud

Fits Into 8mm Hole

UNIT PACKAGE: 50



13167

(5121-6-442-159)

Nylon

Moulding Insert

UNIT PACKAGE: 25



20186

(51-14-1-807-495,

51-14-1-902-279)

Natural Nylon

Emblem Grommet

Head Diameter: 12mm

Stem Length: 8mm

Fits Into 6.8mm Hole

Series 3, 5, 6 & 7

2001 - 1986

UNIT PACKAGE: 15



13179

(BMW: 51-41-8-172-050;

VW: 481-867-197)

Black Nylon

Trim Panel Retainer

VW & BMW

UNIT PACKAGE: 50



21432

(51-13-8-166-675)

White Nylon With
Blue Rubber Boot

Moulding Clip

Width: 25.5mm

Length: 34mm

Stem Length: 11mm

BMW

2003 – 1995

UNIT PACKAGE: 25



20254

(51-13-8-124-389)

Black Plastic

Cowl Panel

Moulding Insert

Head Dia: 13mm

Stem Length: 11mm

Stem Diameter: 9mm

Use With Auveco 20388

Series 3 & 5

1989 - On

UNIT PACKAGE: 50



20253

(51-41-1-973-500)

White Nylon

Trim Panel Retainer

Top Head Dia: 14mm

Middle Head Dia: 15mm

Bottom Head Dia: 18mm

Stem Dia: 9mm

Stem Length: 15mm

Series 3, 5 & 7

1987 - On

UNIT PACKAGE: 50



21645

(Not Available From O.E.M.)
Black Nylon

Bumper & Wheel Opening
Push-Type Retainer
Head Diameter: 15mm
Stem Length: 15mm
Fits Into 6.3mm Hole
BMW
2004 - On

UNIT PACKAGE: 15



20734

(51-11-1-944-537)
Black Nylon

Bumper, Wheel Opening,
Scuff Plate & Interior Trim
Push-Type Retainer
Head Diameter: 20mm
Stem Length: 15mm
Fits Into 6.3mm Hole
Series 3, 5, 7 & X5
1989 - On

UNIT PACKAGE: 50



Not Actual Size

21305

(Not Available From O.E.M.)
Natural Nylon

Push-Mount Cable Strap
Overall Length: 156mm (6-1/8")
Strap Width: 5mm (3/16")
Snaps Into 6.3mm (1/4") Hole
Maximum Bundle Diameter:
40mm (1-9/16")
European Makes & Universal

UNIT PACKAGE: 25



20234

(51-11-1-908-077)
Black Nylon

Scuff Plate
Push-Type Retainer
Head Diameter: 15mm
Stem Length: 15mm
Fits Into 6.3mm Hole
Series 3, 5, & 7
1984 - On

UNIT PACKAGE: 50



20248

(51-11-8-174-185)
Black Nylon

Bumper Trim
Push-Type Retainer
Head Diameter: 20mm
Stem Length: 17mm
Fits Into 6.3mm Hole
Series 3, 5 & 7
1995 - On

UNIT PACKAGE: 25



21431

(BMW: 16-13-1-176-747;
Mercedes-Benz: 003-990-02-51)
Black Nylon

Nylon Flange Nut
Stud Size: 5mm
10mm Hex
Flange Diameter: 16mm
Overall Height: 11mm
BMW & Mercedes-Benz
1997 - On

UNIT PACKAGE: 25



20388

(51218-205-295)
Black Nylon

Cowl Vent
Push-Type Retainer
Head Diameter: 20mm
Stem Length: 16mm
Use With Auveco 20254
Series 5
1997 - On

UNIT PACKAGE: 50



16115

(5113-1-885-399)
Black Nylon

Push-Type Retainer
Head Size: 7mm x 15mm
Stem Length: 17mm
Fits Into 6mm x 6mm Hole

UNIT PACKAGE: 25



13221

(0712-9-929-706)
Plated

"U" Type Nut
2.9mm Screw Size
Panel Range: .5mm-1.5mm
Center of Hole To Edge: 6mm

UNIT PACKAGE: 50



20270

(51-48-1-915-464,
51-48-1-938-725)

Black Nylon

Hood & Trunk Insulation
Push-Type Retainer
Head Dia: 20mm
Stem Length: 9mm
Fits Into 7mm Hole
Series 3, 5 & 7
2001 - 84

UNIT PACKAGE: 25



20653

Gray Nylon

Wire Routing Clip
Inside Diameter: 7mm x 10mm
Fits Into 6mm Hole
BMW & Mercedes

UNIT PACKAGE: 50



13223

(BMW:0712-9-925-708;
Mercedes: 000-994-25-45)
Plated

"U" Type Nut
4.2mm (#8) Screw Size
Panel Range: 3mm -4mm
Center of Hole to Edge: 7mm

UNIT PACKAGE: 50

BMW (Cont.)	FIAT	HONDA (Cont.)
 <p>13216 Zinc "U" Type Nut 4.8mm (#10) Screw Size Panel Range: .9mm -2mm Center of Hole to Edge: 8mm UNIT PACKAGE: 25</p>	 <p>13198 (4-29-29-06) Black Nylon Interior Trim Retainer Head Dia: 16mm (41/64") Stem Dia: 9mm (11/32") Stem Length: 18mm (11/16") UNIT PACKAGE: 50</p>	 <p>18457 (91578-SV4-003) Nylon Radiator Grille Clip Accord 1994-On UNIT PACKAGE: 5</p>
 <p>13218 (BMW: 0712-9-925-737; Mercedes: 000-994-06-45) Plated "U" Type Nut 4.8mm (#10) Screw Size Panel Range: .5mm-1.7mm Center of Hole to Edge: 7mm UNIT PACKAGE: 50</p>	<p>GERMAN MADE FORD CLIPS & FASTENERS</p>	 <p>19439 (90116-S82-A01) Nylon Left Rear Bumper Fascia Clip Accord 1998-On UNIT PACKAGE: 5</p>
 <p>13215 (BMW: 0711-9-916-945; Mercedes: 000-994-14-45) Plated "U" Type Nut 4.8mm (#10) Screw Size Panel Range: .8mm -1.7mm Center of Hole To Edge: 11mm UNIT PACKAGE: 50</p>	 <p>12639 Nylon Body Side Moulding Clip w/Sealer UNIT PACKAGE: 25</p>	 <p>12576 (90665-SA0-9700) Nylon Side Protector Moulding Clip 20mm Wide 41mm Long Snaps Into 8mm Hole UNIT PACKAGE: 10</p>
 <p>13162 (0712-9-925-720) Plated "U" Type Nut 5.6mm Screw Size Panel Range: 1.2mm -2.0mm Center of Hole To Edge: 10mm UNIT PACKAGE: 50</p>	<p>HONDA</p>  <p>17195 (Isuzu: 8942180270) Black Nylon Grille Clip 13mm Wide 22mm Long Ford Escort, Honda, Isuzu, Mitsubishi & Plymouth Laser UNIT PACKAGE: 25</p>	



20603

(Honda:
71592-S5D-000)
White Nylon

Bumper Retainer
With Sealer
Head Size: 20mm x 23mm x 15mm
Stem Length: 22mm
2001 - On

UNIT PACKAGE: 15



20331

(90108-SS0-003)
Black Nylon

Bumper Clip
35mm Wide, 38mm High
Use with #8 Screw
Accord
1998 - On

UNIT PACKAGE: 5



20677

(71598-S30-013)
Black Nylon

Rear Bumper Moulding Clip
With Sealer
Width: 34mm
Length: 30mm
Overall Height: 31mm
Accord
1998 - On

UNIT PACKAGE: 5



15997

(34355-SD2-003)
Nylon

Side Marker Clip
Accord
1986-On

UNIT PACKAGE: 25



21186

(75305-SHJ-003)
White Nylon

Front And Side Door
Exterior Trim
Moulding Clip
Width: 13mm
Length: 14mm
Height: 13mm
Odyssey
2005 - On

UNIT PACKAGE: 15



21207

(91513-SMG-E11)
White Nylon

Fender Moulding Clip
Top Head Size: 7mm x 7mm
Bottom Head Size: 10mm x 19mm
Stem Length: 6mm
CR-V
2009 - On

UNIT PACKAGE: 25



14306

(90675-692-0031)
Nylon

Body Side
Moulding Clip
18mm Wide 15mm Long
Snaps Into 10mm Hole

UNIT PACKAGE: 25



14308

(90679-692-0030)
Nylon

Body Side Moulding Clip
10mm Wide; 12mm Long
Snaps Into 10mm Hole

UNIT PACKAGE: 25



17443

(91534-SE0-000)
Nylon

Body Side Moulding Clip
Accord
1986-On

UNIT PACKAGE: 25



21470

(75306-SZA-A01)
White Nylon

Moulding Clip
Top Head Size: 7.5mm x 10mm
Bottom Head Size: 9.5mm
Overall Height: 16mm
Pilot
2009 - On

UNIT PACKAGE: 15



21557

(75316-S9A-004)
White Nylon

Door Trim Moulding Clip
Head Size: 14mm x 16mm
Stem Length: 12mm
Fits Into 10mm Hole
Acura RDX and Honda CR-V
2002 - On

UNIT PACKAGE: 25



21559

(91512-SJ6-J01)
Black Nylon

Rocker Panel, Tail Light &
License Plate Housing Garnish
Moulding Clip
With Sealer

Top Head Size: 9mm x 12mm
Bottom Head Diameter: 13mm
Stem Diameter: 7.5mm
Stem Length: 9mm
Acura TSX and
Honda Civic & CR-V
1997 - On

UNIT PACKAGE: 25

HONDA CLIPS & FASTENERS

Sec. 22



20602
(75306-SV1-A01)
White Nylon
Body Side Moulding Clip
Head Size: 14mm x 14mm
Stem Length: 14mm
Accord
1998 - On
UNIT PACKAGE: 25



20785
(75305-SH4-003)
Red Nylon
Body Side Moulding Clip
Head Size: 14mm x 15mm
Stem Length: 14mm
Civic
1996 - On
UNIT PACKAGE: 10



21555
(91512-S50-003)
White Nylon
License Plate Garnish & Trim
Moulding Clip
With Sealer
Top Head Size: 12mm x 17mm
Bottom Head Size: 16mm x 17mm
Stem Diameter: 13mm
Stem Length: 12mm
Acura TSX & ZDX and
Honda Accord, Civic, Crosstour,
Fit, Insight, Odyssey & Pilot
2001 - On
UNIT PACKAGE: 25



21556
(75305-SM4-A01)
White Nylon
Fender Trim
Moulding Clip
Head Size: 13mm x 15mm
Stem Length: 15mm
Accord & Civic
2000 - 1990
UNIT PACKAGE: 25



20784
(75305-SH2-003)
Blue Nylon
Body Side Moulding Clip
Head Size: 12mm x 15mm
Stem Length: 15mm
Civic & CR-V
1996 - On
UNIT PACKAGE: 10



21419
(91503-S3Y-003)
White Nylon
Rocker, Pillars, Floor
& Exterior Trim
Moulding Clip
With Sealer
Top Head Size: 11mm x 13mm
Bottom Head Size: 15.5mm x 19mm
Stem Diameter: 12mm
Stem Length: 19mm
Insight
2006 - On
UNIT PACKAGE: 10



21639
(72431-S2X-003)
White Nylon
Moulding Clip
Top Head Size: 8mm x 10.5mm
Bottom Head Size: 11mm x 16mm
Overall Height: 14.6mm
Acura RSX and
Honda Civic, CR-Z & Insight
2006 - 01
UNIT PACKAGE: 25



21109
(75329-SH4-013)
Red Nylon
Door Moulding Clip
Head Size: 10mm x 12mm
Stem Length: 13mm
Accord
1990 - On
UNIT PACKAGE: 15



21558
(91504-SP1-003)
White Nylon
Rocker Panel & Fender
Moulding Clip
With Sealer
Top Head Size: 16mm x 18mm
Bottom Head Size: 18mm x 20mm
Stem Length: 15mm
Fits Into 10mm Hole
Acura Legend, MDX, RL
& ZDX and Honda Civic,
CR-V & Odyssey
1991 - On
UNIT PACKAGE: 25



20783
(75305-S0A-003)
White Nylon
Body Side Moulding Clip
Head Size: 6.5mm & 13mm x 18mm
Stem Length: 12mm
Civic, CR-V, Odyssey & Pilot
1999 - On
UNIT PACKAGE: 10



21308
(90602-SFA-004)
White Nylon
Cowl & Dash Moulding Clip
Top Head Size: 13mm x 14mm
Bottom Head Diameter: 16mm
Stem Length: 13mm
Acura RL and Honda Civic, Civic
Hybrid & Odyssey 2005 - On
UNIT PACKAGE: 25



21636
(71591-S5A-000)
White Nylon

Moulding Clip
With Sealer
Top Head Size: 13mm x 17mm
Bottom Head Size: 19mm x 22mm
Stem Length: 15mm
Civic
2005 - 2000

UNIT PACKAGE: 15



17981
(91510-SR3-003)
Nylon

Belt Moulding Clip
Civic
1992-On

UNIT PACKAGE: 10



21597
(91519-SCV-A01)
Tan and Green
Nylon

Moulding Clip
Element
2003 - On

UNIT PACKAGE: 10



20272
(91589-SV4-003)
Red Nylon

Belt Moulding Clip
Width: 20mm
Length: 24mm
Accord
1994 - On

UNIT PACKAGE: 25



21216
(91502-S9A-003)
White Nylon

Front & Rear Bumper
Moulding Clip
With Sealer
Head Size: 14mm x 26mm
Stem Length: 15mm
Height: 28mm
CR-V
2002 - On

UNIT PACKAGE: 10



19359
(91531-ST0-003)
Nylon

Door Moulding Clip
Civic
2, 3 & 4 Door
1995-On

UNIT PACKAGE: 10



20737
(91562-S84-A01)
Yellow Nylon

Belt Moulding Clip
Width: 20mm
Length: 27mm
Accord
1998 - On

UNIT PACKAGE: 10



17270
(72413-SF1-0030)
Nylon

Moulding Clip
Prelude
1988-On

UNIT PACKAGE: 15



19415
(91527-SM4-003, 91527-SZ3-003,
91561-S84-A01)
White Nylon

Belt Moulding Clip
Accord & Odyssey
1990-On

UNIT PACKAGE: 10



19737
(91515-SR4-003)
Red Nylon

Side Moulding Clip
Civic
1995 - 92

UNIT PACKAGE: 10



17442
(90601-SH3-014)
Nylon

Door Belt Moulding Clip
Civic
1988-On

UNIT PACKAGE: 10

HONDA CLIPS & FASTENERS



19740
(90666-SSO-003)
White Nylon

Roof Moulding Clip
Acura Integra & Legend
Prelude
1992 - On

UNIT PACKAGE: 10



17082
(90610-SF1-003)
Nylon

Rear Pillar
Garnish Clip
11mm Wide x 25mm Long
Fits Into 6mm Hole
Prelude 1988-On

UNIT PACKAGE: 15



19477
(91576-SV4-003)
Green Nylon

Windshield Right-Hand Corner
Moulding Clip
Acura 2.2CL, 2.3CL & 3.0CL;
Honda Accord & Odyssey
1994-On

UNIT PACKAGE: 10



19680
(91501-SM5-A00)
Gray Nylon

Roof Moulding Clip
Odyssey
1995 - On

UNIT PACKAGE: 10



17089
(90605-SF1-003)
Nylon

Rear Pillar Garnish
Moulding Clip
11mm Wide, 25mm long
Prelude 1988-On

UNIT PACKAGE: 10



19513
(91519-SR3-003)
Green Nylon

Windshield Side Moulding Clip
Civic
1995 - 92

UNIT PACKAGE: 10



17096
(91513-SM4-000)
Nylon

Rocker Panel
Moulding Clip
20mm Wide
20mm Long
Fits Into 12mm Hole
Accord
1991-On

UNIT PACKAGE: 10



20782
(75306-SDA-A01)
White Nylon

Moulding Clip
Head Size: 21mm x 27mm
Stem Length: 11mm
Accord
2003 - On

UNIT PACKAGE: 10



18405
(91562-SV4-003)
Yellow Nylon

Windshield Side Moulding Clip
Accord
1994-On

UNIT PACKAGE: 5



17320
(90612-AF1-003)
Nylon

Window Reveal
Moulding Clip
Upper Quarter Glass
Prelude
1988-On

UNIT PACKAGE: 15



19476
(91577-SV4-003)
Red Nylon

Windshield Left-Hand Corner
Moulding Clip
Acura 2.2CL, 2.3CL & 3.0CL;
Honda Accord & Odyssey
1994-On

UNIT PACKAGE: 10



18406
(91574-SV4-003)
White Nylon

Windshield Side Moulding Clip
Accord
1994-On

UNIT PACKAGE: 5



18865

(91529-SS0-003)
Gray Nylon

Windshield Moulding Clip
Prelude
1992-On

UNIT PACKAGE: 15



12580

(90674-692-0030)
Black Nylon

Windshield Moulding Clip
34mm Long, 16mm Wide
Includes Adhesive
Mounting Pads

UNIT PACKAGE: 10



19223

(91511-SR2-004)
Yellow Nylon

Windshield
Side Moulding Clip
Del Sol
1993-On

UNIT PACKAGE: 10

Please Order
In Unit Package
Quantities Not
Number Of
Pieces



14701

(90658-SB0-0030)
Black Nylon

Windshield Moulding Clip
34mm Long, 17mm Wide
Includes Adhesive
Mounting Pads

UNIT PACKAGE: 10



17285

(91525-SM4-003)
Pink Nylon

Windshield Side Moulding Clip
Accord 1990-On

UNIT PACKAGE: 15



18866

(91528-SS0-003)
White Nylon

Windshield Moulding Clip
Prelude
1992-On

UNIT PACKAGE: 15



21095

(91570-SDA-A01)
Blue Nylon

Windshield Moulding Clip
Width: 15mm
Length: 76mm
Accord
2003 - On

UNIT PACKAGE: 10



18864

(91530-SS0-003)
Black Nylon

Windshield Moulding Clip
Prelude
1992-On

UNIT PACKAGE: 15



Not Actual Size

14685

(90683-SC6-0030;
90683-SA6-0030)
Gray Nylon

Windshield Moulding Clip
60mm Long, 14mm Wide
Includes Adhesive
Mounting Pads

UNIT PACKAGE: 10

FasTrack® Web
Auveco's Cost
Recovery System
For Repair Fasteners...
Never Lose Money On
Fasteners Again!

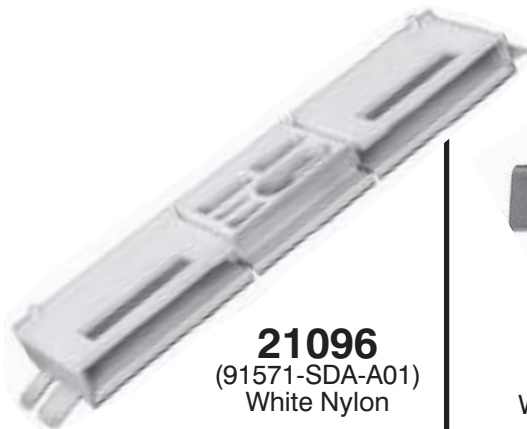

21096
(91571-SDA-A01)
White Nylon
Windshield Moulding Clip
Width: 16mm
Length: 75mm
Accord 2003 - On
UNIT PACKAGE: 10



20387
(91519-S5A-003)
Black Nylon
Windshield Moulding Clip
17mm Wide, 50mm Long
Upper Area Of Windshield
Civic Coupe
2001 - On
UNIT PACKAGE: 10



19670
(91541-SM4-003,
91542-SP0-003)
Aqua Nylon
Rear Window
Adjustable Moulding Clip
Accord
1990 - On
UNIT PACKAGE: 10

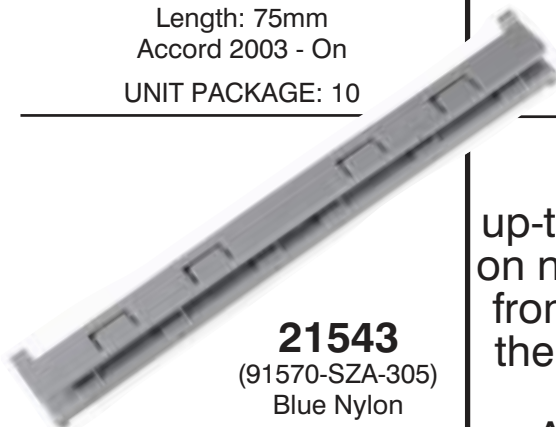

21543
(91570-SZA-305)
Blue Nylon
Windshield Moulding Clip
Width: 8mm
Length: 82mm
Acura ZDX and
Honda Odyssey & Pilot
2009 - On
UNIT PACKAGE: 5

For the most up-to-date information on new items available from Auveco, refer to the "Hot New Items" section fo the Auveco web site (www.auveco.com)



21094
(91572-SDA-A01)
White Nylon
Windshield Moulding Clip
Width: 14mm
Length: 62mm
Accord 2003 - On
Civic 2006 - On
UNIT PACKAGE: 10



20385
(91519-S5P-A01)
Blue Nylon
Windshield Moulding Clip
17mm Wide, 65mm Long
Upper Area Of Windshield
Civic Coupe
2001 - On
UNIT PACKAGE: 10



20386
(91520-S5A-003)
White Nylon
Windshield Moulding Clip
23mm Wide, 63mm Long
Lower Area Of Windshield
Civic Sedan
2001 - On
UNIT PACKAGE: 10

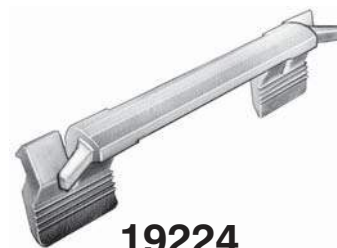

19224
(91572-SV2-003)
Natural Nylon
Windshield
Side Moulding Clip
Accord
1997-94
UNIT PACKAGE: 10



17475

(91520-SR3-003)
Red Nylon

Windshield Side Moulding Clip
Civic 1992-On

UNIT PACKAGE: 15



14700

(90672-SA6-0030)
Black Nylon

Windshield Moulding Clip
35mm Long
14mm Wide

UNIT PACKAGE: 25



15474

(90674-SC6-003)
Black Nylon

Back Glass Moulding Clip
15mm Wide, 38mm Long
Accord
1984-On

UNIT PACKAGE: 15



18404

(91572-SV4-003)
Pink Nylon

Windshield Side Moulding Clip
Accord
1994-On

UNIT PACKAGE: 10



14703

(90673-SC6-0030)
White Nylon

Windshield Moulding Clip
35mm Long
14mm Wide

UNIT PACKAGE: 25



17280

(91505-SG0-003)
Orange Nylon

Windshield Moulding Clip
Honda Prelude and
Acura Legend 1988-On

UNIT PACKAGE: 10



15472

(90664-SB0-004)
Black Nylon

Windshield Moulding Clip
11mm Wide, 35mm Long
Honda
1983-On

UNIT PACKAGE: 15



17281

(90694-SB0-003)
Black Nylon

Windshield Moulding Clip
Prelude
1983-On

UNIT PACKAGE: 15



14705

(90713-SB0-003)
Black Nylon

Quarter Window
Moulding Clip
18mm Long
18mm Wide
Snaps Into 5mm Hole

UNIT PACKAGE: 25



17454

(74807-SB0-004)
Black Nylon

Rear Window Moulding Clip
1983-On

UNIT PACKAGE: 25



17282

(91534-SM4-003)
White Nylon

Windshield Moulding Clip
Accord 1990-On
Acura Legend 1991-On

UNIT PACKAGE: 10

All Items Are
Available In Bulk.
Call For A Quotation.



19115

(91528-S01-A01)
Blue Nylon

Drip Moulding Clip
4 Door Civic
1995-On

UNIT PACKAGE: 15



16825

(74806-SB6-003)
White Nylon

Back Glass Moulding Clip
33mm Wide, 30mm Long
Snaps Into 6mm Hole
Civic, Hatchback
1984-On

UNIT PACKAGE: 25



16861

(90664-692-0300)
Black Nylon

Windshield Reveal Moulding Clip
40mm Wide, 40mm Long
Prelude
1979-On

UNIT PACKAGE: 25



17488

(73156-SS0-004)

Window Moulding Clip
Left-Hand Corner
Prelude
1992-On

UNIT PACKAGE: 5



14288

(90655-SAO-0030)
Natural Nylon

#6 Screw Size
9.5mm Wide; 9.5mm Long
Snaps Into 6mm x 6mm Hole

UNIT PACKAGE: 50



14317

(34301-692A-0000)
White Nylon

#8 Screw Size
9.5mm Wide; 9.5mm Long
Snaps Into 6mm x 6mm Hole

UNIT PACKAGE: 50



14255

(Honda: 75522-611-0000;
Mazda: 9991-00-412;
Mitsubishi: MS-480001)
Black Nylon

#8 Screw Size
9.5mm Wide, 9.5mm Long
Snaps Into 7mm x 7mm Hole

UNIT PACKAGE: 50



20350

(90866-SAO-000)
Natural Nylon

Door Trim
Nylon Nut
#4 Screw Size
Head Size: 13mm x 13mm
Stem Length: 7mm
Civic
1998 - On

UNIT PACKAGE: 25



20351

(90666-SD9-000)
Natural Nylon

Nylon Nut
#14 (M6.3) Screw Size
Head Size: 16mm x 16mm
Stem Length: 8mm
CR-V
1997 - On

UNIT PACKAGE: 25



17058

(90676-SA7-003)
Natural Nylon

Headlight Adjusting
Screw Nut
M5-.8 Screw Size
Prelude & Accord
1986-On

UNIT PACKAGE: 25



14274

(Honda: 75521-611-0000;
Mazda: 9991-00-601;
Nissan: 96706-P0105
Toyota: 90189-06010)
Natural Nylon

#10 Screw Size
13mm Wide, 13mm Long
Snaps Into 8.5mm x
8.5mm Hole

UNIT PACKAGE: 25



17609

(91635-SM4-003)
Black Nylon

Headlight To Grille
Spacer Bracket Grommet
#10 Screw Size
Accord
1990-On

UNIT PACKAGE: 10



14287

(90656-671-6310M1)
Natural Nylon

#14 (1/4") Screw Size
13mm Wide, 15mm Long
Snaps Into 8.5mm x 10.5mm Hole

UNIT PACKAGE: 50



19117

(91619-SM4-003,
91619-SM4-0030)
Natural Nylon

Center Pillar Garnish
Moulding (Oval) Screw Grommet
#4 Screw Size
Odyssey & Accord Wagon
1991-On

UNIT PACKAGE: 25



20612

(90603-S7S-003)
Blue Nylon
With Sealer

Cowl Vent Grommet
Flange Size: 10mm x 24mm
Stem Length: 6mm
Use With Auveco 20611
Accord
2003 - On

UNIT PACKAGE: 15



14294

(90675-SA6-0030)
Natural Nylon

Screw Grommet
With Sealer
#6 Screw Size
15mm Wide, 15mm Long
Stem Length: 12mm
Snaps Into 7mm x 7mm Hole

UNIT PACKAGE: 15



14313

(Honda: 90662-671-0030;
Mazda: 9991-00-503;
Nissan: 62698-V7000,
68425-H5000)
Natural Nylon

#10 Screw Size
17mm Wide
17mm Long
Snaps Into 8mm x 8.5mm Hole
Also For Mazda & Nissan

UNIT PACKAGE: 25



14280

(90681-693-0000)
Natural Nylon

Screw Grommet
#6 Screw Size
10mm Wide 17mm Long
Stem Length: 15mm
Fits Into 7mm x 13mm Hole

UNIT PACKAGE: 25



14296

(90668-688-0030)
Natural Nylon

Screw Grommet
With Sealer
#6 Screw Size
11mm Wide, 14mm Long
Stem Length: 10mm
Snaps Into 7mm x 10mm Hole

UNIT PACKAGE: 25



21635

(91603-SL0-000)
Natural Nylon

M4.8 (#10) Screw Size
Head Diameter: 16mm
Stem Length: 7mm
Fits Into 8mm x 8mm Hole
Insight
2006 - 2000

UNIT PACKAGE: 25



14690

(Honda: 90683-693-0000;
Nissan: 78856-R4301)
White Nylon

Screw Grommet
#10 Screw Size
12mm Wide
19mm Long
Stem Length: 17mm
Fits Into 8mm x 15mm Hole

UNIT PACKAGE: 25



19679
(91641-SH3-013)
Yellow Nylon
w/ Steel Insert

Garnish Moulding Grommet
Head Diameter: 14mm x 26mm
Acura Integra, Honda Civic
& Prelude
1988 - On

UNIT PACKAGE: 10



19307
(91620-SR2-003)
Natural Nylon

Center Pillar
Screw Grommet
#4 Screw Size
Del Sol
1993-On

UNIT PACKAGE: 10



19646
(90665-SM4-000)
Yellow Nylon

Front Door
Screw Grommet
#6 Screw Size
Head Diameter: 14mm
Stem Length: 10mm
Fits Into 7mm x 7mm Hole
Prelude
1997 - On

UNIT PACKAGE: 15



14268
(Honda: 90672-671-8110M1;
Toyota: 90189-04013)
White Nylon

Screw Grommet
#6 Screw Size
Head Diameter: 14mm
Stem Length: 15mm
Fits Into 7mm x 7mm Hole

UNIT PACKAGE: 25



14281
(Honda: 90662-693-0030;
Toyota: 90189-04066)
White Nylon

Screw Grommet
#6 Screw Size
Head Diameter: 14mm
Stem Length: 10mm
Fits Into 7mm x 7mm Hole

UNIT PACKAGE: 25



19741
(90670-SG0-003,
91626-SH3-003)
Natural Nylon

Door Panel Screw Grommet
#8 (M4.2) Screw Size
Head Diameter: 12mm
Stem Length: 16mm
Fits Into 7mm x 7mm Hole
Civic & CR-V
1993-On

UNIT PACKAGE: 15



14695
(Honda: 90661-SC7-0030;
Mazda: H001-50-841;
Mitsubishi: MS-480012;
Nissan: 01651-00481, 74798-S9000;
Toyota: 90189-06042)
White Nylon

Screw Grommet
#8 (M4.2) Screw Size
Head Diameter: 16mm
Stem Length: 17mm
Fits Into 8mm x 8mm Hole

UNIT PACKAGE: 25



20303
(90664-SB3-003)
Natural Nylon

Trim Panel
Screw Grommet
#8 (M4.2) Screw Size
Head Diameter: 15mm
Stem Length: 15mm
Fits Into 8mm x 8mm Hole
Accord
1998 - On

UNIT PACKAGE: 10



20954
(90682-SEA-003)
Black Nylon

Fender Apron Screw Grommet
#8 (M4.2) Screw Size
Head Diameter: 20mm
Stem Length: 12mm
Fits Into 9mm Square Hole
Acura TSX and
Honda Civic & Odyssey
2004 - On

UNIT PACKAGE: 25



21205
(90682-SDA-A01)
Black Nylon

Rear Bumper
Screw Grommet
M4.8 (No. 10) Screw Size
Head Size: 14mm x 14mm
Stem Length: 14mm
Civic
2009 - On

UNIT PACKAGE: 15



19650
(90106-SW3-003)
White Nylon

Bumper Grommet
Head Size: 18mm x 20mm
Stem Length 19mm
Fits Into 8mm x 11mm Hole
Use With 19470
Accord, Odyssey
& Prelude
1995 - On

UNIT PACKAGE: 10



21521
(90107-S0X-A01)
Black Nylon

Screw Grommet
M4.8 (#10) Screw Size
Head Size: 16mm x 16mm
Stem Length: 7mm
Acura CL, MDX, RL,
3.2 CL & 3.5RI and
Honda Accord, Pilot,
Ridgeline & S2000
1996 - On

UNIT PACKAGE: 25



18115
(90676-SR4-003)
Nylon

Reveal Moulding
Pin Retainer
Civic
1993-On

UNIT PACKAGE: 15



14291
(66435-648-0000)
Black Nylon

Retaining Clip
Head Diameter: 11mm
Stem Length: 13mm
Snaps Into 5mm Hole
Panel Thickness: 5mm

UNIT PACKAGE: 50



19143
(91623-SM2-0030)
Natural Nylon

Door Glass
Guide Grommet
#6 Screw Size
Prelude &
2 Door Accord
1990-On

UNIT PACKAGE: 10



18415
(71144-SR3-A00)
Natural Nylon

Bumper Grommet
M4.2 (#8) Screw Size
Civic
1993-On

UNIT PACKAGE: 25



14282
(90687-SA5-0030)
Black Nylon

Retaining Clip
Head Diameter: 13mm
Stem Length: 15mm
Snaps Into 5mm Hole
Panel Thickness: 4mm

UNIT PACKAGE: 50



19454
(90651-SL9-0130)
Gray Nylon

Rear Bumper Fascia
Grommet
#8 (M4.2) Screw Size
Accord
1996 - 94

UNIT PACKAGE: 15



19533
(90107-S10-003)
Black Nylon

Wheel Well Moulding
Screw Grommet
#10 Screw Size
CR-V
1997 - On

UNIT PACKAGE: 25



20472
(91512-SR3-004)
White Nylon

Tubular Nut
With Sealer & Sealed End
3mm Stud Size
Head Dia: 8.5mm
Fits Into 6mm Hole
Emblem Nut
Acura Integra,
Honda Accord, Civic, CR-V
& Prelude
1994 - On

UNIT PACKAGE: 10



18157
(90672-671-003)
Gray Nylon

Headliner & Cowl Grille
Retaining Clip
Head Diameter: 13mm
Stem Length: 16mm
Panel Thickness: 5mm
Fits Into 5mm Hole
Accord 1986-On

UNIT PACKAGE: 25



19734
(90107-SX0-003)
Black Nylon

Bumper Grommet
#10 Screw Size
Acura 2.2CL, 2.3CL, 2.5TL,
3.2TL, & 3.5RL;
Honda Accord & Prelude
1996 - On

UNIT PACKAGE: 15



20381

(Honda: 90667-671-013ZA;
Mitsubishi: MC440901;
Nissan: 62660-48600-1)
Black Nylon

Trim Panel Retaining Clip
Head Diameter: 16mm
Stem Diameter: 7mm
Stem Length: 16mm
Honda, Mitsubishi & Nissan

UNIT PACKAGE: 25



20334

(90667-SOD-003ZC)
Black Nylon

Trunk Garnish Retainer
Head Dia: 18mm
Stem Dia: 7.5mm Sq.
Stem Length: 20mm
Civic
1998 - On

UNIT PACKAGE: 15



19506

(90666-SA7-003ZW)
Black Nylon

Trunk Lining Retainer
Head Diameter: 16mm
Stem Diameter: 5mm Square
Stem Length: 16mm
Acura 2.5TL, 3.2TL, 3.5,
Integra & Legend,
Honda Accord Wagon
& Prelude
1987 - On

UNIT PACKAGE: 15



20882

(91501-SEA-003)
Black Nylon

Cowl & Garnish Retainer
Head Diameter: 20mm
Stem Diameter: 7mm
Stem Length: 15mm
Civic
2006 - On

UNIT PACKAGE: 10



16781

(Honda: 90670-692-0030;
Toyota: 90467-09065)
Black Nylon

Retaining Clip
Head Dia: 15mm
Stem Length: 20mm
Panel Thickness: 11mm
Fits Into 7mm Hole

UNIT PACKAGE: 25



19744

(90669-SP0-003ZA)
Black Nylon

Trunk Trim Retainer
Head Diameter: 16mm
Stem Diameter: 6mm
Stem Length: 27mm
Civic
1998 - On

UNIT PACKAGE: 10



21303

(90671-SOD-003ZK)
Black Nylon

Trunk Lid &
Interior Trim Retainer
Head Diameter: 18mm
Stem Diameter: 7mm x 7mm
Stem Length: 13mm
Accord
2010 - On

UNIT PACKAGE: 25



14289

(90666-SAO-0030)
Black Nylon

Retainer
Head Diameter: 13mm
Stem Length: 16mm
Snaps Into 5mm Hole

UNIT PACKAGE: 25



16775

(Honda: 90667-SA7-0030;
Nissan: 89427-98070)
Black Nylon

Trim Panel Retainer
Head Dia: 20mm
Stem Length: 15mm
Fits Into 5mm Hole

UNIT PACKAGE: 25



19470

(90108-SW3-003)
Black Nylon

Bumper Retainer
Head Diameter: 16mm
Stem Diameter: 4mm
Stem Length: 21mm
Use With 19650
Accord, Odyssey & Prelude
1995-On

UNIT PACKAGE: 15



16776

(Honda: 90667-SAO-0030;
Nissan: 76996-01P02)
Black Nylon

Trim Panel Retainer
Head Dia: 18mm
Stem Length: 20mm
Fits Into 6mm Hole

UNIT PACKAGE: 25

Please E-Mail
Your New Item
Suggestions
To mail@auveco.com



15998

(90700-SB2-003)
Black Nylon

Hood Insulation Retainer
Head Dia: 30mm
Stem Length: 9mm
Fits Into 6mm Hole
Honda Prelude 1985-On
UNIT PACKAGE: 15



18114

(91520-SM4-C010)
Black Nylon

Hood Insulation Retaining Clip
Head Diameter: 10mm
Stem Length: 10mm
Panel Thickness: 4mm
Fits Into 6mm Hole
Honda & Acura
1990-On
UNIT PACKAGE: 25



14323

(38529-689A-6300)
Black Nylon

Retaining Clip
Head Diameter: 18mm
Stem Length: 15mm
Snaps Into 7mm Hole
Panel Thickness: 4mm
UNIT PACKAGE: 25



18746

(90700-SJ4-000)
Black Nylon

Hood Insulation Retainer
Head Diameter: 30mm
Stem Diameter: 15mm x 18mm
Stem Length: 10mm
Acura Legend 1991 - On
Honda 1998 - On
UNIT PACKAGE: 15



19682

(91518-S10-003)
Black Nylon

Hood Seal Retaining Clip
Head Diameter: 11mm
Stem Length: 8mm
Fits Into 6mm Hole
Odyssey
1999 - On
UNIT PACKAGE: 25



16779

(Honda: 74842-659-0030;
Toyota: 90467-12078)
Black Nylon

Retaining Clip
Head Dia: 18mm
Stem Length: 15mm
Panel Thickness: 6mm
Fits Into 8mm Hole
UNIT PACKAGE: 25



20609

(91501-S1K-003,
91501-STK-003)
Black Nylon

Hood Insulation Retainer
Head Diameter: 30mm
Stem Diameter: 15mm x 20mm
Stem Length: 14mm
Acura 3.5RL & RSX And
Honda Civic & CR-V
2000 - On
UNIT PACKAGE: 25



19114

(91518-SM4-003)
Black Nylon

Hood & Trunk Moulding
Retaining Clip
Head Diameter: 12mm
Stem Length: 9mm
Fits Into 6mm Hole
Acura Integra & Honda Civic
1994 - On
UNIT PACKAGE: 10



14319

(90687-671-0030)
Black Nylon

Retaining Clip
Head Diameter: 20mm
Stem Length: 20mm
Snaps Into 10mm Hole
Panel Thickness: 6mm
UNIT PACKAGE: 25



21652

(91501-SWA-003)
Black Nylon

Hood Insulation Retainer
Head Diameter: 30mm
Stem Diameter: 21mm
Stem Length: 14mm
Civic
2012 - On
UNIT PACKAGE: 25



17205

(91501-SM4-003)
Black Nylon

Cowl Top Retaining Clip
Head Dia: 14mm
Stem Length: 15mm
Fits Into 6mm Hole
Accord
1990-On
UNIT PACKAGE: 15



20611

(90602-S7S-003)
Blue Nylon

Cowl Vent Retainer
Top Head Diameter: 12mm
Bottom Head Diameter: 16mm
Stem Diameter: 3mm
Stem Length: 7mm
Use With Auveco 20612
Accord
2003 - On
UNIT PACKAGE: 25



21107
(90602-SX0-003)
White Nylon

Cowl Vent Retainer
Top Head Diameter: 12mm
Bottom Head Diameter: 16mm
Stem Diameter: 4mm
Stem Length: 13mm
Acura MDX, Honda Civic,
Insight, Odyssey & Prelude
1995 - On

UNIT PACKAGE: 10



21554
(91560-S7A-003)
Black Nylon

Trim Panel Retainer
With Sealer
Top Head Diameter: 13mm
Middle Head Diameter: 16mm
Bottom Head Diameter: 15mm
Stem Diameter: 9.5mm
Stem Length: 11mm
Crosstour, Fit & Odyssey
2010 - 05

UNIT PACKAGE: 25



21208
(91560-SLJ-J01)
Gray Nylon

Door Trim Panel Retainer
Top Head Diameter: 13mm
Middle Head Diameter: 16mm
Bottom Head Diameter: 18mm
Stem Length: 12mm
Fits Into 8.5mm Hole
Acura RDX and Honda Civic,
CR-V & Pilot
2009 - On

UNIT PACKAGE: 10



21417
(90602-TA0-003)
Blue Nylon

Cowl Vent Retainer
Top Head Size: 10mm x 14mm
Bottom Head Diameter: 16mm
Stem Diameter: 8mm
Acura TSX & ZDX and Honda
Accord & Fit 2008 - On

UNIT PACKAGE: 10



21149
(91560-S84-A01)
White Nylon

Trim Panel Retainer
Top Head Diameter: 13mm
Middle Head Diameter: 16.5mm
Bottom Head Diameter: 15mm
Stem Diameter: 9.5mm
Stem Length: 11mm
Accord & Element
2003 - On

UNIT PACKAGE: 25



21676
(91560-SZW-J01)
Dull Yellow Nylon

Windshield Moulding &
Interior Trim Retainer
Top Head Diameter: 13mm
Middle Head Diameter: 16mm
Bottom Head Diameter: 18mm
Stem Diameter: 9.5mm
Stem Length: 12mm
Civic
2012 - On

UNIT PACKAGE: 25



19145
(91560-SP0-003)
Gray Nylon

Door Trim Panel Retainer
Small Head Dia: 13mm
Large Head Dia: 17mm
Stem Diameter: 9mm
Stem Length: 12mm
Acura & Honda Accord, Civic,
Prelude, Odyssey & Del Sol
1991-On

UNIT PACKAGE: 25



21638
(91560-S0X-A01)
White Nylon

Trim Panel Retainer
With Sealer
Top Head Diameter: 13mm
Middle Head Diameter: 16.5mm
Bottom Head Diameter: 15mm
Stem Diameter: 9.5mm
Stem Length: 11mm
Accord, CR-V, Fit & Odyssey
1999 - On

UNIT PACKAGE: 15



21675
(91560-SZW-003)
Green Nylon

Door Panel &
Interior Trim Retainer
Top Head Diameter: 13mm
Middle Head Diameter: 16mm
Bottom Head Diameter: 18mm
Stem Diameter: 9.5mm
Stem Length: 11mm
Civic
2012 - On

UNIT PACKAGE: 25



20411
(91560-S84-A11)
Black Nylon

Windshield Garnish
Pillar Retainer
Top Head Dia: 13mm
Middle Head Dia: 16mm
Bottom Head Dia: 14.5mm
Stem Diameter: 9.5mm
Stem Length: 12mm
Acura 3.2CL, Honda Accord,
Insight & Odyssey
1998 - On

UNIT PACKAGE: 15



20959

(91560-S9A-A01)
Blue Nylon

Door Panel Retainer
Top Head Diameter: 13mm
Middle Head Diameter: 16mm
Bottom Head Diameter: 15mm
Stem Diameter: 9.5mm
Stem Length: 13mm
Acura TL & TSX and
Honda Accord, Civic, CR-V
& Odyssey
2002 - On

UNIT PACKAGE: 25



21087

(90602-SAA-003)
Orange Nylon

Cowl Vent &
Radiator Support Retainer
Top Head Diameter: 12mm
Middle Head Diameter: 16mm
Bottom Head Diameter: 18mm
Stem Diameter: 9.7mm
Stem Length: 14mm
Fit & CR-V
2003 - On

UNIT PACKAGE: 15



21206

(91560-S6A-003)
Orange Nylon

Rear Liftgate Retainer
Top Head Diameter: 13mm
Middle Head Diameter: 16mm
Bottom Head Diameter: 18mm
Stem Length: 14mm
Fits Into 8.5mm Hole
Fit
2009 - On

UNIT PACKAGE: 15



20610

(Honda:
91560-SM4-003)
White Nylon

Door Trim Panel Retainer
Top Head Diameter: 13mm
Middle Head Diameter: 18mm
Bottom Head Diameter: 16mm
Stem Diameter: 9mm
Stem Length: 15mm
Accord
1990 - On

UNIT PACKAGE: 25



18294

(91566-SP0-003)
White Nylon

Trim Panel Retainer
Small Head Dia: 13mm
Large Head Dia: 18mm
Stem Length: 14mm
Fits Into 9mm Hole
Honda 1990-On

UNIT PACKAGE: 15



21059

(90602-S5A-003)
Blue Nylon

Cowl Vent Retainer
Top Head: 12mm x 13mm
Middle Head Diameter: 16mm
Bottom Head Diameter: 18mm
Stem Diameter: 8.5mm x 8.5mm
Stem Length: 14mm
Acura RSX and
Honda Civic & CR-V
2001 - On

UNIT PACKAGE: 15

**Please Order
In Unit Package
Quantities Not
Pieces**



21141

(91561-SJD-003)
Black & White Nylon

Pillar, Rocker Panel &
Floor Retainer
Top Head Diameter: 15mm
Middle Head Diameter: 16mm
Bottom Head Diameter: 18mm
Stem Diameter: 8mm
Stem Length: 13mm
Civic & Pilot
2004 - On

UNIT PACKAGE: 10



21458

(91567-S3M-000)
Black Nylon

Weatherstrip Retainer
Head Diameter: 10mm
Stem Diameter: 5.5mm
Stem Length: 7mm
Accord, Civic & Odyssey
2003 - On

UNIT PACKAGE: 25



14299

(73862-672-0030)
White Nylon

Weatherstrip Retainer
7mm Wide
16mm Long
Stem Length: 5mm
Fits Into 5mm Hole

UNIT PACKAGE: 50



14328

(90664-671-0030)
White Nylon

Weatherstrip Retainer
7mm Wide
16mm Long
Stem Length: 10mm
Fits Into 5mm Hole

UNIT PACKAGE: 50

HONDA CLIPS & FASTENERS



19673
(72311-S10-003)
Black Nylon

Weatherstrip Retainer
Head Size: 10mm x 15mm
Stem Diameter: 5mm
Stem Length: 10mm
CR-V
1997 - On

UNIT PACKAGE: 15



19171
(91568-SR2-003)
Green Nylon

Weatherstrip Retainer
Head Size: 5mm x 15mm
Stem Length: 10mm
Fits Into 5mm Hole
Odyssey
1995 - On

UNIT PACKAGE: 100



14290
(90692-SA5-0030)
Black Nylon

Niflock Rivet
Diameter: 5mm
Head Diameter: 12mm
Stem Length: 17mm

UNIT PACKAGE: 25



18818
(91513-SE0-003)
Natural Nylon

Hood Seal Retainer
Head Size: 7mm x 16mm
Stem Length: 12mm
Fits Into 5mm Hole
Accord & Prelude
1983-On

UNIT PACKAGE: 25



19683
(91502-S84-A11)
Black Nylon

Cowl Vent
Retaining Clip
Head Diameter: 6mm x 16mm
Stem Length: 14mm
Fits Into 6mm Hole
Odyssey
1999 - On

UNIT PACKAGE: 15



14293
(90674-SA5-0030)
Black Nylon

Niflock Rivet
Diameter: 6mm
Head Diameter: 11mm
Stem Length: 23mm

UNIT PACKAGE: 25



18877
(91530-SP1-003)
Red Nylon

Weatherstrip Retainer
Head Size: 5mm x 15mm
Stem Length: 10mm
Fits Into 6mm Hole
Acura 3.5 RL & Honda
Accord, Civic & Odyssey
1992-On

UNIT PACKAGE: 25



19483
(91515-SR3-000)
Black Nylon

Rear Hood Cowl
Weatherstrip Retaining Clip
Head Size: 8mm x 18mm
Stem Length: 15mm
Fits Into 7mm Hole
Acura Integra, Honda Civic,
CR-V & Del Sol
1992 - On

UNIT PACKAGE: 25



19186
(90657-SB0-003)
Black Nylon

Front Bumper Cover
Push-Type Retainer
Head Diameter: 11mm
Stem Length: 10mm
Fits Into 8mm Hole
Acura Legend, Honda Accord &
Odyssey
1991-On

UNIT PACKAGE: 10



19116
(91530-ST5-003)
Natural Nylon

Weatherstrip Retainer
Head Size: 5mm x 15mm
Stem Length: 10mm
Fits Into 6mm Hole
Front & Rear Doors
Civic
1995 - On

UNIT PACKAGE: 10

**Body Hardware
&
Specialty Fasteners
= Auveco**



19547
(91508-S50-003)
Black Nylon

Cowl Top Retainer
Head Diameter: 17mm
Stem Length: 13mm (Exc. Pin)
Fits Into 9mm Hole
Accord & Odyssey
1998 - On

UNIT PACKAGE: 5



18165

(91508-SR3-000)
Black Nylon

Cowl Panel
Push-Type Retainer
Head Diameter: 17mm
Stem Length: 9mm
Fits Into 8mm Hole
Honda 1990-On

UNIT PACKAGE: 10



19118

(91501-S04-003)
Black Nylon

Front Fender
Push-Type Retainer
Head Diameter: 20mm
Stem Length: 10mm
Fits Into 8mm Hole
Civic & Del Sol 1993-On

UNIT PACKAGE: 15



20986

(91505-S9A-003)
Black Nylon

Front Bumper
Push-Type Retainer
With Internal Metal Insert
Head Diameter: 20mm
Stem Length: 13mm
Fits Into 10mm Hole
Civic 2006 - On

UNIT PACKAGE: 10



20247

(Mitsubishi: MR200300)
Black Nylon

Fender & Bumper
Push-Type Retainer
Head Diameter: 18mm
Stem Length: 12mm
Fits Into 9mm Hole
Honda & Mitsubishi
1998 - On

UNIT PACKAGE: 15



21651

(91501-TR0-003)
Black Nylon

Fender Push-Type Retainer
Head Diameter: 20mm
Stem Length: 10mm
Fits Into 8mm Hole
Civic
2012 - On

UNIT PACKAGE: 25



19239

(Honda:
91512-SX0-003;
GM: 11519949

Mitsubishi: MU000319)
Black Nylon

Front Fender & Bumper Support
Push-Type Retainer
Head Diameter: 20mm
Stem Length: 11mm
Fits Into 8mm Hole
Acura, GM, Mitsubishi and
Honda Accord, Prelude & Odyssey
1994 - On

UNIT PACKAGE: 25



17192

(91508-SM4-003)
Black Nylon

Cowl Panel Push-Type Retainer
Head Dia: 18mm
Stem Length: 14mm
Fits Into 8mm Hole
Accord 1990-On

UNIT PACKAGE: 10



21297

(91503-S7A-003)
Black Nylon

Front Bumper
Push-Type Retainer
Head Diameter: 20mm
Stem Length: 11mm
Fits Into 10mm Hole
Civic
2010 - On

UNIT PACKAGE: 15



20608

(91503-S0K-A01)
Black Nylon

Grille Mounting
Push-Type Retainer
Head Diameter: 20mm
Stem Length: 14mm
Fits Into 10mm Hole
Element
2003 - On

UNIT PACKAGE: 15



19453

(90505-SX0-003)
Black Nylon

Garnish Side Protector
Push-Type Retainer
Head Diameter: 18mm
Stem Length: 15mm
(Not Including The Pin)
Fits Into 8mm Hole
Odyssey
1995 - On

UNIT PACKAGE: 15



19233

(Honda: 91503-SZ3-003;
Black Nylon

Front Bumper Push-Type Retainer
Head Diameter: 20mm
Stem Length: 13mm
Fits Into 10mm Hole
Acura 3.5 RL Sedan & Honda
1996-On

UNIT PACKAGE: 15



21173

(91506-S9A-003)
Black Nylon

Bumper & Splash Shield
Push-Type Retainer
With Metal Insert
Head Diameter: 20mm
Stem Length: 16mm
Fits Into 10mm Hole
Acura and Honda Accord, Civic,
CR-V & Fit 2009-04

UNIT PACKAGE: 10



20564

(91503-SZ5-003)
Black Nylon

Front & Rear Bumper
Push-Type Retainer
Head Diameter: 20mm
Stem Length: 18mm
Fits Into 10mm Hole
Acura 3.5RL And
Honda Accord & Odyssey
1996 - On

UNIT PACKAGE: 15



21190

(91550-S50-000ZL)
Black Nylon

Interior Trim
Push-Type Retainer
Head Diameter: 16mm
Stem Length: 14mm
Fits Into 7mm Hole
Civic, CR-V, Element & Insight
2006 - 2000

UNIT PACKAGE: 15



21477

(91550-S50-000ZK)
Gray Nylon

Push-Type Retainer
Head Diameter: 16mm
Stem Length: 14mm
Fits Into 7mm Hole
Civic, CR-V, Element & Insight
2006 - 2000

UNIT PACKAGE: 15



20910

(91505-ST7-003ZA)
Black Nylon

Door Panel
Push-Type Retainer
Head Diameter: 17mm
Stem Length: 12mm
Fits Into 8mm Hole
CR-V and S2000
2000 - On

UNIT PACKAGE: 10



19416

(Toyota: 90467-09139)
Black Nylon

Bumper Cover & Wheel Housing
Push-Type Retainer
Head Diameter: 18mm
Stem Length: 15mm
Fits Into 9mm Hole
Honda, Mazda 626 & Toyota Corolla
1992-On

UNIT PACKAGE: 15



16782

(Honda:
91545-SE0-0030-W1;
Nissan: 63848-01G00)
Black Nylon

Push-Type Retainer
Head Dia: 20mm
Stem Length: 14mm
Fits Into 8mm Hole

UNIT PACKAGE: 25



21454

(91503-SHJ-A01)
Black Nylon

Front Bumper
Push-Type Retainer
Head Diameter: 20mm
Stem Length: 13mm
Fits Into 10mm Hole
Odyssey
2005 - On

UNIT PACKAGE: 10



14286

(90673-692-0030)
Black Nylon

Push-Type Retainer
15mm Wide
20mm Long
Stem Length: 9mm
Fits Into 8mm x 11.5mm Hole

UNIT PACKAGE: 25



17287

(90687-SB0-003,
90687-SB0-013)
Black Nylon

Cowl Vent Panel Retainer
Head Dia: 13mm
Stem Length: 11mm
Fits Into 6mm Hole
Prelude 1983-On

UNIT PACKAGE: 25



14697

(GM: 94198687;
Honda: 90657-SA6-0030;
Mazda: N304-13-356-A)
Black Nylon

Push-Type Retainer
Head Dia: 14mm
Stem Length: 11mm
Fits Into 7mm Hole

UNIT PACKAGE: 25



14696

(Honda: 90684-SA5-003;
Isuzu: 8942981190;
Nissan: 10998-30880)
Black Nylon

Push-Type Retainer
Head Dia: 15mm
Stem Length: 11mm
Fits Into 6mm Hole

UNIT PACKAGE: 25

**Please Order In Unit
Package Quantities
Not Number Of Pieces**



19311
(90683-SA5-003)
Black Nylon

Front Fender Skirt
Push-Type Retainer
Head Diameter: 15mm
Stem Length: 13mm
Fits Into 6mm Hole
Prelude
1996-92

UNIT PACKAGE: 15



17081
(91524-SE0-003)
Black Nylon

Cowl Push-Type Retainer
Head Dia: 18mm
Stem Length: 12mm
Fits Into 6mm Hole
Accord 1986-On

UNIT PACKAGE: 25



17379
(91512-SM4-003)
Black Nylon

Fender Splash Shield
Push-Type Retainer
Head Diameter: 20mm
Stem Length: 9mm
Fits Into 8mm Hole
Accord
1990-On

UNIT PACKAGE: 10



19142
(91550-SH3-003)
Black Nylon

Pillar Garnish, Side And
Trunk Lining
Push-Type Retainer
Head Diameter: 15mm
Stem Length: 13mm
Fits Into 7mm Square Hole
Civic, Accord Wagon
& Del Sol
1993-On

UNIT PACKAGE: 5



14698
(90688-SB0-003)
Black Nylon

Push-Type
Retainer
Head Dia: 18mm
Stem Length: 11mm
Fits Into 6mm Hole

UNIT PACKAGE: 25



17350
(91516-SK7-013)
Black Nylon

Splash Shield
Push-Type Retainer
Phillips Drive
Head Dia: 20mm
Stem Length: 15mm
Fits Into 8mm Hole
10mm Hex
Civic
1992-On

UNIT PACKAGE: 10



20352
(91561-S84-A00-M1)
Black Nylon

Rear Panel Assembly
Push-Type Retainer
Head Diameter: 16mm
Stem Length: 21mm
Fits Into 8mm Hole

UNIT PACKAGE: 10



17057
(90505-SM4-003)
Black Nylon

Push-Type Retainer
Head Dia: 18mm
Stem Length: 21mm
Fits Into 8mm Hole
Accord
1990-On

UNIT PACKAGE: 10



17144
(91504-SM4-000)
Black Nylon

Push-Type Retainer
Head Diameter: 20mm
Stem Length: 24mm
Fits Into 10mm Hole
Bumper Fascia
Accord
1990-On

UNIT PACKAGE: 10



19546
(91570-SK7-003ZF)
Black Nylon

Tailgate Lining Retainer
Head Dia.: 17mm
Stem Length: 16mm
Fits Into 7mm Square Hole
Prelude
1997 - On

UNIT PACKAGE: 10



16000
(Honda: 90675-SB3-003;
Mazda: FB01-56-964;
Nissan: 63876-95596)
Black Nylon

Push-Type Retainer
Head Dia: 20mm
Stem Length: 9mm
Fits Into 8mm Hole

UNIT PACKAGE: 25

19408

Same As 17144
Except for packing

UNIT PACKAGE: 50

HONDA CLIPS & FASTENERS

Sec. 22



18119
(91502-SP0-003)
Black Nylon

Front & Rear Bumper
Push-Type Retainer
Head Diameter: 20mm
Stem Length: 25mm
Fits Into 10mm Hole
Honda
1990-On

UNIT PACKAGE: 10



18512
(91512-SE0-003)
Gray Nylon

Windshield Washer Hose Clip
11mm Wide, 42mm Long
Holds 6.3mm (1/4") Hose
Accord
1986-On

UNIT PACKAGE: 15



16950
(90677-SE0-003)
Nylon

Hood Prop Rod Clip
Holds 8mm Prop Rod
Accord
1986-On

UNIT PACKAGE: 5



17143
(91502-SM4-000)
Black Nylon

Push-Type Retainer
Head Diameter: 20mm
Stem Length: 27mm
Fits Into 10mm Hole
Bumper Fascia
Accord
1990-On

UNIT PACKAGE: 10

19407

Same as 17143
Except for packing

UNIT PACKAGE: 50



16949
(90652-SB2-023)
Nylon

Windshield Washer
Hose Retainer
For 3mm (7/64") I.D.,
5mm (13/64") O.D. Hose
Fits Into 7mm (9/32")
Square Hole
Honda
1986-On

UNIT PACKAGE: 15



19730
(90654-SA4-003)
Natural Nylon

Wire Routing Clip
Holds 6mm Diameter Wire
Fits Into 7mm Hole
Civic
1998 - On

UNIT PACKAGE: 15



18454
(91604-SD2-013)
Nylon

Hood Prop Rod Grommet
Civic
1989-On

UNIT PACKAGE: 5



21170
(91591-SJ6-013)
Natural Nylon

Door Lock Rod Clip
Rod Size: 5mm
Fits Into 7mm Hole
Overall Height: 17mm
Acura TSX and Honda Accord,
Odyssey & Ridgeline
2003 - On

UNIT PACKAGE: 15

Not Actual Size



20432
(91504-SR3-003)
Black Nylon

Windshield Washer Hose Clip
15mm Wide, 66mm Long
Holds 6.3mm (1/4") Hose
Accord, Civic,
CR-V & Del Sol
1993 - On

UNIT PACKAGE: 10



14688
(91547-SE0-0030)
Nylon

Hood Prop Rod Clip
Holds 6mm Prop Rod
Snaps Into 7mm Hole

UNIT PACKAGE: 25



14687
(90677-671-0031)
Nylon

Hood Prop Rod Clip
Holds 8mm Prop Rod
Snaps Into 9mm x 9mm Hole

UNIT PACKAGE: 25



21388
(91558-SE3-003)
Black Nylon

Sliding Door Lock and
Hood & Fuel Door Release
Cable Clip
Maximum Cable Diameter: 5mm
Closed Height Position: 17mm
Acura and Honda Accord, Civic,
CR-V, Insight, Odyssey, Pilot,
Prelude & Ridgeline
1991 - On

UNIT PACKAGE: 25

Not Actual Size



14284

(Honda: 90669-671-0000,
90669-671-0030;
Toyota: 90463-10337)
Nylon

Cable Strap
Length: 110mm (5-5/16")
Max. Bundle Dia.: 23mm
Fits Into 6mm Hole
UNIT PACKAGE: 15



Not Actual Size

20380

(Not Supplied
By O.E.M.)
Black Nylon

Cable Strap
Length: 200mm (8")
5mm (3/16") Wide
Max. Bundle Dia: 44mm (1-3/4")
Fits Into 6.3mm (1/4") Hole
Import Cars

UNIT PACKAGE: 25



20570

(Honda: 75307-SN7-000;
Mini-Cooper: 07-13-0-702-715)
Black Nylon

Nylon Moulding Nut
With Brass Insert
M4-0.7 Thread
12mm Flange O.D.
10mm Hex
Height: 11mm
1994 - On

UNIT PACKAGE: 15



Not Actual Size

14298

(Honda: 90672-SA0-0030;
Mazda: 9928-91-053)
Nylon

Releasable Cable Strap
Overall Length: 140mm (5-1/2")
Max. Bundle Dia: 30mm
Fits Into 7mm Hole
UNIT PACKAGE: 25



17289

(60658-SB3-000)
Nylon

Cowl Screen Screw Cover
Head Dia: 17mm
Fits Into 12mm Hole
Civic
1984-On

UNIT PACKAGE: 25



13225

Plated

"U" Type Nut
4.2mm (#8) Screw Size
11mm Wide
16.5mm Long
Panel Range: .5mm-2.5mm
Center of Hole To Edge: 8mm

UNIT PACKAGE: 50

HYUNDAI



21038

(87719-3D000)
Natural Nylon

Body Side Moulding Clip
Small Head: 6mm x 14mm
Base Diameter: 14mm
Overall Height: 6mm
Elantra & Sonata
2004 - On

UNIT PACKAGE: 15



16470

(90212-SA5-003)
Zinc

M10-1.25
Hex Flange Nut
With Serrations
20mm Flange O.D.
14mm Hex
Class 10
Used On Honda
Exhaust Systems

UNIT PACKAGE: 25



20566

(87756-3D000)
White Nylon

Body Side Moulding Clip
With Sealer
Head Size: 14mm x 14mm
Stem Length: 10mm
M4.2 (#8) Screw Size
Elantra & Sonata
2002 - On

UNIT PACKAGE: 15

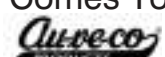
When The World Thinks Of
Body Hardware &
Specialty Fasteners,
Only One Name Comes To
Mind... 



20567
(87756-38000)
Black Nylon

Body Side Moulding Clip
With Sealer
Small Head Size: 8mm x 9mm
Large Head Size: 14mm x 18mm
Stem Length: 10mm
Elantra & Sonata
2002 - On
Kia Rio
2010 - On

UNIT PACKAGE: 15



21312
(87756-2G000)
Black Nylon

Body Side
Moulding Clip
With Sealer
Head Size: 8mm x 22mm
Stem Length: 10mm
Hyundai Sonata and
Kia Magentis & Optima
2006 - On

UNIT PACKAGE: 15



21064
(87758-35000)
Yellow Nylon

Rocker Moulding Clip
With Sealer
Top Head Size: 10mm x 11mm
Bottom Head Size: 14mm x 19mm
Stem Length: 10mm
Accent, Santa Fe & Tiburon
1995 - On

UNIT PACKAGE: 15



20568
(87758-3D000)
Yellow Nylon

Rocker Panel Clip
With Sealer
Top Head Size: 16mm x 20mm
Bottom Head Size: 14mm x 18mm
Stem Length: 10mm
Elantra & Sonata
2002 - On

UNIT PACKAGE: 15



21244
(87702-H1000)
White Nylon

Rocker Moulding Clip
With Sealer
Top Head Size: 11mm x 15.5mm
Bottom Head Diameter: 16mm
Stem Length: 12mm
Hyundai Genesis & Sonata
and Kia Sorrento
2009 - On

UNIT PACKAGE: 15



21136
(87756-2E000)
White Nylon

Moulding Clip
With Sealer
Top Head Size: 10mm x 12mm
Bottom Head Diameter:
14mm x 20mm
Stem Length: 10mm
Hyundai Entourage, Tucson &
Veracruz and Kia Optima,
Sedona, Spectra & Sportage
2005 - On

UNIT PACKAGE: 15



21321
(87758-3L000)
Blue Nylon

Moulding Clip
With Sealer
Top Head Size: 16mm x 18mm
Bottom Head Diameter:
18mm x 20mm
Stem Length: 15mm
Hyundai Azera & Genesis
2009 - On

UNIT PACKAGE: 15



21150
(14913-05010)
White Nylon

Front & Rear Bumper
and Fender
Nylon Nut
M4.8 (#10) Screw Size
Head Size: 12mm x 12mm
Stem Length: 11mm
Hyundai Elantra, Sonata,
XG300 & XG350 and
Kia Magentis & Optima
1992 - On

UNIT PACKAGE: 25



21069
(92351-37000)
Natural Nylon

Headlight Assembly Grommet
Head Diameter: 15mm
Stem Length: 8mm
Fits Into 10mm Hole
XG300/350
2001 - On
Kia
2000 - On

UNIT PACKAGE: 25



21356
(Hyundai: 87714-FD200;
Kia: 87756-1C000)
White Nylon

Body Side Moulding
Nylon Nut
M4.2 (#8) Screw Size
Head Size: 13mm x 13mm
Stem Length: 10mm
Hyundai Veracruz and Kia Rio
2009 - On

UNIT PACKAGE: 15



21068
(86848-22000)
Black Nylon

Fender Apron Nylon Nut
M4.8 (#10) Screw Size
Head Diameter: 16mm
Stem Length: 11mm
Fits Into 8.5mm Square Hole
Accent, Elantra,
Sonata & Tiburon
1995 - On

UNIT PACKAGE: 25



21232
(86910-21010)
Natural Nylon

Bumper Screw Grommet
With Sealer
M4.8 (#10) Screw Size
Head Diameter: 18mm
Stem Length: 21mm
Azera
2009 - On

UNIT PACKAGE: 15



20543
(81126-37010)
Black Nylon

Hood Insulation Retainer
Head Diameter: 26mm
Stem Diameter: 12mm
Stem Length: 14mm
Hyundai Elantra & Sonata
And Kia Optima
1995 - On

UNIT PACKAGE: 15



21066
(87758-37000)
White Nylon

Fender & Rocker Moulding
Nylon Nut With Sealer
M4.2 (#8) Screw Size
Head Size: 17mm x 17mm
Stem Length: 14mm
Hyundai Accent & Sonata
1999 - On
Kia
2001 - On

UNIT PACKAGE: 25



21381
(86438-4A100)
Black Nylon

Hood Seal Retainer
Head Size: 5mm x 13mm
Stem Diameter: 8mm
Stem Length: 11mm
Hyundai Elantra & Tucson
and Kia Forte & Sportage
2009 - On

UNIT PACKAGE: 50



21070
(Hyundai: 82315-38000
GM: 94530565)
White Nylon

Trim Panel Retainer;
Top Head Diameter: 13mm
Middle Head Diameter: 16mm
Bottom Head Diameter: 16mm
Stem Diameter: 9.5mm
Stem Length: 10mm
Chevrolet 2004 - On
Hyundai Accent, Santa Fe, Sonata
Tiburon & XG300/350 1999 - On
and Kia 2001 - On

UNIT PACKAGE: 25



21292
(87759-27000)
Yellow Nylon

Rocker Moulding Grommet
With Sealer
M4.2 (#8) Screw Size
Head Size: 17mm x 25mm
Stem Length: 16mm
Accent, Genesis, Santa Fe,
Sonata, Tiburon & Veracruz
1995 - On

UNIT PACKAGE: 15



21382
(86434-4A000)
Black Nylon

Hood Seal Retainer
Head Size: 6mm x 16mm
Stem Diameter: 8mm
Stem Length: 14mm
Hyundai Elantra, Sonata &
Tucson and Kia Sportage
2009 - On

UNIT PACKAGE: 50



21360
(85849-3B000)
White Nylon

Headliner & Trim Panel Retainer
Top Head Diameter: 13mm
Middle Head Diameter: 16mm
Bottom Head Diameter: 16mm
Stem Diameter: 10mm
Stem Length: 12mm
Hyundai
2001 - On

UNIT PACKAGE: 25



21188
(82315-27000)
Pink Nylon

Trim Panel Retainer
Top Head Diameter: 15mm
Middle Head Diameter: 16mm
Bottom Head Diameter: 18mm
Stem Diameter: 10mm
Stem Length: 12mm
Hyundai and Ki
2003 - On
UNIT PACKAGE: 15



21233
(86157-37000)
Black Nylon

Hood Mounting
Push-Type Retainer
Head Diameter: 10mm
Stem Length: 13mm
Fits Into 5mm Hole
Azera
2009 - On
UNIT PACKAGE: 15



21328
(86155-2H100)
Black Nylon

Cowl & Bumper
Push-Type Retainer
Head Diameter: 15mm
Stem Length: 10mm
Fits Into 7mm Hole
Hyundai Genesis & Veracruz
and Kia Rio
2009 - On
UNIT PACKAGE: 15



17632
(Mazda: B092-51-833;
Ford: MB-455-56143,
W705845-S300;
Hyundai: 86590-28000)
Black Nylon

Push-Type Retainer
Head Diameter: 18mm
Stem Length: 12mm
Fits Into 8mm Hole
Hyundai, Mazda & Ford Aspire
UNIT PACKAGE: 10



Not Actual Size

21355
(Not Available From O.E.M.)
Black Nylon

Cable Strap
Overall Length: 160mm (6-3/8")
Strap Width: 5mm (3/16")
Maximum Bundle Diameter:
36mm (1-13/32")
Fits Into 7mm Hole
Hyundai & Universal
UNIT PACKAGE: 25



21067
(86593-24000)
Stainless Steel

Bumper & Grille Retainer
Width: 13mm
Length: 30mm
Accent, Santa Fe & Sonata
1995 - On
UNIT PACKAGE: 25



21378
(86825-28000)
Black Nylon

Nylon "U" Nut
M6 (#14) Screw Size
Panel Size: Up To 1.5mm
Center Of Hole To Edge: 8mm
Hyundai Accent & Elantra
and Kia
1995 - On
UNIT PACKAGE: 25

INFINITI



20961
(Not Available From O.E.M.)
White Nylon

Drip Moulding Clip
With Sealer
Top Width: 25mm
Overall Height: 16mm
Fits Into 5mm Hole
Infiniti M45, I30 & G35
2005 - On
Nissan Altima, Maxima
& 350Z
2002 - On
UNIT PACKAGE: 15



20886
(76882-6P000)
White Nylon

Moulding Clip
Top Head Size: 8mm x 15mm
Bottom Head Dia: 15mm
Stem Length: 9mm
Infiniti
2005 - On
UNIT PACKAGE: 25



21243
(Not Available From O.E.M.)
White Nylon

Moulding Clip
Head Diameter: 15mm
Stem Length: 14mm
Fits Into 9mm Hole
Infiniti
2006 - On
UNIT PACKAGE: 15



21330

(Not Available From
O.E.M.)
White Nylon

Body Side
Moulding Clip
Head Size: 18mm x 25mm
Overall Length: 29mm
Infiniti
2008 - On

UNIT PACKAGE: 15



20764

(01281-00831)
Natural Nylon

Bumper, Fender & Light
Screw Grommet
M4.2 (#8) Screw Size
Head Diameter: 16mm
Stem Length: 10mm
Fits Into 9mm x 9mm Hole
Infiniti and Nissan 240SX,
Altima, Frontier, Maxima, Pathfinder,
Quest & Xterra
1989 - On

UNIT PACKAGE: 25



21324

(01281-00691)
Natural Nylon

Screw Grommet
With Sealer
M4.2 (#8) Screw Size
Head Diameter: 16mm
Stem Length: 20mm
Nissan 240SX, Altima, Frontier,
Maxima, Pathfinder & Titan and
Infiniti I30, I35 & Q45
1989 - On

UNIT PACKAGE: 15



21147

(85284-AD000)
White Nylon

Rear Bumper Clip
Height: 29mm
Width: 20mm
Length: 35mm
Infiniti G20, I30, I35, Q45 &
QX56 and Nissan 350Z, Altima,
Maxima & Murano
1999 - On

UNIT PACKAGE: 10



20673

(80874-0P000)
White Nylon

Cowl Vent Grommet
With Sealer
Head Size: 13mm x 13mm
Stem Length: 13mm
Use With Auveco 17633
Nissan & Infiniti
1997 - On

UNIT PACKAGE: 15



20604

(01281-00711)
Natural Nylon

Rocker Moulding
Screw Grommet
M4.2 (#8) & #10 (M4.8) Screw Size
Head Diameter: 20mm
Stem Length: 15mm
Nissan & Infiniti
1995 - On

UNIT PACKAGE: 10



21160

(85284-7S610)
Black Nylon

Rear Bumper Retainer
With Sealer
Head Diameter: 12mm
Stem Length: 21mm
Overall Length: 35mm
Infiniti QX56 and Nissan
Armada & Pathfinder
2004 - On

UNIT PACKAGE: 15



21425

(01281-01321)
Natural Nylon

Bumper Screw Grommet
M5.5 (#12) Screw Size
Overall Length: 22mm
Infiniti I30, I35 & Q45 and
Nissan Altima, Maxima & Quest
2009 - 1996

UNIT PACKAGE: 25



21111

(01281-00331)
Natural Nylon

Bumper, Rocker Panel
& Light Mounting
Screw Grommet
With Sealer
M6.3 (#14) Screw Size
Head Diameter: 20mm
Stem Length: 16mm
Fits Into 10mm Square Hole
Infiniti
1997 - On
Nissan
1996 - On

UNIT PACKAGE: 25

INFINITI CLIPS & FASTENERS

Sec. 22



20736
(01281-01081)
Natural Nylon

Front Bumper Nylon Nut
M4.8 (#10) Screw Size
Flange Diameter: 16mm
Overall Length: 22mm
Infiniti & Nissan
1997 - On

UNIT PACKAGE: 15



21229
(65810-K2000)
Black Nylon

Hood Sealer
Retaining Clip
Head Size: 6.4mm x 16mm
Stem Diameter: 3.5mm x 6mm
Stem Length: 10mm
Infiniti I30, I35, Q45 & QX4
and Nissan Maxima & Pathfinder
2004 - 1996

UNIT PACKAGE: 25



21519
(01553-01A50)
Black Nylon

Bumper & Trim Retainer
Head Diameter: 12mm
Stem Diameter: 6mm
Stem Length: 15mm
Infiniti FX35, G35, G37, M35,
M45 & Q45 and Nissan 350Z
& 370Z
1997 - On

UNIT PACKAGE: 25



19468
(65846-40F00)
Black Nylon

Hood Insulation Retainer
Head Diameter: 28mm
Stem Diameter: 6mm
Stem Length: 10mm
J30, M30 & Q45
1989-On

UNIT PACKAGE: 15



21414
(80999-VE000)
White Nylon

Trim Panel Retainer
With Sealer
Top Head Diameter: 13mm
Middle Head Diameter: 16mm
Bottom Head Diameter: 18mm
Stem Diameter: 9mm
Stem Length: 13mm
Infiniti and Nissan
1993 - On

UNIT PACKAGE: 25



20668
(01553-09791)
White Nylon

Trim Panel Retainer
Top Head Diameter: 13mm
Middle Head Diameter: 16mm
Bottom Head Diameter: 18mm
Stem Diameter: 9mm
Stem Length: 14mm
Nissan & Infiniti
1999 - On

UNIT PACKAGE: 15



21640
(84953-AU100)
Black Nylon

Door Trim Panel Retainer
With Sealer
Top Head Diameter: 13mm
Middle Head Diameter: 16mm
Bottom Head Diameter: 18mm
Stem Diameter: 9mm
Stem Length: 14mm
FX35, FX45, G35 & G37
2008 - 03

UNIT PACKAGE: 15



20669
(01553-07111)
Black Nylon

Trim Panel Retainer
Top Head Diameter: 13mm
Middle Head Diameter: 15mm
Bottom Head Diameter: 18mm
Stem Diameter: 9mm
Stem Length: 15mm
Nissan Altima and Infiniti
G35 & Q45
1997 - On

UNIT PACKAGE: 25



21633
(80850-89900)
White Nylon

Weather Retainer
Head Size: 6mm x 16mm
Stem Diameter: 6.5mm
Stem Length: 12mm
Infiniti I30, I35 & M45
and Nissan Maxima
2004 - 2000

UNIT PACKAGE: 25



21192
(01553-05323)
Black Nylon

Cowl, Bumper & Fender Liner
Push-Type Retainer
Head Diameter: 20mm
Stem Length: 12mm
Fits Into 8mm Hole
Infiniti FX35, FX45, G35
and Nissan
2003 - On

UNIT PACKAGE: 10

Sec. 22 INFINITI & ISUZU CLIPS & FASTENERS

INFINITI (Cont.)



20953
(11296-AG000)
Black Nylon

Front Bumper And
Radiator Support
Push-Type Retainer
Head Diameter: 20mm
Stem Length: 13mm
Fits Into 8mm Hole
Infiniti FX 35/45 and
Nissan Altima, Maxima
& Quest
2002 - On

UNIT PACKAGE: 25



21545
(01553-08231)
Black Nylon

Front & Rear Bumper
and Grille
Push-Type Retainer
Head Diameter: 20mm
Stem Length: 15mm
Fits Into 8mm Hole
Infiniti FX35, FX45 & Q45
and Nissan Murano, 240SX
& 350Z
1995 - On

UNIT PACKAGE: 25



21646
(80874-AX000)
Black Nylon

Hole Plug
Head Diameter: 25mm
Fits Into 18mm Hole
Infiniti EX35 and Nissan Juke
& Murano
2003 - On

UNIT PACKAGE: 25

INFINITI (Cont.)



21637
(01553-05131)
Black Nylon

Wheel Liner, Cowl Insulator
& Trim Flange Clip
Flange Diameter: 20mm
Hex: 10.5mm
Overall Height: 12.5mm
Infiniti EX35, FX35, FX50, G25,
G35, G37, J30, M35, M45 & Q45
and Nissan 370Z, Altima, Cube,
Frontier, GT-R, Juke, Leaf, Maxima,
Murano, NV, Pathfinder, Quest,
Rogue, Versa & Xterra
1993 - On

UNIT PACKAGE: 15



21664
(63848-9Y000)
Black Nylon

Fender Apron Clip
Width: 20mm
Width At Wings: 30mm
Overall Length: 30mm
Infiniti EX35, FX35, FX50, G35,
G37, M35, M37, M45 & M56
and Nissan Altima, Maxima,
Murano, Pathfinder, Quest & 370Z
2005 - On

UNIT PACKAGE: 10



21017
(76882-0M000)
White

Nylon "U" Nut
M4.8 (#10) Screw Size
Panel Range: Up To 1.5mm
Center of Hole To Edge: 8mm
Nissan & Infiniti
1995 - On

UNIT PACKAGE: 15

INFINITI (Cont.)



21459
(01241-00881)
Black Nylon

Nylon "U" Nut
With Captive Metal Hex Nut
M6 - 1.0 Thread
Center Of Hole To Edge: 14mm
Panel Range: Up To 4mm
Nissan Altima, Maxima & 240SX
and Infiniti I30
2001 - 1993

UNIT PACKAGE: 10

ISUZU



17195
(Isuzu: 8942180270)
Black Nylon

Grille Clip
13mm Wide 22mm Long
Ford Escort, Honda,
Isuzu, Mitsubishi & Plymouth Laser

UNIT PACKAGE: 25



17355
(GM: 94467458;
Isuzu: 8944674584)
Nylon

Windshield Reveal Moulding Clip
Isuzu and Geo Storm
1992-On

UNIT PACKAGE: 10

ISUZU (Cont.)	ISUZU (Cont.)	KIA (Cont.)
 <p>14739 (Isuzu: 8941340270; Toyota: 90189-05012) Natural Nylon</p> <p>#6 Screw Size 16mm Wide 12mm Long Snaps Into 6mm x 10mm Hole UNIT PACKAGE: 50</p>	 <p>17076 (GM: 94145515; Isuzu: 89414-55150)</p> <p>Inner Fender Shield & Bumper Fascia Retainer Head Dia: 18mm Stem Length: 23mm Stem Dia: 7mm Geo Storm & Isuzu 1990-On UNIT PACKAGE: 25</p>	 <p>21457 (86359-33500) White Nylon</p> <p>Front Bumper Moulding Clip Top Head Size: 10mm x 15mm Bottom Head Size: 16mm x 18mm Stem Length: 9mm Spectra 2009 - 04 UNIT PACKAGE: 25</p>
 <p>14269 (Isuzu: 8942264920; Mazda: 9927-40-825; Toyota: 67771-01010, 67771-12010) White Nylon</p> <p>Door Panel Retainer Top Head Diameter: 13mm Middle Head Diameter: 15.5mm Bottom Head Diameter: 18mm Stem Length: 14mm Overall Length: 20.5mm Stem Diameter: 9.5mm UNIT PACKAGE: 25</p>	 <p>20312 (GM: 15021761; Chry: 5027550AB) Yellow Nylon</p> <p>Hood Prop Rod Clip 7mm Rod Diameter Snaps Into 10mm Hole GM Cars & Trucks Chrysler PT Cruiser Isuzu Hombre 1990 - On UNIT PACKAGE: 10</p>	 <p>21363 (86591-25000) Black Nylon</p> <p>Bumper Cover Clip With Sealer Head Size: 25mm x 30mm Stem Length: 15mm Overall Length: 35mm Rio 2010 - On UNIT PACKAGE: 5</p>
 <p>14696 (Isuzu: 8942981190; Honda: 90684-SA5-003; Nissan: 10998-30880) Black Nylon</p> <p>Push-Type Retainer Head Diameter: 15mm Stem Length: 11mm Fits Into 6mm Hole UNIT PACKAGE: 25</p>	<h3>KIA</h3>	
 <p>14727 (Isuzu: 8942211500; GM: 94221150; Nissan: 63844-00100) Black Nylon</p> <p>Push-Type Retainer Head Size: 14mm x 22mm Stem Length: 9mm Fits Into 7mm Hole UNIT PACKAGE: 25</p>	 <p>21484 (87756-3E500) Red Nylon</p> <p>Wheel Flare & Body Side Moulding Clip With Sealer Top Head Size: 11mm x 13mm Bottom Head Size: 12mm x 20mm Stem Length: 10mm Forte Koup & Sorrento 2009 - On UNIT PACKAGE: 15</p>	 <p>21069 (92351-37000) Natural Nylon</p> <p>Headlight Assembly Grommet Head Diameter: 15mm Stem Length: 8mm Fits Into 10mm Hole Hyundai 2001 - On Kia Rio & Spectra 2000 - On UNIT PACKAGE: 25</p>



21371

(86699-2D000)
White Nylon

Front & Rear Bumper Cover
Nylon Nut

Head Size: 11mm x 11mm
Stem Length: 9mm
Overall Length: 13.5mm

Forte Koup
2010 - On

UNIT PACKAGE: 25



21066

(87758-37000)
White Nylon

Fender & Rocker Moulding
Nylon Nut With Sealer

M4.2 (#8) Screw Size
Head Size: 17mm x 17mm
Stem Length: 14mm
Hyundai 1999 - On
Kia Optima & Sorrento
2001 - On

UNIT PACKAGE: 25



20567

(87756-38000)
Black Nylon

Body Side Moulding Clip
With Sealer

Small Head Size: 8mm x 9mm
Large Head Size: 14mm x 18mm
Stem Length: 10mm
Elantra & Sonata
2002 - On
Kia Rio
2010 - On

UNIT PACKAGE: 15



21381

(86438-4A100)
Black Nylon

Hood Seal Retainer
Head Size: 5mm x 13mm
Stem Diameter: 8mm
Stem Length: 11mm
Hyundai Elantra & Tucson
and Kia Forte & Sportage
2009 - On

UNIT PACKAGE: 50



21382

(86434-4A000)
Black Nylon

Hood Sealer Retainer
Head Size: 6mm x 16mm
Stem Diameter: 8mm
Stem Length: 14mm
Hyundai Elantra, Sonata & Tucson
and Kia Sportage
2009 - On

UNIT PACKAGE: 50



21349

(85746-06000LX)
Gray Nylon

Headliner Retainer
Head Diameter: 18mm
Stem Diameter: 8mm
Stem Length: 16mm
Rio
2010 - On

UNIT PACKAGE: 25



21350

(85746-06000RU)
Tan Nylon

Headliner Retainer
Head Diameter: 18mm
Stem Diameter: 8mm
Stem Length: 16mm
Rio
2010 - On

UNIT PACKAGE: 25



20543

(81126-37010)
Black Nylon

Hood Insulation Retainer
Head Diameter: 26mm
Stem Diameter: 12mm
Stem Length: 14mm
Hyundai Elantra & Sonata
And Kia Optima
1995 - On

UNIT PACKAGE: 15



21070

(Hyundai: 82315-38000)
GM: 94530565)
White Nylon

Trim Panel Retainer
Top Head Diameter: 13mm
Middle Head Diameter: 16mm
Bottom Head Diameter: 16mm
Stem Diameter: 9.5mm
Stem Length: 10mm
Chevrolet 2004 - On
Hyundai 1999 - On
and Kia Optima, Rio &
Sorento 2001 - On

UNIT PACKAGE: 25



21188

(82315-27000)
Pink Nylon

Trim Panel Retainer
Top Head Diameter: 15mm
Middle Head Diameter: 16mm
Bottom Head Diameter: 18mm
Stem Diameter: 10mm
Stem Length: 12mm
Hyundai & Kia
2003 - On

UNIT PACKAGE: 15



21146
(0G032-50037-A)
Black Nylon

Bumper, Render, Grille, Interior & Exterior Trim and Pillar Push-Type Retainer
Head Diameter: 18mm
Stem Length: 12mm
Fits Into 8mm Hole
Amanti, Magentis, Optima, Rio, Sedona, Sephia, Sorrento, Spectra & Sportage
2000 – On

UNIT PACKAGE: 15



16858

(Kia: MNA01-56-145;
Mazda: NA01-56-145;
Nissan: 63844-01A00;
Ford: MNA01-56145,
NA01-56145)
Black Nylon

Inner Fender Push-Type Retainer
Head Dia: 20mm (25/32")
Stem Length: 18mm (23/32")
Fits Into 8mm (5/16") Hole
Kia, Ford, Mazda & Nissan

UNIT PACKAGE: 25



21372
(0K95A-68615)
Black Nylon

Cowl Trim Retainer
Flange Diameter: 25mm
Hex Size: 14mm
Overall Height: 10mm
Forte Koup
2010 – On

UNIT PACKAGE: 25



21378
(86825-28000)
Black Nylon

Nylon "U" Nut
M6 (#14) Screw Size
Panel Range: Up To 1.5mm
Center Of Hole To Edge: 8mm
Hyundai Accent & Elantra
and Kia
1995 – On

UNIT PACKAGE: 25

LAND ROVER



21657

(DYC101420)

White & Yellow Nylon

Moulding Clip
Top Head Diameter: 12.5mm
Middle Head Diameter: 15mm
Bottom Head Diameter: 15mm
Stem Diameter: 10.2mm
Stem Length: 8mm
Land Rover, Freelander
& Range Rover
2002 – On

UNIT PACKAGE: 25

LEXUS



21546

(90467-09204)

White Nylon

Rear Hatch Door Side Garnish
and Front Body Pillar Garnish
Moulding Clip
Overall Height: 14mm
Lexus GS 300, GS 400, GS 430,
GX 470, RX 330, RX 350, RX 400
& RX 450 and Toyota Camry,
Highlander, Prius & Sienna
1998 – On

UNIT PACKAGE: 25



21549
(90467-12080)
Pink Nylon

Door Trim, Instrument Panel,
Rear Deck Trim & Roof Garnish Trim
Moulding Clip
Overall Height: 21mm
Lexus ES 350, GX 460, RX 330 &
RX 450h and Toyota Avalon, Camry,
Corolla, Echo, FJ Cruiser,
Highlander, Matrix, Prius, RAV 4,
Sequoia, Sienna, Tacoma, Tundra,
Venza, Yaris & 4-Runner
2000 – On

UNIT PACKAGE: 25



19492

(75039-33040)

Front Fender
Moulding Clip
ES300
1991 - On

UNIT PACKAGE: 5

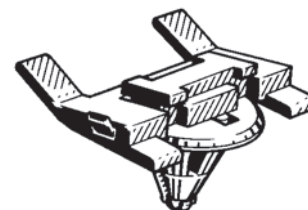

17989

(75049-33010)

Black Nylon

Side Moulding Retainer
Lexus
1990-On

UNIT PACKAGE: 5



19899
(75397-48010)
Red Nylon

Moulding Clip
ES300 & RX300
1999 - On

UNIT PACKAGE: 15



20877
(75392-60030,
75392-60031)
Gray Nylon

Rocker Panel Moulding Clip
Head Diameter: 18mm
Overall Length: 19mm
Lexus
2000 - On

UNIT PACKAGE: 15



21537
(90467-10190)
Black Nylon

Grille Clip
Top Head Size: 10mm x 10mm
Bottom Head Diameter: 15mm
Stem Diameter: 10mm
Stem Length: 10mm
RX 330, RX 350 & RX 400
1999 - On

UNIT PACKAGE: 25



20661
(75397-33010)
White Nylon

Body Side Moulding Clip
With Sealer
Head Size: 16mm x 20mm
Stem Length: 9mm
Lexus ES300
1997 - On

UNIT PACKAGE: 10



21314
(75393-60030)
Black Nylon

Moulding Clip
Head Diameter: 18mm
Overall Length: 24.5mm
Lexus
2000 - On

UNIT PACKAGE: 15



19120
(75039-33060)
Brown & White
Nylon

Door Lower Moulding Clip
ES300
1991-On

UNIT PACKAGE: 10



20605
(75397-48030)
Orange Nylon

Moulding Clip
With Sealer
Head Size: 15mm x 20mm
Stem Length: 15mm
Lexus
1999 - On

UNIT PACKAGE: 10



20875
(75394-60060)
Yellow Nylon

Fender Moulding Clip
With Sealer
Head Diameter: 18mm
Stem Length: 20mm
Lexus
2000 - On

UNIT PACKAGE: 10



19482
(75039-33010)
Brown & White Nylon

Front Door
Outside Moulding Clip
ES300
1991-On

UNIT PACKAGE: 5



19900
(75395-33030)
Pink Nylon

Moulding Clip
ES300 & RX300
1999 - On

UNIT PACKAGE: 15



20876
(75492-60030)
Gray Nylon

Fender Moulding Clip
With Sealer
Head Diameter: 18mm
Stem Length: 20mm
Lexus
2000 - On

UNIT PACKAGE: 10



19776
(75545-24030)
White Nylon

Windshield Moulding Clip
SC300 & SC400
1992 - On

UNIT PACKAGE: 10



21505
(75545-53011)
Blue Nylon

Windshield Moulding Clip
Width: 15mm
Length: 55mm
GX 460, IS250/350, IS F
2006 - On

UNIT PACKAGE: 5



21255
(75545-53010)
Blue Nylon

Windshield Clip
Width: 15mm
Length: 55mm
ES250 & IS250
2008 - On

UNIT PACKAGE: 10



20738
(53271-44010)
Black Nylon

Headlight Bracket Clip
25mm Wide, 40.5mm Long
Lexus IS-300 and Toyota
Camry & RAV 4
2001 - On

UNIT PACKAGE: 4



19783
(Ford: N811169-S,
W705550-S300;
Toyota: 90075-10801,
90189-06111)
White Nylon

Head Diameter: 13mm
Stem Length: 9mm
Fits Into 11mm Hole
Ford, Lexus & Toyota

UNIT PACKAGE: 50



21151
(90189-04059)
White Nylon

Rocker, Pillar, Floor &
Exterior Trim
Screw Grommet
M3.5 (#6) Screw Size
Head Size: 12mm x 18mm
Stem Length: 7mm
Lexus ES300, ES330, RX330,
RX400, SC300, SC400 and
Toyota Scion, Avalon & FJ Cruiser
1992 - On

UNIT PACKAGE: 25



21544
(90189-04102)
White Nylon

Screw Grommet
With Sealer
M3.2 (#6) Screw Size
Head Size: 10mm x 10mm
Stem Length: 15mm
Fits Into 7mm Square Hole
Lexus IS 250, IS 350 & IS F
and Toyota Highlander
2006 - On

UNIT PACKAGE: 25



19742
(90189-06104)
Natural Nylon

Fender Lining
Screw Grommet
#12 (M5.5) Screw Size
Head Diameter: 18mm
Stem Length: 15mm
Fits Into A 9mm Square Hole
Lexus IS300 And Toyota
Avalon, Camry & Sienna
1997 - On

UNIT PACKAGE: 15



21625
(90189-06145)
Black Nylon

Fender Lining
Screw Grommet
M5.5 (#12) Screw Size
Head Diameter: 16mm
Stem Length: 16mm
Fits Into 9mm x 9mm Hole
Lexus CT 200h and
Toyota Prius, Sequoia & T-100
1993 - On

UNIT PACKAGE: 15



21605
(90189-A0002)
Black Nylon

Screw Grommet
M5.5 (#12) Screw Size
Head Diameter: 20mm
Stem Length: 17mm
Fits Into 9mm x 9mm Hole
Lexus GX460, GX470 & LX570
and Toyota Avalon, Corolla,
FJ Cruiser, RAV4, Sienna,
Tacoma & 4-Runner
1995 - On

UNIT PACKAGE: 25



14273
(90189-06005)
White Nylon

Screw Grommet
#14 (1/4") or M6.3-1.81 Screw Size
Head Diameter: 18mm
Stem Length: 16mm
Fits Into 8mm x 8mm Hole
Lexus & Toyota

UNIT PACKAGE: 50



21015
(52535-50060,
52535-0E010)
Black Nylon

Front Bumper
Screw Grommet
M5.5 - M6 (#12) Screw Size
Head Size: 17mm x 30mm
Stem Length: 9mm
Lexus IS250, IS350,
RX330 & RX350 and
Toyota Camry, Highlander
& Tacoma
2001 - On

UNIT PACKAGE: 5



19535
(90467-07126)
Black Nylon

Cowl Vent Pin Retainer
Head Diameter: 16mm
Stem Length: 17mm
Use With Auveco 19534
Lexus ES300, Toyota Camry
& Tercel
1995 - On

UNIT PACKAGE: 10



14267
(90189-06013)
Black Nylon

Screw Grommet
#14 (1/4") or M6.3-1.81 Screw Size
Head Diameter: 20mm
Stem Length: 17mm
Fits Into 8mm x 8mm Hole
Lexus & Toyota

UNIT PACKAGE: 25



20758
(53879-58010)
Black Nylon

Front Fender & Bumper
Cover Clip
Width: 25mm
Length: 34mm
Use With Auveco 20757
Lexus and Toyota 4 Runner,
Highlander, Sienna & Solara
2000 - On

UNIT PACKAGE: 5



21084
(52599-0E010)
Black Nylon

Rear Bumper Grommet
With Sealer
Head Diameter: 21mm
Shoulder Diameter: 13mm
Stem Length: 27mm
RX 330, RX 350
& RX 400h
2004 - On

UNIT PACKAGE: 10



21583
(52535-30150)
White Nylon

Front & Rear Bumper
Screw Grommet
M5.5 (#12) Screw Size
Head Size: 17.5mm x 30mm
Stem Length: 10mm
Lexus ES300, 330, 350, LS430
& RX300 and Toyota Avalon,
Sequoia & Tundra
1999 - On

UNIT PACKAGE: 25



21358
(53879-50020)
Black Nylon

Bumper Cover Clip
Width: 35mm
Length: 25mm
Use With Auveco 21357
GS, IS & LS
2007 - On

UNIT PACKAGE: 10



20660
(90901-89004)
Yellow Nylon

Bumper Screw Grommet
With Sealer
M6.3 (#14) Screw Size
Head Size: 16.5mm x 18mm
Stem Length: 25mm
Lexus GS300 & GS400
1998 - On

UNIT PACKAGE: 10



19534
(90467-10152)
Natural Nylon

Cowl Vent Grommet
Flange Diameter: 18mm
Stem Length: 16mm
Fits Into 9mm Hole
Use With Auveco 19535
Lexus ES300, Toyota Camry
& Tercel
1995 - On

UNIT PACKAGE: 10



20757
(47749-58010)
Black Nylon

Front Fender & Bumper
Cover Pin Retainer
Head Diameter: 15mm
Stem Length: 25mm
Use With Auveco 20758
Lexus and Toyota 4 Runner,
Highlander, Sienna & Solara
2000 - On

UNIT PACKAGE: 10



21357
(47749-50090)
Black Nylon

Bumper Cover Pin Retainer
Head Diameter: 10mm
Stem Length: 24mm
Use With Auveco 21358
GS, IS & LS
2007 - On

UNIT PACKAGE: 15



20878
(90467-A0008)
Black Nylon

Bumper Cover Retainer
Head Diameter: 19mm
Stem Diameter: 7.5mm
Stem Length: 16mm
Lexus, Toyota & Scion
1995 - On

UNIT PACKAGE: 50



20874
(90467-07049-CO)
Black Nylon

Trim Panel Retainer
Head Diameter: 25mm
Stem Diameter: 7mm
Stem Length: 23mm
Lexus
2000 - On

UNIT PACKAGE: 25



18297
(Toyota: 90467-08004,
90467-08011)
(GM: 94842841, 94849113)
Black Nylon

Hood Seal Retaining Clip
Head Diameter: 13mm
Stem Length: 11mm
Fits Into 6mm Hole
Lexus, Toyota, Geo Prizm & Nova
1985 - On

UNIT PACKAGE: 50



21643
(90467-08101)
Black Nylon

Hood To Cowl Top Seal
Retaining Clip
Head Size: 7mm x 13mm
Stem Diameter: 7.5mm
Stem Length: 13mm
Lexus ES 300 and Toyota Camry,
Sequoia, Solara & Tundra
2006 - 1997

UNIT PACKAGE: 25



17990
(90467-09138)
Black Nylon

Retaining Clip
Head Size: 14mm x 15mm
Stem Length: 19mm
Fits Into 7mm Hole
Lexus 1990-On

UNIT PACKAGE: 5



21634
(90467-10186)
Black Nylon

Dash & Fender Apron
Seal Retainer
Head Diameter: 16.5mm
Stem Diameter: 9mm
Stem Length: 13mm
Lexus GX 460, GX 470 & LX 470
and Toyota 4 Runner, FJ Cruiser,
Land Cruiser, RAV4, Sequoia &
Tundra
1996 - On

UNIT PACKAGE: 25



19113
(90467-08124)
Black Nylon

Hood Insulation Retainer
Head Diameter: 25mm
Stem Diameter: 8mm
Stem Length: 12mm
Toyota Supra 1993-On
Lexus 1994-89

UNIT PACKAGE: 15



19729
(90467-09050)
Black Nylon

Hood Insulation Retainer
Head Diameter: 25mm
Stem Length: 10mm
Fits Into 7mm Hole
Lexus, Toyota Camry & Solara
1998-On

UNIT PACKAGE: 15



21627
(67868-30030)
Black Nylon

Door & Roof Rail Retainer
Head Diameter: 9mm
Stem Diameter: 5.3mm
Stem Length: 8mm
Lexus HS 250h, IS 250, IS 350,
RX 350 & 450h
2006 - On
Toyota Camry, Corolla, Corona
& Land Cruiser
1999 - 74

UNIT PACKAGE: 25



21548
(67869-20030)
Black Nylon

Weatherstrip Retainer
Head Diameter: 10mm
Stem Diameter: 6mm
Stem Length: 10mm
Lexus IS 300 & SC 430 and Toyota
Camry, Celica, Corolla, Highlander,
Matrix, MR-2, Prius, RAV-4, Scion,
Solara & Supra
1990 - On

UNIT PACKAGE: 25



21552

(90467-04034)
White Nylon

Weatherstrip Retainer
Top Head Size: 5mm x 15mm
Bottom Head Diameter: 9mm
Stem Diameter: 6.5mm
Stem Length: 4mm
Lexus CT 200h, HS 250h, IS F,
IS 250, IS 350, LS 460, LS 600h,
RX 350, RX 400h & RX 450h and
Toyota Avalon, Corolla, Highlander,
Matrix, Prius, RAV-4, Scion & Venza
2003 - On

UNIT PACKAGE: 25



17991

(90467-06092)
White Nylon

Retaining Clip
Head Size: 8mm x 17mm
Stem Length: 14mm
Fits Into 8mm Hole
Lexus
1990-On

UNIT PACKAGE: 10



21012

(75867-AA010)
Black Nylon

Rocker Panel &
Scuff Plate Retainer
Top Head Diameter: 13mm
Bottom Head Diameter: 18mm
Stem Diameter: 9.5mm
Stem Length: 14mm
Lexus ES300 & ES330
2002 - On
Toyota Avalon, Camry,
Scion & Solara
2004 - On

UNIT PACKAGE: 15



20473

(67771-12070)
White Nylon

Door Panel &
Rocker Moulding Retainer
With Sealer
Top Head Diameter: 13mm
Bottom Head Diameter: 18mm
Stem Diameter: 11mm
Stem Length: 14mm
Lexus SC300/400
Toyota Avalon & Corolla
1992 - On

UNIT PACKAGE: 15



20558

(62217-13010)
White Nylon

Garnish Moulding Retainer
Top Head Diameter: 13mm
Middle Head Diameter: 16mm
Bottom Head Diameter: 15mm
Stem Diameter: 10mm
Stem Length: 11mm
Lexus and Toyota Corolla,
Matrix & 4 Runner
2003 - On

UNIT PACKAGE: 25



20575

(67771-12080)
Yellow & White Nylon

Door Panel & Rocker
Moulding Retainer
Top Head Diameter: 13mm
Middle Head Diameter: 16mm
Bottom Head Diameter: 18mm
Stem Diameter: 10mm
Stem Length: 13mm
Overall Length: 20mm
Toyota & Lexus
1998 - On

UNIT PACKAGE: 15



20559

(GM: 88970345;
Toyota: 90467-10167)
Blue Nylon

Garnish Moulding Retainer
Top Head Diameter: 13mm
Middle Head Diameter: 16mm
Bottom Head Diameter: 18mm
Stem Diameter: 9mm x 9mm
Stem Length: 11mm
Pontiac Vibe, Lexus and Toyota
2000 - On

UNIT PACKAGE: 25



21102

(90467-A0005)
White Nylon

Door Trim Panel Retainer
With Sealer
Top Head Diameter: 13mm
Middle Head Diameter: 16mm
Bottom Head Diameter: 18mm
Stem Diameter: 8.5mm
Stem Length: 14mm
Lexus ES 350, GX 470, IS 250, IS
350, IS F, LS 460 & LS 600HL and
Toyota Camry, FJ Cruiser,
Highlander, RAV4 & 4-Runner
2001 - On

UNIT PACKAGE: 15



19257

(67771-12050)
Maroon Nylon

Front & Rear Door
Trim Board Retainer
Small Head Diameter: 13mm
Large Head Diameter: 18mm
Stem Diameter: 9mm
Stem Length: 14mm
Lexus and Toyota Celica,
Corolla & Previa
1990-On

UNIT PACKAGE: 15



17439
(90467-09093)
Black Nylon

Bumper Cover
Push-Type Retainer
Head Diameter: 15mm
Stem Length: 27mm
Fits Into 9mm Hole
LS-400

UNIT PACKAGE: 10



17988
(90467-09143)
Black Nylon

Push-Type Retainer
Head Diameter: 19mm
Stem Length: 26mm
Fits Into 9mm Hole
Lexus
1990-On

UNIT PACKAGE: 10



18270
(90467-07117)
Black Nylon

Push-Type Retainer
Head Dia: 17mm
Stem Length: 9mm
Fits Into 7mm Hole
Lexus
1990-On

UNIT PACKAGE: 10



21624
(90467-10206)
Black Nylon

Cowl Push-Type Retainer
Head Diameter: 16mm
Stem Length: 10mm
Fits Into 8mm Hole
Lexus ES 350, RX 350 &
RX 450h and Toyota Camry,
Sequoia, Tundra & Yaris
2006 - On

UNIT PACKAGE: 15



20577
(GM: 88970494;
Toyota: 90467-07168)
Black Nylon

Rocker Panel & Garnish Moulding
Push-Type Retainer
Head Diameter: 20mm
Stem Length: 8mm
Fits Into 7mm Hole
Pontiac Vibe 2004 - 2003
Lexus & Toyota
2000 - On

UNIT PACKAGE: 15



20869
(GM: 88970767;
Toyota: 90467-10183)
Black Nylon

Front Fender Liner
Push-Type Retainer
Head Diameter: 18mm
Stem Length: 7.5mm
Fits Into 7mm Hole
Lexus, Pontiac Vibe, and Toyota
Celica, Corolla,
Matrix & Solara
1999 - On

UNIT PACKAGE: 10



17992
(90467-07138)
Black Nylon

Push-Type Retainer
Head Diameter: 20mm
Stem Length: 12mm
Fits Into 7mm Hole
Lexus
1990-On

UNIT PACKAGE: 10



18939
(90467-09101)
Black Nylon

Bumper Cover
Push-Type Retainer
Head Diameter: 18mm
Stem Length: 23mm
Fits Into 9mm Hole
ES300
1993-On

UNIT PACKAGE: 25



19219
(90467-09096)
Black Nylon

Front Bumper
Push-Type Retainer
Head Diameter: 15mm
Stem Length: 27mm
Fits Into 9mm Hole
LS400 1993-On
Toyota Celica & Supra
1989-On

UNIT PACKAGE: 10



20349
(Toyota: 90467-08185;
Nissan: 01553-09611)
Black Nylon

Push-Type Retainer
Head Diameter: 18mm
Stem Length: 10mm
(Not Including The Pin)
Fits Into 8mm Hole
Lexus & Toyota
2002 - On
Nissan 1994 - On

UNIT PACKAGE: 15



21547

(90467-09185)
Black Nylon

Front Spoiler & Grille
Push-Type Retainer
Head Diameter: 18mm
Stem Length: 10mm
Fits Into 9mm Hole
Lexus HS 250h and Toyota Celica,
Sequoia, Sienna & 4-Runner
1994 - On

UNIT PACKAGE: 25



20955

(90467-07201)
Black Nylon

Engine Under Cover
Push-Type Retainer
Head Diameter: 20mm
Stem Length: 10mm
Fits Into 7mm Hole
Lexus ES300/330 and
Toyota Avalon, Camry & Solara
2002 - On

UNIT PACKAGE: 10



20470

(69293-12040)
Yellow Nylon

Door Lock Rod Clip
Rod Size: 5mm
Left (Driver) Side
Lexus ES 300 2001 - 97
Toyota Camry, Celica, Corolla,
Echo, Highlander, MR2, RAV4,
Tundra and 4-Runner
1994 - On

UNIT PACKAGE: 10



21201

(90467-07211)
Black Nylon

Bumper, Radiator Cover & Grille
Push-Type Retainer
Head Diameter: 19mm
Stem Length: 8mm
Fits Into 7mm Hole
Lexus IS & LS, Scion and Toyota
Avalon, Camry & Highlander
2005 - On

UNIT PACKAGE: 10



21596

(75867-06030)
Black Nylon

Rocker Panel
Push-Type Retainer
Head Diameter: 20mm
Stem Length: 16mm
Fits Into 8mm Hole
Toyota & Lexus
2007 - On

UNIT PACKAGE: 25



20534

(69293-12050)
Natural Nylon

Door Lock Rod Clip
Rod Size: 5mm
Fits Into 8.5mm Hole
Right (Passenger) Side
Lexus ES250, 300 & RX300
And Toyota Tacoma
1990 - On

UNIT PACKAGE: 10



21525

(53259-0E010)
Black Nylon

Front Inner Structure
Push-Type Retainer
Head Diameter: 19mm
Stem Length: 9mm
Fits Into 7mm Hole
Lexus EX 350, IS 250, IS 350,
RX 330 RX350 & RX 400h
2004 - On

UNIT PACKAGE: 15



20469

(69293-12030)
Natural Nylon

Door Lock Rod Clip
Rod Size: 5mm
Right (Passenger) Side
Lexus ES 300 2001 - 97
Toyota Camry, Celica, Corolla,
Echo, Highlander, MR2, RAV4,
Tundra and 4-Runner
1994 - On

UNIT PACKAGE: 10



20535

(69293-12060)
Yellow Nylon

Door Lock Rod Clip
Rod Size: 5mm
Fits Into 8.5mm Hole
Left (Driver) Side
Lexus ES250, 300 & RX300
And Toyota Tacoma
1990 - On

UNIT PACKAGE: 10

Lexus (Cont.)	Lexus (Cont.)	MAZDA
 <p>21336 (69293-30030) Natural Nylon</p> <p>Door Lock Rod Clip Rod Size: 5mm Fits Into 8mm Hole Overall Height: 20mm Toyota & Lexus 1993 - On</p> <p>UNIT PACKAGE: 10</p>	 <p>17993 (90179-05060) Black Nylon</p> <p>Nylon "U" Nut #10 Screw Size 18mm Wide, 27mm Long Panel Range: Up To 3mm Center Of Hole To Edge: 14mm Lexus 1990-On</p> <p>UNIT PACKAGE: 10</p>	 <p>16555 (GJ21-51-036)</p> <p>Headlight Adjusting Spring</p> <p>UNIT PACKAGE: 10</p>
<p>Not Actual Size</p>  <p>20380 (Not Supplied By O.E.M.) Black Nylon</p> <p>Cable Strap Length: 200mm (8") Max. Bundle Dia: 44mm (1-3/4") Fits Into 6.3mm (1/4") Hole Import Cars</p> <p>UNIT PACKAGE: 25</p>	 <p>21359 (53879-17020) Black Nylon</p> <p>Bumper & Fender Apron Nylon "U" Nut M4.8 (#10) Screw Size Panel Range: Up To 2mm Center Of Hole To Edge: 10mm Lexus GS, IS, LS & SC and Toyota Celica 2000 - On</p> <p>UNIT PACKAGE: 10</p>	 <p>19469 (G219-51-081) White Nylon</p> <p>Front Combination Headlight Pivot Holder MX-6, MPV & Protege 1995-On</p> <p>UNIT PACKAGE: 10</p>
 <p>21615 (90467-A0018, 90467-05081) Maroon Nylon</p> <p>Left & Right Front Bumper & Bumper Stay Nylon "U" Nut M6 (#14) Screw Size Panel Range: Up To 2mm Center Of Hole To Edge: 12mm Lexus and Toyota Avalon, Camry & Solara 2000 - On</p> <p>UNIT PACKAGE: 15</p>	 <p>20956 (90467-05114) Black Nylon</p> <p>Bumper & Fender Apron Nylon "U" Nut Screw Size: M5.5 (#12) Width: 20mm, Length: 36mm Panel Range: Up To 1mm Center Of Hole To Edge: 14mm Lexus & Toyota 2000 - On</p> <p>UNIT PACKAGE: 10</p>	 <p>20936 (Mazda: 9XG0-73-88X0; Ford: W707388-S300) Black Nylon</p> <p>Front Bumper Cover Moulding Clip Bottom Head Size: 18mm x 20mm Stem Length: 10mm Fits Into 8mm x 12mm Hole Mazda Tribute 2006 - 2001 Ford Escape 2001 - On</p> <p>UNIT PACKAGE: 10</p>
		 <p>19228 (NA01-50-101A) Nylon</p> <p>Bumper Clip Miata 1992-On</p> <p>UNIT PACKAGE: 10</p>



21561
(E11451W24)
White Nylon

Moulding Clip
Top Head Size: 10mm x 15mm
Bottom Head Diameter: 17mm
Stem Diameter: 13mm
Stem Length: 9mm
CX-7
2007 - ON

UNIT PACKAGE: 25



18882
(Ford: KA80-51-PR6;
Mazda: EA01-50-048)
Black Nylon

Body Side Lower
Wide Moulding Grommet
Ford Probe & Mazda MX6
1993-On

UNIT PACKAGE: 10



19450
(T001-50-M48B)
Natural Nylon

Rear Door Garnish Clip
Millenia
1995 - On

UNIT PACKAGE: 25



19451
(B173-50-852A)
Black Nylon

Cowl Panel Clip
Millenia
1995 - On

UNIT PACKAGE: 15



19755
(LB82-50-669A)
White Nylon

Door Belt
Moulding Clip
Width: 25mm
Length: 32mm
MPV
1998 - On

UNIT PACKAGE: 10

Bottom
View



Top
View



21171
(BP4L-51-SJ3)
Gray Nylon

Moulding Clip
With Sealer
Top Head Size: 14mm x 20mm
Bottom Head Diameter: 36.5mm
Stem Length: 10mm
3, 5, 6, CX-7, CX-9 & RX-8
2004 - On

UNIT PACKAGE: 10

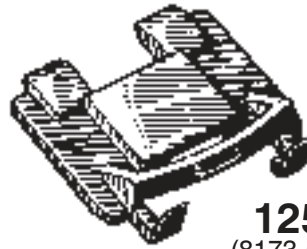

12589
(8173-50-931)
Nylon

Windshield Moulding Clip
28mm Wide; 26mm Long

UNIT PACKAGE: 15



15469
Nylon

Windshield Reveal Moulding Clip
15mm Wide, 25.5mm Long
Nissan & Mazda

UNIT PACKAGE: 25



14719
(H001-50-609)
Nylon

Windshield Moulding Clip
25mm Wide
10mm Long

UNIT PACKAGE: 25



17290
(B092-50-609)
Nylon

Rear Window Moulding Clip
MX6 1988-On
Ford Probe 1988-On
Mercury Tracer 1987-On

UNIT PACKAGE: 15



12591

(1243-50-609)
Nylon

Windshield Moulding Clip
28.5mm Wide
Clip Length: 14.5mm
Arm Length: 22.5mm
UNIT PACKAGE: 25



19648

(HG30-50-6B9A)
Brown Nylon

Windshield Clip
Width: 13mm
Length: 49mm
Height: 11mm
929 & Millenia
1992 - On

UNIT PACKAGE: 10



19452

(JOY1-50-619C)
White Nylon

Rear Window
Moulding Clip
With Adhesive Backing
Millenia
1995 - On

UNIT PACKAGE: 10

For The Most Up-To-Date
Information
On New Items Available
From Auveco,
refer to the
"Hot New Items" Section of the
Auveco Web Site
(www.auveco.com)



20958

(GJ6A-68-162)
White Nylon

Windshield Garnish
Moulding Retainer
Top Head Size:
10mm x 13mm
Bottom Head
Diameter: 16mm
Stem Length: 33mm
Fits Into 10mm Hole
3,5 & RX8
2004 - On

UNIT PACKAGE: 10



20960

(GM9E-63-938A)
White Nylon

Windshield Moulding Clip
Head Size:
17mm x 20mm
Stem Length: 21mm
Fits Into 8mm Hole
Mazda 6
2003 - On

UNIT PACKAGE: 10



20957

(G6JA-50-0Z5)
Natural Nylon

Front Bumper
Screw Grommet
Screw Size: M4.2 (#8)
Head Size:
23mm x 24mm
Stem Length: 14mm
Miata, MPV, RX8
3, 5 & 6
2000 - On

UNIT PACKAGE: 15



20984

(BC1M-50-0Z5)
Natural Nylon

Front Bumper
Screw Grommet
M4.2 (#8) Screw Size
Head Size:
24mm x 28mm
Stem Length: 14mm
323, 626, Miata
MPV & Protégé
1995 - On

UNIT PACKAGE: 10



19831

(LA01-50-6A8A)
White Nylon

Window Screw Grommet
With Sealer Gasket
#6 Screw Size
MPV
1998 - On

UNIT PACKAGE: 10



13930

(Nissan: 96706-B0700;
Mazda: 9991-00-412)
Natural Nylon

#8 Screw Size
9.5mm Wide
9.5mm Long
Snaps Into 7mm x 7mm Hole

UNIT PACKAGE: 50



14255

(Mitsubishi: MS-480001;
Honda: 75522-611-0000;
Mazda: 9991-00-412)
Black Nylon

#8 Screw Size
9.5mm Wide
9.5mm Long
Snaps Into 7mm x 7mm Hole

UNIT PACKAGE: 50



14274

(Mazda: 9991-00-601;
Honda: 75521-611-0000;
Nissan: 96706-P0105;
Toyota: 90189-06010)
Natural Nylon

#10 Screw Size
13mm Wide; 13mm Long
Snaps Into 8.5mm x 8.5mm Hole

UNIT PACKAGE: 25



14357

(9991-00-501)
Natural Nylon

#10 Screw Size
12mm Wide
12mm Long
Snaps Into 8mm x 8mm Hole

UNIT PACKAGE: 25



14313

(Mazda: 9991-00-503)
Honda: 90662-671-0030;
Nissan: 62698-V7000,
68425-H5000)
Natural Nylon

#10 Screw Size
17mm Wide
17mm Long
Snaps Into 8mm x 8.5mm Hole

UNIT PACKAGE: 25



14364

(9991-00-403)
Natural Nylon

#8 Screw Size
Head Diameter: 13mm
Fits Into 7mm x 7mm Hole

UNIT PACKAGE: 25



14366

(9991-00-402)
Natural Nylon

Screw Grommet
#6 Screw Size
9.5mm Wide, 9.5mm Long
Stem Length: 16mm
Fits Into 7mm x 7mm Hole
Also for Nissan/Datsun

UNIT PACKAGE: 50



14695

(Mazda: H001-50-841;
Honda: 90661-SC7-0030;
Mitsubishi: MS-480012;
Nissan: 01651-00481,
74798-S9000;
Toyota: 90189-06042)
White Nylon

Screw Grommet
#8 Screw Size
Head Diameter: 16mm
Stem Length: 17mm
Fits Into 8mm x 8mm Hole

UNIT PACKAGE: 25



19832

(LB84-68-AD5)
White Nylon

Door Trim
Screw Grommet
With Sealer Gasket
#6 Screw Size

Head Size: 10mm x 10mm
Stem Length: 15mm
MPV
1998 - On

UNIT PACKAGE: 10



21413

(GS3L-68-615)
Black Nylon

Cowl Trim Grommet
Head Diameter: 25mm
Stem Length: 22mm
6 GT
2010 - On

UNIT PACKAGE: 10



20579

(FD02-50-798)
Black Nylon

Cowl Vent Grommet
With Sealer
M4.2 (#8) Screw Size
Head Size: 12mm x 22mm
Stem Length: 13mm
323, 626, Millenia & MX6
1995 - On

UNIT PACKAGE: 10



19748

(KA78-50-AF4)
Black Nylon

Splash Shield
Screw Grommet
#12 (M5.5) Screw Size
Head Diameter: 18mm x 20mm
Stem Length: 15mm
626
1998 - On

UNIT PACKAGE: 10



19833

(H260-50-6K8)
White Nylon

Cowl Screw Grommet
With Sealer Gasket
#8 (M4.2 - 1.41) Screw Size
Head Size: 16mm x 22mm
Stem Length: 20mm
MPV
1998 - On

UNIT PACKAGE: 10



19743

(GJ21-58-502A)
Natural Nylon

Window Moulding
Screw Grommet
#12 (M5.5) Screw Size
18mm Wide, 22mm Long
Snaps Into 11mm Hole
626
1998-On

UNIT PACKAGE: 15

When The World Thinks Of
Body Hardware &
Specialty Fasteners,
Only One Name Comes To
Mind... 



20463

(S084-58-502)
Natural Nylon

Door Glass
Screw Grommet
#12 Screw Size
18mm Wide, 32mm Long
Stem Length: 10mm
626
2000 - ON

UNIT PACKAGE: 10



19753

(GA2A-56-399A)
Black Nylon

Front Fender
Plate Seal Clip
Head Diameter: 18mm
Stem Length: 26mm
626
1998 - On

UNIT PACKAGE: 10



17451

(H001-68-719B)
Natural Nylon

Rocker Scuff Plate Retainer
Ford Probe and
Mazda MX6
1988-On

UNIT PACKAGE: 25



19138

(Ford: F1CZ-5802316A;
Mazda: BW0A-50-792)
Gray Nylon

Cowl Top Vent Grille Retainer
Ford Escort & Tracer
and Mazda
1991 - On

UNIT PACKAGE: 15



17551

(GJ21-50-H81)
Natural Nylon

Cowl Screen Grommet
Ford Probe and
Mazda 626 & MX6
1988-On

UNIT PACKAGE: 25



17552

(GJ21-50-H82)
Natural Nylon

Cowl Screen Grommet
Ford Probe and
Mazda 626 & MX6
1988-On

UNIT PACKAGE: 25



17553

(KA01-50-H16)
Green Nylon

Rear Hatch Grommet
Ford Probe and
Mazda MX 6 1988-On
Use With 17554

UNIT PACKAGE: 25



17554

(KA01-50-H15A)
Black Nylon

Rear Hatch Retainer
Ford Probe and
Mazda MX6 1988-On
Use With 17553

UNIT PACKAGE: 25



14367

(9924-90-512B)
Black Nylon

Retainer
Head Diameter: 12mm
Stem Length: 10mm
Snaps Into 4mm Hole
Panel Thickness: 2mm

UNIT PACKAGE: 50



21307

(BP4K-58-762)
Black Nylon

Weatherstrip Retaining Clip
Head Diameter: 9mm
Stem Diameter: 5.5mm
Stem Length: 7mm
Mazda
2007 - On

UNIT PACKAGE: 25



21520

(J001-56-741)
Black Nylon

Weatherstrip Retaining Clip
Head Diameter: 14mm
Stem Diameter: 6.5mm
Stem Length: 10mm
CX-7, Millenia, MPV, 3, 6 & 626
1995 - On

UNIT PACKAGE: 25



18458

(Ford: F1CZ-16774-A;
Mazda: B455-56-741)
Black Nylon

Hood Insulation Retaining Clip
Head Diameter: 14mm
Stem Length: 10mm
Fits Into 6mm Hole
Ford Probe & Mazda MX6
1992-88

UNIT PACKAGE: 25



14349

(Mazda: 9926-40-543A;
Nissan: 01553-00291)
Black Nylon

Retaining Clip
Head Dia: 11mm
Stem Length: 15mm
Fits Into 5.5mm Hole
Panel Thickness: 5mm

UNIT PACKAGE: 50



18271

(9926-40-531B)
Black Nylon

Hood Insulation Retainer
Head Diameter: 14mm
Stem Diameter: 6mm
Stem Length: 15mm

UNIT PACKAGE: 25



17453

(B003-68-865-96)
Gray Nylon

Rear Compartment
Interior Trim Retainer
Head Diameter: 15mm
Stem Length: 14mm
Stem Diameter: 6.5mm
Ford Probe and
Mazda MX6
1988-On

UNIT PACKAGE: 50



16777

(Mazda: B001-68-302-00;
Toyota: 90950-01248)
Black Nylon

Retaining Clip
Head Dia: 15mm
Stem Length: 15mm
Panel Thickness: 2mm
Fits Into 8mm Hole

UNIT PACKAGE: 25



14380

(8133-50-022)
Black Nylon

Retaining Clip
Head Diameter: 18mm
Stem Length: 18mm
Snaps Into 8mm Hole
Panel Thickness: 7mm

UNIT PACKAGE: 25



14709

(Mazda:
G030-68-885-B-38;
Ford: F22Z-16774-A,
GA2A-56694)
Black Nylon

Hood Insulation Retainer
Head Diameter: 20mm
Stem Length: 9mm
Fits Into 6mm Hole

UNIT PACKAGE: 25



21661

(TD11-56-694)
Black Nylon

Hood Insulation Retainer
Head Diameter: 20mm
Stem Diameter: 7mm
Stem Length: 10mm
3, 5, 6, CX7, CX9,
MX-5 Miata & RX8
2004 - On

UNIT PACKAGE: 25



21560

(G032-68-865A-00)
Black Nylon

Trunk & Carpet Retainer
Head Diameter: 20mm
Stem Diameter: 7mm
Stem Length: 15mm
B2000, B2600, CX-7, CX-9,
Miata, Millenia, MX-3, MX-5,
MX-6, Protege, RX-7, RX-8,
3, 5, 6, 626 & 929
1987 - On

UNIT PACKAGE: 25



18692

(Mazda: G031-58-762;
Toyota: 67867-89103,
97868-89101)
Natural Nylon

Weatherstrip Retainer
Head Size: 5mm x 15mm
Stem Length: 10mm
Fits Into 5mm Hole
Toyota 4-Runner 1989-83
Mazda 1996-On

UNIT PACKAGE: 50



20460

(G043-50-742)
Black Nylon

Cowl Panel Retainer
With Sealer
Top Head Dia.: 14mm
Bottom Head Dia.: 18mm
Stem Dia.: 9mm
Stem Length: 13mm
626
2000 - On

UNIT PACKAGE: 10



20932

(G18K-51-SJ3)
White Nylon

Door Trim Panel Retainer
With Sealer
Top Head Diameter: 14mm
Bottom Head Diameter: 18mm
Stem Diameter: 12mm
Stem Length: 14mm
3, 5, 6, CX-7
Miata & Protégé
2001 - On

UNIT PACKAGE: 10



20983
(GJ6R-68-ABX)
White Nylon

Trim Panel Retainer
With Sealer
Top Head Diameter: 13mm
Middle Head Diameter: 16mm
Bottom Head Diameter: 18mm
Stem Diameter: 9mm
Stem Length: 13mm
3, 5, 6, Miata & RX-8
2003 - On

UNIT PACKAGE: 15



14269
(Mazda: 9927-40-825;
Isuzu: 8942264920;
Toyota: 67771-01010,
67771-12010)
White Nylon

Door Panel Retainer
Top Head Diameter: 13mm
Middle Head Dia.: 15.5mm
Bottom Head Diameter: 18mm
Stem Diameter: 9.5mm
Stem Length: 14mm
Overall Length: 20.5mm

UNIT PACKAGE: 25



18824
(G350-68-AB1)
White Nylon

Trim Panel Retainer
Top Head Diameter: 13mm
Bottom Head Diameter: 15mm
Stem Length: 9.5mm
Fits Into 9mm Hole
626, MX6, Millenia, MX3,
929, Protege & MPV
and Ford Probe
1992-On

UNIT PACKAGE: 50



21412
(TD12-51-SJ3A)
Gray Nylon

Rocker Moulding Retainer
With Sealer
Top Head Diameter: 14mm
Bottom Head Diameter: 18.5mm
Stem Diameter: 12mm
Stem Length: 13mm
6 GT
2010 - On

UNIT PACKAGE: 15



20459
(GA2A-68-AB1A)
Black Nylon

Trim Panel Retainer
Top Head Dia.: 15mm
Bottom Head Dia.: 16mm
Stem Dia.: 9mm
Stem Length: 10mm
626
2000 - On

UNIT PACKAGE: 10



14363
(9927-40-821)
Nylon

Door Panel Retainer
Bottom Head Diameter: 17mm
Stem Length: 14mm
Overall Length: 20mm
Fits Into 8mm Hole

UNIT PACKAGE: 25



16778
(Mazda: 9927-40-822;
Toyota: 62581-14020)
Natural Nylon

Trim Panel Retainer
Small Head Dia: 14mm
Large Head Dia: 18mm
Stem Length: 14mm
Fits Into 8mm Hole

UNIT PACKAGE: 25



19481
(GA2A-58-762)
Blue Nylon

Weatherstrip Retainer
Head Size: 5mm x 15mm
Stem Length: 8mm
Fits Into 6mm Hole
Front & Rear Door
and Hood Weatherstrip
626 & Millenia
1995 - On

UNIT PACKAGE: 50



21663
(EA01-50-037)
Black Nylon

Push-Type Retainer
Head Diameter: 10mm
Stem Length: 9mm
Fits Into 5mm Hole
2, 3, CX7, CX9, MX-3,
MX-5 Miata & RX8
1992 - On

UNIT PACKAGE: 15



21662
(S51S-51-833)
Black Nylon

Push-Type Retainer
Head Diameter: 11mm
Stem Length: 11mm
Fits Into 7mm Hole
3, MX-5 Miata & RX8
2004 - On

UNIT PACKAGE: 15



14697
(Mazda: N304-13-356-A;
GM: 94198687;
Honda: 90657-SA6-0030)
Black Nylon

Push-Type Retainer
Head Diameter: 14mm
Stem Length: 11mm
Fits Into 7mm Hole

UNIT PACKAGE: 25



17478

(B101-68-252-00)
Black Nylon

Interior Trim
Push-Type Retainer
Head Diameter: 14mm
Stem Length: 16mm
Fits Into 6mm Hole
Ford Probe and
Mazda MX6
1988-On

UNIT PACKAGE: 25



20465

(UB39-45-919)
Black Nylon

Front & Rear Fender
Push-Type Retainer
Head Diameter: 18mm
Stem Length: 9mm
Fits Into 8mm Hole
626
2000 - On

UNIT PACKAGE: 10



17632

(Mazda: B092-51-833;
Ford: MB-455-56143,
W705845-S300;
Hyundai: 86590-28000)
Black Nylon

Push-Type Retainer
Head Diameter: 18mm
Stem Length: 12mm
Fits Into 8mm Hole
Mazda, Hyundai & Ford Aspire

UNIT PACKAGE: 10



20923

(Ford: 3M8Z-1502316-A;
Mazda: GJ6E-50-715A)
Black Nylon

Cowl Vent
Push-Type Retainer
Head Size: 8.5mm x 12mm
Stem Length: 9mm
Fits Into 5mm Hole
Ford Fusion, Milan & Zephyr
2006 - On
Mazda 5 & 6
2003 - On

UNIT PACKAGE: 15



21024

(Ford: 5R3Z-54310D12-AAA,
6E5Z-7850980-AAA; Mazda:
GJ21-68-885B-02)
Black Nylon

Trim Panel
Push-Type Retainer
Head Diameter: 18mm
Stem Length: 10mm
Fits Into 6mm Hole
Ford Fusion & Mustang
2005 - On
Mazda 1992 - On

UNIT PACKAGE: 15



18206

(GJ21-68885-B69)
Gray Nylon

Push-Type Retainer
Head Diameter: 18mm
Stem Length: 12mm
Fits Into 6mm Hole
Ford Probe &
Mazda MX6
1989-On

UNIT PACKAGE: 25



14260

(Mazda: 9926-50-625;
Toyota: 90467-06017)
Black Nylon

Push-Type
Retainer
Head Diameter: 15mm
Stem Length: 12mm
Fits Into 7mm Hole

UNIT PACKAGE: 15



21110

(B100-68-8550)
Black Nylon

Rear Light Access Door
Push-Type Retainer
Head Diameter: 18mm
Stem Length: 12mm
Fits Into 8.5mm Hole
323

1986 - On

UNIT PACKAGE: 15



19306

(GA5R-56-392)
Black Nylon

Shroud Seal Board
Push-Type Retainer
Head Diameter: 16mm
Stem Length: 12mm
Fits Into 6mm Hole
626

1994-On

UNIT PACKAGE: 10



19747

(UB39-50-795)
Black Nylon

Stone Guard
Push-Type Retainer
Head Diameter: 18mm
Stem Length: 10mm
Fits Into 8mm Hole
MPV
1998-On

UNIT PACKAGE: 10



19416

(Toyota: 90467-09139)
Black Nylon

Bumper Cover &
Wheel Housing
Push-Type Retainer
Head Diameter: 18mm
Stem Length: 15mm
Fits Into 9mm Hole
Honda, Mazda 626 &
Toyota Corolla
1992-On

UNIT PACKAGE: 15



20755
(GD7A-50-EA1)
Black Nylon

Bumper Cover & Grille
Push-Type Retainer
Head Diameter: 19.5mm
Stem Length: 15mm
Fits Into 10mm Hole
Mazda
1999 - On

UNIT PACKAGE: 10



14369
(1395-68-676,
9926-50-635)
Black Nylon

Push-Type Retainer
Head Diameter: 20mm
Stem Length: 9mm
Fits Into 6mm Hole

UNIT PACKAGE: 15



16000
(Honda:
90675-SB3-003;
Mazda: FB01-56-964;
Nissan:
63876-95596)
Black Nylon

Push-Type Retainer
Head Dia: 20mm
Stem Length: 9mm
Fits Into 8mm Hole

UNIT PACKAGE: 25



19315
(BC1D-56-145)
Black Nylon

Mud Guard Push-Type Retainer
Head Diameter: 20mm
Stem Length: (Exc. Pin): 9mm
Fits Into 8mm Hole
Protege
1996-On

UNIT PACKAGE: 15



16858
(Mazda: NA01-56-145;
Kia: MNA01-56-145;
Nissan: 63844-01A00;
Ford: MNA01-56145,
NA01-56145)
Black Nylon

Inner Fender Push-Type Retainer
Head Dia: 20mm (25/32")
Stem Length: 18mm (23/32")
Fits Into 8mm (5/16") Hole
Mazda, Kia, Ford & Nissan

UNIT PACKAGE: 25



21119
(B100-68-675-69)
Black Nylon

Push-Type Retainer
Head Diameter: 20mm
Stem Length: 19mm
Fits Into 6mm Hole
Mazda MX6 and
Ford Probe
1988 - On

UNIT PACKAGE: 15



17450
(Ford: E8B2-17C756C;
Mazda: BF67-50-235)
Black Nylon

Bumper Cover Retainer
Head Size: 20mm x 30mm
Stem Length: 11mm
Fits Into 10mm Hole
Ford Festiva 1988-On
Mazda 323 1986-On

UNIT PACKAGE: 10



15366
(Ford: E7GZ-17A904-B;
Mazda: BF67-50-033)
Gray Nylon

Bumper Retainer
Head Size: 20mm x 30mm
Stem Length: 11mm
Fits Into 10mm Hole
Mazda and
Mercury Tracer 1987-On

UNIT PACKAGE: 10



16843
(Mazda: BF82-50-233;
Nissan: 01553-01393)
Black Nylon

Bumper Cover Retainer
Head Size: 20mm x 30mm
Stem Length: 18mm
Fits Into 10mm Hole

UNIT PACKAGE: 10



17060
(Ford: E92Z-17C756C;
Mazda: GJ21-50-034)
Black Nylon

Bumper Cover Retainer
Head Size: 20mm x 30mm
Stem Length: 20mm
Fits Into 10mm Hole
Ford Probe & Mazda MX6
1989-On

UNIT PACKAGE: 10



14378

(9927-70-901)
Nylon

Tube/Cable
Routing Clip
For Holding Multiple
Cables or Tubes
Diameter: 8mm
Fits Into 6mm Hole
UNIT PACKAGE: 25



20195

Pink Door Lock Pawl
Left-Hand Side
Ford Continental, Contour,
Explorer, Mountaineer, Mystique,
Ranger, Sable
& Taurus And Mazda Truck
1996 - On

UNIT PACKAGE: 1



14359

(9927-80-405)
Nylon

Rod End Clip
Holds 4mm Rods
Snaps Into 6mm Hole

UNIT PACKAGE: 25



14365

(9927-80-404)
Nylon

Rod End Clip
Holds 4mm Rods
Snaps Into 6mm
Hole

UNIT PACKAGE: 25



14376

(9928-90-753)
Nylon

Releasable
Cable Strap
Length: 110mm (4-3/8")
Max. Bundle
Diameter: 25mm
Fits Into 7mm Hole

UNIT PACKAGE: 15



Not Actual Size

21305

(Not Available From O.E.M.)
Natural Nylon

Push-Mount Cable Strap
Overall Length: 156mm (6-1/8")
Strap Width: 5mm (3/16")
Snaps Into 6.3mm (1/4") Hole
Maximum Bundle Diameter:
40mm (1-9/16")
European Makes & Universal

UNIT PACKAGE: 25



20153

White Door Lock Pawl
Right-Hand Side
Mazda Truck and Ford
Continental, Contour,
Explorer, Mountaineer, Mystique,
Ranger, Sable & Taurus
1996 - On

UNIT PACKAGE: 1



Not Actual Size

14298

(Mazda: 9928-91-053;
Honda: 90672-SA0-0030)
Nylon

Releasable Cable Strap
Overall Length: 140mm (5-1/2")
Max. Bundle
Diameter: 30mm
Fits Into 7mm Hole

UNIT PACKAGE: 25



20380

(Not Supplied By O.E.M.)
Black Nylon

Cable Strap
Length: 200mm (8")
5mm (3/16") Wide
Max. Bundle Dia: 44mm (1-3/4")
Fits Into 6.3mm (1/4") Hole
Import Cars

UNIT PACKAGE: 25

MAZDA (Cont.)



19754
(UB42-67-013)
Black Nylon

Wiring Harness
Routing Clip
MPV
1998 - On

UNIT PACKAGE: 15



17003

(Mazda: GJ21-50-049;
Ford: F32Z-17C756-S)

Bumper Cover Retainer
Front & Rear Bumpers
Mazda & Ford 1988 - On

UNIT PACKAGE: 50



14750

(Toyota: 53879-14010-A,
53879-14020, 53879-22030;
GM: 94841226;
Mazda: LA01-56-135)
Black Nylon

Nylon "U" Nut
Fender/Wheel
Housing Applications
#10 Screw Size
20mm Wide
31mm Long

Panel Range: Up to 1mm
Center of Hole To Edge: 11mm
Toyota, Geo Prizm & Nova and
Mazda

UNIT PACKAGE: 15

19669

Same As 14750 Except For Packing

UNIT PACKAGE: 25

MERCEDES-BENZ



20201
(006-988-30-78)
Natural Nylon

Body Side
Moulding Clip
Body Style 124
1995 - 86

UNIT PACKAGE: 10



20657
(004-988-76-78,
004-988-77-78)
Black Nylon

Moulding Clip
11mm Wide
20mm Long

UNIT PACKAGE: 15



20197
(201-988-07-78)
Black Nylon

Body Side
Moulding Clip
Body Style 201
1993 - 84

UNIT PACKAGE: 10



20202
(201-988-04-78)
Natural Nylon

Body Side Quarter Panel
Moulding Clip
Body Style 201
1995 - 84

UNIT PACKAGE: 10



20897
(002-988-51-81)
Black Nylon

Grille Moulding Clip
Fits Into 7mm Hole
CLK320,
CLK500 & ML350
2003 - On

UNIT PACKAGE: 10

MERCEDES-BENZ



21464
(001-988-44-81)
White Nylon

Front Fender Moulding Clip
Head Size: 12mm x 16mm
Stem Length: 7mm
Overall Height: 16mm
Mercedes-Benz
2000 - 1994

UNIT PACKAGE: 25



21468
(001-988-60-81)
Yellow Nylon

Front Fender
Moulding Clip
Head Size: 12.5mm x 15.5mm
Stem Length: 7mm
Overall Height: 15.5mm
Mercedes-Benz
2000 - 1994

UNIT PACKAGE: 25



21433
(001-988-49-81)
White Nylon

Moulding Clip
Head Size: 16mm x 16mm
Overall Length: 21.5mm
Mercedes-Benz 124 & 201
1995 - 84

UNIT PACKAGE: 25



21466
(001-988-46-81)
White Nylon

Front & Rear Door
Moulding Clip
Width: 18.5mm
Length: 25mm
Overall Height: 21.5mm
Mercedes-Benz
1995 - 1987

UNIT PACKAGE: 25

Sec. 22 MERCEDES-BENZ CLIPS & FASTENERS



21435

(124-988-04-78)
White Nylon

Moulding Clip
Width: 19mm
Length: 20mm
Overall Height: 20mm
Mercedes-Benz
1990 - 85

UNIT PACKAGE: 25



21434

(006-988-89-78)
White Nylon

Moulding Clip
Width: 11mm
Length: 45mm
Overall Height: 16mm
Mercedes-Benz
1999 - 92

UNIT PACKAGE: 25



20199

(006-988-35-78)
White Nylon

Body Side Moulding Clip
Body Style 201
1993 - 87

UNIT PACKAGE: 10



21441

(001-988-50-81)
White Nylon

Moulding Clip
Width: 22.5mm
Length: 23mm
Mercedes-Benz

UNIT PACKAGE: 25



21465

(001-988-80-81)
White Nylon
With Rubber Boot

Moulding Clip
Width: 23mm
Length: 32.5mm
Stem Length: 16mm
Mercedes-Benz
2006 - 1994

UNIT PACKAGE: 15



20773

(211-988-00-81)
Black Nylon

Cowl Cover Retainer
Head Size: 20mm x 43mm
Stem Length: 25mm
Fits Into 8mm Hole
E, CL & S Class
2000 - On

UNIT PACKAGE: 10



20656

(140-698-00-82)
White Nylon

Rocker Moulding Clip
Head Diameter: 12mm x 16mm
Stem Length: 28mm
Overall Length: 36mm

UNIT PACKAGE: 10



21469

(001-988-63-81)
White Nylon

Quarter Panel
Moulding Clip
Width: 19mm
Length: 32mm
Overall Height: 25.5mm
Mercedes-Benz
1995 - 1987

UNIT PACKAGE: 25



21467

(007-988-71-78)
White Nylon

Front & Rear Door
Moulding Clip
Width: 32.5mm
Length: 48mm
Overall Height: 15mm
Mercedes-Benz
2009 - 1994

UNIT PACKAGE: 25

















20205

(001-988-76-81)
White Nylon

Moulding Insert
Head Dia: 11.5mm
Stem Length: 12mm
Fits Into 9mm Hole
Body Styles
170, 202, 203, 208, 210 & 220
1994 - On

UNIT PACKAGE: 25

MERCEDES-BENZ CLIPS & FASTENERS **Sec. 22**

 <p>20659 (201-997-22-81) White Nylon</p> <p>Hood & Trunk Moulding Insert Head Diameter: 7mm Stem Length: 6mm Fits Into 5.5mm Hole C, CL, CLK, E, SLK & S Class 1996 - On</p> <p>UNIT PACKAGE: 15</p>	 <p>16124 (001-988-20-81) Red Nylon</p> <p>Tubular Nut I.D.: 4.5mm, Length: 14mm Fits Into 9mm Hole UNIT PACKAGE: 50</p>	 <p>20404 (000-988-86-25) Natural Nylon</p> <p>Rocker Panel Moulding Screw Grommet Use With M4.2 (#8) Screw Class CL, E & S 1996 - On</p> <p>UNIT PACKAGE: 25</p>
 <p>20200 (001-988-77-81) Natural Nylon</p> <p>Moulding Insert Head Dia: 8mm Stem Length: 5mm Fits Into 7mm Hole Body Styles 202 & 210 1994 - On</p> <p>UNIT PACKAGE: 25</p>	<p>Twice Actual Size</p>  <p>13150 (123-997-03-81) Nylon</p> <p>Barrel Nut For 2mm Stud Fits Into 4mm Hole UNIT PACKAGE: 50</p>	 <p>20315 (673-988-00-25) Black Nylon</p> <p>Screw Grommet #8 (M4.2) Screw Size Head Diameter: 25mm Stem Length: 17mm Body Styles 124, 126, 170, 201, 202, 208 & 210 1991 - On</p> <p>UNIT PACKAGE: 15</p>
 <p>13141 (000-988-15-81) Red Nylon</p> <p>Moulding Insert</p> <p>UNIT PACKAGE: 50</p>	 <p>21499 (BMW: 51-44-7-780-135; Mercedes-Benz: 108-988-00-27) Natural Nylon</p> <p>Tubular Nut Stud Size: 7mm Head Diameter: 16mm Stem Length: 16mm Fits Into 8.5mm Hole BMW, Mercedes-Benz & Universal UNIT PACKAGE: 25</p>	 <p>20643 (000-997-91-86) Black Nylon</p> <p>Retainer Head Diameter: 13mm Stem Diameter: 6.5mm Stem Length: 11mm</p> <p>UNIT PACKAGE: 10</p>
 <p>13144 (000-988-55-81) Blue Nylon</p> <p>Moulding Insert</p> <p>UNIT PACKAGE: 50</p>	 <p>20647 (000-988-16-25) White Nylon</p> <p>Cowl Vent Nylon Nut M3.5 (#6) Screw Size Head Size: 9.5mm x 9.5mm Stem Length: 14mm Fits Into 6.5mm x 7mm Hole UNIT PACKAGE: 25</p>	 <p>21105 (001-988-03-25) Black Nylon</p> <p>Hood Insulation Retainer Head Diameter: 20mm Stem Diameter: 14mm Stem Length: 10mm Mercedes - Benz 2002 - On</p> <p>UNIT PACKAGE: 15</p>
 <p>13157 (000-987-10-81) White Nylon</p> <p>Moulding Insert</p> <p>UNIT PACKAGE: 50</p>	 <p>20646 (001-988-12-25) Natural Nylon</p> <p>M3.5 (#6) Screw Size Head Diameter: 12mm Stem Length: 20mm Fits Into 5.5mm Hole UNIT PACKAGE: 10</p>	

Sec. 22 MERCEDES-BENZ CLIPS & FASTENERS



20188
(003-988-41-78)
White Nylon

Trim Panel Retainer
Small Head Dia: 13mm
Large Head Dia: 18mm
Stem Diameter: 8.5mm
Stem Length: 11mm
Body Styles 107, 108,
109, 114, 115, 123 & 124
1995 - 68

UNIT PACKAGE: 10



13230
(Mercedes
000-990-03-92;
Volvo: 947-098)
Black Nylon

Push-Type Retainer
Head Dia. 10mm
Stem Length: 7mm
Fits Into 5mm Hole

UNIT PACKAGE: 50



20640
(000-990-40-92,
124-990-05-92-9051)
Black Nylon

Push-Type Retainer
Head Diameter: 12mm
Stem Length: 11mm
Fits Into 5mm Hole

UNIT PACKAGE: 25



20735
(463-933-02-78)
Black Nylon

Door Panel Retainer
Top Head Diameter; 11.5mm
Bottom Head Diameter: 18mm
Stem Diameter; 9mm
Stem Length: 14mm
G55 & G500
2002 - On

UNIT PACKAGE: 25



20187
(000-990-34-92)
Black Nylon

Radiator Housing
Push-Type Retainer
Head Diameter: 10mm
Stem Length: 10mm
Fits Into 6mm Hole
Body Styles 116, 123, 124, 126,
129, 140, 170, 201, 208 & 210
1974 - On

UNIT PACKAGE: 15



20639
(000-990-44-92)
Black Nylon

Push-Type Retainer
Head Diameter: 12mm
Stem Length: 11mm
Fits Into 5mm x 5mm Hole

UNIT PACKAGE: 25



20642
(000-990-57-92)
Gray Nylon

Door Panel
Retaining Clip
Top Head Diameter: 13mm
Bottom Head Diameter: 16mm
Stem Diameter: 9mm
Stem Length: 13mm

UNIT PACKAGE: 10



21037
(000-990-84-92)
Black Nylon

Push-Type Retainer
Head Diameter: 10mm
Stem Length: 10mm
Fits Into 6mm Hole
Mercedes - Benz
2005 - On

UNIT PACKAGE: 25



21044
(123-990-05-92,
126-990-03-92)
Black Nylon

Cowl Screen Cover
Push-Type Retainer
Head Diameter: 16mm
Stem Length: 11mm
Fits Into 6.3mm Hole
E, CL & S Class
2000 - On

UNIT PACKAGE: 15



20879
(007-988-99-78,
007-988-34-78)
Green Nylon

Door Trim Panel Retainer
Top Head Diameter: 13mm
Bottom Head Diameter: 17mm
Stem Diameter: 9mm
Stem Length: 14mm
Mercedes-Benz
1996 - On

UNIT PACKAGE: 10



20314
(000-990-37-92)
Black Nylon

Trunk Trim &
General Purpose
Push-Type Retainer
Head Diameter: 13mm
Stem Length: 14mm
Fits Into 8mm Hole
SL500 & SL600 Convertible
1999 - On

UNIT PACKAGE: 15



20641
(000-990-46-92)
Black Nylon

Push-Type Retainer
Head Diameter: 17mm
Stem Length: 15mm
Fits Into 6mm Hole

UNIT PACKAGE: 10

MERCEDES-BENZ CLIPS & FASTENERS **Sec. 22**



20636

(123-990-00-92)
Dark Gray Nylon

Push-Type Retainer
Head Diameter: 12mm
Stem Length: 10mm
Fits Into 8.5mm Hole
UNIT PACKAGE: 15



21086

(Mercedes-Benz:
230-990-01-92;
Chrys: 6104900-A)
Black Nylon

Hood Insulation & Cowl Grille
Push-Type Retainer
Head Diameter: 20mm
Stem Length: 10mm
Fits Into 8mm Hole
Mercedes GL, M, R,
SL & SLK
2005 - On
Chrysler 2010 - On
UNIT PACKAGE: 15



21431

(BMW: 16-13-1-176-747;
Mercedes-Benz: 003-990-02-51)
Black Nylon

Nylon Flange Nut
Stud Size: 5mm
10mm Hex
Flange Diameter: 16mm
Overall Height: 11mm
BMW & Mercedes-Benz
1997 - On
UNIT PACKAGE: 25



20772

(001-990-13-92)
Black Nylon

Back Glass Moulding
Push-Type Retainer
Head Diameter: 15mm
Stem Length: 11mm
Fits Into 5mm Hole
C & SL Class
2001 - On
UNIT PACKAGE: 15



20638

(201-990-02-92)
Black Nylon

Push-Type Retainer
Head Diameter: 20mm
Stem Length: 14mm
Fits Into 8.5mm Hole
UNIT PACKAGE: 25



20653

Gray Nylon

Wire Routing Clip
Inside Diameter: 7mm x 10mm
Fits Into 6mm Hole
BMW & Mercedes
UNIT PACKAGE: 50



20909

(124-990-04-92)
Black Nylon

Push-Type Retainer
Head Diameter: 16mm
Stem Length: 18mm
Fits Into 7mm Hole
Mercedes-Benz
2003 - On
UNIT PACKAGE: 15



20203

(124-990-07-92)
Black Nylon

Push-Type Retainer
Head Size: 11mm x 14mm
Stem Length: 8mm
Fits Into 7mm x 8mm Hole
Body Styles
124, 129, 140, 170, 202,
203, 208, 210, 215, & 220
1986 - On
UNIT PACKAGE: 25



Not Actual Size

20654

(001-997-42-90)
Black Nylon

Cable Strap
Overall Length: 120mm (4-3/4")
Fits Into 8mm Hole
UNIT PACKAGE: 10



20637

(123-990-02-92)
Black Nylon

Push-Type Retainer
Head Diameter: 20mm
Stem Length: 9mm
Fits Into 8mm Hole
UNIT PACKAGE: 10



20645

(201-990-00-50)
Black Nylon

Rear Compartment
Carpet Retainer
Fits Onto 5mm Stud
Head Diameter: 24mm
10mm Hex
UNIT PACKAGE: 25



Not Actual Size

21305

(Not Available From O.E.M.)
Natural Nylon

Push-Mount Cable Strap
Overall Length: 156mm (6-1/8")
Strap Width: 5mm (3/16")
Snaps Into 6.3mm (1/4") Hole
Maximum Bundle Diameter:
40mm (1-9/16")
European Makes & Universal
UNIT PACKAGE: 25

Not Actual Size



20655

(114-997-02-90)
Black Nylon

Cable Strap
Overall Length: 160mm (6-3/8")
Fits Into 8mm Hole

UNIT PACKAGE: 10



20648

(123-994-01-45)
Zinc & Yellow

M2.9 (#4) Screw Size
Panel Range: .7mm - 1.5mm
Center of Hole to Edge: 4mm

UNIT PACKAGE: 50



20649

Zinc & Yellow

M3.5 (#6) Screw Size
Panel Range: .5mm - 1.5mm
Center of Hole to Edge: 8mm

UNIT PACKAGE: 50



13223

(BMW: 0712-9-925-708;
Mercedes: 000-994-25-45)
Plated

"U" Type Nut
4.2mm (#8) Screw Size
Panel Range: 3mm-4mm
Center of Hole To Edge: 7mm

UNIT PACKAGE: 50



13224

(000-994-04-45)
Plated

"U" Type Nut
4.2mm (#8) Screw Size
Panel Range: .5mm-1.7mm
Center of Hole To Edge: 8mm

UNIT PACKAGE: 50



20650

(123-994-08-45)
Zinc & Yellow

M4.2 (#8) Screw Size
Panel Range: .5mm - 2.5mm
Center of Hole to Edge: 14mm

UNIT PACKAGE: 25



13218

(BMW: 0712-9-925-737;
Mercedes 000-994-06-45)
Plated

"U" Type Nut
4.8mm Screw Size
Panel Range: .5mm-1.7mm
Center of Hole To Edge: 7mm

UNIT PACKAGE: 50



13215

(BMW: 0711-9-916-945,
Mercedes 000-994-14-45)
Plated

"U" Type Nut
4.8mm Screw Size
Panel Range: .8mm-1.7mm
Center Of Hole To Edge: 11mm

UNIT PACKAGE: 50



13216

Zinc

"U" Type Nut
4.8mm Screw Size
Panel Range: .9mm-2.0mm
Center of Hole to Edge: 8mm

UNIT PACKAGE: 25



13220

(Mercedes:
000-994-09-45;
Volvo: 946-418;
Opel: 20-72-175)
Plated

"U" Type Nut
6.3mm Screw Size
Panel Range: .7mm-1.5mm
Center of Hole To Edge: 13mm

UNIT PACKAGE: 50



20651

(001-990-00-91)
Zinc

M6 - 1.0 Screw Size
Panel Range: .5mm - 1.7mm
Center of Hole To Edge: 15mm

UNIT PACKAGE: 10

MINI-COOPER



21659

(07-13-2-757-821)
Gray Nylon

Moulding Clip
Top Head Size: 11mm x 19mm
Bottom Head Diameter: 21mm
Stem Length: 11mm
Mini-Cooper
2002 – On

UNIT PACKAGE: 15



21527

(07-13-7-073-915)
White Nylon

Trim Panel & Fender Flare
Moulding Clip
Top Head Size: 11.5mm x 19mm
Bottom Head Diameter: 21mm
Stem Length: 13mm
Fits Into 8mm Hole
Mini Cooper S
2002 – On

UNIT PACKAGE: 15



21143

(51-71-1-496-621)
Black Nylon

Rocker Moulding Retainer
Head Size: 8.5mm x 14mm
Stem Size: 5mm x 7.5mm
Stem Length: 14mm
Mini Cooper
2002 – On

UNIT PACKAGE: 25



21137

(07-13-0-702-516)
Black Nylon

Rear Quarter Wheel Opening
Moulding Retaining Clip
Top Head Diameter: 13mm
Middle Head Diameter: 15mm
Bottom Head Diameter: 15mm
Stem Diameter: 10mm
Stem Length: 8mm
Fits Into 8mm Hole
Mini Cooper
2002 – On

UNIT PACKAGE: 25



21139

(07-14-7-145-753)
White Nylon

Body Side Moulding Retainer
With Sealer
Top Head Diameter: 12mm
Middle Head Diameter: 15mm
Bottom Head Diameter: 18mm
Stem Diameter: 9.5mm
Stem Length: 11mm
Mini Cooper
2002 – On

UNIT PACKAGE: 25



21138

(51-43-7-001-491-2)
White Nylon

Headliner Retainer
Top Head Diameter: 14mm
Middle Head Diameter: 15mm
Bottom Head Diameter: 18mm
Stem Diameter: 9mm
Stem Length: 14mm
Mini Cooper
2005 – On

UNIT PACKAGE: 25



20570

(Mini-Cooper: 07-13-0-702-715;
Honda: 75307-SN7-000)

Wheel Opening
Nylon Moulding Nut
With Brass Insert
M4-0.7 Thread
12mm Flange O.D.
10mm Hex
Height: 11mm

UNIT PACKAGE: 15



(Not Actual Size)

21305

(Not Available From O.E.M.)
Natural Nylon

Push-Mount Cable Strap
Overall Length: 156mm (6-1/8")
Strap Width: 5mm (3/16")
Snaps Into 6.3mm (1/4") Hole
Maximum Bundle Diameter:
40mm (1-9/16")
European Makes & Universal

UNIT PACKAGE: 25

MITSUBISHI



19343

(MB608137)
Natural Nylon

Windshield Moulding Clip
Diamante
1995-91

UNIT PACKAGE: 15



19474
 (MR154128)
 Natural Nylon
 Windshield Moulding Clip
 Diamante
 1997-On
 UNIT PACKAGE: 15



19475
 (MB608156)
 Natural Nylon
 Windshield Moulding Clip
 With Adhesive Backing
 Diamante
 1996-91
 UNIT PACKAGE: 10



19745
 (MB880455)
 Yellow Nylon
 Windshield Moulding Clip
 Montero
 1992-On
 UNIT PACKAGE: 10

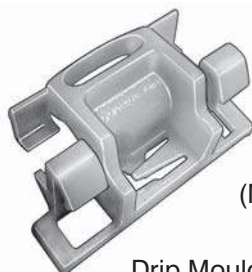

19314
 (MB814419)
 Nylon
 Drip Moulding
 & Garnish
 Moulding Clip
 Galant
 1993-On
 UNIT PACKAGE: 25



17195
 Black Nylon
 Grille Clip
 13mm Wide
 22mm Long
 Ford Escort, Honda,
 Isuzu, Mitsubishi & Plymouth Laser
 UNIT PACKAGE: 25



21623
 (Mitsubishi: MR221507;
 Toyota: 90467-13075)
 Gray Nylon
 Radiator Grille Clip
 Width: 14mm
 Length: 24mm
 Mitsubishi Diamante, Endeavor
 & Galant
 1997 - On
 Toyota 4 Runner, Highlander
 & Land Cruiser
 1998 - On
 UNIT PACKAGE: 25



20572
 (MB846992)
 White Nylon
 Rocker Panel Retainer
 Top Head Diameter: 12mm
 Bottom Head Diameter: 16mm
 Stem Length: 14mm
 Fits Into 7mm Hole
 Montero
 2001 - On
 UNIT PACKAGE: 10



19330
 (MB608140)
 White Nylon
 Trunk Air Dam
 Side Moulding Clip
 Diamante
 1991-On
 UNIT PACKAGE: 10



21632
 (MU480001)
 Natural Nylon
 M3.5(#6) Screw Size
 Head Size: 10mm x 10mm
 Stem Length: 7mm
 Fits Into 6mm x 6mm Hole
 Mitsubishi Eclipse and Chrysler
 Avenger, Colt, Jeep Eagle Talon,
 Laser & Sebring
 2000 - 1984
 UNIT PACKAGE: 50



14255
 (Mitsubishi: MS-480001;
 Honda: 75522-611-0000;
 Mazda: 9991-00-412)
 Black Nylon
 #8 Screw Size
 9.5mm Wide
 9.5mm Long
 Snaps Into 7mm x 7mm Hole
 UNIT PACKAGE: 50



19487
 (MB419858)
 Natural Nylon
 Scuff Plate Screw Grommet
 #6 Screw Size
 Diamante
 1995-91
 UNIT PACKAGE: 15



13932
 (Mitsubishi: MS-480002;
 Toyota: 90189-05013)
 Natural Nylon
 #10 Screw Size
 12mm Wide
 12mm Long
 Fits Into 8mm x 9mm Hole
 UNIT PACKAGE: 50



19485

Natural Nylon

#14 (M6.3) Screw Size
Fits Into 3/8" x 3/8" Hole
Eclipse

UNIT PACKAGE: 10



20573

(MB817060)
White Nylon

Headliner Nylon Nut
Head Diameter: 15mm
Inside Diameter: 6mm
Stem Length: 11mm
Fits Into 9mm Hole
Montero
1997 - On

UNIT PACKAGE: 15



14335

(Mitsubishi: MB-106212;
Nissan: 96706-H9400,
-K1300,-K1351)
Natural Nylon

Screw Grommet
#8 Screw Size
Head Diameter: 13.5mm
Stem Length: 16mm
Fits Into 6mm x 6mm Hole

UNIT PACKAGE: 50



14695

(Mitsubishi: MS-480012;
Honda: 90661-SC7-0030;
Mazda: H001-50-841;
Nissan: 01651-00481, 74798-S9000;
Toyota: 90189-06042)
White Nylon

Screw Grommet
#8 Screw Size
Head Diameter: 16mm
Stem Length: 17mm
Fits Into 8mm x 8mm Hole

UNIT PACKAGE: 25



19322

(MU480034)
Natural Nylon

Rear Side & Trunk Trim
Screw Grommet
#8 Screw Size
Eclipse
1994-On

UNIT PACKAGE: 15



14275

(Mitsubishi: MB-098145;
Nissan: 01281-00023, 01281-00231;
Toyota: 90189-06001)
White Nylon

Screw Grommet
#10 Screw Size
Head Diameter: 18mm
Stem Length: 17mm
Fits Into 8.5mm x 8.5mm Hole

UNIT PACKAGE: 25



20581

(MR478263)
Black Rubber

Bumper Cover &
Garnish Moulding Grommet
With Sealer
Head Diameter: 16mm
Stem Length: 20mm
Fits Into 9mm Hole
Use With Auveco 20580
Chrysler Sebring & Stratus
And Mitsubishi Eclipse
2000 - On

UNIT PACKAGE: 15



20565

(MB271999)
Black Nylon

Bumper Cover Grommet
Head Diameter: 24mm
Stem Length: 21mm
Fits into 13mm Hole
Chrysler Colt, Eagle, Sebring
& Stratus 1989 - On
Mitsubishi Eclipse, Galant
& Mirage 1993 - On

UNIT PACKAGE: 10



19324

(MB888561)
Natural Nylon

Drip Moulding Screw Grommet
#8 Screw Size
Eclipse
1994-On

UNIT PACKAGE: 25



21025

(MB645307)
Black Nylon

Back Glass Lower Moulding,
Quarter Glass Moulding &
Spoiler Grommet With Sealer
Head Size: 12mm x 16mm
Stem Length: 14mm
Dodge Avenger & Stealth and
Chrysler Sebring
1991 - On
Mitsubishi
1991 - On

UNIT PACKAGE: 15



19331

(MB869072)
Black Nylon

Headliner & Trunk Trim
Retaining Clip
Head Diameter: 14mm
Stem Length: 11mm
Fits Into 7mm Hole
Diamante
1995-91

UNIT PACKAGE: 15



20381

(Honda: 90667-671-013ZA;
Mitsubishi: MC440901;
Nissan: 62660-48600-1)
Black Nylon

Trim Panel Retaining Clip
Head Diameter: 16mm
Stem Diameter: 7mm
Stem Length: 16mm
Honda, Mitsubishi &
Nissan

UNIT PACKAGE: 25



19334

(MB566720)
Natural Nylon

Rear Pillar Trim &
Air Inlet Grille Retainer
Small Head Diameter: 12mm
Large Head Diameter: 16mm
Stem Diameter: 9mm
Stem Length: 15
Eclipse
1994-On

UNIT PACKAGE: 15



21118

(MB374270, MB374271)
White Nylon

Trim Panel Retainer
Top Head Diameter: 13mm
Middle Head Diameter: 16mm
Bottom Head Diameter: 18mm
Stem Diameter: 10mm
Stem Length: 14mm
Chrysler Laser, Dodge Stealth,
Jeep Eagle & Talon and
Mitsubishi Eclipse & Montero
1989 - On

UNIT PACKAGE: 15



14720

(HB-121467)
Black Nylon

Retaining Clip
Head Diameter: 18mm
Shank Length: 15mm
Snaps Into 8mm Hole
Panel Thickness: 5mm

UNIT PACKAGE: 25



19320

(MB696120)
White Nylon

Side Garnish &
Moulding Trim Retainer
Small Head Diameter: 12mm
Large Head Diameter: 16mm
Stem Diameter: 9mm
Stem Length: 11mm
Eclipse
1994-On

UNIT PACKAGE: 15



19325

(MU481027)
Brown Nylon

Hood Weatherstrip
Retainer
Head Size: 5mm x 13mm
Stem Diameter: 7mm
Stem Length: 6mm
Eclipse & Diamante
1991-On

UNIT PACKAGE: 25



19323

(MU481187)
Black Nylon

Hood Insulation Retainer
Head Diameter: 26mm
Stem Diameter: 10mm
Stem Length: 8mm
Diamante
1993-On

UNIT PACKAGE: 15



20571

(MR435918)
White Nylon

Rocker Panel Retainer
Top Head Diameter: 13mm
Bottom Head Diameter: 18mm
Stem Diameter: 9mm
Stem Length: 9mm
Montero
2001 - On

UNIT PACKAGE: 15



21658

(MR288150)
Black Nylon

Push-Type Retainer
Head Diameter: 15mm
Stem Length: 11mm
Fits Itno 6mm Hole
Endeavor, Galant, Lancer,
Mirage, Montero & Outlander
1997 - On

UNIT PACKAGE: 10



19385

(MB020923)
Gray Nylon

Hood Insulation Retainer
Head Diameter: 26mm
Stem Diameter: 10mm
Stem Length: 8mm
Jeep Eagle &
Mitsubishi Eclipse
1992-On

UNIT PACKAGE: 10



21140
(MB619582)
Black Nylon

Interior Trim, Bumper & Grille
Push-Type Retainer
Head Diameter: 15mm
Stem Length: 12mm
Fits Into 6.3mm Hole
Eclipse, Endeavor, Lancer &
Outlander
2002 - On

UNIT PACKAGE: 25



20580
(MR478262)
Black Nylon

Bumper Cover &
Garnish Moulding
Push-Type Retainer
Top Head Diameter: 15mm
Bottom Head Diameter: 14mm
Stem Length: 12mm
Fits Into 7mm Hole

Use With Auveco 20581
Chrysler Sebring & Stratus
And Mitsubishi Eclipse
2000 - On

UNIT PACKAGE: 15



19239
(Honda: 91512-SX0-003;
Mitsubishi: MU000319;
GM: 11519949)
Black Nylon

Front Fender &
Bumper Support
Push-Type Retainer
Head Diameter: 20mm
Stem Length: 11mm
Fits Into 8mm Hole
Acura 3.5RL, Honda Accord,
Prelude & Odyssey
1994-On
Mitsubishi Lancer
2002-On
GM 1997 - On

UNIT PACKAGE: 25



20247
(MR200300)
Black Nylon

Fender & Bumper
Push-Type Retainer
Head Diameter: 18mm
Stem Length: 12mm
Fits Into 9mm Hole
Honda & Mitsubishi
1998 - On

UNIT PACKAGE; 15



17351
(MB-253964)
Black Nylon

Front & Rear Bumper
Push-Type Retainer
Head Diameter: 17mm
Stem Length: 10mm
Fits Into 7mm Hole
Tredia
1988-83

UNIT PACKAGE: 10



17472
(Mitsubishi: MB547806;
Nissan: 63854-01A00)
Black Nylon

Front Bumper Fascia
Push-Type Retainer
Head Diameter: 20mm
Stem Length: 20mm
Fits Into 8mm Hole

UNIT PACKAGE: 15



19140
(Acura: 90505-SL0-003;
GM: 94852638;
Mitsubishi: MB888869;
Toyota: 90467-08155)
Black Nylon

Push-Type Retainer
Head Diameter: 20mm
Stem Length: 21mm
Fits Into 8mm Hole
Acura, Dodge Avenger,
Eagle Talon, Geo Prizm, Mitsubishi
Eclipse & Galant
and Toyota
1993-On

UNIT PACKAGE: 5



18951
(MR-138807)
Black Nylon

Front Bumper
& Support
Push-Type Retainer
Head Diameter: 20mm
Stem Length: 26mm
Fits Into 8mm Hole
Eclipse
1994-On

UNIT PACKAGE: 5



19328
(MR201466)
White Nylon

Trunk Trim Cap
Eclipse
1994-On

UNIT PACKAGE: 15



20380

(Not Supplied By O.E.M.)
Black Nylon

Cable Strap
Length: 200mm (8")
5mm (3/16") Wide
Max. Bundle Dia: 44mm (1-3/4")
Fits Into 6.3mm (1/4") Hole
Import Cars

UNIT PACKAGE: 25



13225

Plated

"U" Type Nut
4.2mm (#8) Screw Size
11mm Wide 16.5mm Long
Panel Range: .5mm-2.5mm
Center of Hole to Edge: 8mm

UNIT PACKAGE: 50

HELPFUL HINTS FOR USING THE AUVECO CATALOG

1. **The color-coded pages** signify various sections which are as follows:
 BLUE-Metric Items
 BEIGE-Electrical Accessories
 GREEN-Assortments, Cabinets, Bins & Racks
 GRAY-Key Blanks & Accessories
 PINK-Import Car Body Hardware
2. Most pictures and illustrations are actual size.
3. We have **Specification Charts** for:
Body Bolts (pages 20 & 49-50)
Special Tapping Screws (pages 23-26 & 54-57)
License Plate Screws (pages 33-34)
"Xmas Tree" Retainers (pages 404-413)
Push-Type Retainers (pages 450-460)
4. We have **three different types of indexes** in the front of the catalog to assist you.
 PICTORIAL QUICK INDEX
 ALPHABETICAL INDEX
 NUMERICAL INDEX
5. There are two OEM Part Cross References at the back of the catalog.



19738
(80897-10Y00)
Natural Nylon

Door Panel Clip
Width: 12mm
Length: 25mm
Stem Length: 16mm
Fits Into 6mm Hole
Altima, Infiniti & Sentra
1997 - On

UNIT PACKAGE: 15



21085
(Not Available
From O.E.M.)
Light Blue Nylon

Rocker Panel
Moulding Clip
Overall Height: 15mm
Stem Length: 9mm
Murano
2003 - On

UNIT PACKAGE: 15



21618
(01553-08911)
White Nylon

Scuff Plate
Moulding Clip
Top Head Size: 12mm x 15mm
Bottom Head Diameter: 16mm
Stem Length: 12mm
Fits into 8.5mm Hole
Maxima
1999 - On

UNIT PACKAGE: 15



16860
(62318-01W00)
Dark Gray Nylon

Grille Clip
Overall Height:
21.5mm (27/32")

UNIT PACKAGE: 25



21291
(76988-4N000)
White Nylon

Moulding Clip
Top Head Size: 8mm x 15mm
Bottom Head Diameter: 15mm
Stem Diameter: 5.3mm
Stem Length: 9mm
Quest & 370Z
2004 - On

UNIT PACKAGE: 25



20873
(73858-8J000)
Black Nylon

Drip Rail Moulding Clip
Width: 13.5mm
Length: 31mm
Nissan
2000 - On

UNIT PACKAGE: 10



21121
(01553-03831)
Black Nylon

Grille Clip
Overall Height: 22mm (7/8")
Maxima & Stanza
1982 - On

UNIT PACKAGE: 25



21285
(76882-EG01A)
Black Nylon

Rocker Panel
Moulding Clip
With Sealer
Top Head Size: 10mm x 15mm
Bottom Head Size: 18mm
Stem Length: 12mm
Fits Into 8mm Hole
Altima and Maxima
2010 - On

UNIT PACKAGE: 15



20961
(Not Available From O.E.M.)
White Nylon

Drip Moulding Clip
With Sealer
Top Width: 25mm
Overall Height: 16mm
Fits Into 5mm Hole
Infiniti M45, I30 & G35
2005 - On
Nissan Altima, Maxima
& 350Z
2002 - On

UNIT PACKAGE: 15



21619
(76882-0M060)
Black Nylon

Grille Clip
Overall Height: 25mm (1")
Frontier, Krom & SL
2006 - On

UNIT PACKAGE: 15



20614
(66820-3S510)
White Nylon

Cowl Vent Retainer
Head Size: 10mm x 18mm
Stem Diameter: 6mm
Stem Length: 13mm
Frontier & Xterra
1998 - On

UNIT PACKAGE: 25



21117
(85284-CD000)
White Nylon

Bumper Retainer
With Sealer
Head Diameter: 22mm
Stem Length: 21mm
Overall Length: 39mm
Nissan
2004 - On

UNIT PACKAGE: 10



15469
Nylon

Windshield Reveal Moulding Clip
15mm Wide, 25.5mm Long
Nissan & Mazda

UNIT PACKAGE: 25



12583
(76884-90100)
Nylon

Step Moulding Clip
24mm Wide
14mm Long
Snaps Into 8mm Hole

UNIT PACKAGE: 15



14333
(79896-P7100)
Nylon

Moulding Clip
27mm Wide; 25mm Long
Fits Into 14mm x 16mm Hole

UNIT PACKAGE: 10



17349
(79796-71E00)
Nylon

Window Reveal Moulding Clip
Back Glass
Maxima
1990-On

UNIT PACKAGE: 25



12585
(255 Y 3616-10)
Nylon

Side Window Moulding Clip
12mm Wide
12mm Long
Snaps Into 5mm Hole

UNIT PACKAGE: 15



15468
(72826-01P00)
Nylon

Windshield Moulding Clip
11mm Wide, 40mm Long
300ZX
1984-On

UNIT PACKAGE: 15



15470
(72727-W1000)
White Nylon

Windshield Reveal Moulding Clip
21mm Wide, 40mm Long

UNIT PACKAGE: 15



21617
(76882-0E700)
White Nylon

Rocker Moulding Clip
Top Head Size: 14mm x 14mm
Bottom Head Diameter: 16mm
Stem Length: 10mm
Altima
1996 - On

UNIT PACKAGE: 15



17348
(73856-51E00)
Nylon

Roof Side Moulding Clip
Stanza
1990-On

UNIT PACKAGE: 25



21097
(Not Available From O.E.M.)
Black Nylon

Windshield Moulding Clip
Width: 22mm
Length: 46mm
Altima
2004 - On

UNIT PACKAGE: 25

Not Actual Size



18113

(69951-12180)
Nylon With
Steel Threaded Insert
Glass Mount
M6-1.0 Thread
Nissan, Ford & Imports
UNIT PACKAGE: 5

Not Actual Size



21108

(62228-7Y000)
Black Nylon
Front Bumper Cover
Width: 40mm
Length: 93mm
Maxima & Quest
2004 - On
UNIT PACKAGE: 5



13931

(26023-H1000)
White Nylon
Screw Grommet
For Headlight Adjusting Screws
Use With 5mm Screws
14mm Wide
14mm Long
UNIT PACKAGE: 50



13930

(Nissan: 96706-B0700;
Mazda: 9991-00-412)
White Nylon
#8 Screw Size
9.5mm Wide 9.5mm Long
Snaps Into 7mm x 7mm Hole
UNIT PACKAGE: 50



14274

(Mazda: 9991-00-601;
Honda: 75521-611-0000;
Nissan: 96706-P0105;
Toyota: 90189-06010)
Natural Nylon
#10 Screw Size
13mm Wide; 13mm Long
Snaps Into 8.5mm x 8.5mm Hole
UNIT PACKAGE: 25



19897

(76881-9E000)
Green Nylon
Door Panel Sash
Screw Grommet
M4.2 (#8) Screw Size
Head Size: 10mm Sq.
Stem Length: 8mm
Maxima
1999 - On
UNIT PACKAGE: 25



14334

(96706-N8000)
Natural Nylon
#8 Screw Size
12mm Wide; 15mm Long
Fits Into 8mm x 12mm Hole
UNIT PACKAGE: 25



14313

(Nissan: 62698-V7000,
68425-H5000;
Honda: 90662-671-0030;
Mazda: 9991-00-503)
Natural Nylon
#10 Screw Size
17mm Wide; 17mm Long
Snaps Into 8mm x 8.5mm Hole
UNIT PACKAGE: 25



20764

(01281-00831)
Natural Nylon
Bumper, Fender & Light
Screw Grommet
M4.2 (#8) Screw Size
Head Diameter: 16mm
Stem Length: 10mm
Fits Into 9mm x 9mm Hole
Nissan 240SX, Altima,
Frontier, Maxima, Pathfinder,
Quest & Xterra And Infiniti
1989 - On
UNIT PACKAGE: 25



14331

(01281-00022)
Natural Nylon
#10 Screw Size
Head Diameter: 13mm
Fits Into 8mm x 8mm Hole
UNIT PACKAGE: 50



17342

(01281-00441)
Black Nylon
Front Bumper Apron
Nylon Nut
#10 Screw Size
15mm Head Diameter
Snaps Into 8mm x 8mm Hole
Stanza
1990-On
UNIT PACKAGE: 25



20266

(62319-0W000)
Natural Nylon
Front Bumper
Nylon Nut
M5.5 (#12) Screw Size
Head Dia: 16mm
Stem Length: 11mm
Frontier Truck
1997 - On
UNIT PACKAGE: 10



20257
(76848-50Y00)
Blue Nylon

Windshield Moulding
Screw Grommet
Head Size: 12mm x 16mm
Stem Length: 12mm
M3.5 (#6) Screw Size
Maxima
1999 - On

UNIT PACKAGE: 10



14335
(Nissan: 96706-H9400;
-K1300, -K1351;
Mitsubishi: MB-106212)
Natural Nylon

Screw Grommet
#4 Screw Size
Head Diameter: 13.5mm
Stem Length: 16mm
Fits Into 6mm x 6mm Hole

UNIT PACKAGE: 50



14275
(Nissan: 01281-00023,
01281-00231;
Mitsubishi: MB-098145;
Toyota: 90189-06001)
White Nylon

Screw Grommet
#10 Screw Size
Head Diameter: 18mm
Stem Length: 17mm
Fits Into 8.5mm x 8.5mm Hole

UNIT PACKAGE: 25



14724
(96706-H2500)
Natural Nylon

Screw Grommet
#6 Screw Size
Head Diameter: 11.5mm
Stem Diameter: 9.5mm
Fits Into 7mm x 7mm Hole

UNIT PACKAGE: 25



14695
(Nissan: 01651-00481
74798-S9000;
Honda: 90661-SC7-0030;
Mazda: H001-50-841;
Mitsubishi: MS-480012;
Toyota: 90189-06042)
White Nylon

Screw Grommet
#8 Screw Size
Head Diameter: 16mm
Stem Length: 17mm
Fits Into 8mm x 8mm Hole

UNIT PACKAGE: 25



21621
(01553-02913)
White Nylon

Moulding Grommet
With Sealer
M4.2 (#8) Screw Size
Head Diameter: 14mm
Stem Length: 8mm
Fits Into 8mm Hole
Nissan Frontier, Pathfinder &
Titan and Infiniti QX4 & QX56
1996 - On

UNIT PACKAGE: 15



14366
(Nissan: 96706-89901;
Mazda: 9991-00-402)
Natural Nylon

Screw Grommet
#6 Screw Size
9.5mm Wide; 9.5mm Long
Stem Length: 16mm
Fits Into 7mm x 7mm Hole

UNIT PACKAGE: 50



21324
(01281-00691)
Natural Nylon

Screw Grommet
With Sealer
4.2 (#8) Screw Size
Head Diameter: 16mm
Stem Length: 20mm
Nissan 240SX, Altima, Frontier,
Maxima, Pathfinder & Titan
and Infiniti I30, I35 & Q45
1989 - On

UNIT PACKAGE: 15



19293
(01281-00601)
Natural Nylon

Body Side Moulding
Floor & Trunk
Screw Grommet
M4.8 (#10) Screw Size
Maxima, Sentra,
240SX & 300ZX
1986-On

UNIT PACKAGE: 15



21367
(01281-00501)
White Nylon

Body Side Moulding
Screw Grommet
With Sealer
M3.5 (#6) Screw Size
Head Size: 9.5mm x 9.5mm
Stem Length: 16mm

UNIT PACKAGE: 15



20604
(01281-00711)
Natural Nylon

Rocker Moulding
Screw Grommet
M4.2 (#8) & M4.8 (#10) Screw Size
Head Diameter: 20mm
Stem Length: 15mm
Nissan & Infiniti
1995 - On

UNIT PACKAGE: 10

E-mail Your New
Item Suggestions
For Individual Products
And
Assortments To
mail@auveco.com



21111

(01281-00331)
Natural Nylon

Bumper, Rocker Panel
& Light Mounting
Screw Grommet
With Sealer
M6.3 (#14) Screw Size
Head Diameter: 20mm
Stem Length: 16mm
Fits Into 10mm Square Hole
Infiniti
1997 - On
Nissan
1996 - On

UNIT PACKAGE: 25



20736

(01281-01081)
Natural Nylon

Front Bumper Nylon Nut
M4.8 (#10) Screw Size
Flange Diameter: 16mm
Overall Length: 22mm
Nissan & Infiniti
1997 - On

UNIT PACKAGE: 15



14690

(Nissan: 78856-R4301,
Honda: 90683-693-0000)
White Nylon

Screw Grommet
#10 Screw Size
12mm Wide; 19mm Long
Stem Length: 17mm
Fits Into 8mm x 15mm Hole

UNIT PACKAGE: 25



21622

(76848-71S00)
Yellow Nylon

Pillar Moulding Grommet
With Sealer
M5.5 (#12) Screw Size
Head Size: 15.4mm x 19mm
Stem Length: 15mm
Nissan 370Z & Quest and
Infiniti G37 & Q45
2002 - On

UNIT PACKAGE: 15



20166

(76881-0P000)
Natural Nylon

Window Moulding
Screw Grommet
#8 Screw Size
Head Size: 16mm x 22mm
Stem Length: 16mm
Sentra & Stanza
1994 - On

UNIT PACKAGE: 15



20786

(76848-8J010)
Black Nylon

Headlight Assembly Grommet
Head Size: 17mm x 23mm
Stem Length: 10mm
Altima
2002 - On

UNIT PACKAGE: 10



17196

(62380-U7400)
Black Nylon

Grille Grommet
22mm Wide, 26mm Long
Nissan 1987-On

UNIT PACKAGE: 10



21318

(01281-0005U)
Black Nylon

Grille Grommet
Head Diameter: 20mm
Stem Length: 13mm
Fits Into 11mm Hole
Frontier & Titan
2005 - On

UNIT PACKAGE: 25



19736

(76988-3J000)
White Nylon

Kick Plate Retainer Grommet
Head Size: 14mm x 34mm
Stem Length: 14mm
Altima
1997-On

UNIT PACKAGE: 15



20790

(85222-0M000)
Black Nylon

Rear Bumper
Fascia Clip
With Sealer
Overall Height: 35mm
Stem Length: 16mm
Pathfinder
2004 - On

UNIT PACKAGE: 5



20813
(63846-9E000)
Natural Nylon

Rear Bumper
Moulding Grommet
With Sealer
Head Size: 18mm x 18mm
Stem Length: 15mm
Altima
2001 - 1998

UNIT PACKAGE: 15



21229
(65810-K2000)
Black Nylon

Hood Seal
Retaining Clip
Head Size: 6.4mm x 16mm
Stem Diameter: 3.5mm x 6mm
Stem Length: 10mm
Nissan Maxima & Pathfinder and
Infiniti I30, I35, Q45 & QX4
2004 - 1996

UNIT PACKAGE: 25



14352
(76876-W5000)
Black Nylon

Retaining Clip
Head Diameter: 13mm
Stem Length: 13mm
Fits Into 5mm Hole
Panel Thickness: 4mm
UNIT PACKAGE: 50



17633
(66820-88E00)
Nylon

Cowl Screen Pin Retainer
Maxima
1990-On

UNIT PACKAGE: 25



17634
(01553-01781)
Black Nylon

Cowl Grille Retainer
Head Dia: 12mm
Stem Length: 16mm
Stem Dia: 6mm
240SX
1990-On

UNIT PACKAGE: 25



17452
(01553-00545)
Black Nylon

Bumper Fascia Retainer
Head Diameter: 13mm
Stem Length: 15mm
Fits Into 5mm Hole
Sentra
1990-On

UNIT PACKAGE: 25



21588
(80850-CA003)
Black Nylon

Weatherstrip Retainer
Head Diameter: 8mm
Stem Diameter: 5.3mm
Stem Length: 7mm
Murano & Rouge
2003 - On

UNIT PACKAGE: 25



14355
(01553-00401)
Black Nylon

Retaining Clip
Head Diameter: 11mm
Stem Length: 13mm
Snaps Into 5mm Hole
Panel Range: 4mm

UNIT PACKAGE: 50



14737
(Nissan: 01553-00172;
Toyota: 90467-07050)
Black Nylon

Retaining Clip
Head Diameter: 13mm
Stem Length: 15mm
Fits Into 5mm Hole
Panel Thickness: 3mm

UNIT PACKAGE: 25



21295
(01553-08961)
Black Nylon

Weatherstrip Retaining Clip
Head Diameter: 10mm
Stem Diameter: 6mm
Stem Length: 8mm
Altima
2009 - On

UNIT PACKAGE: 25



14349
(Mazda: 9926-40-543A;
Nissan: 01553-00291)
Black Nylon

Retaining Clip
Head Diameter: 11mm
Stem Length: 15mm
Fits Into 5.5mm Hole
Panel Thickness: 5mm

UNIT PACKAGE: 50



14723
(62869-N4700)
Black Nylon

Retaining Clip
Head Diameter: 14mm
Stem Length: 11mm
Fits Into 6mm Hole
Panel Thickness: 4mm

UNIT PACKAGE: 25



14353
(76906-T3000)
Black Nylon

Retaining Clip
Head Diameter: 14mm
Stem Length: 16mm
Snaps Into 6mm Hole
Panel Thickness: 5mm
UNIT PACKAGE: 50



20671
(01553-0052U)
Black Nylon

Trim Panel
Retaining Clip
Head Diameter: 20mm
Stem Diameter: 9.5mm
Stem Length: 15mm
Frontier Xterra
2000 - On

UNIT PACKAGE: 25



20256
(01553-01182)
Black Nylon

Splash Shield Retainer
Head Dia: 15mm
Stem Dia: 4.5mm
Stem Length: 14mm
Frontier Truck
1997 - On

UNIT PACKAGE: 50



14348
(27948-M7002)
Black Nylon

Retaining Clip
Head Diameter: 16mm
Stem Length: 15mm
Snaps Into 5mm Hole
Panel Thickness: 4mm
UNIT PACKAGE: 25



14356
(01553-00051)
Black Nylon

Retaining Clip
Head Diameter: 20mm
Stem Length: 16mm
Snaps Into 7mm Hole
Panel Thickness: 7mm

UNIT PACKAGE: 50



16776
(Honda: 90667-SA0-0030;
Nissan: 76996-01P02)
Black Nylon

Trim Panel Retainer
Head Dia: 18mm
Stem Length: 20mm
Fits Into 6mm Hole

UNIT PACKAGE: 25



20381
(Honda: 90667-671-013ZA;
Mitsubishi: MC440901;
Nissan: 62660-48600-1)
Black Nylon

Trim Panel Retaining Clip
Head Diameter: 16mm
Stem Diameter: 7mm
Stem Length: 16mm
Honda, Mitsubishi & Nissan
UNIT PACKAGE: 25



18948
(Nissan: 01553-0075U;
GM: 1644290)
Black Nylon

Hood Insulation Retainer
Head Diameter: 11mm
Stem Diameter: 5.5mm
Stem Length: 17.5mm
Altima & Maxima
2002 - On

UNIT PACKAGE: 25



16775
(Honda: 90667-SA7-0030;
Nissan: 89427-98070)
Black Nylon

Trim Panel Retainer
Head Dia: 20mm
Stem Length: 15mm
Fits Into 5mm Hole

UNIT PACKAGE: 25



14347
(Nissan: 01553-00202;
Toyota: 90467-10018)
Black Nylon

Retaining Clip
Head Diameter: 18mm
Stem Length: 12mm
Snaps Into 7mm Hole
Panel Thickness: 4mm
Nissan & Toyota
UNIT PACKAGE: 50



21519
(01553-01A50)
Black Nylon

Bumper & Trim Retainer
Head Diameter: 12mm
Stem Diameter: 6mm
Stem Length: 15mm
Infiniti FX35, G35, G37, M35,
M45 & Q45 and Nissan 350Z
& 370Z
1997 - On

UNIT PACKAGE: 25

Remember....
All Items In This
Catalog
Are Available In Bulk.

Call For A Quote



21288

(65846-4Z000)
Black Nylon

Hood Insulation Retainer
Head Diameter: 28mm
Stem Diameter: 6mm
Stem Length: 10mm
Altima
2010 - On

UNIT PACKAGE: 15



20669

(01553-07111)
Black Nylon

Trim Panel Retainer
Top Head Diameter: 13mm
Middle Head Diameter: 15mm
Bottom Head Diameter: 18mm
Stem Diameter: 9mm
Stem Length: 15mm
Nissan Altima and Infiniti G35 & Q45
1997 - On

UNIT PACKAGE: 25



20670

(01553-02821)
Gray Nylon

Trim Panel Retainer
Top Head Diameter: 13mm
Middle Head Diameter: 16mm
Bottom Head Diameter: 18mm
Stem Diameter: 8.5mm
Stem Length: 12mm
Maxima
1988 - On

UNIT PACKAGE: 15



17237

(65832-F5000,
65846-30F00)
Black Nylon

Hood Insulation Retainer
O.D.: 38mm
Stem Dia: 7mm
Stem Length: 9mm
Nissan
1981-On

UNIT PACKAGE: 15



21414

(80999-VE000)
White Nylon

Trim Panel Retainer
With Sealer
Top Head Diameter: 13mm
Middle Head Diameter: 16mm
Bottom Head Diameter: 18mm
Stem Diameter: 9mm
Stem Length: 13mm
Infiniti & Nissan
1993 - On

UNIT PACKAGE: 25



13945

(01553-S3500)
White Nylon

Door Trim
Panel Retainer
Trucks

UNIT PACKAGE: 50



20672

(66820-3S500-C1)
White Nylon

Cowl Vent Retainer
Top Head Diameter: 13mm
Bottom Head Diameter: 16mm
Stem Diameter: 4mm
Stem Length: 13mm
Frontier & Xterra
1998 - On

UNIT PACKAGE: 25



19731

(84915-0W000)
White Nylon

Trim Panel Retainer
Top Head Diameter: 13mm
Middle Head Diameter: 16mm
Bottom Head Diameter: 17mm
Stem Diameter: 9.5mm
Stem Length: 13mm
Pathfinder
1995 - On

UNIT PACKAGE: 15



18166

(80875-85E00)
Black Nylon

Trim Panel Retainer
Head Diameter: 10mm
Stem Length: 10mm
Stem Diameter: 4mm
Maxima
1989-On

UNIT PACKAGE: 25



21289

(84953-JA00A)
Yellow Nylon

Trim Panel Retainer
Top Head Diameter: 12.5mm
Middle Head Diameter: 16mm
Bottom Head Diameter: 18mm
Stem Diameter: 9.5mm
Stem Length: 14mm
Altima
2010 - On

UNIT PACKAGE: 25



20668

(01553-09791)
White Nylon

Trim Panel Retainer
Top Head Diameter: 13mm
Middle Head Diameter: 16mm
Bottom Head Diameter: 18mm
Stem Diameter: 9mm
Stem Length: 14mm
Nissan & Infiniti
1999 - On

UNIT PACKAGE: 15



21633

(80850-89900)
White Nylon

Weatherstrip Retainer
Head Size: 6mm x 16mm
Stem Diameter: 6.5mm
Stem Length: 12mm
Nissan Maxima and
Infiniti I30, I35 & M45
2004 - 2000

UNIT PACKAGE: 25



19724
(65810-K2009)
White Nylon

Hood To Cowl Seal Retainer
Head Size: 6mm x 16mm
Stem Length: 15mm
Fits Into 5mm Hole
Infiniti & Pathfinder
1992 - On
UNIT PACKAGE: 25



16859
(Nissan: 66860-01W01;
GM: 94051993)
Black Nylon

Cowl Panel To
Reinforcement Plate &
Engine Splash Shield Ret.
Head Dia: 14mm (9/16")
Stem Length: 16mm (5/8")
Fits Into 6mm (1/4") Hole
Nissan 1980-On
Geo Storm 1990-On
UNIT PACKAGE: 25



14726
(63844-01A99)
Black Nylon

Push-Type
Retainer
Head Diameter: 17mm
Stem Length: 18mm
Fits Into 8mm Hole
UNIT PACKAGE: 25



19684
(01553-09311)
Blue Nylon

Weatherstrip Retainer
Head Size: 7mm x 16mm
Stem Length: 12mm
Fits Into 6mm Hole
Altima &
Sentra
1994-On
UNIT PACKAGE: 25



14696
(Nissan: 10998-30880;
Honda: 90684-SA5-003;
Isuzu: 8942981190)
Black Nylon

Push-Type Retainer
Head Dia: 15mm
Stem Length: 11mm
Fits Into 6mm Hole
UNIT PACKAGE: 25



16784
(Nissan: 80999-05N07;
Toyota: 90467-07043)
Black Nylon

Push-Type Retainer
Head Dia: 18mm
Stem Length: 11mm
(Not Including The Pin)
Fits Into 7mm Hole
UNIT PACKAGE: 25



16783
(66824-01G00)
Black Nylon

Push-Type Retainer
Head Dia.: 12mm
Stem Length: 8mm
(Not Including The Pin)
Fits Into 6mm Hole
UNIT PACKAGE: 25



21620
(01553-06071)
Black Nylon

Rear Duct Finishing Panel
Push-Type Retainer
Head Diameter: 15mm
Stem Length: 14mm
Fits Into 5mm Hole
Cube S, SL, Krom & Leaf
2012 - On
UNIT PACKAGE: 15



20349
(Nissan: 01553-09611;
Toyota: 90467-08185)
Black Nylon

Bumper Clip
Push-Type Retainer
Head Diameter: 18mm
Stem Length: 10mm
(Not Including The Pin)
Fits Into 8mm Hole
Maxima
1994 - On
Toyota & Lexus
2002 - On
UNIT PACKAGE: 15



21159
(66820-AX020)
Black Nylon

Cowl Vent & Outside Mirror
Push-Type Retainer
Head Diameter: 14mm
Stem Length: 10mm
Fits Into 6mm Hole
Pathfinder & Versa
2005 - On
UNIT PACKAGE: 15



18265
(76882-57A00)
Black Nylon

Body Side Moulding
Push-Type Retainer
Head Diameter: 16mm
Stem Length: 20mm
Fits Into 8mm Hole
Sentra
1986-On
UNIT PACKAGE: 25



21311
(01553-0038U)
Gray Nylon

Bumper
Push-Type Retainer
Head Diameter: 18mm
Stem Length: 12mm
Fits Into 8mm Hole
Frontier, Pathfinder & Xterra
2005 - On

UNIT PACKAGE: 10



16782
(Honda:
91545-SE0-0030-W;
Nissan:
63848-01G00)
Black Nylon

Push-Type Retainer
Head Dia: 20mm
Stem Length: 8mm
(Not Including The Pin)
Fits Into 8mm Hole

UNIT PACKAGE: 25



21545
(01553-08231)
Black Nylon

Front & Rear Bumper
and Grille
Push-Type Retainer
Head Diameter: 20mm
Stem Length: 15mm
Fits Into 8mm Hole
Nissan Murano, 240 SX & 350Z
and Infiniti FX35, FX45 & Q45
1995 - On

UNIT PACKAGE: 25



19246
(01553-09241)
Black Nylon

Bumper
Push-Type Retainer
Head Diameter: 18mm
Stem Length: 15mm
Fits Into 10mm Hole
240SX & Maxima
1994-On

UNIT PACKAGE: 15



21631
(84995-3J101)
Black Nylon

Push-Type Retainer
Head Diameter: 20mm
Stem Length: 8mm
(Not Including The Pin)
Fits Into 8mm Hole
Sentra
2007 - On

UNIT PACKAGE: 15



16858
(Nissan: 63844-01A00;
Kia: MNA01-56-145;
Mazda: NA01-56-145;
Ford: MNA01-56145,
NA01-56145)
Black Nylon

Inner Fender Push-Type Retainer
Head Dia: 20mm (25/32")
Stem Length: 18mm (23/32")
Fits Into 8mm (5/16") Hole
Nissan 1980-On
Mazda, Kia & Ford

UNIT PACKAGE: 25



20613
(63848-40Y00)
Black Nylon

Front Bumper
Push-Type Retainer
Head Diameter: 18mm
Stem Length: 20mm
Fits Into 9mm Hole
Frontier & Xterra
1998 - On

UNIT PACKAGE: 15



16000
(Honda:
90675-SB3-003;
Mazda: FB01-56-964;
Nissan: 63876-95596)
Black Nylon

Push-Type Retainer
Head Dia: 20mm
Stem Length: 9mm
Fits Into 8mm Hole

UNIT PACKAGE: 25



21134
(01553-09431)
Black Nylon

Front Bumper
Push-Type Retainer
Head Diameter: 20mm
Stem Length: 11mm
(Not Including The Pin)
Fits Into 8mm Hole
Maxima
2004 - On

UNIT PACKAGE: 15



20327
(63848-9E001)
Black Nylon

Bumper Fascia
Push-Type Retainer
Head Diameter: 18mm
Stem Length: 19mm
(Not Including The Pin)
Fits Into 9mm Hole
Altima
1997 - On

UNIT PACKAGE: 10



20348
(63878-01E10)
Black Nylon

Push-Type Retainer
Head Diameter: 20mm
Stem Length: 22mm
Fits Into 8mm Hole
Maxima
1994 - On

UNIT PACKAGE: 15



19905
(01553-10051)
Black Nylon
Push-Type Retainer
Head Diameter: 20mm
Stem Length: 8mm
(Not Including The Pin)
Fits Into 8mm Hole
Maxima
1999 - On

UNIT PACKAGE: 15



19274
(01553-09321)
Black Nylon
Push-Type Retainer
Head Diameter: 20mm
Stem Length: 9mm
(Not Including The Pin)
Fits Into 8mm Hole
Maxima & 300ZX
1994-On

UNIT PACKAGE: 15



20953
(11296-AG000)
Black Nylon
Front Bumper And
Radiator Support
Push-Type Retainer
Head Diameter: 20mm
Stem Length: 13mm
(Not Including The Pin)
Fits Into 8mm Hole
Infiniti FX 35/45 and
Nissan Altima, Maxima
& Quest
2002 - On

UNIT PACKAGE: 25



17472
(Mitsubishi: MB547806;
Nissan: 63854-01A00)
Black Nylon
Front Bumper Fascia
Push-Type Retainer
Head Diameter: 20mm
Stem Length: 20mm
Fits Into 8mm Hole
300ZX
1990-On

UNIT PACKAGE: 15



17378
(01553-03101)
Black Nylon
Bumper & Fascia
Push-Type Retainer
Head Diameter: 22mm
Stem Length: 14mm
Fits Into 11mm Hole
Nissan
1986-On

UNIT PACKAGE: 15



20753
(01553-03201)
Black Nylon
Front & Rear Bumper
Push-Type Retainer
Head Diameter: 22mm
Stem Length: 21mm
Fits Into 8mm Hole
Nissan
1982 - On

UNIT PACKAGE: 10



17347
(01553-06721)
Black Nylon
Front & Rear Bumper Cover
Push-Type Retainer
Head Diameter: 20mm
Stem Length: 11mm
(Not Including The Pin)
Fits Into 8mm Hole
Maxima & Infiniti
1990-On

UNIT PACKAGE: 15



21361
(GM: 11561874;
Nissan: 622A2-9E000A)
Black Nylon
Bumper Cover
Push-Type Retainer
Head Diameter: 25mm
Stem Length: 29mm
Fits Into 7mm Hole
Chevrolet Malibu
2008 - On
Saturn Aura
2007 - On
Pontiac G6
2010 - On
Nissan Altima
1997 - On

UNIT PACKAGE: 15



16725
(66814-01G00)
Black Nylon
Cowl Grille Retainer
Head Size: 8mm x 12mm
Stem Length: 8mm
Fits Into 6mm Square Hole
Nissan Pick-Up
1986-On

UNIT PACKAGE: 25



14725
(66824-W1000)
Black Nylon
Push-Type Retainer
Head Width: 12mm
Head Length: 18mm
Stem Length: 10mm
Fits Into 6mm Hole

UNIT PACKAGE: 15



14727

(Nissan: 63844-D0100;
GM: 94221150; Isuzu: 8942211500)
Black Nylon

Push-Type Retainer
5mm x 14mm Screw
Head Size: 14mm x 22mm
Stem Length: 9mm
Fits Into 7mm Hole

UNIT PACKAGE: 25



16843

(Mazda: BF82-50-233;
Nissan: 01553-01393)
Black Nylon

Bumper Cover Retainer
Head Size: 20mm x 30mm
Stem Length: 18mm
Fits Into 10mm Hole

UNIT PACKAGE: 10



14346

(24274-M3000)
Black Nylon

Trim Ring
O.D.: 46mm
I.D.: 36mm
Fits Into 40mm Hole

UNIT PACKAGE: 25



16780

(Nissan: 99604-H1400;
Toyota: 58788-13010)
Natural Nylon

Hood Prop Rod Clip
Holds 11mm Dia. Rod
Fits Into 10mm x 12mm Hole

UNIT PACKAGE: 10



14337

(84653-N7400)
Black Nylon

Tube/Cable Routing Clip
Holds 5mm Tube or Cable
Snaps Into 5mm Hole

UNIT PACKAGE: 25



14345

(24220-89986)
White Nylon

Hood Prop Rod Clip
Holds 10mm Rod
Snaps Into 8mm Hole

UNIT PACKAGE: 10



21309

(65722-EA000)
Black Nylon

Hood Prop Rod Clip
Rod Size: 8mm
Overall Length: 33mm
Frontier, Pathfinder & Xterra
2005 - On

UNIT PACKAGE: 10



21646

(80874-AX000)
Black Nylon

Hole Plug
Head Diameter: 25mm
Fits Into 18mm Hole
Nissan Juke & Murano
and Infiniti EX35
2003 - On

UNIT PACKAGE: 25



21637

(01553-05131)
Black Nylon

Wheel Liner, Cowl Insulator
& Trim Flange Clip
Flange Diameter: 25mm
Hex: 10.5mm
Overall Height: 12.5mm
Nissan 370Z, Altima, Cube, Frontier,
GT-R, Juke, Leaf, Maxima, Murano,
NV, Pathfinder, Quest, Rouge, Versa
& Xterra and Infiniti EX35, FX35,
FX50, G25, G35, G37,
J30, M35, M45 & Q45
1993 - On

UNIT PACKAGE: 15

Not Actual Size



20380

(Not Supplied By O.E.M.)
Black Nylon

Cable Strap
Length: 200mm (8")
5mm (3/16") Wide
Max. Bundle Dia: 44mm (1-3/4")
Fits Into 6.3mm (1/4") Hole
Import Cars

UNIT PACKAGE: 25



Not Actual Size

21259

(24225-89960)
Black Nylon

Cable Strap
Overall Length: 200mm (8")
Width: 8mm (5/16")
Maximum Bundle Diameter:
55mm (2-3/16")
Snaps Into 8mm (5/16") Hole
Nissan
2005 - On

UNIT PACKAGE: 25



16340

(54229-0201P)
Cadmium & Yellow

Window Crank Handle
Retaining Clip

UNIT PACKAGE: 100



19147

(62228-51S00)

Front Bumper Retainer
300ZX
1992-On

UNIT PACKAGE: 10



21664

(63848-9Y000)
Black Nylon

Fender Apron Clip
Width: 20mm
Width At Wings: 30mm
Overall Length: 30mm
Nissan Altima, Maxima, Murano,
Pathfinder, Quest & 370Z and
Infiniti EX35, FX35, FX50, G35,
G37, M35, M37, M45 & M56
2005 - On

UNIT PACKAGE: 10



21017

(76882-0M000)
White Nylon

Nylon "U" Nut
M4.8 (#10) Screw Size
Panel Range: Up To 1.5mm
Center Of Hole To Edge: 8mm
Nissan & Infiniti
1995 - On

UNIT PACKAGE: 15



17193

(63848-D0100)
Black Nylon

Nylon "U" Nut
Fender/Wheel Housing
M5.5 (#12) Screw Size
20mm Wide, 20mm Long
Panel Range: Up to 1mm
Center Of Hole To Edge: 9mm

UNIT PACKAGE: 15



19735

(63848-35F00)
Black Nylon

Fender Clip "U" Nut
M4.8 (#10) Screw Size
20mm Wide
32mm Long
Panel Range: Up To 2mm
Center Of Hole To Edge: 8mm
Maxima & 240SX
1994 - On

UNIT PACKAGE: 15



17385

(63848-D4000)
Black Nylon

Nylon "U" Nut
Fender/Wheel Housing
M5.5 (#12) Screw Size
31mm Wide; 22mm Long
Panel Range: Up To 2mm
Center Of Hole To Edge: 9mm
Sentra

UNIT PACKAGE: 10



21459

(01241-00881)
Black Nylon

Nylon "U" Nut
With Captive Metal Hex Nut
M6 - 1.0 Thread
Center Of Hole To Edge: 14mm
Panel Range: Up To 4mm
Nissan Altima, Maxima &
240SX and Infiniti I30
2001 - 1993

UNIT PACKAGE: 10















13225

Plated

"U" Type Nut
4.2mm (#8) Screw Size
11mm Wide
16.5mm Long
Panel Range: .5mm-2.5mm
Center Of Hole To Edge: 8mm

UNIT PACKAGE: 50

Sec. 22 OPEL & RENAULT CLIPS & FASTENERS

OPEL	OPEL (Cont.)	RENAULT (Cont.)
 <p>12642 (1-74-713) Nylon Moulding Clip UNIT PACKAGE: 10</p>	 <p>13220 (Mercedes: 000-994-09-45; Volvo: 946-418; Opel: 20-72-175) Plated "U" Type Nut 6.3mm Screw Size Panel Range: .7mm-1.5mm Center of Hole To Edge: 13mm UNIT PACKAGE: 50</p>	 <p>12713 (GM: 10032838; 1264963; Chrysler: 6031869; Renault: 8934-201-602) Natural Nylon High Torque Screw Grommet UNIT PACKAGE: 25</p>
 <p>13207 (Opel 1-76-651; Renault 08-54-699-800) Nylon w/Metal Washer Body Retainer UNIT PACKAGE: 50</p>	<p style="text-align: center;">RENAULT</p>  <p>13207 (Opel: 1-76-651; Renault: 08-54-699-800) Nylon w/Metal Washer Body Retainer UNIT PACKAGE: 50</p>	 <p>13464 (8934-201-235) Natural Nylon Grille Retainer Screw Grommet 4.2mm #8 Screw Size UNIT PACKAGE: 25</p>
 <p>19153 (1-74-820, 03467-531) Nylon Moulding Clip UNIT PACKAGE: 25</p>	 <p>9377 (Renault: 8934-201-263; Chrysler: 6000943) White Nylon Radiator Grille Nut #8 Screw Size UNIT PACKAGE: 100</p>	 <p>13966 (8934-201-767) Black Nylon Tubular Barrel Nut For 3/16" Stud Barrel Length 17/64" Head Dia. 5/16" Head Thick 1/32" For Hole Dia. 17/64" UNIT PACKAGE: 100</p>
 <p>13216 Zinc "U" Type Nut 4.8mm Screw Size Panel Range: .9mm-2.0mm Center of Hole To Edge: 8mm UNIT PACKAGE: 25</p>	 <p>11855 (Renault: 8934-201-262; GM: 9669486) Natural Nylon #8 Screw Size Rear License Plate Bracket Nut AMC-Renault Side Marker Nut GM 1980-On UNIT PACKAGE: 25</p>	 <p>12993 (7703-077-066) Natural Nylon Rear Window Moulding Retainer Alliance 1983-On UNIT PACKAGE: 25</p>
		 <p>21495 (VW: 7L5-853-994) Blue Nylon Trim Panel Retainer Top Head Diameter: 13mm Bottom Head Diameter: 18mm Stem Diameter: 9mm Stem Length: 14mm Renault, VW & Audi UNIT PACKAGE: 25</p>

RENAULT (Cont.)



13475

(VW: 175-867-299;
Renault:
8934-201-681)
White Nylon

Trim Panel Retainer
Head Dia: 19mm
Stem Length: 18mm
Stem Dia: 9mm
AMC Renault 1984-On
VW 1982-On

UNIT PACKAGE: 50



13216

Zinc

"U" Type Nut
4.8mm Screw Size
Panel Range: .9mm-2mm
Center of Hole
To Edge: 8mm

UNIT PACKAGE: 25

**FasTrack Web
Auveco's Cost
Recovery System For
Repair Fasteners.....**

**Never Lose Money
On Fasteners
Again!**

SAAB



21540

(GM: 24449408)
Orange Nylon

Bumper, Grille,
Wheel Apron & Lights
Nylon Extruded "U" Nut
M5.5 (#12) Screw Size
Panel Range: Up To 2mm
Center Of Hole To Edge: 12mm

Use With Auveco 21541

Buick Lacrosse & Regal
2011 - On
Saab 9-3 & 9-5
2003 - On
Saturn Astra
2009 - 08

UNIT PACKAGE: 25

SUBARU



21581

(91059-FC030)
White Nylon

Front & Rear Door Fender,
Quarter Panel and Lift Gate
Moulding Clip
With Sealer
Top Head Size: 11mm x 14mm
Bottom Head Diameter: 17mm
Stem Length: 12mm
Fits Into 9mm Hole
B9 Tribeca, Forester, Impreza
& Outback
1998 - On

UNIT PACKAGE: 25

SUBARU (Cont.)



21564

(91059-FC110)
White Nylon

Moulding Clip
With Sealer
Head Size: 21.5mm x 24mm
Stem Diameter: 14.5mm
Stem Length: 17mm
Forester
2002 - 01

UNIT PACKAGE: 25



21572

(91059-FC090)
Black Nylon

Grille Clip
Top Head Size: 15.5mm x 11mm
Bottom Head Size: 19.5mm x 14mm
Stem Length: 11mm
Forester & Legacy
2008 - 1991

UNIT PACKAGE: 25



21562

(91017-FA080)
Gray Nylon

Grille Clip
Overall Height: 27mm
Forester Impreza & SVX
2008 - 1993

UNIT PACKAGE: 25



21579

(91167-AA000)
Black Nylon

Cowl Top, Quarter Glass,
Exterior Trim, Belt Moulding,
Trunk Lid & Rear Light
Grommet With Sealer
Head Diameter: 17.5mm
Stem Length: 15mm
Fits Into 8mm Hole
Baja, Forester, Impreza, Legacy,
Outback & SVX
2006 – 1991

UNIT PACKAGE: 25



21575

(94081-FA010)
White Nylon

Screw Grommet
M4.8 (#10) Screw Size
Head Diameter: 13mm
Stem Length: 8mm
Fits Into 8mm Square Hole
Subaru
1992 – On

UNIT PACKAGE: 25



21590

(91486-KJ000)
White Nylon

Cowl & Dash Grommet
Use With Auveco 21531
Head Diameter: 14mm
Stem Length: 7mm
Fits Into 7mm Hole
Forester, Impreza, Legacy &
Outback
2008 – On

UNIT PACKAGE: 25



21587

(62731-FA010)
Blue Nylon

M3.5 (#6) Screw Size
Head Size: 11mm x 11mm
Stem Length: 10mm
Fits Into 8mm x 8mm Square Hole
Subaru
1993 – On

UNIT PACKAGE: 25



21569

(909300015)
White Nylon

Rear Bumper
Screw Grommet
M4.8 (#10) Screw Size
Head Diameter: 12mm
Stem Length: 15mm
Fits Into 7mm Square Hole
Impreza, Legacy, Outback & SVX
2009 – 1995

UNIT PACKAGE: 25



21531

(91486-KJ010)
Black Nylon

Cowl Panel Vent Cap
Top Head Size: 16mm x 18mm
Bottom Head Diameter: 14mm
Stem Length: 12mm
Forester, Impreza, Legacy, Outback
& WRX
2008 – On

UNIT PACKAGE: 15



21629

(62731-FA000)
White Nylon

M3.5 (#6) Screw Size
Head Size: 10mm x 10mm
Stem Length: 5mm
Fits Into 7mm x 7mm Hole
Forester, Impreza, Legacy &
Outback
2009 – 05

UNIT PACKAGE: 25



21577

(57750-FC010)
White Nylon

Rear Bumper Reinforcement Beam
Screw Grommet
With Sealer
M4.8 (#10) Screw Size
Head Size: 16mm x 16mm
Stem Length: 19mm
Forester
2008 – 1998

UNIT PACKAGE: 25



21573

(90331-GA090)
Black Nylon

Weatherstrip Retaining Clip
Head Diameter: 9mm
Stem Diameter: 6.5mm
Stem Length: 13mm
Forester & Legacy
2008 – 1990

UNIT PACKAGE: 25

SUBARU CLIPS & FASTENERS

Sec. 22



21589

(99045-AE03AMA)
Black Nylon

Trim Panel Retainer
Head Diameter: 18mm
Stem Diameter: 7.7mm
Stem Length: 15mm
B9 Tribeca, Impreza, Legacy
& Outback
2005 - On

UNIT PACKAGE: 25



21421

(90913-0074)
Black Nylon

Hood Insulation Retainer
Head Diameter: 30mm
Stem Diameter: 7.7mm
Stem Length: 13mm
Baja, Forester, Impreza,
Legacy, Outback & Tribeca
1998 - On

UNIT PACKAGE: 15



21574

(90913-0034)
White Nylon

Door, Pillar, Rocker, Floor &
Interior Trim Retainer
Top Head Diameter: 13mm
Middle Head Diameter: 16mm
Bottom Head Diameter: 15mm
Stem Diameter: 9.5mm
Stem Length: 11mm
Baja, Forester, Legacy & Outback
2008 - 03

UNIT PACKAGE: 25



21630

(95022-AC040ML)
Black Nylon

Headliner & Trim
Space Retainer
Head Diameter: 20mm
Stem Diameter: 6mm
Stem Length: 22mm
Forester, Impreza, Legacy
& Outback
1998 - On

UNIT PACKAGE: 25



21591

(90913-0109)
Black Nylon

Front & Rear Door, Fender,
Quarter Panel and Rocker Panel
Moulding Clip
Top Head Size: 11mm x 14mm
Bottom Head Diameter: 17mm
Stem Diameter: 9.7mm
Stem Length: 12mm
B9 Tribeca, Forester, Impreza,
Legacy & Outback
2003 - On

UNIT PACKAGE: 25



21502

(90913-0213)
White Nylon

Door Trim Panel Retainer
With Sealer
Top Head Diameter: 13mm
Middle Head Diameter: 16mm
Bottom Head Diameter: 15mm
Stem Diameter: 9.5mm
Stem Length: 14mm
Legacy & Outback
2010 - On

UNIT PACKAGE: 10



21322

(90814-FC001)
Black Nylon

Retainer
Head Diameter: 30mm
Stem Diameter: 6.5mm
Stem Length: 13mm
Subaru
1998 - On

UNIT PACKAGE: 10



21567

(90913-0007)
Gray Nylon

Pillar & Door Moulding Trim
and Rear Light Retainer
With Sealer
Top Head Size: 11mm x 15mm
Bottom Head Diameter: 18mm
Stem Diameter: 9.7mm
Stem Length: 12mm
B9 Tribeca, Forester, Impreza,
Legacy & Outback
2005 - On

UNIT PACKAGE: 25



21584

(69300-5370)
White Nylon

Front Door & Lift Gate
Trim Panel Retainer
Top Head Diameter: 13mm
Middle Head Diameter: 16mm
Bottom Head Diameter: 18mm
Stem Diameter: 9.3mm
Stem Length: 10mm
Impreza, Justy, Legacy & Outback
2007 - 1987

UNIT PACKAGE: 25



21565
(90331-AA050)
White Nylon

Weatherstrip Retaining Clip
Head Size: 5mm x 14mm
Stem Diameter: 7mm
Stem Length: 8.5mm
Forester
2008 – 03

UNIT PACKAGE: 25



21570
(90914-0012)
Black Nylon

Rear Light Reflector &
Roof Spoiler
Push-Type Retainer
Head Diameter: 16mm
Stem Length: 11mm
Fits Into 6mm Hole
B9 Tribeca, Impreza, Legacy
& Outback
2005 – On

UNIT PACKAGE: 25



21422
(90914-0051)
Black Nylon

Front Bumper & Quarter Panel
Push-Type Retainer
Head Diameter: 20mm
Stem Length: 9mm
Fits Into 7mm Hole
B9 Tribeca, Impreza,
Legacy & Outback
2005 – On

UNIT PACKAGE: 15



21585
(90913-0003)
Black Nylon

Upper Grille
Push-Type Retainer
Head Diameter: 9mm
Stem Length: 7mm
Fits Into 4mm Hole
Baja, Legacy & Outback
2006 – 2000

UNIT PACKAGE: 25



21566
(91085-TA030)
Black Nylon

Push-Type Retainer
Head Diameter: 16mm
Stem Length: 13mm
Fits Into 7mm Hole
Baja, Impreza, Legacy
& Outback
2000 – On

UNIT PACKAGE: 25



21571
(59122-FA010)
Black Nylon

Front Bumper, Fender,
Windshield Washer &
Rocker Moulding
Push-Type Retainer
Head Diameter: 20mm
Stem Length: 10mm
Fits Into 8mm Hole
B9 Tribeca, Baja, Forester,
Impreza, Legacy & Outback
1998 – On

UNIT PACKAGE: 25



21593
(46064-AE000)
Black Nylon

Front Fender Bumper
& Quarter Panel
Push-Type Retainer
Head Diameter: 15mm
Stem Length: 8mm
Fits Into 7mm Hole
Baja, Forester, Impreza,
Legacy & Outback
2003 – On

UNIT PACKAGE: 10



21530
(90913-0067)
Black Nylon

Engine Cover and Fender Liner
Push-Type Retainer
Head Diameter: 18mm
Stem Length: 10mm
Fits Into 8mm Hole
B9 Tribeca, Forester,
Legacy & Outback
& Tribeca
2005 – On

UNIT PACKAGE: 15



21592
(90914-0052)
Black Nylon

Push-Type Retainer
Head Diameter: 20mm
Stem Length: 11mm
Fits Into 7mm Hole
B9 Tribeca, Impreza, Legacy
& Outback
2005 – On

UNIT PACKAGE: 15



21594

(90913-0051)
Black Nylon

Fender Liner, Duct &
Lower Moulding
Push-Type Retainer
Head Diameter: 20mm
Stem Length: 11mm
Fits Into 7mm Hole
B9 Tribeca, Forester, Impreza,
Legacy & Outback
2005 – On

UNIT PACKAGE: 15



21563

(90913-0059)
Black Nylon

Front Bumper & Fender
Push-Type Retainer
Head Diameter: 20mm
Stem Length: 15mm
Fits Into 10mm Hole
Forester, Impreza, & Outback
2006 – 02

UNIT PACKAGE: 25



21501

(90914-0055)
Black Nylon

Push-Type Retainer
With Sealer
Head Diameter: 25mm
Shoulder Length: 3mm
Shoulder Diameter: 16.5mm
Stem Length: 12mm
Fits Into 11mm Hole
Subaru
2006 – On

UNIT PACKAGE: 5



21580

(59122-AC030)
Black Nylon

Front Fender
Push-Type Retainer
Head Diameter: 20mm
Stem Length: 12mm
Fits Into 7mm Hole
B9 Tribeca, Baja, Forester,
Legacy & Outback
1995 – On

UNIT PACKAGE: 25



21420

(90914-0007)
Black Nylon

Bumper, Engine Cover,
Fender & Grille
Push-Type Retainer
Head Diameter: 21mm
Stem Length: 15mm
Fits Into 10mm
B9 Tribeca, Baja, Forester, Impreza,
Legacy & Outback
2000 – On

UNIT PACKAGE: 15



21576

(90914-0002)
Black Nylon

Rocker, Pillar, Floor &
Exterior Trim
Push-Type Retainer
With Sealer
Head Diameter: 25mm
Shoulder Diameter: 17mm
Shoulder Length: 3mm
Stem Length: 14mm
Fits Into 11mm Hole
B9 Tribeca, Baja, Legacy
& Outback
2000 – On

UNIT PACKAGE: 25



21500

(90914-0063)
Black Nylon

Cowl Vent
Push-Type Retainer
Head Diameter: 20mm
Stem Length: 12mm
Fits Into 7mm Hole
Legacy & Outback
2010 - On

UNIT PACKAGE: 10



21578

(57750-AA090)
Black Nylon

Front & Rear Bumper
Push-Type Retainer
Head Diameter: 22mm
Stem Length: 28mm
Fits Into 10mm Hole
Impreza & Legacy
2001 – 1993

UNIT PACKAGE: 25



21568

(57160-FC000)
Black Nylon

Front Fender
Push-Type Retainer
Top Head Length: 19.5mm
Bottom Head Diameter: 14mm
Stem Length: 15mm
Fits Into 10mm Hole
Forester
2008 – 1998

UNIT PACKAGE: 25

SUZUKI



20743
(77553-65D00)
White Nylon

Moulding Clip
Head Diameter: 18mm
Stem Length: 9mm
Overall Length: 18mm
Suzuki

UNIT PACKAGE: 10



20744
(77259-71B00)
White Nylon

Moulding Clip
With Sealer
Top Head Diameter: 13mm
Bottom Head Diameter: 16mm
Stem Length: 13mm
Suzuki

UNIT PACKAGE: 10



17383
(GM: 94847334, 96057847;
Toyota: 90467-07066;
Suzuki: 09409-07313)
Black Nylon

Radiator Grille
& Trim Panel
Push-Type Retainer
Head Diameter: 11mm
Stem Length: 14mm
(Excluding The Pin)
Fits Into 7mm Hole
Suzuki and Geo Tracker & Prizm
1992 - 89

UNIT PACKAGE: 10



20908
(Suzuki: 09409-07332;
Toyota: 90467-07164)
Black Nylon

Push-Type Retainer
Head Diameter: 20mm
Stem Length: 10mm
Fits Into 7mm Hole
Suzuki
1999 - On
Toyota
1997 - On

UNIT PACKAGE: 10

TOYOTA



16691
Natural Nylon

Headlight Adjusting
Screw Nut

Pick-Up Truck
1984-On

UNIT PACKAGE: 25



18747
(90189-06162)
Natural Nylon

Front Clearance Lamp Nut
Camry 1994-91
Headlight Adjusting Nut
Lexus

UNIT PACKAGE: 10



16558
(81121-14670)

Headlight Adjusting Spring

UNIT PACKAGE: 5



16951
(81124-89101)
Nylon

Headlight Spacer
15mm Wide x 18mm Long
Fits Into 7mm Square Hole
Pick-Up Truck
1984-On

UNIT PACKAGE: 25



20738
(53271-44010)
Black Nylon

Headlight Bracket Clip
25mm Wide, 40.5mm Long
Toyota Camry & RAV 4
And Lexus IS-300
2001 - On

UNIT PACKAGE: 4



21369

(67771-58010)
White Nylon

Door & Garnish
Moulding Clip
Overall Height: 12.4mm (1/2")
Tundra
2007 - On

UNIT PACKAGE: 25



21546

(90467-09204)
White Nylon

Rear Hatch Door Side Garnish
and Front Body Pillar Garnish
Moulding Clip
Overall Height: 14mm
Toyota Camry, Highlander, Prius
& Sienna and Lexus GS 300,
GS 400, GS 430, GX 470, RX 330,
RX 350, RX 400 & RX 450
1998 - On

UNIT PACKAGE: 25



21549

(90467-12080)
Pink Nylon

Door Trim, Instrument Panel,
Rear Deck Trim &
Roof Garnish Trim
Moulding Clip
Overall Height: 21mm
Toyota Avalon, Camry, Corolla,
Echo, FJ Cruiser, Highlander,
Matrix, Prius,
RAV 4, Sequoia, Sienna, Tacoma,
Tundra, Venza, Yaris & 4-Runner and
Lexus ES 350, GX 460, RX 330
& RX 450h
2000 - On

UNIT PACKAGE: 25



17194

(90467-13005)
Black Nylon

Grille Clip
13mm Wide
23mm Long

UNIT PACKAGE: 25



21623

(Mitsubishi: MR221507;
Toyota: 90467-13075)
Gray Nylon

Radiator Grille Clip
Width: 14mm
Length: 24mm
Mitsubishi Diamante,
Endeavor & Galant
1997 - On
Toyota 4 Runner, Highlander
& Land Cruiser
1998 - On

UNIT PACKAGE: 25



17438

(90467-17004)
Black Nylon

Radiator
Grille Clip
21mm Wide
22mm Long
Cressida
1987-84

UNIT PACKAGE: 10



19430

(90904-67021)
Black Nylon

Radiator Grille Retainer
T-100 Truck
1992-On

UNIT PACKAGE: 15



21194

(61118-35010)
Black Nylon

Front Fender Upper Seal
Moulding Clip
Head Size: 18mm x 18mm
Stem Length: 13mm
Fits Into 9mm Hole
FJ Cruiser
2007 - On

UNIT PACKAGE: 15



15695

(Toyota: 62955-20020;
GM: 94848834)
White Nylon

Moulding Clip With Sealer
Head Dia: 15mm
Stem Length: 9mm
Fits Into 8mm Hole
Toyota Pick-Up Truck
Pontiac Vibe

UNIT PACKAGE: 25



21453

(75395-0T010)
White Nylon

Moulding Clip
With Sealer
Top Head Size: 5mm x 10mm
Bottom Head Diameter: 18mm
Stem Diameter: 10mm
Stem Length: 13mm
Corolla & Venza
2008 - On

UNIT PACKAGE: 25



19647
(90467-11111)
Red Nylon

Scuff Plate Retainer
Head Diameter: 18mm
Stem Diameter: 10mm
Stem Length: 10mm
Sienna
1997-On

UNIT PACKAGE: 10



21550
(90467-11099)
White Nylon

Hood and Front & Rear Side
Moulding Clip
Head Diameter: 17mm
Stem Length: 8.5mm
Fits Into 9mm Square Hole
Tundra & 4-Runner
2006 - 1996

UNIT PACKAGE: 25



20391
(90904-67037)
Red Nylon

Fender Moulding Clip
Head Diameter: 17mm
Stem Length: 13mm
Highlander, Land Cruiser,
Tacoma & Tundra
2001 - On

UNIT PACKAGE: 10



21653
(75867-AC020)
White Nylon

Moulding Clip
With Sealer
Head Diameter: 18mm
Stem Length: 13mm
Fits Into 8mm Hole
Avalon
2005 - On

UNIT PACKAGE: 15



20687
(75396-35020,
75495-35010)
Blue Nylon

Rocker Moulding Clip
With Sealer
Head Diameter: 17mm
Stem Length: 10mm
4-Runner
2003 - On

UNIT PACKAGE: 10



20688
(75397-35010)
Orange Nylon

Wheel Flare Moulding Clip
With Sealer
Head Diameter: 17mm
Stem Length: 17mm
4-Runner
2003 - On

UNIT PACKAGE: 10



17481
(90467-11063)
White Nylon

Rocker Panel
Moulding Clip
With Sealer
Head Dia: 18mm
Stem Length: 9mm
Previa
1990-On

UNIT PACKAGE: 15



20429
(90467-11100)
Yellow Nylon

Fender & Wheel Flare
Moulding Clip
Head Dia: 17mm
Stem Length: 17mm
Highlander, Land Cruiser,
Tacoma & Tundra
2000 - On

UNIT PACKAGE: 10



19797
(90467-10077)
Butterscotch Nylon

Door Moulding Clip
With Sealer
Head Diameter: 15mm
Stem Length: 9mm
Fits Into 8mm Hole
Avalon & Corolla
1998 - On

UNIT PACKAGE: 15



20390
(90904-67036)
Blue Nylon

Fender Moulding Clip
Head Diameter: 17mm
Stem Length: 17mm
Highlander, Land Cruiser,
Tacoma & Tundra
2001 - On

UNIT PACKAGE: 10



19843
(75498-42010)
White Nylon

Garnish Clip
Head Diameter: 20mm
Stem Length: 20mm
RAV 4
1996 - On

UNIT PACKAGE: 10



21612
(76817-12060)
White Nylon

Rear Door, Hatch Garnish and Luggage Compartment Moulding Clip With Sealer
Large Head Diameter: 24mm
Overall Length: 24mm
Camry, Corolla & Matrix
2003 - On

UNIT PACKAGE: 15



20578
(GM: 88970495, 88973654;
Toyota: 76924-52021)
Black Nylon

Rocker Moulding Retainer
Head Diameter: 32mm
Stem Length: 10mm
Fits Into 22mm Hole
Pontiac Vibe & Toyota Corolla
2003 - On

UNIT PACKAGE: 25



14264
(75395-14020-A)
Nylon

Moulding Clip
28mm Wide, 14mm Long
Snaps Into 7mm Hole

UNIT PACKAGE: 25



21008
(75791-33020)
Black Nylon

Front & Rear Belt Moulding Clip
Width: 14mm
Overall Height: 10mm
Camry
2000 - 1997

UNIT PACKAGE: 15



21071
(90084-46020)
White Nylon

Bumper Cover Clip
Head Size: 21mm x 30mm
Stem Length: 12mm
Camry
2005 - On

UNIT PACKAGE: 10



21641
(90467-12073)
White Nylon

Rocker Moulding Clip
Head Size: 23mm x 28mm
Stem Length: 14mm
Fits Into 10mm x 10mm Hole
Land Cruiser
2007 - 1998

UNIT PACKAGE: 15



19531
(68211-06020)
Natural Nylon

Door Belt Moulding Clip
Solara
1998-On

UNIT PACKAGE: 25



19380
(68211-07010)
Natural Nylon

Door Belt Moulding Clip
Avalon
1994-On

UNIT PACKAGE: 25



19198
(68211-32040)
Yellow Nylon

Door Belt Moulding & Door Weatherstrip Clip
Camry
1991-On

UNIT PACKAGE: 50

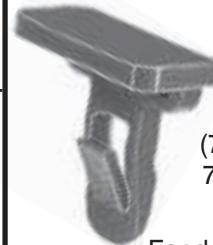

21016
(75392-35200,
75392-04010)
Blue Nylon

Fender Flare & Bumper Clip
Head Size: 13mm x 26mm
Stem Length: 24mm
Toyota Camry, FJ,
RAV 4 & Tacoma
2005 - On

UNIT PACKAGE: 15



21586
(76853-10010)
White Nylon

Front & Rear Bumper Clip
Head Size: 13mm x 26mm
Stem Length: 25mm
Matrix
2008 - 03

UNIT PACKAGE: 25



21642
(90467-12075)
Yellow Nylon

Rocker Moulding Clip
Top Head Size: 11mm x 13mm
Bottom Head Size: 15mm x 25mm
Stem Length: 14mm
Fits Into 10mm x 10mm Hole
Land Cruiser
2007 – 1998

UNIT PACKAGE: 15

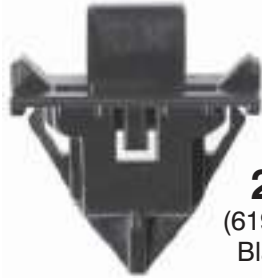

21235
(61992-35010)
Black Nylon

Front Fender/Sheet Metal
Upper Seal
Moulding Clip
Top Head Size: 13mm x 31mm
Overall Height: 34mm
FJ Cruiser
2007 – On

UNIT PACKAGE: 10



21221
(52115-0C090)
Black Nylon

Front Bumper
Moulding Clip
Head Size: 25mm x 74mm
Overall Height: 17mm
Stem Length: 15mm
Tundra
2009 – On

UNIT PACKAGE: 10



21133
(52197-52010)
Black Nylon

Front Bumper
Moulding Clip
With Sealer
Overall Width: 30mm
Overall Height: 25mm
Stem Length: 13mm
Highlander
2001 – On

UNIT PACKAGE: 10



21132
(52115-48040)
Gray Nylon

Front Bumper
Moulding Clip
Overall Length: 47mm
Stem Length: 8mm
Highlander
2001 – On

UNIT PACKAGE: 10



21162
(53935-35020)
Black Nylon

Bumper Filler Clip
Overall Length: 30mm
Overall Height: 17mm
4 Runner
2003 – On

UNIT PACKAGE: 10



21234
(61991-35010)
Black Nylon

Front Fender/Sheet Metal
Upper Seal
Moulding Clip
Top Head Size: 9mm x 31mm
Overall Height: 30mm
FJ Cruiser
2007 – On

UNIT PACKAGE: 10



21217
(76924-47010)
Black Nylon

Rocker Panel
Moulding Clip
Head Size: 43mm x 54mm
Overall Height: 26mm
Prius
2009 – On

UNIT PACKAGE: 5



16800

M6-1.0 x 20mm
License Plate Hardware
Includes Nylon Screw,
Washer & Spacer And Brass Nut

UNIT PACKAGE: 25 Sets



17636

Nylon

License Plate
Bracket Spacer
1/4" (6mm) I.D.
3/4" (19mm) O.D.
1/4" (6mm) Thick

UNIT PACKAGE: 50



19722

(68211-95D00)

White Nylon

Door Glass Clip
Previa Van
1990 - On

UNIT PACKAGE: 15

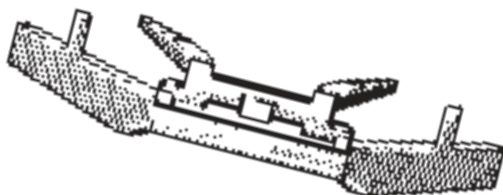

16833

(75545-32020)

Nylon

Windshield Moulding Clip
12mm Wide, 66mm Long
Camry
1987-On

UNIT PACKAGE: 10

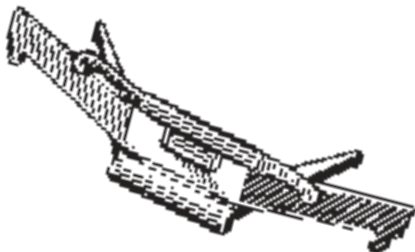

15475

(75545-12050)

White Nylon

Windshield Moulding Clip
22mm Wide, 56mm Long
19mm High
Corolla (RWD)
1984-On

UNIT PACKAGE: 10



19204

(75546-12060)

Natural Nylon

Windshield Moulding Clip
Corolla Sedan Wagon
1992-88

UNIT PACKAGE: 25



17302

(75545-89103)

Natural Nylon

Windshield Side Moulding Clip
Without Center Tab
Truck
1988-On

UNIT PACKAGE: 15

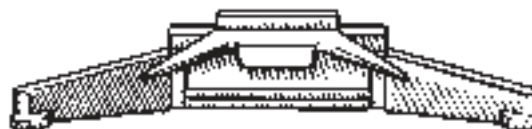

17334

(75546-22060)

Natural Nylon

Windshield Side Moulding Clip
Cressida
1988-On

UNIT PACKAGE: 15



17485

(75545-32030)

Natural Nylon

Windshield Moulding Clip
Camry
1992-On

UNIT PACKAGE: 15



14746
(75546-12050)
Nylon

Windshield Moulding Clip
20mm Wide
41mm Long
Fits Into 8mm Hole
UNIT PACKAGE: 15



17330
(75548-16010)
Nylon

Windshield Moulding Clip
With Adhesive Backing
14.5mm Wide, 71mm Long
Corolla
1988-83

UNIT PACKAGE: 15



17298
(75547-22010)
Black Nylon

Windshield Moulding Clip
20mm Wide, 47mm Long
1981-On

UNIT PACKAGE: 25



19484
(75548-22150)
Blue Nylon

Windshield Moulding Clip
With Adhesive Backing
9mm Wide, 40mm Long
Cressida
1988-On

UNIT PACKAGE: 10



14278
(75548-24020)
Nylon

Windshield Clip
With Adhesive Backing
14.5mm Wide
60mm Long

UNIT PACKAGE: 10



14745
(75546-22050)
Nylon

Windshield Moulding Clip
14mm Wide
47mm Long
12mm High

UNIT PACKAGE: 25



14731
(75548-32010)
Nylon

Windshield Clip
With Adhesive Backing
14.5mm Wide
70mm Long

UNIT PACKAGE: 25



14751
(75545-16020)
Nylon

Windshield Moulding Clip
18mm Wide
49mm Long
13mm High

UNIT PACKAGE: 25

Note: If an adhesion problem occurs with the adhesive backed clips, warm the back with a heat gun.



14749

(75545-88080;
75545-28010-B)

Nylon

Windshield Moulding Clip
18mm Wide
49mm Long
16mm High

UNIT PACKAGE: 25



16942

(75545-89101)

Nylon

Windshield Moulding Clip
15mm Wide, 47mm Long
13mm High
Pick-Up Truck
1984-On

UNIT PACKAGE: 15



14271

(90189-04011)

Natural Nylon

#6 Screw Size
12mm Wide, 12mm Long
Snaps Into 7mm x 7.5mm Hole

UNIT PACKAGE: 25



19504

(90189-04211)

White Nylon

Front Door Moulding
Nylon Nut
#6 Screw Size
T100 Truck
1992-On

UNIT PACKAGE: 20



14747

(75545-14081)

Nylon

Windshield Moulding Clip
18mm Wide
50mm Long
15mm High

UNIT PACKAGE: 25



17224

(90189-04022,
95900-04036)

Nylon

#6 Screw Size
10mm Wide, 10mm Long
Snaps Into 7mm x 7mm Hole

UNIT PACKAGE: 50



21628

(81137-22530,
81150-1A750,
90075-10004)

White Nylon

M3.5 (#6) Screw Size
Head Size: 10mm x 10mm
Stem Length: 7mm
Fits Into 7mm x 7mm Hole
Avalon, Camry, Land Cruiser,
Tacoma & Tundra
2007 - 1992

UNIT PACKAGE: 25



16821

(75546-12030)

Nylon

Windshield Moulding Clip
21mm Wide, 54mm Long
15mm High
Corolla
1984-On

UNIT PACKAGE: 25

Please E-Mail
Your New Item
Suggestions

To

mail@auveco.com



14256

(90189-04014)

Natural Nylon

#8 Screw Size
10mm Wide, 10mm Long
Snaps Into 7mm x 7mm Hole

UNIT PACKAGE: 50



13932

(Toyota: 90189-05013;
Mitsubishi: MS-480002)

Natural Nylon

#10 Screw Size
12mm Wide, 12mm Long
Fits Into 8mm x 9mm Hole

UNIT PACKAGE: 50



14274

(Toyota: 90189-06010;
Honda: 75521-611-0000;
Mazda: 9991-00-601;
Nissan: 96706-P0105)
Natural Nylon

#10 Screw Size
13mm Wide, 13mm Long
Snaps Into 8.5mm x 8.5mm Hole

UNIT PACKAGE: 25



14258

(90189-06018)
Black Nylon

#10 Screw Size
14mm Wide
14mm Long
Snaps Into 9mm x 9mm Hole

UNIT PACKAGE: 25



20895

(90189-06193)
Natural Nylon

Front Bumper Nylon Nut
Use With M5.5 (#12) Screw
Head Size: 14mm x 16mm
Stem Length: 10mm
Avalon & Camry
2002 - On

UNIT PACKAGE: 25



14739

(Toyota: 90189-05012;
Isuzu: 8941340270)
Natural Nylon

#6 Screw Size
16mm Wide
12mm Long
Snaps Into 6mm x 10mm Hole

UNIT PACKAGE: 50



21151

(90189-04059)
White Nylon

Rocker, Pillar, Floor &
Exterior Trim
Screw Grommet
M3.5 (#6) Screw Size
Head Size: 12mm x 18mm
Stem Length: 7mm
Toyota Scion, Avalon & FJ Cruiser
and Lexus ES300, ES330, RX330,
RX400, SC300, SC400
1992 - On

UNIT PACKAGE: 25



20442

(90189-04127)
Natural Nylon

Door Panel Nylon Nut
M3.5 (#6) Screw Size
Head Size: 14mm x 14mm
Stem Length: 15mm
Toyota Tundra
1999 - On

UNIT PACKAGE: 25



19840

(90189-04176)
Natural Nylon

Mudguard Screw Grommet
#8 (M4.2 - 1.41) Screw Size
Head Size: 10mm x 10mm
Stem Length: 15mm
Corolla
1997 - On

UNIT PACKAGE: 15



19265

(90189-04150)
White Nylon

Windshield Moulding
Screw Grommet
#4 Screw Size
T100
1992-On

UNIT PACKAGE: 15



21544

(90189-04102)
White Nylon

Screw Grommet
With Sealer
M3.2 (#6) Screw Size
Head Size: 10mm x 10mm
Stem Length: 15mm
Fits Into 7mm Square Hole
Toyota Highlander and
Lexus IS 250, IS 350, & IS F
2006 - On

UNIT PACKAGE: 25



19783

(Ford: N811169-S,
W705550-S300;
Toyota: 90075-10801,
90189-06111)
White Nylon

Head Diameter: 13mm
Stem Length: 9mm
Fits Into 11mm Hole
Ford, Lexus & Toyota

UNIT PACKAGE: 50



14277

(90189-04008,
90467-12096)
Black Nylon

Screw Grommet
#8 Screw Size
15mm High
12mm Wide
16mm Long
Fits Into 10mm x 10mm Hole

UNIT PACKAGE: 15



20431

(90189-05105)
Natural Nylon

Front Fender Flare
Screw Grommet
Use With M4.2 (#8) Screw
Head Size: 10mm x 15mm
Stem Length: 12mm
RAV 4
1996 - On

UNIT PACKAGE: 15



18843

(90189-04031)
Natural Nylon

Grille & Rear Filler Nut
#8 Screw Size
Camry & RAV4
2000 - 1991

UNIT PACKAGE: 25



18846
(53145-16020)
Black Nylon
Radiator Grille
Garnish Grommet
Tercel
1990-On

UNIT PACKAGE: 10



14263
(90189-04019)
Natural Nylon
#8 Screw Size
12mm Wide, 14mm Long
Fits Into 6.5mm x 8.5mm Hole

UNIT PACKAGE: 25



19841
(55799-12010)
Blue Nylon
Cowl Screw Grommet
#10 (M4.8) Screw Size
Fits Into 10mm x 15mm Hole
Toyota Celica & Corolla
1997 - On

UNIT PACKAGE: 10



21015
(52535-50060,
52535-0E010)
Black Nylon
Front Bumper
Screw Grommet
M5.5 - M6 (#12) Screw Size
Head Size: 17mm x 30mm
Stem Length: 9mm
Lexus IS250, IS350,
RX330 & RX350 and
Toyota Camry, Highlander
& Tacoma
2001 - On

UNIT PACKAGE: 5



21583
(52535-30150)
White Nylon
Front & Rear Bumper
Screw Grommet
M5.5 (#12) Screw Size
Head Size: 17.5mm x 30mm
Stem Length: 10mm
Toyota Avalon, Sequoia &
Tundra and Lexus ES300, 330,
350, LS430 & RX300
1999 - On

UNIT PACKAGE: 25



14265
(90189-06006)
Natural Nylon
M4.8 (#10) Screw Size
Head Diameter: 17mm
Fits Into 9mm x 9mm Hole

UNIT PACKAGE: 25



21331
(90189-06211)
Black Nylon
Pillar, Rocker and Floor
Screw Grommet
M5.5 (#12) Screw Size
Head Diameter: 17mm
Stem Length: 10mm
Fits Into 9mm Square Hole
Camry
2010 - On

UNIT PACKAGE: 25



21191
(90189-05142)
Natural Nylon
Headlight Mounting
Nylon Nut
M4.2 (#8) Screw Size
Head Diameter: 17mm
Stem Length: 8mm
Fits Into 9mm Square Hole
Toyota & Scion
2001 - On

UNIT PACKAGE: 25



19187
(90189-05082)
Natural Nylon
Hood Seal To Cowl Top
Screw Grommet
#6 Screw Size
Head Diameter: 13mm
Stem Length: 13mm
Fits Into 7mm x 7mm Hole
2WD & 4WD Truck
1988-On

UNIT PACKAGE: 15



14268
(Toyota: 90189-04013;
Honda:
90672-671-8110M1)
Natural Nylon
#6 Screw Size
Head Diameter: 14mm
Stem Length: 15mm
Fits Into 7mm x 7mm Hole

UNIT PACKAGE: 25



14695
(Toyota: 90189-06042;
Honda: 90661-SC7-0030;
Mazda: H001-50-841;
Mitsubishi: MS-480012;
Nissan: 01651-00481,
74798-S9000)
White Nylon
Screw Grommet
#8 Screw Size
Head Diameter: 16mm
Stem Length: 17mm
Fits Into 8mm x 8mm Hole

UNIT PACKAGE: 25



14275
(Toyota: 90189-06001;
Mitsubishi: MB-098145;
Nissan: 01281-00023,
01281-00231)
White Nylon
Screw Grommet
M4.8 (#10) Screw Size
Head Diameter: 18mm
Stem Length: 17mm
Fits into 8.5mm x 8.5mm Hole

UNIT PACKAGE: 25



14281

(Honda: 90662-693-0030;
Toyota: 90189-04066)
White Nylon

Screw Grommet
#6 Screw Size
Head Diameter: 14mm
Stem Length: 10mm
Fits Into 7mm x 7mm Hole

UNIT PACKAGE: 25



19505

(90189-06029,
90189-06084,
90189-06116)
Natural Nylon

Rear Door Panel
Screw Grommet
#12 Screw Size
Head Diameter: 18mm
Stem Length: 17mm
Fits Into 9mm x 9mm Hole
Camry & Previa
1988 - On

UNIT PACKAGE: 10



19742

(90189-06104)
Natural Nylon

Fender Lining
Screw Grommet
#12 (M5.5) Screw Size
Head Diameter: 18mm
Stem Length: 15mm
Fits Into a 9mm Square Hole
Lexus IS300 & Toyota Avalon,
Camry & Sienna
1997-On

UNIT PACKAGE: 15



21625

(90189-06145)
Black Nylon

Fender Lining
Screw Grommet
M5.5 (#12) Screw Size
Head Diameter: 16mm
Stem Length: 16mm
Fits Into 9mm x 9mm Hole
Toyota Prius, Sequoia & T-100
and Lexus CT 200h
1993 - On

UNIT PACKAGE: 15



19194

(Toyota: 90189-06028;
GM: 94854203)
Black Nylon

Front & Rear Wheel
Fender Liner Screw Grommet
#12 Screw Size
Head Diameter: 16mm
Stem Length: 19mm
Fits Into 9mm x 9mm Hole
Tacoma, T100 & 4 Runner
1992-On
Chevrolet Nova & Prizm
And Pontiac Vibe
1985-On

UNIT PACKAGE: 15



19756

(90189-06214)
Black Nylon

Fender Liner
Screw Grommet
#12 (M5.5) Screw Size
Head Diameter: 16mm
Stem Length: 18mm
Sienna, Tacoma & Tundra Pick-Up
1999 - On

UNIT PACKAGE: 15



21605

(90189-A0002)
Black Nylon

Screw Grommet
M5.5 (#12) Screw Size
Head Diameter: 20mm
Stem Length: 17mm
Fits Into 9mm x 9mm Hole
Toyota Avalon, Corolla,
FJ Cruiser, RAV4, Sienna,
Tacoma & 4Runner and Lexus
GX460, GX470 & LX570
1995 - On

UNIT PACKAGE: 25



20440

(90189-06065)
Black Nylon

Hood & Fender
Screw Grommet
M5.5 (#12) Screw Size
Head Diameter: 20mm
Stem Length: 18mm
Fits Into 9mm x 9mm Hole
Camry & RAV 4
1999 - 95

UNIT PACKAGE: 15



19721

(90189-06157)
Black Nylon

Fender Lining
Screw Grommet
M5.5 (#12) Screw Size
Head Diameter: 20mm
Stem Length: 22mm
Fits Into 8mm x 8mm Hole
Avalon, Camry, RAV4, Solara
& Tacoma
1995-On

UNIT PACKAGE: 15



21411
(90189-06177)
Black Nylon

Rocker Moulding
Screw Grommet
M5.5. (#12) Screw Size
Head Diameter: 20mm
Stem Length: 22mm
Fits Into 9mm x 9mm Hole
Camry
2010 - On

UNIT PACKAGE: 15



20412
(90189-06114)
White Nylon

Front Fender Liner
Screw Grommet
M5.5 (#12) Screw Size
Head Dia: 18mm
Stem Length: 15mm
Fits Into 9mm Sq. Hole
RAV4
1996 - On

UNIT PACKAGE: 15



14266
(90189-06003)
Nylon

Screw Grommet
#14 (1/4") Or
M6.3-1.81 Screw Size
Head Diameter: 18mm
Stem Length: 21mm
Fits Into 8mm x 8mm Hole

UNIT PACKAGE: 15



14273
(90189-06005)
White Nylon

Screw Grommet
#14 (1/4") Or M6.3-1.81 Screw Size
Head Diameter: 18mm
Stem Length: 16mm
Fits Into 8mm x 8mm Hole
Lexus & Toyota

UNIT PACKAGE: 50



14267
(90189-06013)
Black Nylon

Screw Grommet
#14 (1/4") Or M6.3-1.81 Screw Size
Head Diameter: 20mm
Stem Length: 17mm
Fits Into 8mm x 8mm Hole
Lexus & Toyota

UNIT PACKAGE: 25



21237
(53867-47020)
Dark & Light Gray Nylon

Front Fender Retainer
With Sealer
Overall Height: 18mm
Fits Into 10mm x 16mm Hole
Prius
2004 - On

UNIT PACKAGE: 10



19534
(90467-10152)
Natural Nylon

Cowl Vent Grommet
Flange Diameter: 18mm
Stem Length: 16mm
Fits Into 9mm Hole
Use With Auveco 19535
Lexus ES300, Toyota Camry
& Tercel
1995-On

UNIT PACKAGE: 10



19535
(90467-07126)
Black Nylon

Cowl Vent Pin Retainer
Head Diameter: 16mm
Stem Length: 17mm
Use With Auveco 19534
Lexus ES300, Toyota Camry
& Tercel
1995 - On

UNIT PACKAGE: 10



20758
(53879-58010)
Black Nylon

Front Fender & Bumper
Cover Clip
Width: 25mm
Length: 34mm

Use With Auveco 20757
Lexus and Toyota 4 Runner,
Highlander, Sienna & Solara
2000 - On

UNIT PACKAGE: 5



20757
(47749-58010)
Black Nylon

Front Fender & Bumper
Cover Pin Retainer
Head Diameter: 15mm
Stem Length: 25mm

Use With Auveco 20758
Lexus and Toyota 4 Runner
Highlander, Sienna & Solara
2000 - On

UNIT PACKAGE: 10



19583
(90950-01911)
Black Nylon

Rocker Panel Retainer
Diameter: 25mm
Solara
1998-On

UNIT PACKAGE: 10



19014
(90467-10123)
Natural Nylon

Trim Panel Retainer
Head Size: 11mm x 12mm
Stem Length: 16mm
Fits Into 8mm Hole
Celica
1993-On

UNIT PACKAGE: 10



19686

(90467-05045-22)
Black Nylon

Weatherstrip Retainer
Head Diameter: 12mm
Stem Diameter: 5mm Sq.
Stem Length: 6mm
Solara
1998-On

UNIT PACKAGE: 25



20878

(90467-A0008)
Black Nylon

Bumper Cover Retainer
Head Diameter: 19mm
Stem Diameter: 7.5mm
Stem Length: 16mm
Toyota, Lexus & Scion
1995 - On

UNIT PACKAGE: 50



21626

(90467-06128)
Black Nylon

Weatherstrip Retaining Clip
Head Diameter: 12mm
Stem Diameter: 6.5mm
Stem Length: 11mm
Camry & RAV4
1992 - On

UNIT PACKAGE: 15



19312

(90467-05096-22)
Black Nylon

Luggage Compartment
Trim Panel Retainer
Head Diameter: 16mm
Stem Diameter: 5mm
Stem Length: 13mm
Tercel & Paseo
1994-On

UNIT PACKAGE: 25



21253

(90467-05164-B6)
Gray Nylon

Headliner Retainer
Head Diameter: 20mm
Stem Diameter: 6mm
Stem Length: 15mm
Yaris
2009 - On

UNIT PACKAGE: 25



21296

(90080-46010)
Black Nylon

Hood Seal
Retaining Clip
Head Diameter: 13mm
Stem Diameter: 7mm
Stem Length: 10mm
Camry
2010 - On

UNIT PACKAGE: 50



19643

(90467-06175)
Black Nylon

Luggage Compartment
Retainer
Head Diameter: 16mm
Stem Diameter: 6mm
Stem Length: 16mm
Solara
1998-On

UNIT PACKAGE: 15



21332

(90467-05164-E2)
Tan Nylon

Headliner Retainer
Head Diameter: 20mm
Stem Diameter: 6mm
Stem Length: 15mm
Corolla & Yaris
2009 - On

UNIT PACKAGE: 25



18297

(Toyota: 90467-08004,
90467-08011; GM:
94842841, 94849113)
Black Nylon

Hood Seal Retaining Clip
Head Diameter: 13mm
Stem Length: 11mm
Fits Into 6mm Hole
Lexus, Toyota, Geo Prizm & Nova
1985-On

UNIT PACKAGE: 50



20184

(90467-08186)
Black Nylon

Luggage Compartment
Trim Retainer
Head Diameter: 16mm
Stem Diameter: 8mm
Stem Length: 16mm
Camry
1999 - On

UNIT PACKAGE: 25



19121

(90467-08104)
Gray Nylon

Roof Headliner Retainer
Head Diameter: 20mm
Stem Diameter: 8mm
Stem Length: 20mm
MR2
1990-On

UNIT PACKAGE: 15



14737

(Toyota: 90467-07050,
90467-08008;
Nissan: 01553-00172)
Black Nylon

Retaining Clip
Head Diameter: 13mm
Stem Length: 15mm
Fits Into 5mm Hole
Panel Thickness: 3mm

UNIT PACKAGE: 25



21643
(90467-08101)
Black Nylon

Hood To Cowl Top Seal
Retaining Clip
Head Size: 7mm x 13mm
Stem Diameter: 7.5mm
Stem Length: 13mm
Toyota Camry, Sequoia, Solara
& Tundra and Lexus ES 300
2006 - 1997

UNIT PACKAGE: 25



21634
(90467-10186)
Black Nylon

Dash & Fender Apron
Seal Retainer
Head Diameter: 16.5mm
Stem Diameter: 9mm
Stem Length: 13mm
Toyota 4 Runner, FJ Cruiser,
Land Cruiser, RAV4, Sequoia,
Tundra and Lexus GX 460,
GX 470 & LX 470
1996 - On

UNIT PACKAGE: 25



16779
(Honda: 74842-659-0030; Toyota: 90467-12078)
Black Nylon

Retaining Clip
Head Dia: 18mm
Stem Length: 15mm
Panel Thickness: 6mm
Fits Into 8mm Hole

UNIT PACKAGE: 25



14736
(90467-06161-01)
Black Nylon

Retaining Clip
Head Diameter: 14mm
Stem Length: 10mm
Fits Into 5mm Hole
Panel Thickness: 3mm

UNIT PACKAGE: 25



19124
(90467-07096)
Black Nylon

Side Trim Panel
Retaining Clip
Head Diameter: 16mm
Stem Length: 10mm
Fits Into 6mm Hole
4WD Truck 1989-On

UNIT PACKAGE: 10



19842
(75867-30110)
Black Nylon

Rocker Panel Clip
Head Diameter: 18mm
Stem Length: 22mm
Fits Into 9mm Hole
Corolla
1997 - On

UNIT PACKAGE: 15



16781
(Honda: 90670-692-0030; Toyota: 90467-09065)
Black Nylon

Retaining Clip
Head Dia: 15mm
Stem Length: 20mm
Panel Thickness: 11mm
Fits Into 7mm Hole

UNIT PACKAGE: 25



16777
(Mazda: B001-68-302-00; Toyota: 90950-01248)
Black Nylon

Retaining Clip
Head Dia: 15mm
Stem Length: 15mm
Panel Thickness: 2mm
Fits Into 8mm Hole

UNIT PACKAGE: 25



21254
(90467-08136)
Black Nylon

Fender Seal
Retaining Clip
Head Diameter: 20mm
Stem Diameter: 8mm
Stem Length: 8mm
Snaps Into 7mm Hole
Yaris
2009 - On

UNIT PACKAGE: 25



19122
(90467-08122)
Natural Nylon

Headliner Retaining Clip
Head Diameter: 15mm
Stem Diameter: 8mm
Stem Length: 12mm
Tacoma & T100
1992-On

UNIT PACKAGE: 15



14347
(Toyota: 90467-10018; Nissan: 01553-00202)
Black Nylon

Retaining Clip
Head Diameter: 18mm
Stem Length: 12mm
Snaps Into 7mm Hole
Panel Thickness: 4mm
Toyota and Nissan

UNIT PACKAGE: 50



21211
(53326-08010)
Black Nylon

Hood Insulation
Retaining Clip
Head Diameter: 24mm
Stem Length: 12mm
Fits Into 7mm Hole
Sienna
2009 - On

UNIT PACKAGE: 25



19113
(90467-08124)
Black Nylon

Hood Insulation Retainer
Head Diameter: 25mm
Stem Diameter: 8mm
Stem Length: 12mm
Supra 1993-On
Lexus 1994-89

UNIT PACKAGE: 15



18842
(90467-09006)
Black Nylon

Hood Insulation Retainer
Head Diameter: 30mm
Stem Length: 17mm
Fits Into 7mm Hole
Avalon, Camry, Lexus
1988-On

UNIT PACKAGE: 15



21548
(67869-20030)
Black Nylon

Weatherstrip Retainer
Head Diameter: 10mm
Stem Diameter: 6mm
Stem Length: 10mm
Toyota Camry, Celica, Corolla,
Highlander, Matrix, MR-2,
Prius, RAV4, Scion, Solara & Supra
and Lexus IS 300 & SC 430
1990 - On

UNIT PACKAGE: 25



19729
(90467-09050)
Black Nylon

Hood Insulation Retainer
Head Diameter: 25mm
Stem Length: 10mm
Fits Into 7mm Hole
Lexus, Camry & Solara
1998-On

UNIT PACKAGE: 15



14738
(90467-09008)
Black Nylon

Retaining Clip
Head Diameter: 30mm
Stem Length: 17mm
Fits Into 7mm Hole
Panel Thickness: 6mm

UNIT PACKAGE: 25



21552
(90467-04034)
White Nylon

Weatherstrip Retainer
Top Head Size: 5mm x 15mm
Bottom Head Diameter: 9mm
Stem Diameter: 6.5mm
Stem Length: 4mm

Toyota Avalon, Corolla, Highlander,
Matrix, Prius, RAV4, Scion & Venza
and Lexus CT 200h, HS 250h, IS F,
IS 250, IS 350, LS 460, LS 600h,
RX 350, RX 400h & RX 450h
2003 - On

UNIT PACKAGE: 25



18878
(90467-08081)
Black Nylon

Hood Insulation Retainer
Head Diameter: 30mm
Stem Length: 16mm
Fits Into 6mm Hole
Celica
1993-89

UNIT PACKAGE: 15



19123
(90467-10107)
Black Nylon

Fender Apron Seal Clip
Head Diameter: 17mm
2WD & 4WD Truck
1988-On

UNIT PACKAGE: 10



21627
(67868-30030)
Black Nylon

Door & Roof Rail Retainer
Head Diameter: 9mm
Stem Diameter: 5.3mm
Stem Length: 8mm
Toyota Camry, Corolla, Corona
& Land Cruiser
1999 - 74
Lexus HS 250h, IS 250, IS 350,
RX 350 & 450h
2006 - On

UNIT PACKAGE: 25



19749
(67867-12150)
White Nylon

Weatherstrip Retainer
Head Size: 5mm x 15mm
Stem Length: 10mm
Fits Into 6mm Hole
Avalon
1995 - On

UNIT PACKAGE: 15



19112
(90467-09004)
Black Nylon

Hood Insulation Retainer
Head Diameter: 30mm
Stem Diameter: 8mm
Stem Length: 16mm
Tacoma
1995-On

UNIT PACKAGE: 15



18692

(Mazda: G031-58-762;
Toyota: 67868-89101,
67867-28030,
67867-89103; Ford:
E7GZ-6120586-B)
Natural Nylon

Weatherstrip Retainer
Head Size: 5mm x 15mm
Stem Length: 10mm
Fits Into 5mm Hole
4-Runner
1989-83
Mazda 1996-On
Ford

UNIT PACKAGE: 50



21551

(67869-12050)
Black Nylon

Weatherstrip Retainer
Top Head Diameter: 9mm
Bottom Head Diameter: 12mm
Stem Diameter: 7mm
Stem Length: 13mm
Corolla & Prius
2007 - 01

UNIT PACKAGE: 25



21226

(75867-02010)
Black Nylon

Rocker Moulding Retainer
Top Head Diameter: 13mm
Bottom Head Diameter: 18mm
Stem Diameter: 9mm
Stem Length: 10mm
Overall Length: 15.5mm
Corolla
2009 - On

UNIT PACKAGE: 25



20443

(67867-0C010)
Black Nylon

Weatherstrip Retainer
Head Size: 5mm x 15mm
Stem Length: 10mm
Fits Into 6mm Hole
Tundra
1999 - On

UNIT PACKAGE: 25



16778

(Mazda: 9927-40-822;
Toyota: 62581-14020)
Natural Nylon

Trim Panel Retainer
Top Head Dia: 14mm
Bottom Head Dia: 18.5mm
Stem Dia: 11.5mm
Stem Length: 14mm
Overall Length: 20mm

UNIT PACKAGE: 25



18861

(90467-10162)
White Nylon

Scuff Plate Retainer
Top Head Dia: 13mm
Bottom Head Dia: 18mm
Stem Dia: 8.5mm x 8.5mm
Stem Length: 12mm
Overall Length: 17mm
Celica
1993-On

UNIT PACKAGE: 15



19728

(90467-10146)
Black Nylon

Cowl Panel Retainer
Head Size: 8mm x 17mm
Stem Length: 14mm
Fits Into 7mm Hole
Sienna Van
1997 - On

UNIT PACKAGE: 25



20576

(GM: 88969790;
Toyota: 75867-21010)
Yellow Nylon

Fender Flare Retainer
Top Head Size: 10mm x 13mm
Bottom Head Size: 14mm x 18mm
Stem Diameter: 8.5mm x 8.5mm
Stem Length: 9mm
Overall Length: 13.5mm
Pontiac Vibe &
Toyota Echo
2002 - On

UNIT PACKAGE: 25



19719

(67921-32010)
White Nylon

Scuff Plate Retainer
Top Head Diameter: 13mm
Bottom Head Diameter: 18mm
Stem Dia: 10mm
Stem Length: 11mm
Overall Length: 17.5mm
Avalon, Camry & Corolla
1997 - On

UNIT PACKAGE: 15



19720

(90467-06138)
Black & White Nylon

Hood To Cowl Seal Retainer
Head Size: 8mm x 17mm
Stem Length: 16mm
Fits Into 7mm Hole
Avalon & Camry
1994 - On

UNIT PACKAGE: 10



21538

(75867-33030)

Charcoal Nylon

Rocker Moulding Retainer
 Top Head Diameter: 13mm
 Bottom Head Diameter: 18mm
 Stem Diameter: 9.5mm
 Stem Length: 13mm
 Overall Length: 18.5mm
 Avalon, Camry, Prius, Scion,
 Sienna, Solara & Venza
 2000 - On

UNIT PACKAGE: 25



20473

(67771-12070)

White Nylon

Door Panel &
 Rocker Moulding Retainer
 With Sealer
 Top Head Diameter: 13mm
 Bottom Head Diameter: 18mm
 Stem Diameter: 11mm
 Stem Length :14mm
 Overall Length: 20mm
 Lexus SC300/400
 Toyota Avalon & Corolla
 1992 - On

UNIT PACKAGE: 15



19109

(67771-30070)

Natural Nylon

Door Trim Panel
 & Garnish Retainer
 Top Head Dia: 13mm
 Middle Head Dia: 16mm
 Bottom Head Dia: 15mm
 Stem Diameter: 9.5mm
 Stem Length: 11mm
 Overall Length: 18mm
 Corolla Wagon, Tercel,
 T-100 & Tacoma 2WD
 1992-On

UNIT PACKAGE: 25



21012

(75867-AA010)

Black Nylon

Rocker Panel &
 Scuff Plate Retainer
 Top Head Diameter: 13mm
 Bottom Head Diameter: 18mm
 Stem Diameter: 9.5mm
 Stem Length: 14mm
 Overall Length: 18.5mm
 Lexus ES300 & ES330
 2002 - On
 Toyota Avalon, Camry,
 Scion & Solara
 2004 - On

UNIT PACKAGE: 15



21410

(90467-09212)

White Nylon

Cowl Trim Retainer
 Top Head Size: 13mm x 18mm
 Middle Head Diameter: 16mm
 Bottom Head Diameter: 18mm
 Stem Diameter: 10.7mm
 Stem Length: 12mm
 Overall Length: 16mm
 Camry
 2010 - On

UNIT PACKAGE: 25



20559

(GM: 88970345;

Toyota: 90467-10167)

Blue Nylon

Garnish Moulding Retainer
 Top Head Diameter: 13mm
 Middle Head Diameter: 16mm
 Bottom Head Diameter: 18mm
 Stem Diameter: 9mm x 9mm
 Stem Length: 11mm
 Overall Length: 18mm
 Pontiac Vibe, Lexus and Toyota
 2000 - On

UNIT PACKAGE: 25



18875

(67771-16170)

White Nylon

Door Trim
 Panel Retainer
 Top Head Dia: 13mm
 Bottom Head Dia: 18mm
 Stem Dia: 11mm
 Stem Length: 15mm
 Overall Length: 19.5mm
 Tercel
 1991-On

UNIT PACKAGE: 25



20558

(62217-13010)

White Nylon

Garnish Moulding Retainer
 Top Head Diameter: 13mm
 Middle Head Diameter: 16mm
 Bottom Head Diameter: 15mm
 Stem Diameter: 9mm x 9mm
 Stem Length: 11mm
 Overall Length: 17mm
 Lexus and Toyota Corolla,
 Matrix & 4 Runner
 2003 - On

UNIT PACKAGE: 25



19203

(67771-89104)

Natural Nylon

Quarter Board
 Inside Trim Panel Retainer
 Top Head Dia: 13mm
 Middle Head Dia: 16mm
 Bottom Head Dia: 18mm
 Stem Diameter: 11mm
 Stem Length: 11mm
 Overall Length: 18.5mm
 Truck 2WD
 1997-91

UNIT PACKAGE: 15



14728

(67771-22020)

Natural & Yellow Nylon

Door Panel Retainer
 Top Head Diameter: 12.5mm
 Middle Head Diameter: 16mm
 Bottom Head Diameter: 13mm
 Stem Diameter: 8.5mm
 Stem Length: 11mm
 Overall Length: 20mm

UNIT PACKAGE: 25



20575

(Toyota: 67771-12080;
 GM: 88970656)

Yellow & White Nylon

Door Panel & Rocker
 Moulding Retainer
 Top Head Dia: 13mm
 Middle Head Dia: 16mm
 Bottom Head Dia: 18mm
 Stem Diameter: 10mm
 Stem Length: 13mm
 Overall Length: 20mm

Toyota & Lexus
 1998 - On

Pontiac Vibe 2003 - On

UNIT PACKAGE: 15



20437

(90467-09206)

White Nylon

Trim Panel Retainer
 Top Head Dia: 13mm
 Middle Head Dia: 16mm
 Bottom Head Dia: 18mm
 Stem Dia: 8.5mm x 8.5mm
 Stem Length: 15mm
 Overall Length: 20mm

RAV 4 & Tundra
 2000 - On

UNIT PACKAGE: 15



18844

(67771-06010, 67771-32090)

White Nylon

Trim Panel Retainer
 Top Head Diameter: 13mm
 Middle Head Diameter: 16mm
 Bottom Head Diameter: 18mm
 Stem Diameter: 10mm
 Stem Length: 13mm
 Overall Length: 20mm
 Cowl Side & Garnish
 Center Pillar Retainer
 Camry
 1991-On

UNIT PACKAGE: 10



18876

(Toyota: 90467-10161;
 GM: 94858299)

White Nylon

Trim Board Retainer
 Top Head Dia: 13mm
 Middle Head Dia: 16mm
 Bottom Head Dia: 18mm
 Stem Dia: 9mm x 9mm
 Stem Length: 14mm
 Overall Length: 20mm

Toyota Sienna, Solara & Tercel
 1990-On

Geo Prizm & Pontiac Vibe
 1998-On

UNIT PACKAGE: 25



20633

(90467-10188)

Turquoise Nylon

Trim Panel Retainer
 Top Head Diameter: 13mm
 Middle Head Diameter: 16mm
 Bottom Head Diameter: 18mm
 Stem Diameter: 8.5mm x 9mm
 Stem Length: 14mm
 Overall Length: 20mm

Sienna
 2004 - On

UNIT PACKAGE: 25



18950

(90467-10168)

Black & White Nylon

Garnish Retainer
 Top Head Dia: 13mm
 Middle Head Dia: 16mm
 Bottom Head Dia: 18mm
 Stem Diameter: 10mm
 Stem Length: 13mm
 Overall Length: 20mm
 Avalon & Camry
 1991-On

UNIT PACKAGE: 5



19910

(90467-08179)

Yellow Nylon

Garnish Retainer
 Top Head Diameter: 13mm
 Middle Head Diameter: 16mm
 Bottom Head Diameter: 18mm
 Stem Diameter: 9mm x 9mm
 Stem Length: 14mm
 Overall Length: 20mm

Tundra
 1999 - On

UNIT PACKAGE: 25



21102

(90467-A0005)

White Nylon

Door Trim Panel Retainer
 With Sealer
 Top Head Diameter: 13mm
 Middle Head Diameter: 16mm
 Bottom Head Diameter: 18mm
 Stem Diameter: 8.5mm
 Stem Length: 14mm
 Overall Length: 20mm

Lexus ES 350, GX470, IS250, IS 350,
 IS F, LS 460 & LS 600HL
 and Toyota Camry, FJ Cruiser,
 Highlander, RAV4 & 4-Runner
 2001 - On

UNIT PACKAGE: 15



19257

(GM: 30006620;
Toyota: 67771-12050)
Maroon Nylon

Front & Rear Door
Trim Board Retainer
Top Head Diameter: 13mm
Middle Head Diameter: 16mm
Bottom Head Diameter: 18mm
Stem Diameter: 9.5mm
Stem Length: 14mm
Overall Length: 20.5mm
Chevrolet Geo, Metro & Tracker
1989 - On
Lexus and Celica,
Corolla & Previa
1990-On

UNIT PACKAGE: 15



14270

(67771-22010)
Blue & Natural Nylon

Door Panel Retainer
Top Head Diameter: 13mm
Middle Head Diameter: 15.5mm
Bottom Head Diameter: 18mm
Stem Diameter: 9.5mm
Stem Length: 14mm
Overall Length: 20.5mm

UNIT PACKAGE: 25



15707

(67771-03030)
Gray Nylon

Door Trim Retainer
Top Head Dia: 13mm
Middle Head Dia: 16mm
Bottom Head: 17.5mm
Stem Length: 14mm
Stem Diameter: 10mm
Overall Length: 21mm
Camry
1988 - On

UNIT PACKAGE: 50



14144

(67771-01010)
Black Nylon

Trim Panel Retainer
Top Head Diameter: 13mm
Middle Head Diameter: 15.5mm
Bottom Head Diameter: 18mm
Stem Diameter: 9.5mm
Stem Length: 14mm
Overall Length: 20.5mm

UNIT PACKAGE: 25



15709

(67771-02030)
Natural Nylon

Door Trim Retainer
Top Head Dia: 13mm
Middle Head Dia: 16mm
Bottom Head Dia: 17.5mm
Stem Diameter: 9.5mm
Stem Length: 13mm
Overall Length: 21mm
Corolla
1990 - On

UNIT PACKAGE: 50



19108

(67771-16080)
Natural Nylon

Door Trim Panel
& Back Panel
Upper Garnish Retainer
Top Head Dia: 13mm
Middle Head Dia: 16mm
Bottom Head Dia: 18mm
Stem Diameter: 9.5mm
Stem Length: 14mm
Overall Length: 21mm
Truck
1988-On

UNIT PACKAGE: 10



14269

(Toyota: 67771-01010,
67771-12010;
Isuzu: 8942264920;
Mazda: 9927-40-825)
White Nylon

Door Panel Retainer
Top Head Diameter: 13mm
Middle Head Diameter: 15.5mm
Bottom Head Diameter: 18mm
Stem Diameter: 9.5mm
Stem Length: 14mm
Overall Length: 20.5

UNIT PACKAGE: 25



19898

(67771-02030)
Yellow Nylon

Trim Panel Retainer
Top Head Dia.: 13mm
Middle Head Dia.: 16mm
Bottom Head Dia.: 18mm
Stem Diameter: 9.5mm
Stem Length: 13mm
Overall Length: 21mm
Corolla
1990 - On

UNIT PACKAGE: 50



18874

(67771-16120)
Gray Nylon

Front & Rear Door
Trim Panel Retainer
Top Head Dia: 13mm
Middle Head Dia: 16mm
Bottom Head Dia: 18mm
Stem Diameter: 9.5mm
Stem Length: 15mm
Overall Length: 21mm
Tercel
1994 - On

UNIT PACKAGE: 15



19016

(67771-12040)

Dark Gray Nylon

Door Trim Panel Retainer
 Top Head Dia: 13mm
 Middle Head Dia: 16mm
 Bottom Head Dia: 18mm
 Stem Diameter: 9.5mm
 Stem Length: 15mm
 Overall Length: 21mm
 Cressida
 1992 - 88

UNIT PACKAGE: 15



21103

(90467-05090-B1)

Black Nylon

Front Bumper Fascia
 Push-Type Retainer
 Head Diameter: 10mm
 Stem Length: 12mm
 Fits Into 5mm Hole
 Corolla, Matrix
 & Scion
 2008 - On

UNIT PACKAGE: 10



21249

(90467-07071-22)

Black Nylon

Bumper Cover
 Push-Type Retainer
 Head Diameter: 11mm
 Stem Length: 9mm
 (Not Including The Pin)
 Fits Into 7mm Hole
 Yaris
 2009 - On

UNIT PACKAGE: 25



19210

(67771-04040)

Natural Nylon

Front Door
 Trim Panel Retainer
 Top Head Dia: 13mm
 Middle Head Dia: 16mm
 Bottom Head Dia: 18mm
 Stem Diameter: 10mm
 Stem Length: 14mm
 Overall Length: 22mm
 Tacoma
 1995 - On

UNIT PACKAGE: 50



17383

(GM: 94847334, 96057847;

Toyota: 90467-07066;

Suzuki: 09409-07313)

Black Nylon

Radiator Grille
 & Trim Panel
 Push-Type Retainer
 Head Diameter: 11mm
 Stem Length: 14mm
 (Not Including The Pin)
 Fits Into 7mm Hole
 Toyota, Suzuki and
 Geo Tracker & Prizm
 1992 - 89

UNIT PACKAGE: 10



20196

(90467-06133-CO)

Black Nylon

Rocker Panel
 Push-Type Retainer
 Head Diameter: 14mm
 Stem Length: 8mm
 Fits Into 6mm Hole
 4-Runner
 1998 - On

UNIT PACKAGE: 15



19129

(Toyota: 67771-30090;

GM: 95008221)

Yellow Nylon

Door Trim Panel & Back Panel
 Lower Garnish Retainer
 Top Head Dia: 13mm
 Middle Head Dia: 16mm
 Bottom Head Dia: 18mm
 Stem Diameter: 9.5mm
 Stem Length: 17mm
 Overall Length: 23mm
 Land Cruiser & 2WD Truck
 1991 - On

UNIT PACKAGE: 15



21218

(90467-05063-C0)

Black Nylon

Front Bumper
 Push-Type Retainer
 Head Diameter: 11mm
 Stem Length: 8mm
 Fits Into 5mm Hole
 Corolla
 2009 - On

UNIT PACKAGE: 15



21104

(90467-07190-B2)

Black Nylon

Interior Trim
 Push-Type Retainer
 Head Diameter: 14mm
 Stem Length: 14mm
 Fits Into 7mm Hole
 Echo & Scion
 2004 - On

UNIT PACKAGE: 10



17162

(GM: 96057846;
Toyota: 90467-07041)
Black Nylon

Push-Type Retainer
Head Diameter: 15mm
Stem Length: 8mm
(Not Including The Pin)
Fits Into 6.3mm Hole
Geo Metro & Tracker
And Toyota
1989 - On

UNIT PACKAGE: 10



17206

(90467-09145)
Black Nylon

Bumper Cover
Push-Type Retainer
Head Diameter: 15mm
Stem Length: 12mm
Fits Into 9mm Hole
Camry
1992-On

UNIT PACKAGE: 15



21325

(90080-46294)
Black Nylon

Turn Signal Light &
General Purpose
Push-Type Retainer
Head Diameter: 16mm
Stem Length: 14mm
Fits Into 7mm Hole
Tundra
2003 - On

UNIT PACKAGE: 10



21120

(90467-07192)
Black Nylon

Cowl Vent
Push-Type Retainer
Head Diameter: 15mm
Stem Length: 9mm
(Not Including The Pin)
Fits Into 7mm Hole
RAV 4
2002 - On

UNIT PACKAGE: 15



21011

(90467-07188)
Black Nylon

Push-Type Retainer
Head Diameter: 15mm
Stem Length: 17mm
Fits Into 7mm Hole
Camry, Tundra
& 4-Runner
2002 - On

UNIT PACKAGE: 15



20335

(53879-60010)
Black Nylon

Fender Liner
Push-Type Retainer
Head Diameter: 18mm
Stem Length: 7mm
Fits Into 7mm Hole
Land Cruiser & RAV 4
1998 - On

UNIT PACKAGE: 15



14260

(Toyota: 90467-06017;
Mazda: 9926-50-625;
GM: 20426301)
Black Nylon

Push-Type Retainer
Head Diameter: 15mm
Stem Length: 12mm
Fits Into 7mm Hole

UNIT PACKAGE: 15



19552

(90467-07146)
Black Nylon

Cowl Panel & Luggage
Compartment Retainer
Head Dia.: 16mm
Stem Length: 9mm
Fits Into 7mm Hole
Avalon, Camry, Celica & Solara
1993 - On

UNIT PACKAGE: 15



20869

(GM: 88970767;
Toyota: 90467-10183)
Black Nylon

Front Fender Liner
Push-Type Retainer
Head Diameter: 18mm
Stem Length: 7.5mm
Fits Into 7mm Hole
Celica, Corolla,
Matrix & Solara, Lexus And
Pontiac Vibe
1999 - On

UNIT PACKAGE: 10



19013

(90467-07059-22)
Black Nylon

Rear Door Trim &
Luggage Compartment Door
Push-Type Retainer
Head Diameter: 15mm
Stem Length: 10mm
Fits Into 7mm Hole
Camry & Celica
1990-On

UNIT PACKAGE: 15



21624

(90467-10206)
Black Nylon

Cowl
Push-Type Retainer
Head Diameter: 16mm
Stem Length: 10mm
Fits Into 8mm Hole
Toyota Camry, Sequoia,
Tundra & Yaris and
Lexus ES 350, RX350 & RX 450h
2006 - On

UNIT PACKAGE: 15



19490

(90467-06150)
Black Nylon

Back Garnish Trim Panel
Push-Type Retainer
Head Diameter: 18mm
Stem Length: 8mm
Fits Into 6mm Hole
Tacoma
1995 - On

UNIT PACKAGE: 10



20349

(Toyota: 90467-08185;
Nissan: 01553-09611)
Black Nylon

Push-Type Retainer
Head Diameter: 18mm
Stem Length: 10mm
(Not Including The Pin)
Fits Into 8mm Hole
Lexus & Toyota
2002 - On
Nissan
1994 - On

UNIT PACKAGE: 15



21547

(90467-09185)
Black Nylon

Front Spoiler & Grille
Push-Type Retainer
Head Diameter: 18mm
Stem Length: 10mm
Fits Into 9mm Hole
Toyota Celica, Sequoia,
Sienna & 4 Runner and
Lexus HS 250h
1994 - On

UNIT PACKAGE: 25



21123

(75867-30120)
Black Nylon

Rocker Moulding
Push-Type Retainer
Head Diameter: 18mm
Stem Length: 12mm
(Not Including The Pin)
Fits Into 8mm Hole
Toyota Camry and Lexus GS350,
GS430, GS460 & LS460
2007 - On

UNIT PACKAGE: 15



16784

(Nissan: 80999-05N07;
Toyota: 90467-07043)
Black Nylon

Push-Type Retainer
Head Diameter: 18mm
Stem Length: 11mm
(Not Including The Pin)
Fits Into 7mm Hole
UNIT PACKAGE: 25



19416

(Toyota: 90467-09139)
Black Nylon

Bumper Cover &
Wheel Housing
Push-Type Retainer
Head Diameter: 18mm
Stem Length: 12mm
(Not Including The Pin)
Fits Into 9mm Hole
Honda, Mazda 626 &
Toyota Corolla
1992-On

UNIT PACKAGE: 15



21225

(53888-48010)
Black Nylon

Wheel Opening
Push-Type Retainer
Head Diameter: 18mm
Stem Length: 14mm
Fits Into 7mm Hole
Highlander
2001 - On

UNIT PACKAGE: 5



18873

(52161-16010,
52161-02020)
Black Nylon

Rear Bumper Cover
Push-Type Retainer
Head Diameter: 18mm
Stem Length: 28mm
Fits Into 9mm Hole
Tercel
1988-On

UNIT PACKAGE: 6



20931

(52161-20010)
Black Nylon

Bumper Cover & Grille
Push-Type Retainer
Head Diameter: 18mm
Stem Length: 31mm
Fits Into 9mm Hole
Toyota
2000 - On

UNIT PACKAGE: 15



19908

(90467-07121)
Black Nylon

Door Trim Panel
Push-Type Retainer
Head Diameter: 20mm
Stem Length: 8mm
(Not Including The Pin)
Fits Into 7mm Hole
RAV4
1997 - On

UNIT PACKAGE: 10



19907

(90467-07121-B2)
Gray Nylon

Door Trim Panel
Push-Type Retainer
Head Diameter: 20mm
Stem Length: 8mm
(Not Including The Pin)
Fits Into 7mm Hole
RAV4
1997 - On

UNIT PACKAGE: 10



20577

(GM: 88970494, 88973676
Toyota: 90467-07168)
Black Nylon

Rocker Panel & Garnish Moulding
Push-Type Retainer
Head Diameter: 20mm
Stem Length: 8mm
Fits Into 7mm Hole
Pontiac Vibe 2003 - On
Lexus & Toyota
2000 - On

UNIT PACKAGE: 15



18888
(90467-07166)
Black Nylon

Front Fender Liner
Push-Type Retainer
Head Diameter: 20mm
Stem Length: 8mm
(Not Including The Pin)
Fits Into 7mm Hole
Tercel
1994-On

UNIT PACKAGE: 15



19128
(90467-07044)
Black Nylon

Quarter Panel
Wheel Opening Moulding
Push-Type Retainer
Head Diameter: 20mm
Stem Length: 9mm
Fits Into 7mm Hole
T-100
1992-On

UNIT PACKAGE: 10



21294
(90467-07214)
Black Nylon

Radiator Splash Shield
Push-Type Retainer
Head Diameter: 20mm
Stem Length: 9mm
Fits Into 7mm Hole
Camry
2007 - On

UNIT PACKAGE: 25



21010
(90467-09166)
Black Nylon

Push-Type Retainer
Head Diameter: 20mm
Stem Length: 9mm
Fits Into 9mm Square Hole
Camry
2006 - On

UNIT PACKAGE: 15



20908
(Toyota: 90467-07164;
Suzuki: 09409-07332)
Black Nylon

Fender Splash Shield
Push-Type Retainer
Head Diameter: 20mm
Stem Length: 10mm
Fits Into 7mm Hole
Camry, Echo,
MR2 & Sienna
1997 - On
Suzuki 1999 - On

UNIT PACKAGE: 10



20955
(90467-07201)
Black Nylon

Engine Under Cover
Push-Type Retainer
Head Diameter: 20mm
Stem Length: 10mm
Fits Into 7mm Hole
Lexus ES300/330 and
Toyota Avalon, Camry & Solara
2002 - On

UNIT PACKAGE: 10



21596
(Toyota: 75867-06030)
Black Nylon

Rocker Panel
Push-Type Retainer
Head Diameter: 20mm
Stem Length: 16mm
Fits Into 8mm Hole
Toyota & Lexus
2007 - On

UNIT PACKAGE: 25



19140
(Acura: 90505-SL0-003;
GM: 94852368;
Mitsubishi:
MB888869; Toyota:
90467-08155)
Black Nylon

Push-Type Retainer
Head Dia: 20mm
Stem Length: 21mm
Fits Into 8mm Hole
Acura, Dodge Avenger, Eagle Talon,
Geo Prizm, Mitsubishi Eclipse
& Galant and Toyota
1993-On

UNIT PACKAGE: 5



19739
(90467-09127)
Black Nylon

Bumper Cover
Push-Type Retainer
Head Diameter: 20mm
Stem Length: 26mm
Fits Into 9mm Hole
Avalon, Camry,
Corolla & Solara
1998 - On

UNIT PACKAGE: 10



21366
(90467-09227)
Black Nylon

Bumper & Engine Under Cover
Push-Type Retainer
Head Diameter: 22mm
Stem Length: 15mm
Fits Into 9mm Hole
4 Runner, RAV4 & Scion XB
2006 - On

UNIT PACKAGE: 10



19219
(90467-09096)
Black Nylon
Front Bumper
Push-Type Retainer
Head Diameter: 15mm
Stem Length: 27mm
Fits Into 9mm Hole
Lexus LS400 1993-On
Celica & Supra 1989-On

UNIT PACKAGE: 10



14732
(53455-14020)
Nylon

Hood Prop
Rod Clip
Holds 8mm Dia. Rod
Snaps Into 14mm Hole
UNIT PACKAGE: 15



19529
(53455-33010,
53455-33011)
Natural Nylon

Hood Prop Rod Clip
Holds 9mm Rod
Fits Into 10mm Square Hole
Camry
1996 - On

UNIT PACKAGE: 15



20470
(69293-12040)
Yellow Nylon

Door Lock Rod Clip
Rod Size: 5mm
Left (Driver) Side
Lexus ES 300 2001 - 97
Toyota Camry, Celica, Corolla,
Echo, Highlander, MR2, RAV4,
Tundra and 4-Runner
1994 - On

UNIT PACKAGE: 10



16780
(Nissan: 99604-H1400;
Toyota: 58788-13010)

Hood Prop Rod Clip
Holds 11mm Dia. Rod
Fits Into 10mm x 12mm Hole
UNIT PACKAGE: 10



21336
(69293-30030)
Natural Nylon

Door Lock Rod Clip
Rod Size: 5mm
Fits Into 8mm Hole
Overall Height: 20mm
Toyota & Lexus
1993 - On

UNIT PACKAGE: 10



20534
(69293-12050)
Natural Nylon

Door Lock Rod Clip
Rod Size: 5mm
Fits Into 8.5mm Hole
Right (Passenger) Side
Lexus ES250, 300 & RX300
and Toyota Tacoma
1990 - On

UNIT PACKAGE: 10



17631
(90959-01136)
Nylon

Hood Prop Rod Clip
Holds 6mm & 7mm Rods
Toyota
UNIT PACKAGE: 25



20469
(69293-12030)
Natural Nylon

Door Lock Rod Clip
Rod Size: 5mm
Right (Passenger) Side
Lexus ES 300 2001 - 97
Toyota Camry, Celica, Corolla,
Echo, Highlander, MR2,
RAV4, Tundra and 4-Runner
1994 - On

UNIT PACKAGE: 10



20535
(69293-12060)
Yellow Nylon

Door Lock Rod Clip
Rod Size: 5mm
Fits Into 8.5mm Hole
Left (Driver) Side
Lexus ES250, 300 & RX300
And Toyota Tacoma
1990 - On

UNIT PACKAGE: 10



17611
(53452-90351)
Nylon

Hood Prop Rod Clip
Holds 6mm & 7mm Rods
Toyota
UNIT PACKAGE: 10

Not Actual Size



14284

(Toyota: 90463-10337;
Honda: 90669-671-0000;
90669-671-0030)

Nylon

Cable Strap
Length: 110mm (5-5/16")
Max. Bundle Diameter: 23mm
Fits Into 6mm Hole

UNIT PACKAGE: 15



16306

(90183-03001)

Front Bumper
Cushion Clip

Toyota
1982-On

UNIT PACKAGE: 25



14750

(Toyota: 53879-14010-A,
53879-14020,
53879-22030; GM: 94841226;
Mazda: LA01-56-135)

Black Nylon

Fender/Wheel
Housing
#10 Screw Size
20mm Wide
31mm Long

Panel Range: Up to 1mm
Center of Hole To Edge: 11mm
Toyota, Geo And Mazda

UNIT PACKAGE: 15



16671

(90468-04030)

Bumper Strip
Retainer

Toyota
1984-On

UNIT PACKAGE: 25



Not Actual Size

21553

(82711-12200)

Black Nylon

Cable Strap
Length: 170mm (6-3/4")
Width: 7mm (7/32")

Maximum Bundle Diameter:
40mm (1-9/16")

Camry, Celica, Corolla, Cressida,
Land Cruiser, MR-2, Paseo, Previa,
RAV4, Supra, T-100, Tercel
& 4-Runner
1998 - On

UNIT PACKAGE: 25



21611

(76879-44010)

Dacromet

Front and Rear Spoiler
Locking Fastener
16mm Wide

Corolla, Matrix, Prius
& Solara
2003 - On

UNIT PACKAGE: 15



21359

(53879-17020)

Black Nylon

Bumper & Fender Apron
"U" Nut

M4.8 (#10) Screw Size
Center Of Hole To Edge: 10mm
Panel Range: Up To 2mm
Toyota Celica and Lexus
2000 - On

UNIT PACKAGE: 10



Not Actual Size

20380

(Not Supplied
By O.E.M.)
Black Nylon

Cable Strap
Length: 200mm (8")
5mm (3/16") Wide
Max. Bundle Dia: 44mm (1-3/4")
Fits Into 6.3mm (1/4") Hole
Import Cars

UNIT PACKAGE: 25



21337

(65613-07010)

Black Nylon

Cowl Vent & Fender Apron
Nylon Flange Nut

Flange Diameter: 22mm
Stud Size: 6mm
Overall Height: 10mm
Venza
2009 - On

UNIT PACKAGE: 15



21616

(76647-42010)

Black Nylon

Fender & Mudguard
"U" Nut

M4.8 (#10) Screw Size
Panel Range: Up To 2mm
Center Of Hole To Edge: 7mm
RAV4
2001 - On

UNIT PACKAGE: 15



21613
(53879-20020)
Black Nylon

Front Fender Liner
Nylon "U" Nut
M5.5 (#12) Screw Size
Panel Range: Up To 2mm
Center Of Hole To Edge: 11mm
Camry & Sienna
1996 - On

UNIT PACKAGE: 15



21614
(90467-05128)
White Nylon

Rear Bumper & Bumper Stay
Nylon "U" Nut
M6 (#14) Screw Size
Panel Range: Up To 2mm
Center Of Hole To Edge: 12mm
RAV4 & Yaris
1996 - On

UNIT PACKAGE: 15



14276
(53879-22010)
Black Nylon

Nylon "U" Nut
Fender/Wheel
Housing Applications
#14(1/4") Screw Size
20mm Wide
29mm Long
Panel Range: Up To 1mm
Center Of Hole To Edge: 15mm

UNIT PACKAGE: 15



20956
(90467-05114)
Black Nylon

Bumper & Fender Apron
Nylon "U" Nut
Screw Size: M5.5 (#12)
Width: 20mm, Length: 36mm
Panel Range: Up To 1mm
Center Of Hole To Edge: 14mm
Lexus & Toyota
2000 - On

UNIT PACKAGE: 10



21615
(90467-A0018,
90467-05081)
Maroon Nylon

Left & Right Front Bumper
& Bumper Stay
Nylon "U" Nut
M6 (#14) Screw Size
Panel Range: Up To 2mm
Center Of Hole To Edge: 12mm
Toyota Avalon, Camry & Solara
and Lexus
2000 - On

UNIT PACKAGE: 15



13225
Plated

"U" Type Nut
4.2mm (#8) Screw Size
11mm Wide
16.5mm Long
Panel Range: .5mm-2.5mm
Center of Hole To Edge: 8mm

UNIT PACKAGE: 50

HELPFUL HINTS FOR USING THE AUVECO CATALOG

1. **The color-coded pages** signify various sections which are as follows:
BLUE - Metric Items
BEIGE - Electrical Accessories
GREEN - Assortments, Cabinets, Bins & Racks
GRAY - Key Blanks & Accessories
PINK - Import Car Body Hardware
2. Most pictures and illustrations are actual size.
3. We have **Specification Charts** for:
Body Bolts (pages 20 & 49-50)
Special Tapping Screws (pages 23-26 & 54-57)
License Plate Screws (pages 33-34)
"Xmas Tree" Retainers (pages 404-413)
Push-Type Retainers (pages 450-460)
4. We have **three different types of indexes** in the front of the catalog to assist you.
PICTORIAL QUICK INDEX ALPHABETICAL INDEX NUMERICAL INDEX
5. There are two **O.E.M Part Cross References** at the back of the catalog.

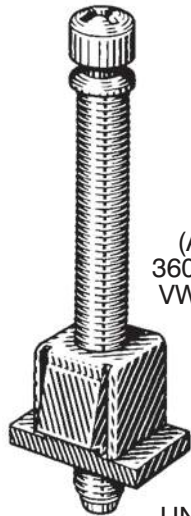

15666

(AMC: 36000148,
36001966, 56001419;
VW: 176-941-1117A)

1/4"-28 x 2-1/4"
Headlight Adjusting
Screw and
Nut Assembly
AMC & VW

UNIT PACKAGE: 10



12635

(801-853-577)
Nylon

Moulding Clip
VW

UNIT PACKAGE: 25



19136

(1HO-853-733B)
Nylon

Windshield Reveal
Moulding Clip
VW Golf & Jetta
1999-93

UNIT PACKAGE: 15



10322

(131-853-585C)
Nylon

Body Side Moulding Clip
VW

UNIT PACKAGE: 50



13189

(803-853-139A)
Nylon

Moulding Clip
Audi

UNIT PACKAGE: 50



13174

(803-853-139C)
Red Nylon

Moulding Clip
VW

UNIT PACKAGE: 25



13229

(113-853-585C)
Nylon

Moulding Clip
w/ Sealer
VW

UNIT PACKAGE: 50



21416

(191-853-733-A)
White Nylon

Moulding Clip
Width: 8mm
Length: 31mm
Passat
1997 - 90

UNIT PACKAGE: 25



21493

(4A0-853-825-A)
White Nylon

Front & Rear Door
Moulding Clip
Width: 22mm
Length: 35mm
Audi
1998 - 92

UNIT PACKAGE: 25



21390

(191-853-577-A)
White Nylon

Door Moulding Clip
Top Head Size: 11.6mm x 15mm
Bottom Head Diameter: 11mm
Stem Diameter: 6mm
Stem Length: 14mm
VW & Audi
1985 - On

UNIT PACKAGE: 25



21508

(191-853-577)
White Nylon

Door Trim & Scuff Plate
Moulding Clip
Head Size: 12mm x 15mm
Stem Diameter: 10mm
Stem Length: 19mm
Audi A1 & A2 and VW Golf & Jetta

UNIT PACKAGE: 25



21449
(3B0-853-575)
White Nylon
With Blue Rubber Grommet

Moulding Clip
Width: 17.5mm
Length: 21mm
Stem Length: 12mm
Passat
2005 – 1998

UNIT PACKAGE: 25



21481
(Audi: 4A0-853-825-C)
White Nylon

Rear Door
Moulding Clip
Width: 26mm
Length: 34.5mm
Stem Length: 6mm
Audi 100, A6, S4, S6 & Quattro
1998 – 92

UNIT PACKAGE: 25



21394
(1H0-853-585)
White Nylon
With Blue Rubber Grommet

Door Moulding Clip
Width: 34mm
Length: 38.5mm
Stem Length: 10mm
Audi & VW Cabrio, Golf
& Jetta
2002 – 1993

UNIT PACKAGE: 15



21512
(7L0-839-069)
White Nylon

Rocker Panel
Moulding Clip
Width: 10mm
Length: 28.5mm
Stem Length: 11mm
Fits Into 10mm Hole
Touareg
2010 – 05

UNIT PACKAGE: 25



21448
(3A0-853-575-A)
White Nylon
With Blue Rubber Grommet

Moulding Clip
Width: 16mm
Length: 17mm
Stem Length: 13mm
Passat
1997 - 95

UNIT PACKAGE: 25



21395
(1H0-853-585-B)
White Nylon
With Blue Rubber Grommet

Door Moulding Clip
Width: 34mm
Length: 38.5mm
Stem Length: 18mm
Audi & VW Cabrio
2002 – 1999

UNIT PACKAGE: 15



21491
(443-853-909-A)
Natural Nylon

Front Door, Fender &
Quarter Panel
Moulding Clip
Width: 20mm
Length: 41.5mm
Audi
1998 – 88

UNIT PACKAGE: 25



21447
(3B0-853-576)
White Nylon
With Blue Rubber
Grommet

Moulding Clip
Width: 24.5mm
Length: 27mm
Stem Length: 12mm
Passat
2005 – 1998

UNIT PACKAGE: 15



21492
(4A0-853-825)
White Nylon

Front & Rear Door, Fender &
Quarter Panel
Moulding Clip
Width: 22mm
Length: 35mm
Overall Height: 16mm
Audi
1998 – 92

UNIT PACKAGE: 25



21396

(1H0-853-858-A)

White Nylon

With Blue Rubber Grommet

Quarter Panel

Moulding Clip

Width: 23mm

Length: 40mm

Stem Length: 11mm

Audi & VW Cabrio, Golf & Jetta

2002 – 1993

UNIT PACKAGE: 15



13176

(113-853-585B)

Metal

Moulding Clip

UNIT PACKAGE: 25



8843

Nylon

Moulding Fastener
Fits 1/2" -5/8" Mouldings

UNIT PACKAGE: 50



21498

(191-941-142)

White Nylon

Headlight Adjusting Nut
Head Size: 14mm x 18.5mm
Overall Length: 15mm
Fits Into 10mm Hole
Audi 100 and VW Golf
1994 – 86

UNIT PACKAGE: 25



14014

(VW: 175-853-674;

GM: 20475950)

Black Nylon

Air Vent Nut
Use With 14013 Screw

UNIT PACKAGE: 50



12735

(GM: 1370853;

Chry: 6029501;

VW: 179-813-883)

Nylon

Headlight Bezel Nut
#6 Screw Size

GM & VW

1982-On

UNIT PACKAGE: 50



14030

(GM: 3997391;

VW: 179-813-881)

Black Nylon

Tail Light Nut

#8 Screw Size

GM Astro & Safari

1985-On

Volkswagen

UNIT PACKAGE: 25



21510

(867-809-966, 811-807-557-C)

Black Nylon

Screw Grommet

M4.8 (#10) Screw Size

Head Diameter: 12mm

Stem Length: 12.5mm

VW & Audi

UNIT PACKAGE: 25



21480

(VW: 165-827-592)

Natural Nylon

Screw Grommet

M4.2 (#8) Screw Size

Head Diameter: 11mm

Stem Length: 13mm

VW Cabrio, EuroVan, Golf
& Jetta

2003 – 1992

UNIT PACKAGE: 25



20924

(N908-338-01)

Black Nylon

Fender Apron Screw Grommet

M4.2 (#8) Screw Size

Head Dia: 15mm

Stem Length: 12mm

Cabrio, Golf, Jetta &

Phaeton

1999 - On

UNIT PACKAGE: 15



21478

(3A0-853-575)

White & Orange

Nylon With Blue

Rubber Boot

Door, Fender & Quarter Panel

Moulding Clip

Width: 35mm

Length: 38mm

Stem Length: 14mm

Volkswagen

1997 – 90

UNIT PACKAGE: 15



13173

(VW: N14389.3;

Volvo: 3104-426)

Metal

Door Panel Clip

Use With 13206

UNIT PACKAGE: 50



20925

(N908-214-01)
Black Nylon

Bumper & Fender Apron
Screw Grommet
M4.2 (#8) Screw Size
Head Dia: 15mm
Stem Length: 20mm
Audi A4/S4 and A6/S6
1996 - On

VW Cabrio, Golf, Jetta & Phaeton
1999 - On

UNIT PACKAGE: 15



21399

(811-807-577-C)
Black Nylon

Screw Grommet
M4.8 (#10) Screw Size
Head Diameter: 7mm x 12.5mm
Stem Length: 11mm
Audi Quattro, A4, A6, A8, RS6,
S4, S6, TT & 90 and Volkswagen
Golf, Jetta & Passat
2010 - 1990

UNIT PACKAGE: 25



20933

(357-827-998)
Black Nylon

Front & Rear Door Panel
Screw Grommet
M4.8 (#10) Screw Size
Head Diameter: 16mm
Stem Length: 20mm
Cabrio, Golf,
Jetta & Passat
1993 - On

UNIT PACKAGE: 15



20260

(1J0-853-120)
Maroon Nylon

Scuff Plate
Screw Grommet
Head Size: 14mm x 17mm Oval
Stem Length: 10mm
M4.2 (#8) Screw Size
Golf & Jetta
1999 - On

UNIT PACKAGE: 15



13227

(113-853-615A)
Nylon

Barrel Nut
For 3mm Stud
Fits Into 4mm Hole

UNIT PACKAGE: 50



20250

(357-853-586-D)
Black Nylon

Moulding Insert
Head Diameter: 13mm
Stem Length: 6mm
Fits Into 9mm Hole
Eurovan, Golf, Jetta
& Passat
1989 - On

UNIT PACKAGE: 25



13206

(113-857-219A)
Black Vinyl

Door Panel & Trunk Liner Plug
Use With 13173

VW Beetle & Audi

UNIT PACKAGE: 50



21397

(1H0-853-586)
Blue Rubber

Moulding Clip Grommet
I.D.: 7mm
Flange O.D.: 13mm
Overall Length: 12mm

Use With Auveco Moulding Clips

21394, 21395 & 21396
Audi and VW Cabrio, Golf,
Jetta, Passat & Touareg
2007 - 1990

UNIT PACKAGE: 50



21497

(1H0-837-719)
Black Nylon

Weatherstrip Retainer
With Clear Grommet
Head Size: 6mm x 15mm
Stem Diameter: 7.5mm
Stem Length: 17mm
Audi A3 and VW Golf, Sharan,
Transporter & Corsa

UNIT PACKAGE: 25



21392

(1H0-819-055-B01C)
Black Nylon

Instrument Panel, Cowl Vent,
Defroster Grille & Ducts
Retainer

Head Diameter: 23mm
Stem Diameter: 6.5mm
Stem Length: 16mm
Phillips Drive

Audi and Volkswagen Cabrio,
Golf & Jetta
2002 - 1993

UNIT PACKAGE: 25



21515

(4A0-805-121-A)
Black Nylon

Front Fender, Bumper &
Engine Cover
Retainer
Slotted Drive
Head Diameter: 25mm
Stem Length: 22mm
Passat & Audi
1992 - On

UNIT PACKAGE: 25



21509

(357-853-575)
White Nylon

Retainer With Gray Grommet
Top Head Diameter: 12mm
Bottom Head Diameter: 18mm
Stem Diameter: 10mm
Stem Length: 16mm
Golf, Jetta, Passat & Scirocco

UNIT PACKAGE: 25



21495

(7L5-853-994)
Blue Nylon

Trim Panel Retainer
Top Head Diameter: 13mm
Bottom Head Diameter: 18mm
Stem Diameter: 9mm
Stem Length: 14mm
VW, Audi & Renault

UNIT PACKAGE: 25



21494

(171-807-249-A)
Natural Nylon

Trim Panel Retainer
Top Head Diameter: 12mm
Bottom Head Diameter: 18mm
Stem Diameter: 9.5mm
Stem Length: 12mm
VW Golf & Audi
1978 - On

UNIT PACKAGE: 25



21496

(357-853-585-A)
White Nylon

Trim Panel Retainer
With Black Nylon Grommet
Top Head Diameter: 12mm
Bottom Head Diameter: 18mm
Stem Diameter: 10mm
Stem Length: 12mm
Golf & Passat and Audi B3

UNIT PACKAGE: 15



21516

(357-853-585)
White Nylon

Retainer
With Black Nylon Grommet
Top Head Diameter: 12mm
Bottom Head Diameter: 18mm
Stem Diameter: 10mm
Stem Length: 20mm
VW Golf A2 & A3 and Audi

UNIT PACKAGE: 25



20252

(823-867-299)
Black Nylon

Trim Panel Retainer
Top Head Dia: 14mm
Bottom Head Dia: 18mm
Stem Dia: 9mm
Stem Length: 14mm
Corrado, Eurovan, Jetta,
Rabbit & Vanagon
1979 - On

UNIT PACKAGE: 25



21252

(Audi: 8E0-867-276)
White Nylon

Trim Panel Retainer
Top Head Diameter: 13mm
Bottom Head Diameter: 15mm
Stem Diameter: 9mm
Stem Length: 11mm
Audi
2002 - On

UNIT PACKAGE: 25



13475

(Renault:
8934-201-681;
VW: 175-867-299)
White Nylon

Trim Panel Retainer
Head Dia: 19mm
Stem Length: 18mm
Stem Dia: 9mm
AMC-Renault 1984-On
VW 1982-On

UNIT PACKAGE: 50



20341

(3B0-868-243)
Black Nylon

Door Trim Panel Retainer
Head Diameter: 22mm
Stem Length: 10mm
Fits Into 10mm Hole
Beetle, Golf, Jetta & Passat
1998 - On

UNIT PACKAGE: 25



21450

(703-867-299)
Black Nylon

Side Panel & Interior
Trim Retainer
Top Head Diameter: 13.5mm
Bottom Head Diameter: 18mm
Stem Diameter: 9mm
Stem Length: 14mm
VW

2003 - 1993

UNIT PACKAGE: 25



13179

(481-867-197)
Black Nylon

Trim Panel Retainer
VW

UNIT PACKAGE: 50



21398
(6K0-868-243-C)
Black Nylon

Trim Panel Retainer
Top Head Diameter: 22mm
Bottom Head Diameter: 18mm
Stem Length: 12mm
Fits Into 8mm Hole
Audi and Volkswagen Touareg
2010 – 2004

UNIT PACKAGE: 25



21415
(1H0-868-243-B)
Tan and White Nylon

Adjustable
Door Trim Panel Retainer
Head Diameter: 28.5mm
Stem Diameter: 9.5mm
Stem Length: 11mm
Overall Length: 31mm
Golf
2002 – 1993

UNIT PACKAGE: 25



19195
(161-867-299-01C)
Black Nylon

Push-Type Retainer
Head Diameter: 16mm
Stem Length: 12mm
Fits Into 8mm Hole
VW Golf & Jetta
1997-93

UNIT PACKAGE: 25



21144
(8E0-868-243)
Black Nylon

Interior Trim Panel Retainer
With Sealer
Top Head Diameter: 21.5mm
Bottom Head Diameter: 27mm
Stem Diameter: 11mm
Stem Length: 19mm
Audi A4 & S4, Avant, Cabriolet,
Quattro & Sedan Wagon,
2005 – On

UNIT PACKAGE: 25



21145
(1H5-863-849-A-01C)
Black Nylon

Hood Insulation Retainer
Head Size: 20mm x 25mm
Stem Length: 13mm
Fits Into 12mm Hole
Audi A4, A6, Cabriolet, Quattro,
S4 & S6 and Volkswagen Beetle,
Golf, Jetta, Passat, Rabbit & Touareg
1998 – On

UNIT PACKAGE: 15



21451
(333-867-633-4FB)
Black Nylon

Front Lights & Windshield Washer
Push-Type Retainer
Head Diameter: 14mm
Stem Length: 10mm
Fits Into 8.5mm Hole
VW
1998 – 95

UNIT PACKAGE: 25



21393
(1H0-868-243)
Green & Black Nylon

Trim Retainer
Large Head Diameter: 28mm
Small Head Diameter: 19mm
Overall Length: 31mm
Audi and Volkswagen Cabrio,
Golf & Jetta
1999 – 1993

UNIT PACKAGE: 25



21391
(N038-550-1)
Dark Gray Nylon

Bumper, Exterior Trim,
Fender, Quarter Panel &
Wheel Opening
Push-Type Retainer
Head Diameter: 12mm
Stem Length: 11mm
Fits Into 8mm Hole
Audi and
Volkswagen EuroVan, Golf,
Jetta & Passat
2003 – 1985

UNIT PACKAGE: 25



21479
(701-867-299)
Gray Nylon

Front Bumper & Interior Trim
Push-Type Retainer
3mm Allen Head Drive
Head Diameter: 18.5mm
Stem Length: 11mm
Fits Into 9mm Hole
VW Jetta & Passat
1999 – On

UNIT PACKAGE: 25



21251
(6Q0-868-243)
Black & White Nylon

Trim Panel
Push-Type Retainer
With Sealer
Head Diameter: 22.5mm
Stem Length: 7mm
(Not Including The Pin)
Fits Into 8mm Hole
Golf, Jetta, Passat, Phaeton,
Rabbit & Tiguan
2004 – On

UNIT PACKAGE: 15



21483
(1H0-823-397)
Natural Nylon

Hood Prop Rod Clip
Rod Size: 8mm
Stem Length: 10mm
Fits Into 7mm Square Hole
VW
1999 – 93

UNIT PACKAGE: 25



21513
(N90-335-006)
Dacromet

Splash Shield & Wheel Well
Push-On Retainer
Stud Size: 5mm
O.D.: 30mm
VW & Audi

UNIT PACKAGE: 25



21452
(1H0-819-055-C01C)
Black Nylon

Push-Type Retainer
Top Head Diameter: 23mm
Bottom Head Diameter: 16mm
Stem Length: 15mm
Fits Into 8mm x 8mm Square Hole
VW
2002 – 1993

UNIT PACKAGE: 25



21514
(6N0-823-397-AC)
Black Nylon

Hood Prop Rod Clip
Rod Size: 8mm
Head Diameter: 15mm
Fits Into 7mm Square Hole
VW & Audi

UNIT PACKAGE: 25



21485
(N90-796-501,
N90-796-502)
Dacromet

Radiator Support & Splash Shield
Push-On Retainer
Stud Size: 5mm
O.D.: 30mm
VW
2006 – 1999

UNIT PACKAGE: 25



21482
(1H0-867-199-A)
Black Nylon

Push-Type Retainer
Head Diameter: 24mm
Stem Length: 13mm
Fits Into 9mm Square Hole
Passat
1999 – 90

UNIT PACKAGE: 25



Not Actual Size

21305
(Not Available From O.E.M.)
Natural Nylon

Push-Mount Cable Strap
Overall Length: 156mm (6-1/8")
Strap Width: 5mm (3/16")
Snaps Into 6.3mm (1/4") Hole
Maximum Bundle Diameter:
40mm (1-9/16")
European Makes & Universal

UNIT PACKAGE: 25



13217
(N15.422.2)
Plated

"U" Nut
4.2mm (#8) Screw Size
Panel Range: .7mm -1.6mm
Center Of Hole To Edge: 7mm

UNIT PACKAGE: 25



13216

Zinc

"U" Nut
4.8mm Screw Size
Panel Range: .9mm -2mm
Center Of Hole To Edge: 8mm

UNIT PACKAGE: 25



21456

(171-201-969)
Black Nylon

Moulding Nylon Flange Nut
Stud Size: 5mm
Hex: 10mm
Flange Diameter: 18.5mm
Overall Height: 10.5mm
Audi A8, S8 & 90
2003 - 1993

UNIT PACKAGE: 25



12595

(GM: 11503752, 11505329;
VW: N90100001)
Phosphate

Free Spinning Washer Nut
M6-1.0
16mm Washer O.D.
10mm Hex

UNIT PACKAGE: 25

16268

Same As 12595 Except For Packing

UNIT PACKAGE: 50



14013

(GM: 20475949;
VW: 175-853-673)
Black Nylon

Air Vent Screw
Use With 14014

UNIT PACKAGE: 50



11404

(N14-4003)
Plain Steel

Manifold Stud
M8-1.25 x 35mm

UNIT PACKAGE: 25



13031

(111-837-581J)
Black Nylon

Window Crank Handle
VW Beetle

UNIT PACKAGE: 1



14194

(321-837-581-016)

Window Crank Handle
VW, Scirocco & Dasher
1974-On

UNIT PACKAGE: 1

You Can E-Mail
Your New Item
Suggestions To
mail@auveco.com

Volvo



12637

(591-740)
Nylon

Body Side
Moulding Clip

UNIT PACKAGE: 50



13195

(1201-930)
Black Nylon

Moulding Clip

UNIT PACKAGE: 10



20405

(9151649-2)
White Nylon

Rocker Panel Moulding Clip
Stem Length: 14mm,
Fits Into 8mm Hole
850, C70, S70 & V70
1993 - On

UNIT PACKAGE: 10



13173

(VW: N14389.3;
Volvo: 3104-426)

Metal
Panel Clip

UNIT PACKAGE: 50



14211

(1-255-551)
Black Nylon

Windshield Clip

UNIT PACKAGE: 25



14212

(1-246-926)
Gray Nylon

Windshield Clip

UNIT PACKAGE: 25



14210

(1-255-553)
White Nylon

Windshield Clip

UNIT PACKAGE: 15



14209

(1-246-993)
Green Nylon

Windshield Clip

UNIT PACKAGE: 15



13191

(680-097)
Black Nylon

Moulding Retainer

UNIT PACKAGE: 50



13230

(Mercedes 000-990-03-92;
Volvo 947-098)
Black Nylon

Push-Type Retainer

Head Dia. 10mm

Stem Length: 7mm

Fits Into 5mm Hole

UNIT PACKAGE: 50



19904

(9133417-7)
Black Nylon

Rocker Panel

Push-Type Retainer

Head Diameter: 16mm

Stem Length: 14mm

Fits Into 9mm Hole

850 Series

1994 - On

UNIT PACKAGE: 15



19248

(1268176-3)
Black Nylon

Bumper Cover

Push-Type Retainer

Head Diameter: 16mm

Stem Length: 14mm

Fits Into 6mm Hole

740 & 760

1993-On

UNIT PACKAGE: 15



20407

(9133073-8)
Black Nylon

Hood Insulation &

Radiator Seal Push-Type Retainer

Head Size: 8mm x 25mm

Stem Length: 10mm

Fits Into 5mm Hole

850, 940, 960, S80, S90 & V90

1991 - On

UNIT PACKAGE: 25



19249

(3512624-2)
Black Nylon

Rocker Panel

Push-Type Retainer

Head Diameter: 16mm

Stem Length: 12mm

Fits Into 8mm Hole

1993-On

UNIT PACKAGE: 25



13220

(Mercedes
000-994-09-45;
Volvo 946-418;
Opel 20-72-175)
Plated

"U" Type Nut

6.3mm Screw Size

Panel Range: .7mm-1.5mm

Center of Hole To Edge: 13mm

UNIT PACKAGE: 50

UNIVERSAL EUROPEAN IMPORT FASTENERS



16132

Black Nylon

Trim Panel Retainer

Head Dia: 19mm

Stem Length: 20mm

Fits Into 8mm Hole

UNIT PACKAGE: 25



16134

Zinc & Yellow

Thread Cutting Nut

With Sealer

For 3mm Stud

13.5mm O.D.

8mm Hex

UNIT PACKAGE: 25

UNIVERSAL TYPE MOULDING FASTENERS

(ILLUSTRATIONS ACTUAL SIZE)



9965
(GM: 1244839,
3944866)

Moulding Fastener

UNIT PACKAGE: 25

12971

Same as 9965 Except Packing

UNIT PACKAGE: 10



2744
(Chry: 1624705,
6010093)

Moulding Fastener
#10-24 x 3/4" Bolt
Plate Length: 3/4"
Plate Width: 5/16"

UNIT PACKAGE: 50

12959

Same as 2744 Except for Packing

UNIT PACKAGE: 15



19626
(Ford: 358560;
Chry: 1560058;
6010029;
GM: 568792;
574355;
1165051)

Moulding Fastener
#10-24 x 3/4" Bolt
Plate Length: 1"
Plate Width: 1/2"

Replaces Auveco 2514

UNIT PACKAGE: 25

19627

Same as 19626 Except for Packing

UNIT PACKAGE: 15



2943
(4759145,
4761842,
4779348)

Front and Rear Fender and Door
Peak Moulding Fastener
GM

UNIT PACKAGE: 50

12966

Same As 2943 except packing

UNIT PACKAGE: 15



2818
(GM: 4689929,
4778814)

Moulding Fastener
#10-24 x 3/4" Bolt
Plate Length: 3/4"
Plate Width: 5/16"

UNIT PACKAGE: 50

12962

Same as 2818 Except for Packing

UNIT PACKAGE: 15



20175
(463277,
4730773)

Moulding Fastener
#10-24 x 3/4"
Plate Length: 1-5/8"
Plate Width: 11/16"
Replaces Auveco 2821

UNIT PACKAGE: 25

Sec. 23

UNIVERSAL TYPE MOULDING FASTENERS

(ILLUSTRATIONS ACTUAL SIZE)



2789

(GM: 575411,
4723818)

Moulding Fastener
#10-24 x 5/8" Bolt
Plate Length: 1-5/8"
Plate Width: 9/16"

UNIT PACKAGE: 50

12961

Same as 2789 Except for Packing

UNIT PACKAGE: 15



2752

(GM: 3744999;
Chry: 1758099;
6000720;
6010046)

Moulding Fastener
#10-24 x 3/4" Bolt
Plate Length: 1-25/32"
Plate Width: 9/16"

UNIT PACKAGE: 50

12960

Same As 2752 Except Packaging

UNIT PACKAGE: 15

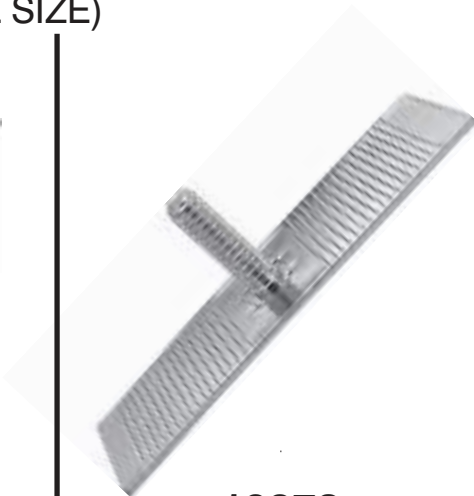

19378

Zinc

Universal Moulding Fastener
#10-24 x 3/4" Bolt
2-1/2" x 3/4" Plate
Break Off Plate At 1/16" Perforations
To Fit Moulding
Replaces Auveco 2356
Use With Auveco Hex Nut 730

UNIT PACKAGE: 25



2619

(Chry: 6000705,
6013029;
GM: 3722635)

Moulding Fastener
#10-24 x 3/4" Bolt
Plate Length: 1-11/32"
Plate Width: 1/2"

UNIT PACKAGE: 50

12958

Same as Above Except for Packing

UNIT PACKAGE: 15



19807

(GM: 4676189)

Moulding Fastener
#10-24 x 3/4" Bolt
Plate Length: 2-17/32"
Plate Width: 11/16"

Replaces Auveco 2820

UNIT PACKAGE: 15



8581

Nylon

Moulding Fastener
Plate Length: 3"
Plate Width: 3/4"
Break Off Plate
At 5/32" Perforations
To Fit Moulding

UNIT PACKAGE: 10

UNIVERSAL TYPE MOULDING FASTENERS

Sec. 23

(ILLUSTRATIONS ACTUAL SIZE)



5889

Universal
Moulding Fastener
For 5/16"-1/2" Moulding
Fits Into 3/8" Hole

UNIT PACKAGE: 50



8448

(GM: 4879481)
Nylon

Front & Rear Door
Moulding Fastener
For 3/4" To 1" Moulding

UNIT PACKAGE: 50



8399

(GM: 4883164)
Nylon

Rear Fender Lower
Moulding Fastener
For 7/8" To 1-1/4" Mouldings

UNIT PACKAGE: 25



8843

Nylon

Moulding Fastener
For 1/2"-5/8" Mouldings

UNIT PACKAGE: 50



8398

(GM: 4853108)
Nylon

Front & Rear Door and
Quarter Panel Moulding Fastener
For 3/4" To 1" Moulding

UNIT PACKAGE: 25



8386

(GM: 4877001)
Nylon

Rear Fender Lower
Moulding Fastener
For 1" To 1-1/4" Moulding

UNIT PACKAGE: 25



8447

(GM: 4886720,
4417599)
Nylon

Front & Rear Door
Moulding Fastener
For 1/2" To 5/8" Moulding

UNIT PACKAGE: 50



8385

(GM: 4877000)
Nylon

Door & Fender Moulding Fastener
For 3/4" To 1" Moulding

UNIT PACKAGE: 25



8400

Nylon

Moulding Fastener
For 1-1/4" to 1-3/4" Moulding

UNIT PACKAGE: 25

Rod End Ball Joints (Male)

Bearing Raceway - Locked in by annular groove-trunnion design. Made of fiber reinforced nylon.

Outer Member (Housing) - Low carbon steel, plated plus dichromate treated for corrosion resistance.

Spherical Ball - Precision make from selected low carbon steel-case hardened - file hard. Plated plus dichromate treated for corrosion resistance.

Left Hand Thread - Available with left hand thread in most sizes. Marked for easy user identification.

Only Available Fully Assembled

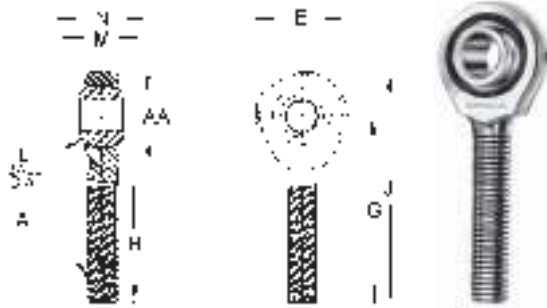

Dimensions

Auveco Part No.	Thread Size (A)	AA	E	G	H	J	L	M	N	Unit Pkg.	Thread
12268 12269	10-32	.189 .191	.625	1.250	.750	1.562	.438	.250	.312	1 1	R L
12270 12271	1/4-28	.250 .252	.750	1.562	1.000	1.937	.516	.281	.375	1 1	R L
12021 12272	5/16-24	.3125 .3145	.875	1.875	1.250	2.312	.625	.344	.437	1 1	R L
12022 12273	3/8-24	.375 .377	1.000	1.937	1.250	2.437	.719	.406	.500	1 1	R L
12485	7/16-20	.4395 .4375	1.125	2.125	1.312	2.687	.812	.437	.562	1	R
12023 12274	1/2-20	.500 .502	1.312	2.437	1.500	3.094	.938	.500	.625	1 1	R L
12024	5/8-18	.625	1.500	2.625	1.625	3.375	1.125	.562	.750	1	R
12486	3/4-16	.752 .750	1.750	2.875	1.750	3.750	1.312	.687	.875	1	R

Rod End Ball Joints (Female)

Bearing Raceway - Locked in by annular groove-trunnion design. Made of fiber reinforced nylon.

Outer Member (Housing) - Low carbon steel, plated plus dichromate treated for corrosion resistance.

Spherical Ball - Precision make from selected low carbon steel-case hardened - file hard. Plated plus dichromate treated for corrosion resistance.

Left Hand Thread - Available with left hand thread in most sizes. Marked for easy user identification.

Only Available Fully Assembled

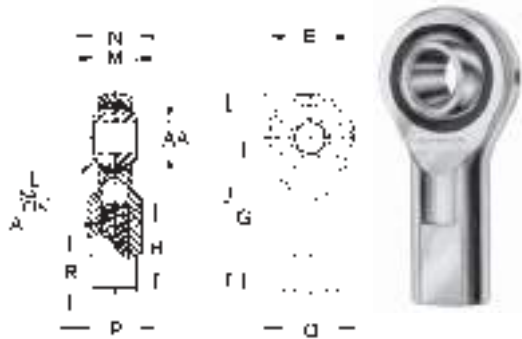

Dimensions

Auveco Part No.	Thread Size (A)	AA	E	G	H	J	L	M	N	O	P	R	Unit Pkg.	Thread
12025 12276	10-32	.189 .191	.625	1.062	.562	1.375	.438	.250	.312	.406	.312	.406	1 1	R L
12026 12277	1/4-28	.250 .252	.750	1.312	.750	1.687	.516	.281	.375	.469	.375	.406	1 1	R L
12027 12278	5/16-24	.3125 .3145	.875	1.375	.750	1.812	.625	.344	.437	.500	.437	.500	1 1	R L
12028 12279	3/8-24	.375 .377	1.000	1.625	.937	2.125	.719	.406	.500	.687	.562	.562	1 1	R L
12487	7/16-20	.4395 .4375	1.125	1.812	1.032	2.375	.812	.437	.562	.750	.625	.625	1	R
12029 12280	1/2-20	.500 .502	1.312	2.125	1.187	2.781	.938	.500	.625	.875	.750	.687	1 1	R L
12281	5/8-18	.625	1.500	2.500	1.500	3.250	1.125	.562	.750	1.000	.875	.875	1	R
12488	3/4-16	.752 .750	1.750	2.875	1.562	3.750	1.312	.687	.875	1.125	1.000	1.000	1	R

Rod End Ball Joints (Male with Stud)

Bearing Raceway - Locked in by annular groove-trunion design. Made of fiber reinforced nylon.

Threaded Stud - Made from medium carbon steel.

Spherical Ball - Precision make from selected low carbon steel-case hardened - file hard. Plated plus dichromate treated for corrosion resistance.

Outer Member (Housing) - Low carbon steel, plated plus dichromate treated for corrosion resistance.

Left Hand Thread - Available with left hand thread in most sizes. Marked for easy user identification.

Only Available Fully Assembled



Dimensions

Auveco Part No.	Thread Size (A)	B	C	D	E	F	G	H	J	K	L	M	N	Unit Pkg	Thread
12290	10-32	.437	.437	.156	.625	.312	1.250	.750	1.562	.189	.438	.250	.312	1	R
12292 12293	1/4-28	.469	.562	.156	.750	.375	1.562	1.000	1.937	.250	.516	.281	.375	1 1	R L
12030	5/16-24	.531	.687	.187	.875	.437	1.875	1.250	2.312	.312	.625	.344	.437	1 1	R
12031 12295	3/8-24	.625	.875	.218	1.000	.500	1.937	1.250	2.437	.375	.719	.406	.500	1 1	R L
12032	1/2-20	.875	1.125	.312	1.312	.625	2.437	1.500	3.094	.500	.938	.500	.625	1	R

Rod End Ball Joints (Female with Stud)

Bearing Raceway - Locked in by annular groove - trunion design. Made of fiber reinforced nylon.

Threaded Stud - Made from medium carbon steel

Spherical Ball - Precision make from selected low carbon steel - case hardened - file hard. Plated plus dichromate treated for corrosion resistance.

Outer Member (Housing) - Low carbon steel, plated plus dichromate treated for corrosion resistance.

Left Hand Thread - Available with left hand thread in most sizes. Marked for easy user identification.

Only Available Fully Assembled



Dimensions

Auveco Part No.	Thread Size (A)	B	C	D	E	F	G	H	J	K	L	M	N	O	P	R	U. P.	The.
12034 12283	10-32	.437	.437	.156	.625	.312	1.062	.562	1.375	.189	.438	.250	.312	.406	.312	.406	1 1	R L
12035 12284	1/4-28	.469	.562	.156	.750	.375	1.312	.750	1.687	.250	.516	.281	.375	.469	.375	.406	1 1	R L
12036 12285	5/16-24	.531	.687	.187	.875	.437	1.375	.750	1.812	.312	.625	.344	.437	.500	.437	.500	1 1	R L
12037 12286	3/8-24	.625	.875	.218	1.000	.500	1.625	.937	2.125	.375	.719	.406	.500	.687	.562	.562	1 1	R L
12491	7/16-20	.844	1.062	.312	1.125	.625	1.812	1.032	2.375	.437	.812	.437	.562	.750	.625	.625	1	R
12038	1/2-20	.875	1.125	.312	1.312	.625	2.125	1.187	2.781	.500	.938	.500	.625	.875	.750	.687	1	R
12288	5/8-18	1.00	1.125	.375	1.500	.750	2.500	1.500	3.250	.625	1.125	.562	.750	1.00	.875	.875	1	R
12492	3/4-16	1.187	1.812	.375	1.750	1.00	2.875	1.562	3.750	.750	1.312	.687	.875	1.125	1.00	1.00	1	R

Damper Control Swivels

The units are made from low carbon steel and are plated and dichromate treated for corrosion resistance. The set screws are made of low carbon steel, plated and dichromate treated for corrosion resistance. Set screws are case hardened. A rubber disc is used in the assembly.

Only Available Fully Assembled

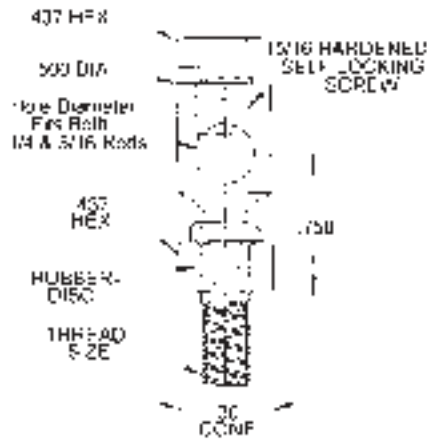

Thread Size	Damper Control Swivels			
	Auveco Part Number Without Nut And Washer	Unit Pkg	Auveco Part Number With Nut And Washer	Unit Pkg.
1/4-28 x 9/16"	12303	2	12047	3
1/4-20 x 7/16"	12304	2	12048	3
1/4-20 x 9/16"	12305	2	12049	3
5/16-24 x 3/4"	12300	2	12307	2

Crank Arms
(12 Gauge Steel)

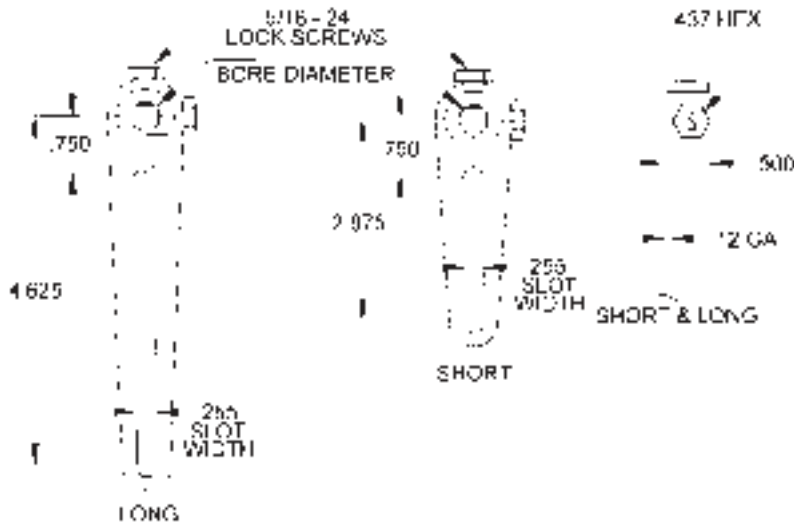

Auveco Part No.	Description	Bore Diameter	Unit Pkg.
12050	Short Series Crank Arm for 3/8" Shaft	.385/.389	1

("Flat Top"-Shurseal)

Materials of construction - Made of low carbon steel with ball studs case hardened. Plated and dichromate treated for corrosion resistance.

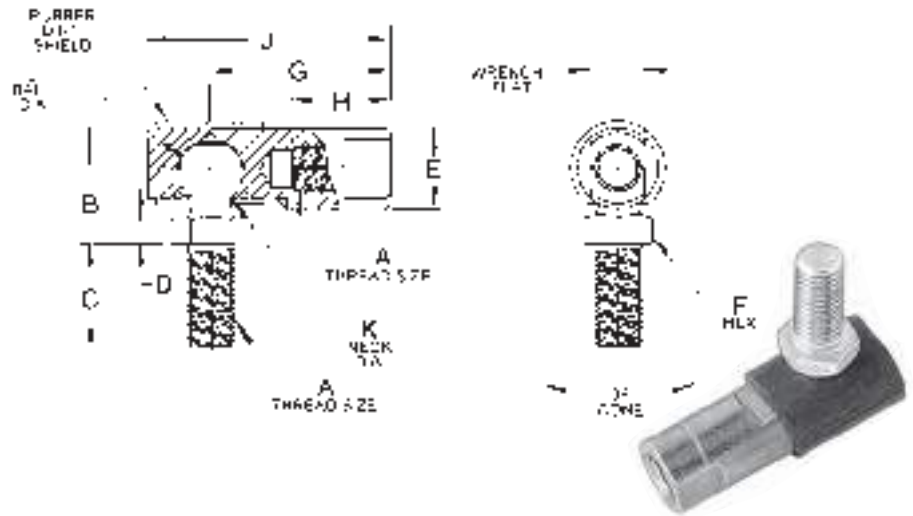

Only Available Fully Assembled

DIMENSIONS

Auveco Part No.	Unit Pkg.	A	B	C	D	E	Wrench Size	F	G	H	J	K	L	Thread
13580	2	10-32	7/16	7/16	1/8	3/8	5/16	5/16	7/8	15/32	1-5/32	.177	.301	R
12039	3	1/4-28	15/32	9/16	1/8	7/16	3/8	3/8	31/32	17/32	1-5/16	.208	.347	R
12040 13590	3 2	5/16-24	17/32	11/16	5/32	1/2	7/16	7/16	1-1/8	19/32	1-9/16	.250	.405	R L
12041	1	3/8-24	11/16	7/8	3/16	5/8	1/2	1/2	1-3/8	13/16	1-13/16	.289	.493	R
12042	1	7/16-20	7/8	1-1/8	1/4	3/4	5/8	5/8	1-15/16	1-1/8	2-1/2	.375	.618	R

Quick Disconnect

"Key Hole" design on retaining sleeve insures positive alignment of sleeve with ball cavity.

Materials of construction - Body and ball are of low carbon steel, with ball studs case hardened. All components except stainless steel spring are plated and yellow dichromate treated for greater corrosion resistance.

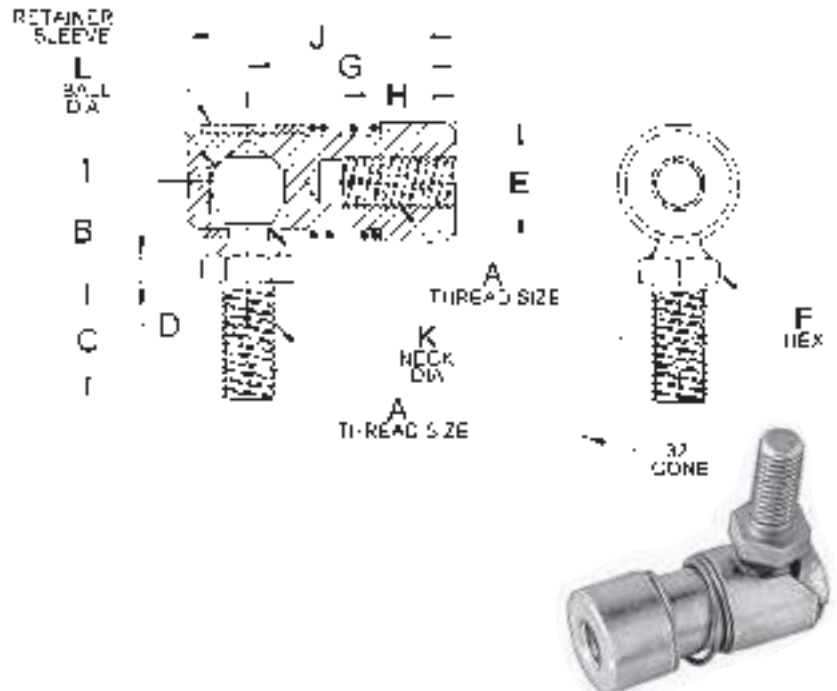

Only Available Fully Assembled

DIMENSIONS

Auveco Part No.	Unit Pkg.	A	B	C	D	E	F	G	H	J	K	L
12044	2	1/4-28	15/32	9/16	1/8	9/16	3/8	31/32	17/32	1-1/4	.192	.347
12045	2	5/16-24	17/32	11/16	5/32	5/8	7/16	1-1/8	19/32	1-29/64	.224	.405
13610	1	3/8-24	11/16	7/8	3/16	3/4	1/2	1-3/8	13/16	1-3/4	.273	.493

BALL JOINT ASSEMBLIES
(Lightweight)



Materials of construction - Made of low carbon steel. Units are plated and dichromate treated for corrosion resistance. A rubber disc is used.

Only Available Fully Assembled.

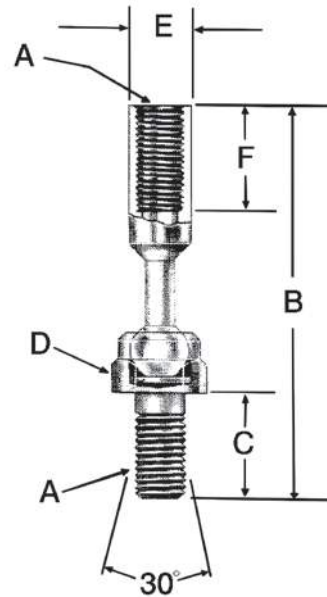

DIMENSIONS

Auveco Part No.	Unit Pkg.	G.M.C. Part No	A	B	C	D	E	F
21533	2	443773	1/4-28	2-3/32	9/16	7/16	5/16	9/16

Disconnecting

Materials of construction - Made of low carbon steel. Both ball stud and ball cavity are case hardened. Plated and dichromate treated for corrosion resistance. The retaining clip is heat treated spring steel, plated for corrosion resistance

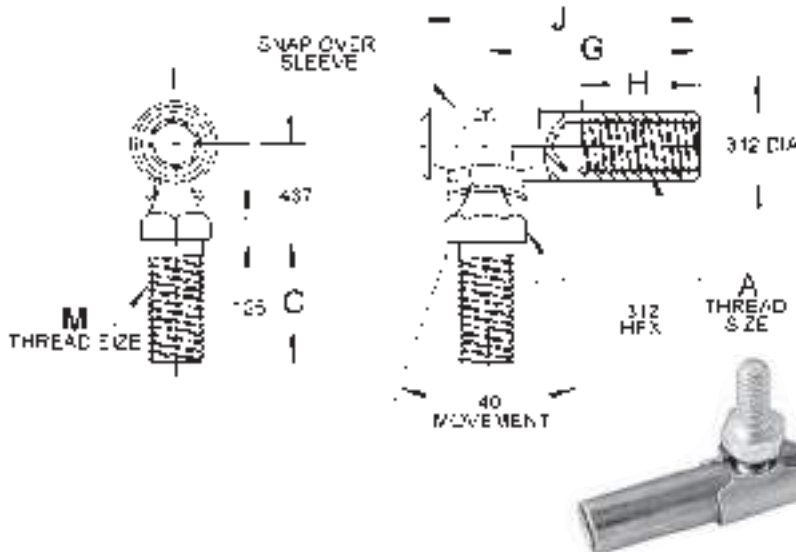

Only Available Fully Assembled

DIMENSIONS

Auveco Part No.	Unit Pkg.	A	C	G	H	J	M
13599	2	10-32NF	7/16	7/8	31/64	1-5/32	10-32NF
13601	2	10-32NF	9/16	7/8	31/64	1-5/32	1/4-28UNF
13600	2	1/4-28UNF	9/16	31/32	17/32	1-1/4	1/4-28UNF

BALL JOINT ASSEMBLIES

Spring Loaded

Materials of construction - Made of low carbon steel. Seat members are made of C1008 steel. Both ball stud and seats are case hardened. Assemblies are plated and dichromate treated for corrosion resistance.

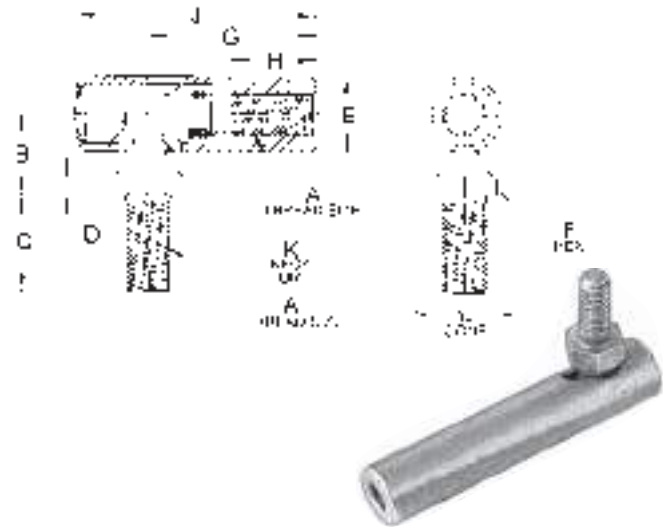

Only Available Fully Assembled.

DIMENSIONS

Auveco Part No.	Unit Pkg.	G.M.C. Part No.	G.M.C. Part No.	A	B	C	D	E	F	G	H	J	K
Spring Loaded													
9866	5	109398	91727	10-32	7/16	7/16	1/8	3/8	5/16	7/8	7/16	1-1/4	.125

("FLAT TOP")

Materials of construction - Made of low carbon steel with ball studs case hardened. Plated and clear dichromate treated for corrosion resistance.

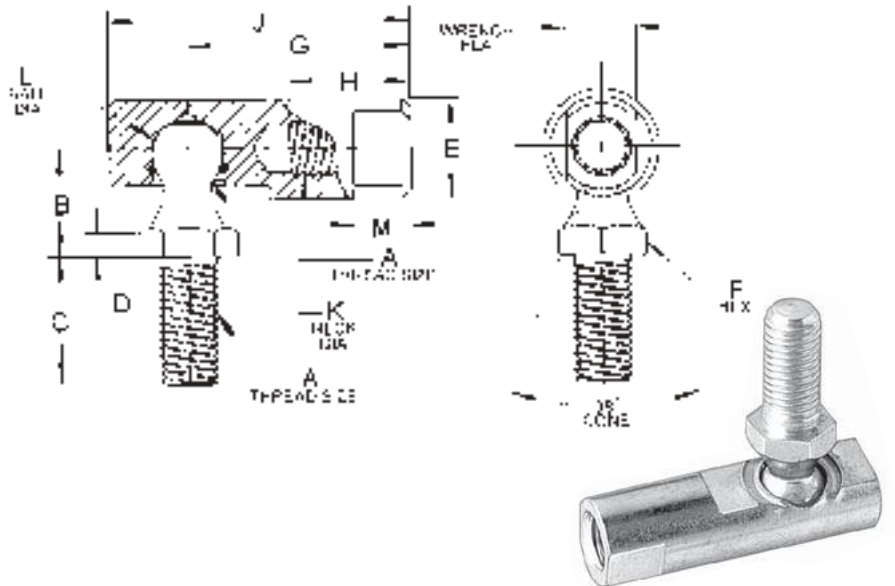

Only Available Fully Assembled.

DIMENSIONS

Auveco Part No.	Unit Pkg.	A	B	C	D	E	Wrench Size	F	G	H	J	K	L	Thread
13581	2	10-32	7/16	7/16	1/8	3/8	5/16	5/16	7/8	15/32	1-5/32	.177	.301	R
13582	2	1/4-28	15/32	9/16	1/8	7/16	3/8	3/8	31/32	17/32	1-5/16	.208	.347	R
13584	2	5/16-24	17/32	11/16	5/32	1/2	7/16	7/16	1-1/8	19/32	1-9/16	.250	.405	R
9869	5	3/8-24	11/16	7/8	3/16	5/8	1/2	1/2	1-3/8	13/16	1-13/16	.289	.493	R
13587	1	1/2-20	7/8	1-1/8	1/4	3/4	5/8	5/8	1-15/16	1-1/8	2-1/2	.375	.618	R

YOKE ENDS & HOSE CLAMPS

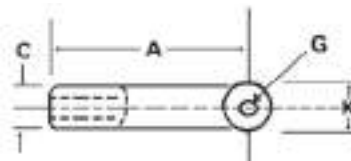
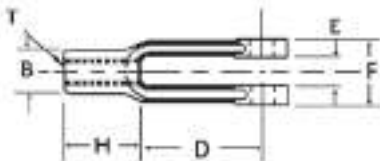

Zinc Finished Drop Forged Yoke Ends
Adjustable

For Clevis Pins
Refer To Page 127

Auveco Part No.	"T" Tap Size	Dimensions In Inches									Unit Pkg.
		A	B	C	D	E	F	G	H	K	
10737	1/4-28	2	7/16	7/16	1-1/4	9/32	5/8	1/4	3/4	1/2	10
10788	1/4-28	2	7/16	7/16	1-1/4	9/32	5/8	1/4	3/4	1/2	2
10738	5/16-24	2-1/4	1/2	1/2	1-7/16	11/32	3/4	5/16	13/16	19/32	10
10789	5/16-24	2-1/4	1/2	1/2	1-7/16	11/32	3/4	5/16	13/16	19/32	2
10739	3/8-24	2-1/2	5/8	5/8	1-5/8	7/16	7/8	3/8	7/8	11/16	10
10790	3/8-24	2-1/2	5/8	5/8	1-5/8	7/16	7/8	3/8	7/8	11/16	2
10740	7/16-20	2-7/8	23/32	23/32	1-7/8	1/2	1	7/16	1	13/16	10
10791	7/16-20	2-7/8	23/32	23/32	1-7/8	1/2	1	7/16	1	13/16	2
10741	1/2-20	3	13/16	13/16	1-7/8	9/16	1-1/8	1/2	1-1/8	15/16	10
10792	1/2-20	3	13/16	13/16	1-7/8	9/16	1-1/8	1/2	1-1/8	15/16	2
10742	5/8-18	4-15/16	1-1/16	1-1/16	3-11/16	11/16	1-3/8	5/8	1-1/4	1-3/16	10
10793	5/8-18	4-15/16	1-1/16	1-1/16	3-11/16	11/16	1-3/8	5/8	1-1/4	1-3/16	2

SINGLE BOND HOSE CLAMPS



Black Nylon

Auveco Part No.	Size	Clamping Range		Unit Pkg.
		Min.	Max.	
19558	1/4"	.246	.290	25
19559	5/16"	.300	.350	25
19560	11/32"	.360	.406	25
19561	13/32"	.410	.468	25
19562	15/32"	.475	.536	25
19564	19/32"	.597	.665	25
19565	43/64"	.670	.780	25
19566	3/4"	.730	.830	25
19568	61/64"	.953	1.093	25
19569	1-1/32"	1.031	1.187	25
19570	1-1/4"	1.250	1.425	10
19571	1-13/32"	1.406	1.610	10
19572	1-19/32"	1.593	1.812	10
19575	2-1/8"	2.120	2.390	10

Spring Action Hose Clamps

Spring Steel, Heat Treated • Phosphate and Paint



Auveco Part No.	Hose O.D.	Color	Max. Dia. Clamp in Free Position	Width	Unit Pkg.
12682	3/8"	Black	.321	5/16"	100
12683	7/16"	Green	.405	5/16"	100
12684	1/2"	Red	.460	5/16"	100
12685	9/16"	Black	.520	5/16"	100
12686	5/8"	Olive	.583	5/16"	100
12688	11/16"	Red	.655	5/16"	100
12689	3/4"	Black	.645	3/8"	100

HOSE CLAMPS

Crimp Type Hose Clamps

Zinc Plated

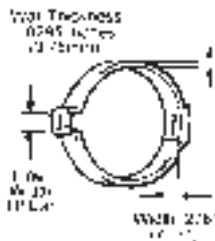

Position clamp on hose Give ear a firm squeeze

For low pressure applications such as automotive, appliance, industrial machinery, etc.

- Easy to Apply
- Simply Slide On and Clamp
- Sizes for all Hoses
- Ideal for Mass Production
- Clamps Tight
- Clamps Quickly
- Only One Simple Motion Needed
- "Full Round" Clamping Pressure
- No Gap Areas to Leak
- Low Profile-Out of the Way
- Avoids Hose Cutting and Abrasion

Part No.	Nominal Size	Inches Closed-Open	mm Closed-Open	Inner Width of Ear		Unit Pkg.
				Inches	mm	
18436	3/8"	.350 - .414	8.9 - 10.5	.197	.5	25
18437	7/16"	.381 - .444	9.7 - 11.3	.197	.5	25
18438	15/32"	.394 - .486	10.4 - 12.3	.197	.6	25
18439	1/2"	.453 - .524	11.4 - 13.3	.236	.6	25
18440	35/64"	.472 - .551	11.9 - 14.0	.256	.65	25
18441	9/16"	.496 - .571	12.6 - 14.5	.236	.6	25
18442	5/8"	.543 - .618	13.8 - 15.7	.236	.6	25
18443	11/16"	.594 - .669	15.1 - 17.0	.236	.6	25
18444	23/32"	.618 - .728	15.7 - 18.5	.354	.9	25
18445	3/4"	.669 - .779	17.0 - 19.8	.354	.9	25
18446	7/8"	.779 - .890	19.8 - 22.6	.354	.9	25
18447	1"	.898 - 1.008	22.8 - 25.6	.354	.9	25

Crimp Type Hose Clamp Tool

18448



For installing and removing Auveco Crimp Type Hose Clamps 18436-18447.

UNIT PACKAGE: 1

Constant Tension Band Hose Clamps



- For Heater & Radiator Hoses
- 1074 Spring Steel
- Black OEM Finish
- Conforms To SAE J1508 & GM 6298M
- Rated At 30 P.S.I.



Auveco Part No.	Clamping Range	Band Width	Unit Pkg.
18127	15.2mm - 18.5mm (5/8" - 23/32")	15mm (19/32")	10
18128	17.8mm - 20.0mm (23/32" - 25/32")	15mm (19/32")	10
18129	22.0mm - 26.0mm (7/8" - 1")	15mm (19/32")	10
18132	37.2mm - 44.5mm (1-15/32" - 1-3/4")	15mm (19/32")	5

HOSE CLAMPS

Wire Type Hose Clamps

To Install and remove wire type hose clamps use Auveco Tool 20902 (See page 727)



Auveco Part No.	Hose Size O.D.	Unit Pkg.	Auveco Part No.	Hose Size O.D.	Unit Pkg.
5354	9/16"	50	5358	15/16"	50
5357	3/4"	50	16603	1-7/8"	10
17086	13/16"	50	16604	2"	10

Hex Slotted Screw-Worm Gear Type-Hose Clamps

All Stainless Steel

Band-Saddle-Screw-Housing

300 Series Stainless (Non-Corrosive)

Screw Is 400 Series (Magnetic) Stainless



Auveco Part No.	Ind. Std. Size	Clamp Range Min.-Max	Hose I.D. 3/16" Wall	Fits Plastic Pipe Size	Band Width	Unit Pkg.
9584	8	7/16" - 1"	5/16" to 1/2"	1/2" to 9/16"	9/16"	10
9585	10	1/2" - 1-1/8"	3/8" to 5/8"	1/2" to 3/4"	9/16"	10
9586	12	1/2" - 1-1/4"	5/8" to 3/4"	1/2" to 3/4"	9/16"	10
18483	16	3/4" - 1-1/2"	3/4" to 7/8"	1" to 1-1/4"	9/16"	10
9587	20	3/4" - 1-3/4"	1" to 1-1/4"	1" to 1-1/4"	9/16"	10
9588	24	1" - 2"	1-1/4" to 1-1/2"	1" to 1-1/2"	9/16"	10
9589	28	1-5/16" - 2-1/4"	1-1/4" to 1-3/4"	1-1/4" to 1-1/2"	9/16"	10
9590	32	1-9/16" - 2-1/2"	1-1/2" to 2"	1-1/2" to 2"	9/16"	10
9591	36	7/8" - 2-3/4"	1-3/4" to 2-1/4"	1-1/2" to 2"	9/16"	10
9592	40	1-1/8" - 3"	2" to 2-1/2"	2" to 2-1/2"	9/16"	10
9593	48	1-5/8" - 3-1/2"	2-1/4" to 3"	2-5/8" to 3"	9/16"	10
9594	52	1-7/8" - 3-3/4"	2-13/16" to 3-3/4"	3"	9/16"	10
9595	72	3-1/8" - 5"	3-3/4" to 4-1/2"		9/16"	10
9596	88	4-1/4" - 6"	4" to 5-1/2"	4"	9/16"	10
9597	96	4-3/4" - 6-1/2"	4-1/2" to 6"		9/16"	10
9598	104	5" - 7"	5-7/8" to 6-1/2"	6"	9/16"	10

Hex Slotted Screw-Worm Gear Type-Hose Clamps

Partial Stainless Steel

300 Series Stainless Steel Band and Saddle

Plated Screw and Housing



Auveco Part No.	Ind. Std. Size	Clamp Range Min.-Max.	Hose I.D. 3/16" Wall	Fits Plastic Pipe Size	Band Width	Unit Pkg.
5347	10	1/2" - 1-1/8"	3/8" to 5/8"	1/2" to 3/4"	9/16"	10
5348	12	1/2" - 1-1/4"	5/8" to 3/4"	1/2" to 3/4"	9/16"	10
18482	16	3/4" - 1-1/2"	3/4" to 7/8"	1" to 1-1/4"	9/16"	10
5349	20	3/4" - 1-3/4"	1" to 1-1/4"	1" to 1-1/4"	9/16"	10
5350	28	1-5/16" - 2-1/4"	1-1/4" to 1-3/4"	1-1/4" to 1-1/2"	9/16"	10
5351	32	1-9/16" - 2-1/2"	1-1/2" to 2"	1-1/2" to 2"	9/16"	10
5352	36	7/8" - 2-3/4"	1-3/4" to 2-1/4"	1-1/2" to 2"	9/16"	10
9357	48	1-5/8" - 3-1/2"	2-1/4" to 3"	2-1/4" to 2-3/4"	9/16"	10
9599	52	1-7/8" - 3-3/4"	2-13/16" to 3-3/4"	3"	9/16"	10
9358	72	3-1/8" - 5"	3-3/4" to 4-1/2"		9/16"	10
9600	88	4-1/4" - 6"	4" to 5-1/2"	4"	9/16"	10
9601	96	4-3/4" - 6-1/2"	4-1/2" to 6"		9/16"	10



No. 4

9324

Mini Clamp
Stainless Steel Band
With Double Plated Hex Head
Steel Screw
Band Width 5/16"
Minimum Range 1/4" - Maximum Range 5/8"

UNIT PACKAGE: 10



No. 6

10221

Mini Clamp
Stainless Steel Band
With Double Plated Slotted
Head Steel Screw
Band Width 5/16"
Minimum Range 1/2" - Maximum Range 7/8"

UNIT PACKAGE: 10

Norma Torro (European Style) Hose Clamps DIN 3017 • Stainless Steel Band & Housing • Zinc & Yellow Steel Screw



Unique off-set non-welded design of the housing provides resistance to over-tightening damage to the hose. The short housing saddle gives a smooth underside ensuring high sealing efficiency. These clamps are original equipment on both domestic and import vehicles. They are particularly suited for fuel, vacuum, water, emission and heater hoses and can be used with silicone hoses.

Auveco Part No.	Clamping Range	Hex Size	Band Width	Unit Pkg.
16868	8mm-12mm (5/16"-1/2")	6mm*	8mm (5/16")	10
16869	10mm-16mm (3/8"-5/8")	6mm*	8mm (5/16")	10
16870	12mm-18mm (1/2"-3/4")	6mm*	8mm (5/16")	10
16871	8mm-16mm (5/16"-5/8")	6mm	9mm (11/32")	10
16872	12mm-20mm (1/2"-3/4")	6mm	9mm (11/32")	10
16873	16mm-25mm (5/8"-1")	6mm	9mm (11/32")	10
16874	20mm-32mm (3/4"-1-1/4")	6mm	9mm (11/32")	10
16875	25mm-40mm (1"-1-5/8")	6mm	9mm (11/32")	10
16876	30mm-45mm (1-3/16"-1-3/4")	6mm	9mm (11/32")	10
16877	32mm-50mm (1-1/4"-2")	6mm	9mm (11/32")	10
16878	40mm-60mm (1-5/8"-2-3/8")	6mm	9mm (11/32")	10
19252	50mm-70mm (1-31/32" - 2-3/4")	6mm	9mm (11/32")	10
19253	60mm-80mm (2-3/8" - 3-1/8")	6mm	9mm (11/32")	10
19254	70mm-90mm (2-3/4" - 3-9/16")	6mm	9mm (11/32")	10

*Phillips Hex Drive



16879

Flexible Nut Driver
For 6mm Hex
Fits Auveco Hose Clamps
16868-16878 and 19252 - 19254

UNIT PACKAGE: 1

Type "G" Miniature Hose Clamp



These clamps fit all standard automotive fuel injection hoses. Approved for all O.E.M. applications
Zinc Plated



Auveco Part No.	Clamp Range Min.-Max	Hose I.D.	Band Width	Unit Pkg.	Auveco Part No.	Clamp Range Min.-Max.	Hose I.D.	Band Width	Unit Pkg.
16766	8mm-9.5mm 5/16"-13/32"	5/32"	9mm (11/32")	10	15861	12.5mm-14.5mm 1/2" - 19/32"	5/16"	9mm (11/32")	10
16767	9.5mm-11.5mm 3/8"-15/32"	7/32"	9mm (11/32")	10	15862	13.5mm-15.5mm 17/32"-5/8"	3/8"	9mm (11/32")	10
15860	10.5mm-12.5mm 7/16"-1/2"	1/4"	9mm (11/32")	10	21256	15mm-17.5mm 19/32"-11/16"	3/8"	9mm (11/32")	10

TUBING CLAMPS



Natural Nylon Tubing Clamps

Auveco Part No.	Hole Dia.	Width	Tube Dia.	Unit Pkg.
15525	3/16"	3/8"	1/8"	50
15526	3/16"	3/8"	3/16"	50
9246	3/16"	3/8"	1/4"	25
9247	3/16"	3/8"	5/16"	25
9248	3/16"	3/8"	3/8"	25
9249	3/16"	3/8"	1/2"	25
9250	3/16"	1/2"	5/8"	25
9251	3/16"	1/2"	3/4"	25
9252	3/16"	1/2"	1"	25

Steel Clamps With Neoprene Jacket



Zinc Plated
UNIT PACKAGE: 10

Auveco Part No.	Tube Size	Band Width	Mounting Hole Diameter
20502	1/4"	1/2"	17/64"
20503	3/8"	1/2"	17/64"
20504	1/2"	1/2"	17/64"
20505	5/8"	1/2"	17/64"
20506	3/4"	1/2"	17/64"
20507	7/8"	1/2"	17/64"
20508	1"	1/2"	17/64"
20509	1-1/4"	1/2"	17/64"
20510	1-1/2"	1/2"	17/64"
20511	1-3/4"	1/2"	17/64"
20512	2"	1/2"	17/64"

Aluminum Tubing Clamps

With Neoprene Jacket



Auveco Part No.	Hole Dia.	Width	Tube Dia.	Unit Pkg.
17361	5/32"	3/8"	1/4"	15
17362	5/32"	3/8"	5/16"	15
17363	5/32"	3/8"	3/8"	15
17364	5/32"	3/8"	1/2"	15
17366	5/32"	1/2"	3/4"	15
17367*	5/32"	1/2"	7/8"	15
17368	5/32"	1/2"	1"	15

*Vinyl Dipped



Insulated "Half" Clamps
Galvanized
Coated With Black Vinyl (1/32" Thick)

Auveco Part No.	Inside Diameter	Hole Diameter	Center To Center	Hole Center To End	Top of Radius To Base	Gauge	Width	Unit Pkg.
10608	3/16"	7/32"	7/16"	1/4"	5/32"	.032	1/2"	25
10609	1/4"	7/32"	1/2"	1/4"	7/32"	.048	1/2"	25
10610	5/16"	9/32"	17/32"	5/16"	9/32"	.048	5/8"	25
10611	3/8"	9/32"	9/16"	5/16"	11/32"	.048	5/8"	25
10612	7/16"	9/32"	5/8"	5/16"	13/32"	.060	5/8"	25
10613	1/2"	9/32"	11/16"	5/16"	15/32"	.060	5/8"	25
10614	5/8"	9/32"	13/16"	5/16"	9/16"	.060	5/8"	25
10615	3/4"	9/32"	7/8"	5/16"	11/16"	.060	5/8"	25

STEEL INSULATED CLOSED CLAMPS

Sec. 25

Furnished Open
Galvanized
Coated With Black Vinyl (1/32" Thick)

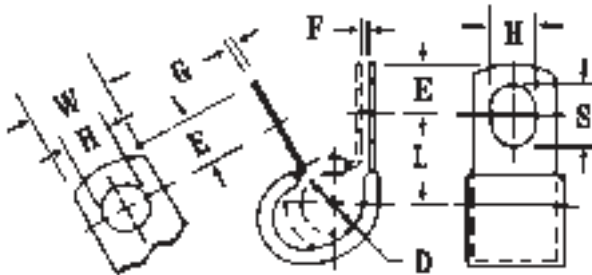

UNIT PACKAGE: 25 PCS.

Auveco Part No.	D	H	L	W	E	F	G	S
	Inside Diameter	Hole Diameter	Center to Center	Width	Hole Center To End	Gap	Gauge	Slot Length
Small Hole Clamps								
17087	3/16"	9/32"	1/2"	1/2"	5/16"	1/32"	.032"	3/8"
9381	1/4"	9/32"	17/32"	1/2"	5/16"	1/32"	.032"	3/8"
9382	5/16"	9/32"	9/16"	1/2"	5/16"	1/32"	.032"	3/8"
9383	3/8"	9/32"	19/32"	1/2"	5/16"	1/16"	.032"	3/8"
9384	1/2"	9/32"	21/32"	1/2"	5/16"	1/16"	.048"	3/8"
9385	5/8"	9/32"	23/32"	1/2"	5/16"	1/16"	.048"	3/8"
9386	3/4"	9/32"	25/32"	1/2"	5/16"	1/16"	.048"	3/8"
9387	7/8"	9/32"	27/32"	1/2"	5/16"	1/16"	.048"	3/8"
9388	1"	9/32"	29/32"	1/2"	5/16"	1/16"	.048"	3/8"
Large Hole Clamps								
10598	1/4"	13/32"	21/32"	3/4"	7/16"	1/32"	.032"	1/2"
10599	5/16"	13/32"	11/16"	3/4"	7/16"	1/32"	.032"	1/2"
10600	3/8"	13/32"	23/32"	3/4"	7/16"	1/16"	.032"	1/2"
10601	1/2"	13/32"	25/32"	3/4"	7/16"	1/16"	.048"	1/2"
10602	5/8"	13/32"	27/32"	3/4"	7/16"	1/16"	.048"	1/2"
10603	3/4"	13/32"	29/32"	3/4"	7/16"	1/16"	.048"	1/2"
10604	7/8"	13/32"	31/32"	3/4"	7/16"	1/16"	.048"	1/2"
10605	1"	13/32"	1-1/32"	3/4"	7/16"	1/16"	.048"	1/2"
10606	1-1/4"	13/32"	1-5/32"	3/4"	7/16"	1/16"	.048"	1/2"
10607	1-1/2"	13/32"	1-9/32"	3/4"	7/16"	1/16"	.048"	1/2"
17588*	1-3/4"	13/32"	1-13/32"	3/4"	7/16"	1/16"	.048"	1/2"
17589*	2"	13/32"	1-9/16"	3/4"	7/16"	1/16"	.048"	1/2"

* Unit Package: 10

Steel Uninsulated Closed Clamps Furnished Open

Galvanized
UNIT PACKAGE: 25 Pcs.

9389	1/4"	9/32"	1/2"	1/2"	5/16"	1/32"	.032"	3/8"
9391	3/8"	9/32"	9/16"	1/2"	5/16"	1/32"	.032"	3/8"

STOP EXCESSIVE COOLANT CONSUMPTION OR LEAKAGE!!!!

20574

Engine Manifold
Repair Kit



UNIT PACKAGE: 1 Kit

2003 - 1995 GM vehicles with 3.8 L series 2 engines (VIN K - RPO L36) have been experiencing excessive coolant consumption or coolant leakage near or under the throttle body and intake manifold. This is caused when the EGR tube on the lower manifold degrades the composite material of the upper intake plenum around the passage area between the two part manifold. Once the composite material is degraded, it becomes porous and allows the coolant areas on either side of the EGR passage to leak coolant either internally or externally. If it leaks internally into the intake manifold and then the cylinders, it can result in "hydro-lock" of the engine. A simple coolant leak has resulted in a major problem that as best requires changing the spark plugs and oil in order to start the engine. That doesn't correct the cause of the problem though.

Until now, the solution has been to replace the upper plenum and lower manifold at a retail cost of \$1200 - \$1400 for parts and labor. Yet that alone does not correct the root cause of the problem. Our **20574 repair kit** offers an inexpensive but highly effective and permanent solution. Here are the steps involved:

1. Remove the upper intake manifold.
2. Remove the EGR tube from the bottom plenum.
3. Install our new EGR port tube.
4. Use epoxy supplied with our repair kit to install our new adapter bushing in the upper plenum.
5. Reinstall the upper intake manifold.
(Detailed instructions are included with the kit)

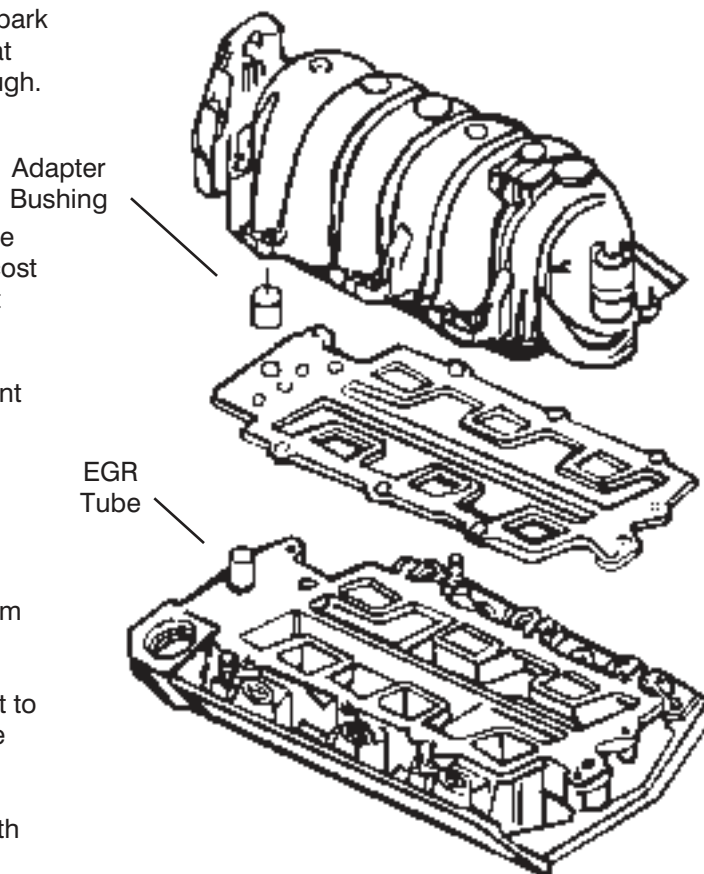

As an added benefit, the smaller diameter of our EGR port tube creates an air space between the repaired (with adapter bushing) upper plenum and the new EGR port tube. This air space insulates the composite material of the plenum from further damage.

Natural Color



Part No. **1001**

10.5 Fluid Ounces Per Cartridge
(Green Colored Cartridge)

UNIT PACKAGE: 10 Cartridges

For use as a water and dust seal on exterior and interior body surfaces. New improved formula allows for a longer open time so it can be tooled for several minutes after being applied. Cures to a firm abrasion resistant seal with no cracks or peeling. Can be air dried or force dried and then painted within 30 minutes

Stands up on vertical surfaces and won't crack even in large seams. Ideal for drip molds, interior trunk welds, exterior body seam welds and many other body seam areas. Possesses excellent flexibility properties so it will not harden or become brittle.

Excess sealer and smears can be cleaned up with a suitable solvent before sealer dries. Sealer surface accepts all paints and must be painted. Shelf life is 6 months.

Seam-N-Joint Sealer

Natural Color



Part No. **1002**

11 Fluid Ounces Per Cartridge
(Silver Colored Cartridge)

UNIT PACKAGE: 10 Cartridges

Premium quality, fast setting seam-n-joint sealer with superior adhesion for interior and exterior automotive applications (except windshields). Its self-leveling qualities make it an excellent sealer on quarter panel seams, trunk seams, wheel house seams, floor seams, cowl seams and door skins.

1002 smooths easily so rough edges and fingerprints disappear. Possesses superior flexibility properties thus eliminating any cracking or peeling. Skin time is 1-2 minutes. Can be painted with any type of paint in 30-60 minutes. Shelf life is 6 months.

Distributors: Auveco 1001 and 1002 can be combined for price breaks and prepaid freight.

EPOXY REPAIR KITS

Flexible Setting Epoxy Repair Kit

Part No. **1003**

UNIT PACKAGE: 2 Tubes: 1 Each Of Part 1 (Dark Gray) and Part 2 (White)
(16 oz. Kit)



A Flexible Epoxy Repair Compound for the Auto Body Shop which sets in 6-8 minutes. It has strong adhesion to all surfaces plus excellent paint adhesion.

Make difficult repairs to flexible expensive parts in one hour
Easy to use 2 part equal mix

Non brittle-excellent feather edging
Retains flexibility when cured
Chemical resistant-non shrinking-tough and durable

Use to repair cuts, holes, tears and gouges on rubber bumpers, flexible header panels, and filler strips (exc. polyethylene and polypropylene).

Shelf life: 12 months

Hard Setting Epoxy Repair Kit

Part No. **1004**

UNIT PACKAGE: 2 Tubes: 1 Each Of Part 1 (Light Gray) and Part 2 (White)
(16 oz. Kit)



A Rigid Setting Epoxy Repair Compound for the Auto Body Shop which sets in 6-8 minutes. It is extremely strong yet not brittle. It cures rapidly in any thickness, has excellent paintability and is chemical resistant.

Sandable in 30 minutes
Easy to use 2 part mix

Strong-excellent feather edging
Difficult repairs made in minutes

Use to repair header panels, carburetors, batteries, gas tanks, rubber bumpers, and filler strips (exc. polyethylene and polypropylene)

Use in industry or home-boats-tools-wood-aircraft-sporting equipment-ceramics.

Shelf life: 12 months



Auveco Part No. **1007** - 1 Tube (4 oz.)

Auveco Part No. **1008** - 1 Case (24-4oz. tubes)

Hardens Like Steel in 20 Minutes

Fix-it Quick will plug or seal practically anything that leaks, it will patch holes and cracks, mend almost anything that is broken. It is excellent for rebuilding or fabricating parts and as an all purpose adhesive for metals, wood, glass, masonry, ceramics and many plastics. Also, it can be drilled, tapped, filed, sanded and painted like metal. Sets steel hard in 20 minutes.

Hints For Use

- FixitQuick adheres to most surfaces. Best results will be achieved if area is first roughened by sanding or filing to clean and prepare surface.
- Starts to harden 2 minutes after mixing. Repair should be in place before hardening starts.
- A smooth finish can be obtained by rubbing with wet finger or damp cloth before hardening begins.
- FixitQuick can be drilled, filed, tapped sanded and machined after one hour of curing (hardening).
- Can be painted immediately, even before full hardening.
- FixitQuick can be used under water. Mix as usual and use the polyethylene wrapper, so material will not stick to hands as the FixitQuick is being forced onto the wet surface.
- Not recommended for use on polyethylene and polypropylene.
- Wash hands thoroughly with soap and water after using FixitQuick.

Mixing Directions

1. Break off required portion of material.

2. Twist and knead until uniform color is achieved-no streaks.

3. Apply At Once to surface. (2 minute work life).

4. Remove excess before it hardens.

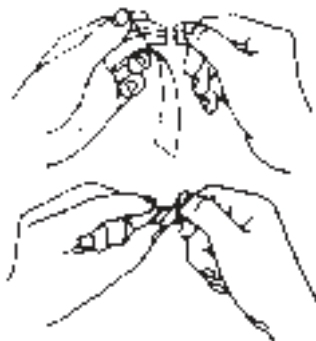

Infinite Uses

U.S.D.A. Authorized

Plumbing Repairs - Sink traps, oil and water tanks, pipe joints, drain leaks, etc.

Electrical - Use in place of tape, ceramic connectors, knobs, etc.

Ceramic Repair - Cracked porcelain wall tile, floor tile, etc.

Auto Repair - Metal Strips, small dent repairing, fuel tank, radiators, etc.

Underwater Repair - Concrete swimming pools, fish tanks, etc.

Custom Formed Gaskets - For permanent sealing and bonding.

Home Repairs - Dethreaded screws in wood or metal, picture hanging, light fixture installation, fixing loose rungs and legs on furniture, air duct leaks, etc.



Safe for lines carrying potable water.

Physical Properties

Density	15.8 lb./gal. (1.9gm/cm ³)
Compression Strength	18,000 psi
Tensile Strength	6,000 psi
Modulus of Elasticity	600,000 psi
Shear Strength	700 psi
Izod Impact	0.3 ft.-lb/in. of notch
Hardness (Shore D)	85
Maximum Use Temperature	300°F (149°C)

Electrical Properties

Volume Resistivity	5 x 10 ohm-cm
Dielectric Strength	400 volts/mil @ 0.125 in.

WARNING: Harmful if swallowed, Eye irritant. Contains epoxy and amine resins. Keep away from children. If swallowed, call physician. For eyes, flush with water and call physician.

MISCELLANEOUS ITEMS

Solder Paste

Works With The Head Of A Match, Lighter, Soldering Iron Or Torch.

Five times stronger than ordinary Solder. Provides strength without the distortion of high temperature brazing.



1) Apply Solder Paste



2) Apply heat until paste begins to bubble



3) Solder will solidify



20409

Silver Bearing Solder Paste

For Ferrous and Non-Ferrous Metals: steel, cast iron, stainless steel, brass, bronze, nickel, platinum, chrome, monel, galvanized, gold & silver. Auto electrical systems, circuit boards, etc. Flows freely at 430° F. Tensile Strength: 10,000 to 25,000 PSI. 7.1 grams syringe

UNIT PACKAGE: 1

20410

Copper Bearing Lead-Free Solder Paste

For use with copper. Also works on brass, stainless steel, nickel and bronze. Does not contain any lead, cadmium or antimony. Flows freely at 430° F. Tensile strength: 10,000 to 25,000 PSI. 14.7 grams syringe

UNIT PACKAGE: 1

Weld Pins

Round Head • Copper Plated Steel

By welding these pins to a damaged body panel, a body shop technician can use a gripping tool to pull the dent out of the panel.



Pin Diameter: 2mm (.080")
Length: 2"
Head Diameter: .145"

19095 UNIT PACKAGE: 100
19096 UNIT PACKAGE: 250
19097 UNIT PACKAGE: 500



Pin Diameter: 2.5mm (.098")
Length: 2"
Head Diameter: .175"

19098 UNIT PACKAGE: 100
19099 UNIT PACKAGE: 250
19100 UNIT PACKAGE: 500

WELDING BLANKET
Part No. 21083



A 6 ft. x 6 ft. lightweight, soft and flexible welding blanket for draping over equipment or floor surfaces in welding areas, or as a vertical shield to protect from the spray of sparks, spatter and slag. Our fire and heat resistant welding blankets are made with a carbon fiber fabric that was developed from NASA technologies. The carbon fibers can withstand temperatures of 1800° F from contact with hot metal, weld spatter or the welding flame for short durations but should not be exposed to temperatures of 200° F for extended periods as the carbon fibers will break down. The blankets are easy to clean; just shake, vacuum or use compressed air to blow metal particles out.

UNIT PACKAGE: 1

MOULDING TAPE

For Mounting Exterior Trim, Side Mouldings, Emblems & Nameplates



- *Acrylic foam tape with an aggressive, high performance adhesive on both sides.
- *Works on all types of plastic mouldings & emblems
- *Will not crack or dry out
- *Will not absorb water
- *Will not migrate in hot weather

21074

.045" thick x 3/16" wide x 60 ft.

UNIT PACKAGE: 1 Roll

21075

.045" thick x 1/2" wide x 60 ft.

UNIT PACKAGE: 1 Roll

21076

.045" thick x 7/8" wide x 60 ft.

UNIT PACKAGE: 1 Roll

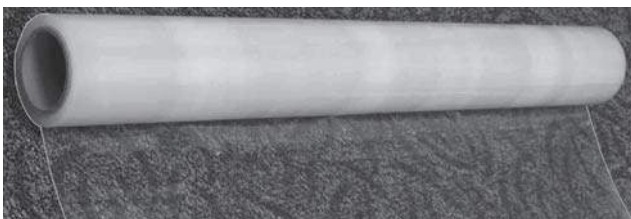

WEATHER-SEAL WRAP

Our Weather-Seal Wrap is a clear, plastic film that has an adhesive on one side that is strong enough to hold the wrap in place on almost any surface and seal out contaminants, yet it can be easily removed without pulling off paint, leaving adhesive residue or damaging the surface. With it you can seal out rain, snow, wind and dirt when windshields or door glass has been broken. In addition, Weather-Seal Wrap can be used to protect vehicle carpet and upholstery from soiling and spills. Apply it to paint booth walls and prevent over spray from discoloring white walls. Weather-Seal Wrap has 3 mils of plastic protection to preserve finishes that it covers so it can also be used as a temporary, protective coating against light abrasions.

21077

24" wide x 200 ft. long

UNIT PACKAGE: 1 Roll

21078

36" wide x 200 ft. long

UNIT PACKAGE: 1 Roll

Plastic Renew® Automotive Plastic & Rubber Restoring Kit



20699

Plastic Renew is a complete plastic and rubber restoring kit. Fading and discoloring are removed by using the steel wool supplied in the kit. Plastic Renew is applied with the applicator towel. Two to three coats of Plastic Renew brings out a brilliant shine that will last for years. This product will not come off with normal washing. One kit completely shines the interior (trim, dash, consoles & door panels) and exterior (mirrors, bumpers & running boards) of most full-sized vehicles.

Not for use on tires.

UNIT PACKAGE: 1 Kit

Plastic And Headlight Resurfacer/Protector

20791



Don't compromise when it comes to safety. Yellowed or cloudy headlights impair night vision. Use of this product on yellowed or discolored headlights will significantly increase the clarity of the lens giving the driver the ability to see better at night. 3 easy steps and about 15 minutes is all it takes to restore most headlights to a like-new appearance that lasts. In addition, it may be used safely on most types of plastics, windshields and more.

Kit Includes: Complete instructions, Pretreatment, Water Base Pretreatment, Oxidation Remover, Shine Restorer/Protector (Increases shine, seals & protects), gloves, sanding sheets, and lint free paper towels.

UNIT PACKAGE: 1 Kit

Trunk/Vibration/Sound Dampening Pads



16506

12" x 12" x .060" thick pads with adhesive backs. Can be cut to shape and painted for easy installation. The clear vinyl sheet on the black side must be removed before painting. Meets GM specification #2747M.

UNIT PACKAGE: 6

Vinyl Gloves

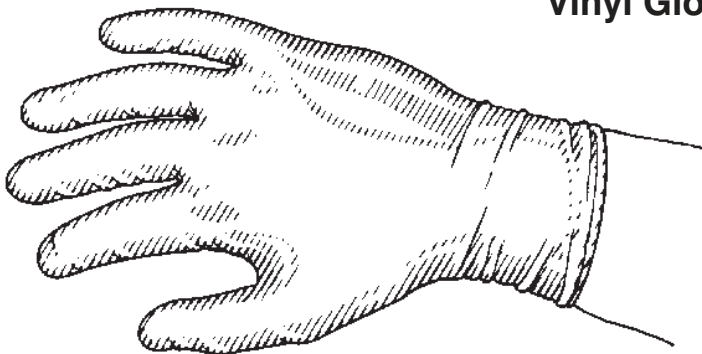

19551

- Large Size
- Form Fitting Fits Right or Left Hand
- Lightly Dusted With Corn Starch
- Non-Sterile
- Not For Immersion In Chemicals

UNIT PACKAGE: 100 Gloves (50 pairs)

**BLUE NITRILE GLOVES
CHEMICAL RESISTANT**



- *4 MIL Non-Latex
- *Puncture Resistant
- *Fits right or left hand

- *Secure Grip - Wet or Dry
- *Powder Free
- *Hypoallergenic

Nitrile is resistant to chemicals commonly found in auto, auto body and glass shops including solvents, parts cleaners, paint thinners, lacquers, urethane, enamel, epoxy resins and sealants

- | | | |
|--------------|-------------------|-------------------------------------|
| 20689 | Size: Medium | Unit Package: 100 Gloves (50 pairs) |
| 20690 | Size: Large | Unit Package: 100 Gloves (50 pairs) |
| 20691 | Size: Extra Large | Unit Package: 100 Gloves (50 pairs) |



PAINTER'S GLOVES Extra Long

- *Heavy Duty Applications
- *Textured Fingers & Palm
- *Flock Lined For Added Comfort

- *Superior Protection Of Nitrile
- *Secure Grip - Wet or Dry
- *Strong - Durable - Reusable

20692 Size: Large
20693 Size: Extra Large

Unit Package: 1 Pair
Unit Package: 1 Pair



STRONGHOLD GLOVES Micro-Knit With Nitrile Palms

- *Superior Dexterity & Durability
- *"Breathable" Micro-Knit
- *Machine Washable

- *Excellent Gripping Power
- *Super Lightweight
- *Seamless Comfort

20694 Size: Large
20695 Size: Extra Large

Unit Package: 1 Pair
Unit Package: 1 Pair



Rough Service Long Life Light Bulbs

The Rough Service bulb features a special filament that withstands shock and vibration. It was designed exclusively for the automotive service industry. The brass base eliminates "freezing" or corroding in the socket; however, it will explode if it comes in contact with a liquid.

16570
Rough Service
75 Watt
UNIT PKG: 6

16571
Rough Service
75 Watt
UNIT PKG: 120
(1 Case of
20 Six-Paks)



Super Toughcoat Long Life Light Bulbs

Super Toughcoat's amazing silicon coating makes it the safest, sturdiest light bulb ever developed. Patented coating protects personnel and products from shattered glass caused by impact, dropping, unusual stress, contact with liquids and thermal shock. Brass base eliminates "freezing" or corroding in the socket.

16574
Super Toughcoat
75 Watt
UNIT PKG: 6

16575
Super Toughcoat
100 Watt
UNIT PKG: 6

MISCELLANEOUS ITEMS

Acid Brushes



Tin Handle Horse Hair Bristles

Auveco Part No.	Width	Trim	Length	Unit Pkg.
15793	1/4"	3/4"	6"	1 Gross
15794	3/8"	3/4"	6"	1 Gross
15795	1/2"	13/16"	6"	1 Gross
15796	9/16"	7/8"	6"	1 Gross
15798	3/4"	1"	6-3/8"	1 Gross

Chip Brushes



Wood Handle Natural Bristles

Auveco Part No.	Width	Trim	Unit Pkg.
15800	1-1/2"	1-5/8" x 5/16"	5
15801	2"	1-1/2" x 5/16"	4

Chip & Dope Brush

Wood Handle Horse Hair Bristles



Auveco Part No.	Width	Trim	Length	Unit Pkg.
15799	11/16"	1-1/8"	7"	25

Steel Wire Scratch Brushes

Wood Handle



Type 1



Type 2

Auveco Part No.	Type	Size of Block	Rows	Trim	Wire	Unit Pkg.
15803	1	14" x 1"	3 x 19	1-3/16"	33 Gauge Steel	1
15805	2	10" x 1-1/8"	4 x 16	1-3/16"	33 Gauge Steel	1

Bin Labels

(Refer To Page 284 For Additional Information)

2" x 3/4" Pressure Sensitive Bin Labels Covering Popular Size U.S.S., S.A.E. And Metric Fasteners.
36 Labels Per Each 6-1/4" x 9" Page.



- 15531 U.S.S. Fasteners -6 Pages
- 15532 S.A.E. Fasteners -6 Pages
- 14773 Miscellaneous Fasteners -6 Pages
- 14774 Metric Fasteners -9 Pages
- 14775 Blank Labels -5 pages
- 15533 Bin Label Assortment
1 Each Of 15531, 15532,
14773, 14774, & 14775

All Packed 1 Set



Toggle Bolts Spring Wing Type

Auveco Part No.	Head Style	Screw Dia.	Thread Size	Use Drill	Unit Pkg
10011	Mushroom	1/8"	6-32 x 3"	3/8"	10
10012	Mushroom	1/8"	6-32 x 4"	3/8"	10
10013	Round Slotted	3/16"	10-24 x 3"	9/16"	10
10014	Round Slotted	3/16"	10-24 x 4"	9/16"	10
10018	Round Slotted	1/4"	1/4-20 x 4"	3/4"	10

Plastic Screw Anchors



Auveco Part No.	Screw Size	Hole Size	Length	Color	Unit Pkg
9986	3/8"	7/16"	3"	Gray	10



Hammer Drive Anchors All Steel

Auveco Part No.	Size	Unit Hole Size	Pkg
12858	1/4" x 3/4"	1/4"	25
12859	1/4" x 1"	1/4"	25
12860	1/4" x 1-1/4"	1/4"	10
12861	1/4" x 1-1/2"	1/4"	10
12862	1/4" x 2"	1/4"	10

Nylon Anchor Steel Nail



Auveco Part No.	Size	Unit Head Style	Pkg
12870	1/4" x 1"	Mushroom	25



Hex Nut Masonry Anchor

Auveco Part No.	Hole Size	Effective Anchor Length	Fastens Material Up to	Unit Pkg
12875	3/8"	3"	1-3/4"	10



Hollow Wall Anchor Drive Type

Auveco Part No.	Size	Wall Thickness	Drill Size	Unit Pkg
12890	1/8" Long	5/8" to 7/8"	1/4"	10



Plastic Anchors

Auveco Part No.	Screw Size	Drill Size	Unit Pkg
10005	#4-#8	3/16"	50
12851	#6-#10	3/16"	50
10006	#10-#12	1/4"	50
12852	1/4"-5/16"	5/16"	50



Machine Screw Anchor Rust Proof Type

Auveco Part No.	Screw Size	Drill Size	Unit Pkg
9999	1/4"-20	1/2"	25

Note: One Setting Tool Included w/Each Box.

Lag Screw Shields



Auveco Part No.	Screw Size	Length	Drill Size	Unit Pkg
9992	1/4"	Long	1/2"	10
9994	3/8"	Long	5/8"	10



Hollow Wall Anchors

Auveco Part No.	Size	Wall or Surface Thickness	Unit Pkg
10008	1/8" Long	5/8" to 1-1/4"	10
10009	3/16" Short	1/8" to 5/8"	10
10010	3/16" Long	5/8" to 1-1/4"	10
12831	1/4" Short	1/8" to 5/8"	10
12832	1/4" Long	5/8" to 1-1/4"	10

MISCELLANEOUS ITEMS



**Hollow Wall Toggle
With Screws**

Auveco Part No.	Toggle Size	Screw Length	Hole Size	Unit Pkg.
12833	1/8"	2"	3/8"	10



**Screw Pin
Anchor Shackles**

Galvanized Weldless Drop Forged Stud With Alloy Pin.

Auveco Part No.	Size	Length Inside	Dimensions Between Eyes	Diam Pin	Safe Working Load (Tons)	Unit Pkg.
12184	5/16"	1-1/4"	9/16"	3/8"	3/4"	1
12187	1/2"	2"	7/8"	5/8"	2"	1



**Wire Rope Thimble
Galvanized**

Auveco Part No.	For Diam. Rope	Outside Width Across Score	Width Inside	Length Overall	Unit Pkg.
12192	1/8"	9/32"	23/32"	1-3/4"	10



"Nipper" Wire Rope Clip

Galvanized Malleable Iron Base
Zinc Plated Stud U-bolt

Auveco Part No.	For Diam. Rope	Diam.	U-Bolt Dimensions Length Overall	Center to Center	Unit Pkg.
12171	1/8"	3/16"	1"	1/2"	6
12172	3/16"	1/4"	1-1/16"	9/16"	6
12173	1/4"	5/16"	1-1/2"	11/16"	6
12175	3/8"	3/8"	2"	7/8"	4
12177	1/2"	7/16"	2-3/8"	1"	4



Bolt Snap

Malleable Iron • Cadmium Plated

Auveco Part No.	Type	Size of Eye	Overall Length	Ring Size Snap Opening	Unit Pkg.
12169	2	5/8"	4"	3/8"	2

Nylon Spacer Bushings (Stand-Offs)



Tough and resilient white nylon spacer bushings are ideal for use in electrical and electronic applications or anywhere a slip surface is needed. They can be used as bushings, bearings, rollers, glides or separators.

Auveco Part No.	I.D.	O.D.	Length	Unit Pkg.
16198	.257"	1/2"	1/4"	100
16200	.257"	1/2"	3/8"	100
16202	.257"	1/2"	1/2"	100
16204	.257"	1/2"	5/8"	100
16205	.257"	1/2"	3/4"	100
16207	.257"	1/2"	1"	100

Standard Insulating Bushings

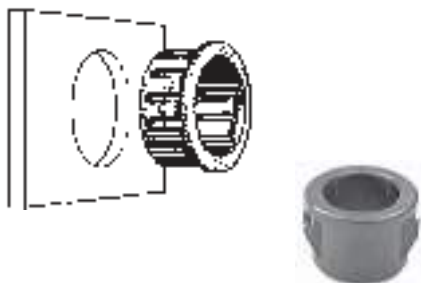

Nylon bushings designed to protect wires, cables, tubing, etc. from sharp, unfinished panel edges. Each size bushing employs multiple lock features to positively snap into panels ranging from 1/32" to 1/8" thickness. Available in both black and white nylon.

Auveco Part No.		Dimensions			Panel Hole Dia.	Unit Pkg.
Black Nylon	White Nylon	Inside Dia.	Head Dia.	Thick-ness		
16087	. . .	1/4"	15/32"	13/32"	3/8"	50
16088	. . .	3/8"	37/64"	13/32"	1/2"	50
16089	. . .	7/16"	21/32"	13/32"	9/16"	50
16090	. . .	1/2"	23/32"	13/32"	5/8"	50
16091	. . .	5/8"	27/32"	13/32"	3/4"	50
16092	. . .	11/16"	61/64"	29/64"	7/8"	50
16093	. . .	3/4"	1-1/8"	29/64"	1"	50
16094	. . .	15/16"	1-7/32"	29/64"	1-3/32"	50
16095	16107	15/16"	1-23/64"	29/64"	1-1/4"	50
16096	16108	1-5/16"	1-39/64"	29/64"	1-1/2"	25
16097	. . .	1-5/8"	2-1/8"	29/64"	2"	25

All-Fit Adjustable Bushings



Black nylon "ALL-FIT" Adjustable Bushings are designed to protect wire, cable, tubing or irregular shaped items from sharp, unfinished edges. The specially designed resilient multiple supports absorb shock and vibration, and adjust to accept various diameters and shapes. The ALL-FIT Bushing is equipped with multiple locks to positively snap in panel thicknesses ranging from 1/32" to 1/8"

Auveco Part No.	Panel Hole Dia.	Bushing Dimensions			Unit Pkg.
		Head Dia.	Thick-ness	Max. I.D.	
16564	5/8"	23/32"	13/32"	7/16"	50
16565	3/4"	55/64"	25/64"	1/2"	50
16567	7/8"	15/16"	29/64"	9/16"	50
16568	1"	1-1/16"	29/64"	3/4"	50



Shaft Collars

Precision machined from cold finished steel. Equipped with cup point socket set screws. Zinc plated finish.



Auveco Part No.	Bore (I.D.)	O.D.	Width	Set Screw Size	Unit Pkg.
15837	1/4"	1/2"	5/16"	#10 x 1/8"	5
15838	3/8"	3/4"	3/8"	1/4" x 3/16"	5



Clear Flexible Vinyl (PVC) Tubing

Our tubing has a broad range of chemical resistance to acids, alkalis and solvents. It's ideal for use in industrial air pressure line applications, in the food industry (FDA approved), for potable water, and for various gases and chemicals.

Auveco Part No.	I.D.	O.D.	Wall Thickness	*Maximum Suggested Working Pressure (PSI @ 70° F)	Unit Package Quantity
14801	1/8"	1/4"	1/16"	59	100 Ft.
14802	3/16"	5/16"	1/16"	51	100 Ft.
14803	1/4"	3/8"	1/16"	51	100 Ft.
14804	5/16"	7/16"	1/16"	48	100 Ft.
14805	3/8"	1/2"	1/16"	41	100 Ft.
14806	3/8"	5/8"	1/8"	55	100 Ft.
14807	1/2"	5/8"	1/16"	28	100 Ft.
14808	1/2"	3/4"	1/8"	41	100 Ft.

*We recommend verification by testing of the size and material to be used.

FAX FORM

For your convenience and our efficiency, Auveco has custom fax order forms available. This order form ensures that your fax includes all the necessary information needed for Auveco to quickly process your order. You can request fax order forms when you place your next product order.

Pushnut Fasteners (Axle Caps)

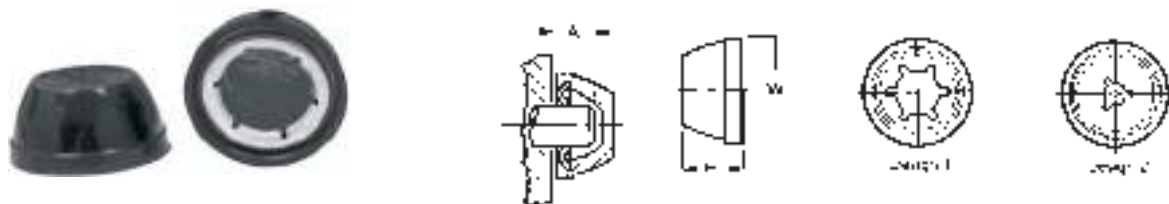

- Cover Color - Black
Cover Material - Plastic
- Caps self-align on shafts
 - Low push-on force, high retention
 - Fast installation

Auveco Part No.	Unit Pkg.	Shaft Dia.	Cap O.D. W	Height Overall H	Min. shaft Extension A	Steel Thickness	Tooth Design	Min. Push-on Force	Min. Holding Strength
14178	50	3/16"	.656	.344	.150	.012	2	35	220
16605	15	3/4"	1.300	.645	.200	.018	1	95	1200

Washer Cap Type Pushnut Fasteners



Finish - Zinc

Auveco Part No.	Unit Pkg.	Dimensions				Stud Diameter (In.)	Performance Pounds	
		Steel Thickness (In.)	Height H (In.)	Cap Dia. (In.)	Washer Dia. D (In.)		Push-On Force	Min. Holding Strength
14170	100	.018	.205	.289	1/2	1/4(.250)	65	280
14171	100	.020	.236	.358	5/8	5/16(.312)	90	460
*8719	100	.020	.234	.419	11/16	3/8(.375)	70	380
14172	100	.025	.270	.431	3/4	3/8(.375)	90	700
14173	100	.030	.328	.504	7/8	7/16(.438)	150	960
8665	100	.030	.328	.567	15/16	1/2(.500)	150	800
14174	50	.031	.413	.693	1-3/16	5/8(.625)	230	1500

*Nickel Plated

Sec. 27

MISCELLANEOUS ITEMS

Push-Pull Controls

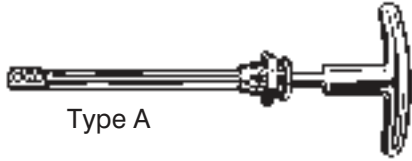

Type A

20242

Type A
6' Long
Chrome T-Handle
Twist To Lock
7/16"-20 Body Thread
Wire Diameter: .072"

UNIT PACKAGE: 1



14541

Type B
Choke Control
5' Long
Black Knob
3/8"-24 Body Thread
Wire Diameter: .047"

UNIT PACKAGE: 1



Type B

20243

Type B
Choke Control
8' Long
Black Knob
3/8"-24 Body Thread
Wire Diameter: .054"

UNIT PACKAGE: 1

Mechanics Wire

Soft Annealed, Black Steel Wire



Auveco Part No.	Wire Gauge	Wire Length	Unit Pkg.
14205	18	2 LB. (332')	1 Spool
14206	16	2 LB. (192')	1 Spool
14207	18	5 LB. (831')	1 Spool
14208	16	5 LB. (480')	1 Spool

Perforated Hanger Strap

Hot Rolled Galvanized Steel



14926

28 Gauge
3/4" Wide x 10 Ft.

UNIT PACKAGE: 1 ROLL

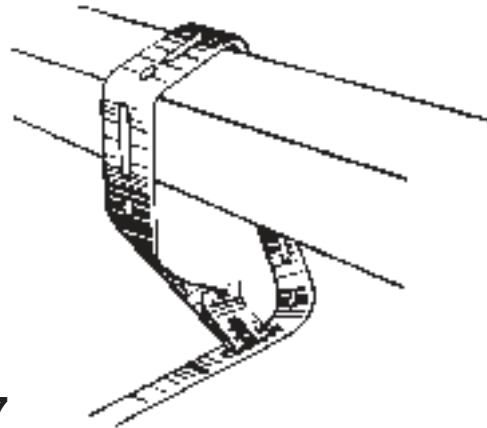

14927

24 Gauge
3/4" Wide x 10 Ft.

UNIT PACKAGE: 1 ROLL

MISCELLANEOUS ITEMS

Gas Pump Nozzles

Rebuildable



16294
For Unleaded
(No Lead) Gas
Blue Scuff Guard
1" Female Thread

UNIT PACKAGE: 1



16296
"Throwaway Nozzle"
For Unleaded
(No Lead) Gas
Blue Scuff Guard
3/4" Female Thread

UNIT PACKAGE: 1



16297
"Throwaway Nozzle"
For Unleaded
Red Scuff Guard
3/4" Female Thread

UNIT PACKAGE: 1

16298
For Diesel Fuel
Black Scuff Guard
1" Female Thread

UNIT PACKAGE: 1



Gas Pump Swivel

C.A.R.B. Approved

Minimum Pressure Drop: Less Than 1PSI @ 10GPM

16299

3/4" Male x 3/4" Female

UNIT PACKAGE: 1



Gas Pump Fail-Safe Breakaway Hose Coupling

C.A.R.B. Approved • 360 Degree Swivel • 1.5 Pound Pressure Drop @ 10GPM

16303

3/4" Diameter

UNIT PACKAGE: 1



Expansion Plugs

Zinc Plated



Auveco Part No.	Size	Type	Unit Pkg.
3937	1/2"	Concave	100
3938	5/8"	Concave	100
3939	3/4"	Concave	100
3941	15/16"	Concave	100
3942	1"	Concave	100
3944	1-1/8"	Concave	100
3945	1-3/16"	Concave	100
3946	1-1/4"	Concave	100
3947	1-3/8"	Concave	100
3949	1-5/8"	Concave	50
3950	1-3/4"	Concave	50
3952	7/16" O.S.	Cup	25
3953	1/2"	Cup	25
3956	5/8"	Cup	25
3957	3/4"	Cup	25
3958	7/8"	Cup	25
15212	15/16"	Cup	50

Auveco Part No.	Size	Type	Unit Pkg.
3960	1"	Cup	25
3961	1-1/8"	Cup	25
3962	1-7/32"	Cup	25
3963	1-1/4"	Cup	25
3964	1-3/8"	Cup	25
3965	1-1/2"	Cup	25
3966	1-5/8"	Cup	25
3967	1-3/4"	Cup	25
3968	1-7/8"	Cup	25
3969	1-15/16"	Cup	25
3971	2"	Cup	25

See Page 74 for Metric Expansion Plugs. For an Assortment of Expansion Plugs, See Kit No. 6067

MISCELLANEOUS ITEMS

Battery Hold Down Bolts

Not Actual Size



14461

(Chry: 2534814)
Plain

Battery Hold Down Bolt w/Nut
Size: 1/4"-20 x 7"
Thread Length: 2"

UNIT PACKAGE: 10

Not Actual Size



8964

(Ford: B5A-10756-B)
Plain

Battery Hold Down Bolt w/Nut
Size 5/16"-18 x 10"
Thread Length 2-3/4"

UNIT PACKAGE: 10

Not Actual Size



8971

(Chry: 2074089)
Plain

Inside Battery Hold Down Bolt w/Nut
Size 1/4"-20 x 9"
Thread Length 2-1/4"

UNIT PACKAGE: 10

Not Actual Size



10643

Zinc

Battery Hold down Bolt w/Nut
Size 5/16"-18 x 12"
Thread Length 6"

UNIT PACKAGE: 10

Not Actual Size



8963

(GM: 3688699)
Plain

Battery Hold Bolt w/Nut
Size: 5/16"-18 x 8"
Thread Length: 1"

UNIT PACKAGE: 10

Not Actual Size



10644

Plain

Battery Hold Down Bolt w/Nut
Size: 3/8"-16 x 10"
Thread Length: 3"

UNIT PACKAGE: 10

WINDSHIELD REVEAL MOULDING TOOLS

Sec. 28

Tools used to remove windshield reveal moulding from retaining clips on GM vehicles with rubberless installations.



20824
Left Hand

UNIT PACKAGE: 1



7731
Right Hand

UNIT PACKAGE: 1



7914

Double Ended Tool

UNIT PACKAGE: 1



13574

Glass Retainer Clip Installer

This tool reduces the risk of chips and scratches to glass windows put in by make shift tools. This tool is specifically designed to fit trim clips over the studs and virtually eliminates glass breakage. It also dispenses with the need to remove rubber-like sealant surrounding the studs.

A practical tool for placing trim retainer clips over headed studs welded around the body window shields and rear window openings.

UNIT PACKAGE: 1



20906

Windshield Locking Strip Tool

This tool is used when replacing the windshield, rear glass or sliding rear glass on vehicles with locking strips. The unique design allows the tip to swivel 90 degrees in either direction to work where other tools can't. Just select the tip with the opening that most closely fits the locking strip and then feed the locking strip into the eyelet. Overall length: 8-1/4"



UNIT PACKAGE: 1



20907

Windshield Wiper Arm Remover

Makes wiper arm removal and replacement an easy job without damaging the vehicle finish. Simply place the "hook" under the arm base, lift and squeeze the wiper arm and tool handle together. The wiper arm lifts right off. Reverse the procedure to install a wiper arm. Overall length: 6-7/8"

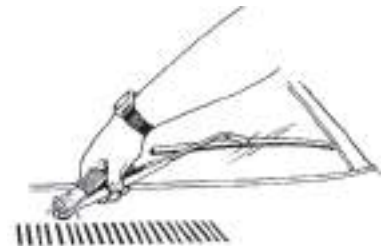

UNIT PACKAGE: 1

TOOLS

(Not Actual Size)



Actual Size 6-1/4"

7778

For removing window crank handle retaining clips. The clip remains in the handle after being "popped off".

UNIT PACKAGE: 1

(Not Actual Size)



7672

Headliner Tool:
Stuffs headlining in channel above doors. Stuffs upholstery, trim edges into tedious places. Blunt edge of blade cannot damage material. Easy to use around curves and near corners.

UNIT PACKAGE: 1

(Not Actual Size)



7999

The Trim Pad Removing Tool is the first tool designed specifically to pull out the plastic trim pad fasteners used on GM cars. It reaches under the trim panel, supports and grips the plastic fastener, and lifts it without damage to the fastener or to the trim pad backboard. The Trim Pad Removing Tool is made of heat treated, high carbon steel and will work equally well on metal fasteners.

UNIT PACKAGE: 1

(Not Actual Size)



13575

For tucking headlining and upholstery around windows and above doors and other hard to reach places.

A sturdy tool with a slightly curved blade that has finished edges and rounded corners. Comfortable wood handle with eyelet hole through one end.

UNIT PACKAGE: 1



15301

Clip Removal Tool

The right tool for removing clips and retainers quickly and easily. Simply seat the tool on the shaft of the fastener and squeeze the handles together. Made of high carbon steel and heat treated for strength. Zinc plated with vinyl molded handle grips.

UNIT PACKAGE: 1

20822

Knife & Scissors Sharpener



Quickly sharpens knives and scissors of all types. Can also be used on hatchets, scrapers and garden tools. The guard protects the hand.

UNIT PACKAGE: 1



13626

A unique retractable scraper that takes the aggravation out of getting old stickers off car windshields and paint blotches off windows. The scraper is 7-7/8" when fully open and locked in position. The razor blade holder tilts the blade to give a better angle of attack in tight corners. The blade can be folded 180 degrees into the handle and locked when not in use, permitting it to be kept in a tool box safely. The blade can be replaced when worn out and the entire tool is compact and durable as well as economical.

UNIT PACKAGE: 1



13625

Single Edge Razor Blades
For Use w/13626 and
General Purpose

UNIT PACKAGE: 100



14543
14575
14576

UNIT PACKAGE: 25
UNIT PACKAGE: 100
UNIT PACKAGE: 1,000

Now you can safely remove stickers from plastic-coated windshields without risk of scratching or cutting the windshield.

Made of polypropylene, these blades are also ideal for scraping many other surfaces in automotive, industrial and home applications. Use with tool 13626



13578

Auto Trimmers & Upholsterers
Combination Knife

Made of finest steel with both hook and pointed blade used for ripping seams. Cuts auto and home carpeting, vinyl, plastic and rubber.

Beechwood handle contoured to fit hand. A handy professional tool.

UNIT PACKAGE: 1



**Mini Plastic
Scraper
With Razor Blade**

17978

Mini Scraper with razor sharp edge that cuts or scrapes paint, stickers, cardboard, string, etc. Flip a latch and turn the razor blade over to safely store the scraper.

UNIT PACKAGE: 5



20823

Extra Long Sticker Scraper

Specially designed to access steep, sloping windshields and other hard-to-reach places. Excellent for corners and on curved surfaces. Supplied with 5 standard steel razor blades and 1 plastic blade. Use the plastic blade on laminated windows and plastic bumpers. Extra blades are stored in the handle. Heavy duty construction. Overall Length: 16"

UNIT PACKAGE: 1



Not Actual Size

13572

All purpose awl used in the installation of roof windows, windshield rubber and back glass. It is used to remove body clips, mouldings and for spring pulling and cotter pin extracting or for radiator hose removal. Great for hard to reach places. Tempered end. 1-1/4" hook. 4-1/2" blade. Overall length is 8-1/2"

UNIT PACKAGE: 1



Not Actual Size

17088

All purpose awl with an extra long hook. Use to remove mouldings, body clips, windshield seals, cotter pins and radiator hoses. Made of tough spring steel, heat treated, tempered and plated. Features 4-7/8" long blade with 2" long hook. Overall length is 8".

UNIT PACKAGE: 1



13579

Heavy Duty Scratch Awl

3-1/2" blade with rugged plastic handle.

UNIT PACKAGE: 1

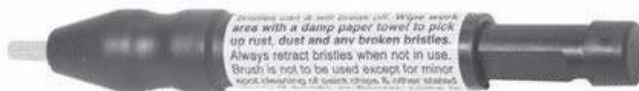

Not Actual Size

Prep Pen (Spot Sanding Pen) With Glass Fibers

18335

Now you can thoroughly clean rust, dirt or wax from any tight corner, crevice or hard to reach spot with 20,000 glass fibers in a pen point. The fibers are finer than human hair yet stronger than steel when it comes to cleaning power.

Sand paper can be too rigid to directly contact and clean the contours of inside edges. Thus conventional sanding only cleans the high spots. The Prep Pen's glass fibers can be extended out (by turning) to ensure even the smallest recesses get cleaned.

UNIT PACKAGE: 1



20903

"O" Ring and Seal Pick

Quickly removes and installs "O" Rings and seals. Tips are angled for hard-to-reach areas typically found around brakes, air conditioning and transmissions.

The tips are hardened to stay sharp. The handle is knurled for a sure grip. Overall Length: 8-3/4"

UNIT PACKAGE: 1

TOOLS



20902

Constant Tension Band (Flat Band)
Hose Clamp Pliers

Removes and installs hose clamps (Auveco part numbers 18127 - 18132) on heater and radiator hoses. Tips screw in and out to fit all sizes of clamps. Ratcheting lock mechanism holds the clamp in an open position for easy removal and installation. Tips can be switched to accommodate different applications. Offset jaws allow access to hard-to-reach areas.

UNIT PACKAGE: 1



7657

Hog Ring Plier
Straight Nose Spring Grip,
holds rings in place for fast work.

UNIT PACKAGE: 1



7658

Hog Ring Plier
Offset Angle Nose for close
to floor non-removable cushions.

UNIT PACKAGE: 1

**Convertible Retaining Ring Pliers
For Internal and External Retaining Rings**

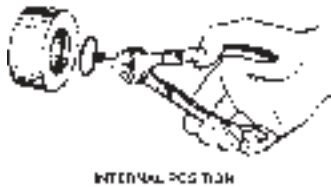

INTERNAL POSITION



7909

7909

Use With Auveco Retaining Rings:

- 8677 To 8678 (External)
- 8688 To 8697 (Internal)
- 8700 To 8709 (External)
- 10116 To 10121 (External)

UNIT PACKAGE: 1



EXTERNAL POSITION



7910

7910

Use With Auveco Retaining Rings

- 8679 To 8683 (External)
- 8698 To 8699 (Internal)
- 8710 To 8712 (External)
- 10122 To 10129 (External)
- 16743 To 16748 (External)

UNIT PACKAGE: 1



20905

Hood Prop



Unique 3-Piece telescoping design allows a mechanic to hold open the hood in any desired position from 18-1/2" to 46-3/4". It can be used either in the front of the vehicle or on the side for better access to the engine compartment. Also great for body or repair work on doors, trunk lids and hatchbacks. Overall length: 18-1/2"

UNIT PACKAGE: 1



12753

Torx® Key Set

Sizes: T9, T10, T15, T20, T25, T27, T30, T40

UNIT PACKAGE: 1



Torx® Power Drive Bits

1" Shank

Auveco Part No.	Bit Size	Hex Size	For Screw Size	Unit Pkg.
12472	T-10	1/4"	No. 4	1
11949	T-15	1/4"	No. 6	1
11950	T-20	1/4"	No.8	1
12103	T-25	1/4"	No. 10	1
14913	T-27	1/4"	No. 12, 1/4"	1
12104	T-30	1/4"	1/4"	1
12105	T-40	1/4"	5/16"	1
14916*	T-55	5/16'	1/2", 9/16", 5/8"	1

*1-1/4" Shank



Torx® Power Drive Bits

2" Shank

Auveco Part No.	Size	For Screw Dia.	Unit Pkg.
12474	T-15	6	1
12475	T-20	8	1
12477	T-30	1/4"	1

Includes One of Each:



Part No. 12526

Torx® Power Drive Bit Set
1" Shank

Auveco Part No.	Size
12472	T-10
11949	T-15
11950	T-20
12103	T-25
12104	T-30
12105	T-40

Fold-Up Hex Key Set

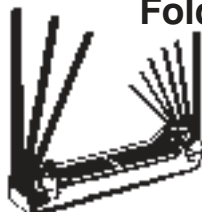

Auveco Part No.	Size	Keys	System
7976	Small .050" thru 5/32"	8	U.S.
7977	Medium 5/64" thru 1/4"	9	U.S.
7978	Large Extra Long 3/16" thru 3/8"	5	U.S.

UNIT PACKAGE: 1



Hexagon Shank Magnetic Chuck
for Driving Screws Into Metal
with an Electric Drill.

Auveco Part No.	Hex Head Shank	Screw Size	Unit Pkg.
7767	1/4"	1/4"	1
11761	1/4"	5/16"	1
11762	1/4"	3/8"	1



Hex Keys

Auveco Part No.	Socket Screw Size	Wrench Size	Unit Pkg.
5414	1/16"	1/32"	10
5415	No. 8	7/64"	10
5417	1/4"	1/8"	10

Metric Hex Key
Plain Finish



Use With DIN 912 & DIN 7991

Auveco Part No.	Hex Size	For Screw Size	Unit Pkg
7965	3mm	4mm	10

Torx® Tool Selection Chart

Auveco Part No.	Size	Round Washer Head Screw Size	Pan Head Screw Size	Pan Head Struck Slot Screw Size	Flat Head Screw Size	100 Flat Head Screw Size	Hex Head Screw Size	Hex Washer Head Screw Size	Truss Head Screw Size	Fillister Head Screw Size	Oval Head Screw Size
12472	T-10	4 & 5	4 & 5	4 & 5	5 & 6	6	4 & 5	5	6	4 & 5	5
11949	T-15	6	6	6	8	8	6	6	8	6	6
11950	T-20	8	8	8	10	10	8	8	10	8	8
12103	T-25	10	10	10	12	x	10	10	12	10	10
14913	T-27	12	12	12	1/4	x	12	12	1/4	12	12
12104	T-30	1/4	1/4	1/4		1/4	1/4	1/4		1/4	1/4
12105	T-40		5/16	5/16	5/16&3/8	5/16	5/16	5/16	5/16	5/16	5/16
•••••	T-45		3/8	3/8		3/8	3/8	3/8	3/8&7/16	3/8	3/8
•••••	T-50		7/16	7/16	7/16&1/2	7/16			1/2	7/16	7/16&1/2
14916	T-55		1/2	1/2	9/16&5/8	1/2			9/16&5/8	1/2&9/16	9/16&5/8
•••••	T-60				3/4				3/4	5/8	3/4

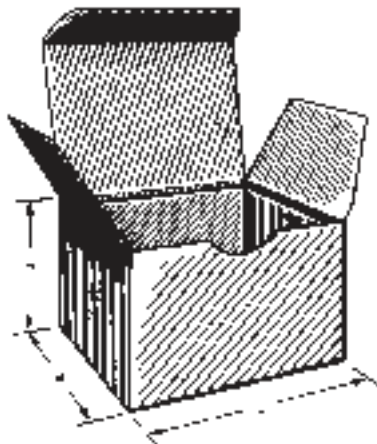

Plain White Boxes
No Imprinting

White-recycled chipboard versions of six popular sizes of Auveco boxes for packaging small parts. Each box is made of .028" thick chipboard. The full-flap, hardware bottom with locking side tabs provides for a full-strength, spill-proof box. Refer to the chart below for the quantity of boxes per unit package carton.

Auveco Part No.	Length (L)	Width (W)	Height	Boxes Per Carton	Weight Per Carton (lbs.)
0-Boxes	2-3/4"	1-1/2"	1-3/4"	1050	30
1-Boxes	2-3/4"	2-1/4"	1-7/8"	800	33
2-Boxes	3-3/8"	2-7/8"	2"	375	23
3-Boxes	3-1/2"	2-7/8"	2-7/8"	250	19
4-Boxes	4-3/4"	2-3/4"	3"	250	21
7-SBoxes	4-1/4"	3"	6-1/2"	425	55

UNIT PACKAGE: 1 CARTON

Professional Drill-Out Broken Bolt Extractor Kit

Take The Frustration Out Of Removing Broken Bolts.

Made In U.S.A.



- Revolutionary new method for removing broken bolts
- Incredible improvement over traditional methods of extracting broken bolts
- Easy, timesaving operation
- Fast and reusable
- Self-centering tip

Part No. 17093

For grade 5 and grade 8 bolts in sizes: 1/4" (6mm), 5/16" (8mm), 3/8" (10mm) & 1/2" (12mm)

UNIT PACKAGE: 1

Replacement Extractor Tools



Auveco Part No.	Drill Size
20537	1/4" (6mm)
20538	5/16" (8mm)
20539	3/8" (10mm)
20540	1/2" (12mm)

The Drill-Out Broken Bolt Extractor is excellent for removing broken bolts and studs without damaging the threads in the hole. The drill body is manufactured using the finest quality hi-speed steel. The collet is produced from hot die steel, using the finest steel of its type. All Drill-Out Broken Bolt Extractors are made with a precision ground 118° left hand cutting self-centering point, and are heat treated for toughness.

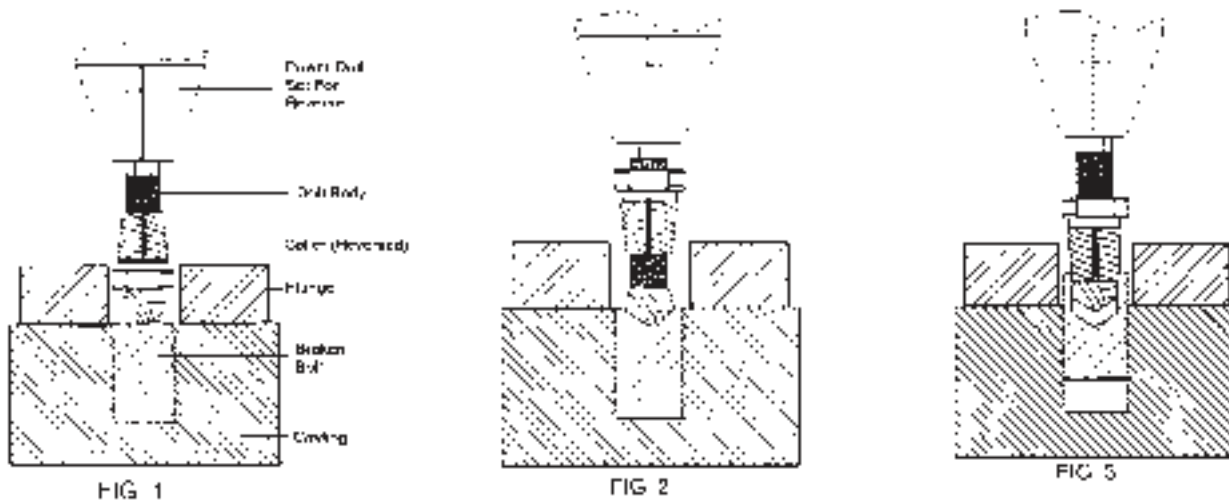

Fast & Easy To Use.

Always Use Protective Eye Wear When Drilling.

1. Place the Drill-Out tool into an electric drill and set for reverse operation. Move the collet up to the chuck. Note: when the bolt is broken below a flange attached to a casting, reverse the collet as in (Fig. 1.)
2. Making sure the drill is set in reverse, place the tip of the Drill-Out on the center of the broken bolt and begin drilling. Do not allow the collet to move down towards the tip while drilling. If so, thread the collet back towards the chuck. Drill just deep enough to start a hole (approximately 1/16").
3. Make sure the hole is started on center of the bolt. If you reversed the collet in step 1, change it back at this time. Continue drilling. Stop just before you reach the front of the collet. Do not let the collet touch the end of the bolt. (Fig.2)
4. Remove the Drill-Out tool from the broken bolt. Move the collet down towards the tip so that 2 threads are showing. Bring drill up to speed and plunge it into the hole. The collet automatically engages and extracts the broken bolt. (Fig.3)

Detailed Instructions Included in The Kit



15748
Moulding Cutting Tool

A professional quality tool that cuts with absolute accuracy every time to give a clean, accurate and precise edge. The **15748** tool features a replaceable razor-sharp blade cutting against a plastic anvil which is also replaceable. Excellent for cutting rubber/plastic moulding (up to 3-1/2"), weatherstrip, carpeting and most flexible materials. The tool measures 10" overall and the handles are vinyl coated.

UNIT PACKAGE: 1



20900
Hose Cutter

Razor sharp blade cleanly cuts heater hoses, fuel line hoses and any other type of flexible hose up to 1-1/4" diameter: The stainless steel blade is reversible for double the life. The pliers are made of glass-filled gray nylon for strength. Includes a locking hoop for safe storage. Overall length: 9-1/2".

UNIT PACKAGE: 1

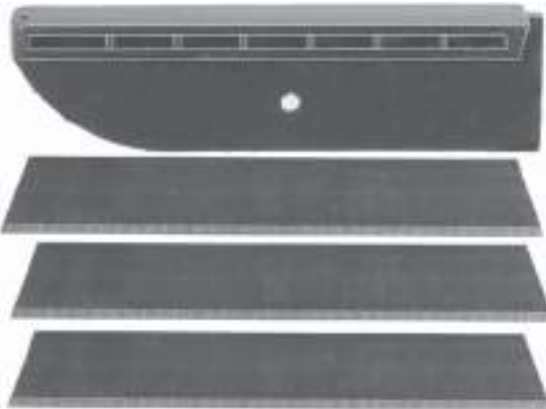

21511
Three replacement cutting blades and one anvil for Moulding Cutting Tool 15748

UNIT PACKAGE: 1 KIT

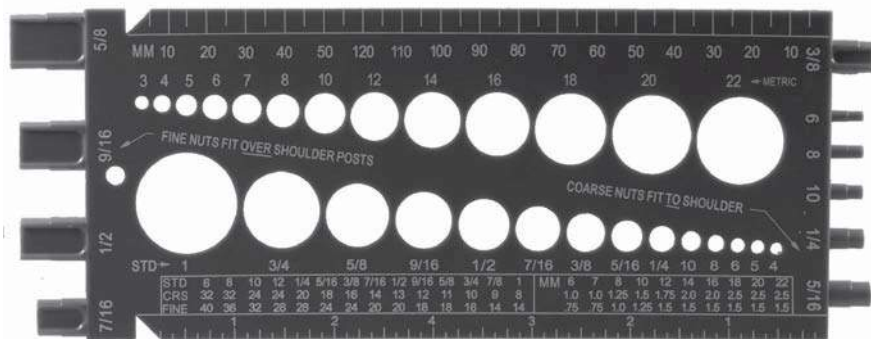

21152

U.S.S., S.A.E. & Metric Bolt and Nut Gauge

Excellent for sizing bolts, screws, nuts (U.S.S., S.A.E. & Metric) and twist drills. You size bolt diameter by pushing bolt through the sizing holes. Also gauges hex nuts and washers (U.S.S. & S.A.E.) while metric hex nuts and washers can be measured by holding them under the metric holes.

The back of the gauge includes a feature for measuring U.S. and Metric thread pitch. Special notches on the front of the tool allow you to measure flat head metal and wood screws.

Made of sturdy, light weight green plastic that resists water, alcohol, oil and grease.

UNIT PACKAGE: 1

TOOLS
Gauges

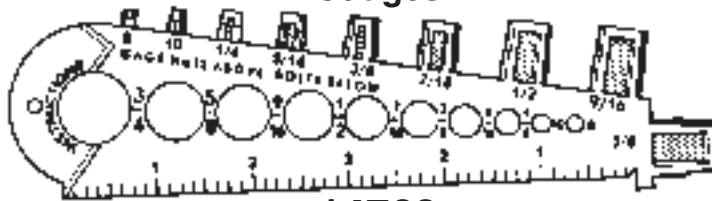

14769

U.S.S. & S.A.E. Plastic Gauge

Just push the bolts through the holes to find the bolt diameter. The length gauge measures "regular" heads from the left end and countersunk heads from the notch at the right end. Nuts drop on the plugs along the top edge of the gauge. S.A.E. fine thread nuts fit to the base of the plugs, U.S.S. coarse thread nuts fit half-way.

UNIT PACKAGE: 1

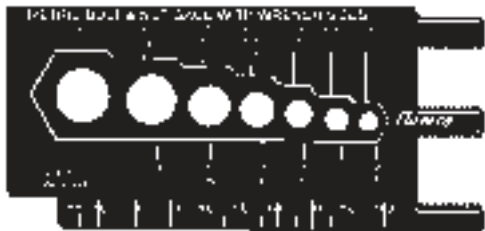

14770

Metric Bolt & Nut Plastic Gauge

Determine the diameter of bolts by pushing them thru the holes. Measure the hex head of bolts & screws or the "across the flat" dimension of hex nuts in the recesses around the holes (listed as wrench size). Right-hand side of tool measures thread pitch (1.00, 1.50, 1.75 & 2.00).

UNIT PACKAGE: 1



14771

Screw Chek'r
Plastic Gauge

Identifies all machine screws, U.S.S. & S.A.E. bolts, wood screws, self-tapping screws, standard size rivets and common cotter pins up to 5/16" diameter. Also includes clearance drill size, tap drill size and tap series information. Instructions included.

UNIT PACKAGE: 1



**Metric Screw Checker
Metal Gauges**
Tells

- Length in millimeters & inches
- Tap series
- I.S.O. preference rating
- Diameter (in millimeters)
- Pitch (in millimeters)
- Clearance drill size
- Tap Drill Size
- Basic diameter (in inches)

12143

For ISO Metric Screws
From 8mm thru 14mm

UNIT PACKAGE: 1



7955

Metric Screw Pitch Metal Gauge:
Pitch Capacity 0.25 to 6mm
24 Blades

UNIT PACKAGE: 1

Aluminum Oxide Resin Bonded Cut-Off Wheels

Sec. 28



Designed for steel cutting use only. Never use these wheels for any other applications.
Never Use On Fiberglass!



Auveco Part No		SPECIFICATIONS				
Unit Pkg. 10	Unit Pkg. 25	Dia.	Thickness	Arbor	Grit	RPM
19688	19687	3"	1/16"	3/8"	54	25,000
19690	19689	3"	1/32"	3/8"	54	25,000
19692	19691	3"	1/16"	1/4"	54	25,000
19694	19693	3"	1/32"	1/4"	54	25,000
19696	19695	3"	1/8"	1/4"	46	25,000
19698	19697	3"	1/8"	3/8"	46	25,000
19702	19701	4"	1/32"	3/8"	60	21,000
19706	19705	4"	1/16"	3/8"	54	21,000
19708	19707	4"	1/8"	3/8"	46	15,300



General Purpose Depressed Center Wheels

TYPE 27 Standard Shape

The most popular Raised Hub wheel for grinding and blending

CAUTION!

Never Use A Wheel That Has Been Dropped

- Always Wear Full Face Protection When Grinding
- Use A Guard Covering 50% Or More Of Wheel Diameter



Auveco Part No		SPECIFICATIONS				
Unit Pkg. 10	Unit Pkg. 25	Dia.	Width	Arbor	Grit	RPM
19712	19711	4"	1/4"	5/8"	36	13,700
19714	19713	4-1/2"	1/4"	7/8"	24	11,900

Cut-Off Wheel Mandrels (Arbors For Air Grinders)



19715
Zinc

Mandrel With
3/8" Shoulder Screw

UNIT PACKAGE: 1

Not Actual Size



19716
Zinc

Mandrel With
1/4" & 3/8" Shoulder Screws

UNIT PACKAGE: 1

Welding Blanket



21083

A 6 ft. x 6 ft. lightweight, welding blanket to protect from the spray of sparks, spatter and slag. Our fire and heat resistant welding blankets are made with a carbon fiber fabric that was developed from NASA technologies. The carbon fibers can withstand temperatures of 1800°F from contact with hot metal, for short durations but should not be exposed to temperatures of 200° F for extended periods. The blankets are easy to clean; just shake, vacuum or use compressed air to blow metal particles out.

UNIT PACKAGE: 1

Heavy Duty Industrial Flashlights



Type 1



Type 2



Type 3

Heavy duty construction for a long life in a tough industrial environment. Water, shock and corrosion resistant. Each flashlight requires two D cell batteries (not included).

16166

Type 1
Parabolic reflector for spot light work with penetrating focused beam. Yellow with black ends. Includes a spare bulb. 8-1/2" Long.

16168

Type 3
Fixed magnet plus Magna-Beam reflector which covers 10 times the normal area. Yellow with black ends. Includes a spare bulb. 8-1/2" Long.

16169

Type 2
Contains super-bright krypton bulb. Burns 70% brighter than ordinary bulb. Magna-Beam flood reflector covers 10 times the normal area. Yellow with blue ends 8-1/2" Long.

UNIT PACKAGE: 1

UNIT PACKAGE: 1

UNIT PACKAGE: 1

"Stubby" Fluorescent Work Light



18245

With a 2" diameter and 9-3/4" length the "Stubby" is a compact, bright work light that provides 13 watts of high intensity light. The 13 watt light bulb is equivalent in light output to a 100 watt incandescent bulb while being four times more efficient and lasting up to ten times longer (10,000 hours).

Protected on-off switch can be operated by depressing domed end of the light. Oil resistant type SJTOW-A 25 foot cord set is specially designed to stay flexible in cold weather.

UNIT PACKAGE: 1

18246

Rough service replacement fluorescent light bulb for 18245 "Stubby" work light. 13 watt, 110 volts.

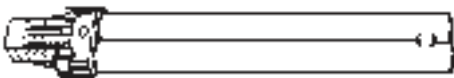

UNIT PACKAGE: 1

Wire Bending Tool
For Truck Seat Springs



16894

A tough tool that makes difficult wire repairs easy. You can bend the ends of no sags, edgewise and foam springs right on the spot, making offsets where you need them. Can be readily mounted in a vise for duplicating complex repetitive wire bends. Constructed of heat-hardened steel for long life.

UNIT PACKAGE: 1



16029

Pinpoint Tip Tweezers
Now you can remove bugs, hair, lint or any other airborne debris from newly painted surfaces, with pinpoint accuracy and without disturbing the finish.

The stainless steel tweezers are non-corrosive, non-magnetic and they won't tarnish. The handy pen design slips into a painter's pocket until needed. Overall length: 5-3/16".

UNIT PACKAGE: 1

16275

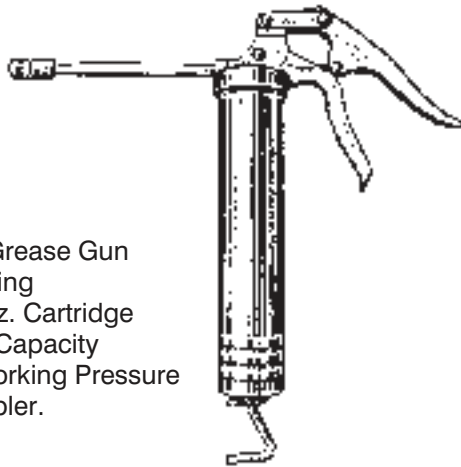

One-Hand Grease Gun
3-Way Loading
Uses 14.5 oz. Cartridge
16 oz. Bulk Capacity
2500 PSI Working Pressure
3 Claw Coupler.
Blue

UNIT PACKAGE: 1

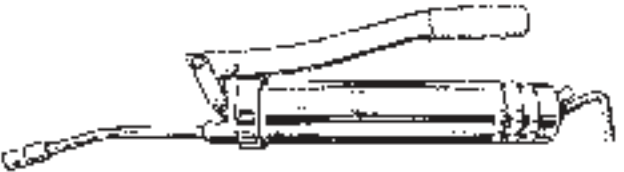

16276

Heavy Duty Grease Gun
3-Way Loading
Uses 14.5 oz. Cartridge
16 oz. Bulk Capacity
10,000 PSI Working Pressure
3 Claw Coupler
Blue With Orange Vinyl Grip

UNIT PACKAGE: 1

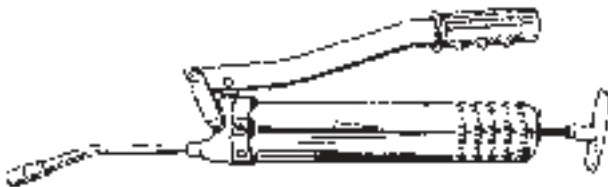

16277

Professional Grease Gun
Delivers Grease At Various
Lever Openings.
3-Way Loading
Uses 14.5 oz. Cartridge
16 oz. Bulk Capacity
Variable Pressure
4 Claw Coupler
Zinc With Black Rubber Grip

UNIT PACKAGE: 1



Not Actual Size

Grease Gun Hoses
1/8" NPT Male Fittings

Part No.	Length	PSI	Unit Pkg.
15691	12"	3000 PSI	1
15692	18"	3000 PSI	1
16279	12"	5800 PSI	1
16280	18"	5800 PSI	1

TOOLS

Caulking Guns

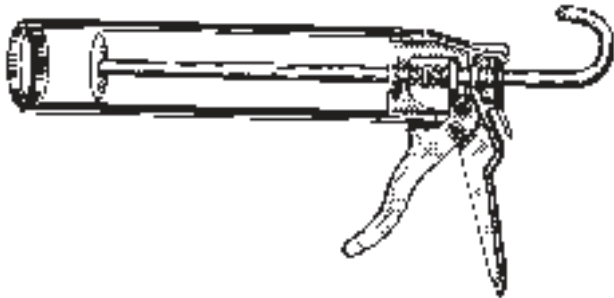

Part No. 16667

UNIT PACKAGE: 1

This professional gun is fabricated from die cast alloy and steel, both riveted and welded for maximum strength. It features a smooth hexagonal drive rod and precision catch plate for effortless action. The handle and trigger are designed for comfortable operation over a long period of use. Corrosion resistant orange epoxy powder coated.



19092

UNIT PACKAGE: 1

This economical gun is fabricated from die cast alloy and steel, both riveted and welded for maximum strength. It features a smooth round drive rod and precision catch plate for effortless action. The handle and trigger are designed for comfortable operation over a long period of use. Corrosion resistant orange epoxy powder coated.

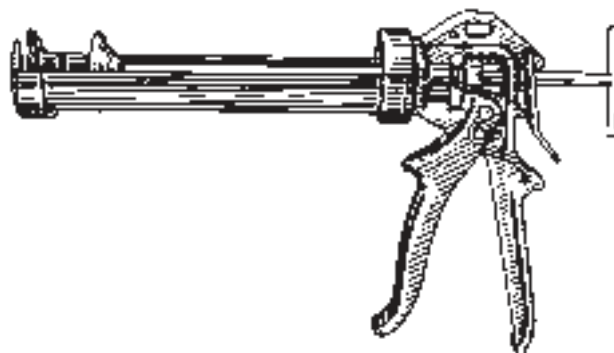

Part No. 17123

UNIT PACKAGE: 1

This deluxe heavy duty caulking gun ensures operator comfort and efficiency of use. It has a die-cast alloy, profiled hand grip for strength and lightness, which is contoured for use by all hand sizes and allows the use of smooth, full strokes. The advanced design of the drive mechanism has a patented catch plate system. Combined with use of a hardened steel drive rod, this prevents notching and scoring of the rod.



13577

Revolving Punch

A fine quality pressed frame revolving punch with drive tubes. All tubes are heat treated to give long wear. Fully nickel plated.

Furnished with tube sizes 0,1,2, 3, 5, and 7 (Hole sizes 5/64", 3/32", 7/64", 1/8", 5/32", and 3/16"). Length 8"

UNIT PACKAGE: 1

TOOLS

Barrel Pump & Suction Gun



16283

Barrel Pump
Designed to handle fluids from drums up to 55 gallons. Delivers 1-1/2" pints per 36" stroke. 2" bung nut. Can Be used for lubricants, chemicals and automotive additives (except transmission oil). Steel construction with sturdy curved polyethylene spout resistant to oil, acid and gasoline.

UNIT PACKAGE: 1



16285

Barrel Pump Hose
40" polyethylene discharge hose with curved spout and connector to fit Auveco barrel pump 16283.

UNIT PACKAGE: 1



16293

Suction Gun
Designed for all purpose draining and filling clutches, differentials and transmissions. Use with any type of non-corrosive lubricants. Needs no priming. One pint capacity. Comes with 11" flexible vinyl hose.

UNIT PACKAGE: 1

Oil Cans



16286

6 oz. Capacity
4" Rigid Spout
Brass Pump, Steel Body

UNIT PACKAGE: 1

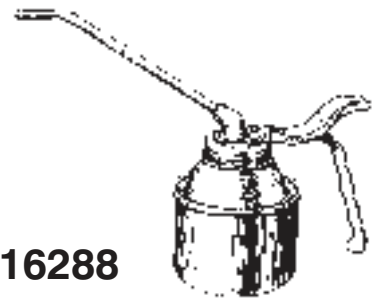

16288

12 oz. Capacity
5" Rigid Spout
Brass Pump, Steel Body

UNIT PACKAGE: 1



16289

6 oz. Capacity
7" Flexible Spout
Brass Pump, Steel Body

UNIT PACKAGE: 1

New



Flat Head Torx® Drive Floor Screws
 Type "F" Thread Cutting Point
 Phosphate & Oil

Auveco Part No.	Size	Drive Size	Unit Pkg.	Auveco Part No.	Size	Drive Size	Unit Pkg.
21717	1/4"-20 x 2"	T-30	50	21724	5/16"-18 x 2"	T-40	25
21718	1/4"-20 x 2-1/2"	T-30	50	21725	5/16"-18 x 2-1/4"	T-40	25
21719	1/4"-20 x 3"	T-30	25	21726	5/16"-18 x 2-1/2"	T-40	25
21720	1/4"-20 x 3-1/2"	T-30	25	21727	5/16"-18 x 3"	T-40	15
21721	1/4"-20 x 4"	T-30	15	21728	5/16"-18 x 3-1/2"	T-40	15
21722	1/4"-20 x 5"	T-30	15	21729	5/16"-18 x 4"	T-40	10
21723	1/4"-20 x 6"	T-30	15	21730	5/16"-18 x 5"	T-40	10

TAPPING SCREWS



**Phillips Square Combo Drive Tek®
 Liner Screws With Locking
 Wedges Under Head Zinc & Yellow**

Auveco Part No.	Size	Head Dia.	Unit Pkg.
21731	#10 x 3/4"	5/8"	50
21732	#10 x 1"	5/8"	50
21733	#10 x 1-1/4"	5/8"	50



**Torx® Wafer Head
 Tek® Liner Screws
 Zinc**

Auveco Part No.	Size	Head Dia.	Drive Size	Unit Pkg.
21734	#10 x 3/4"	15/32"	T-25	50
21735	#10 x 1"	15/32"	T-25	50
21736	#10 x 1-1/4"	15/32"	T-25	50
21737	#10 x 1-1/2"	15/32"	T-25	50



21840
 (Toyota: 90105-06037)
 Black E-Coat
 M6-1.0 x 11mm
 Hex Head Flange
 10mm Hex
 15.5mm Flange O.D.
 Luggage Compartment
 Door & Lock and
 Radiator Grille
 Toyota & Lexus
 2001 - On
 UNIT PACKAGE: 25



22104
 (Ford: N801169-S900)
 Black Zinc
 Hex Head Sems® Tapping
 Screw
 M4.2-1.41 x 22mm
 Hex Size: 5.5mm
 Washer Diameter: 16mm
 Front Bumper
 Exterior Trim & Front Fender
 Ford & Lincoln 2010 - 1997
 UNIT PACKAGE: 50



22070
 (GM: 11570637)
 Black Zinc
 Torx® Pan Head Sems®
 Tapping Screw With Dog
 Point M4.2-1.41 x 20mm
 (#8 x 25/32")
 17mm (11/16") Washer
 O.D. T15 Drive
 GM 2007 - On
 UNIT PACKAGE: 50



22081
 (GM: 11609762)
 Black Zinc
 Pozi-Drive Round Washer
 Head Sems® Tapping
 Screw
 M4.2-1.41 x 25mm
 Washer Diameter: 17mm
 Chevrolet Equinox, GMC
 Acadia & Terrain and
 Saturn Outlook 2007 - On
 UNIT PACKAGE: 50

New

TAPPING SCREWS CONTINUED



22030

(BMW: 07-14-7-129-160)
Black Zinc M4.8-1.61 x 16mm
(#10 x 5/8")
Hex Head Sems® 18mm Washer O. D.
8mm Hex BMW
2013 - 1999

UNIT PACKAGE: 50



21774

(Mercedes-Benz: 201-990-05-36)
Black E-Coat
M4.8-1.61 x 20mm
(#10 x 25/32")
Hex Head Sems®
26mm Washer O.D.
8mm Hex
Front Bumper & Moulding Strip
Mercedes-Benz
2014 - 1993

UNIT PACKAGE: 25



21865

(Chrysler: 6509539-AA)
Phosphate
Hex Head Sems®
Tapping Screw
M4.8-1.61 x 32mm
(#10 x 1-1/4")
19mm (3/4") Washer O.D.
8mm Hex
Chrysler Town & Country
and Dodge Ram
2014 - 09

UNIT PACKAGE: 50



22110

(VW: N90775801
BMW: 07146963883)
Black Zinc

Torx® Truss Head
Tapping Screw
M4.8-1.61 x 18mm
Head Diameter: 15mm
T25 Drive
Audi & VW 1998 - On
BMW 5, 6 & 7 Series
2011 - 00

UNIT PACKAGE: 25



21746

(Mitsubishi: MF453091)
Black Oxide

M5-1.59 x 11mm
Phillips Truss Head
11mm Head O.D.
Interior Trim
Mitsubishi Galant
2008 - 2004

UNIT PACKAGE: 50



21747

Black Oxide

M5 - 1.59 x 11mm
Phillips Round Washer Head
12mm Washer Head O.D.
Chrysler & Imports

UNIT PACKAGE: 50



22111

(VW: N90892001,
N90775001)
Black Zinc

Torx® Truss Head
Tapping Screw
M5-2.12 x 19mm
Head Diameter: 14mm
T25 Drive
Audi, Porsche & VW
2014 - 07

UNIT PACKAGE: 25



21841

(Toyota: 75392-42030)
Black E-Coat

M5.2-2.0 x 20mm
(#12 x 25/32")
Phillips Hex Head Sems®
12mm (1/2") Washer O.D.
8mm Hex
Front Bumper Moulding
Toyota & Lexus
2010 - On

UNIT PACKAGE: 25



21839

(Toyota: 90159-A0001;
90159-50316)
Zinc

Phillips Hex Head Sems®
M5.2-2.0 x 21mm
(#12 x 13/16")
14mm (9/16") Washer O.D.
10mm Hex
Front Bumper, Bumper Stay
& Radiator Grille
Toyota & Lexus
2000 - On

UNIT PACKAGE: 25



21744

(Mitsubishi: MS452348)
Black E-Coat

M6-1.81 x 20mm
Phillips Hex Head Sems®
13mm (1/2") Washer O.D.
10mm Hex
Bumper, Exterior Trim,
Fender Shield and
Quarter Panel
Mitsubishi Diamante,
Eclipse, Galant, Lancer,
Mirage, Montero
& 3000GT
2012 - 1991

UNIT PACKAGE: 25



22106

(Toyota: 90159-60303)
Zinc

Phillips Hex Head Sems®
Tapping Screw
M6.3-2.5 x 18mm
14mm Washer O.D.
10mm Hex Toyota & Scion
1993 - On

UNIT PACKAGE: 25



21838

(Toyota: 90159-60488)
Zinc

M6.3-2.5 x 24mm
(#14 x 15/16")
Phillips Hex Head Sems®
16mm (5/8") Washer O.D.
10mm Hex
Front Bumper, Bumper Stay,
Hood and Front Fender
Lexus CT200, ES350,
HS250, IS & SC430,
Scion and Toyota
1995 - On

UNIT PACKAGE: 25



21837

(Toyota: 90159-60525)
Black E-Coat

M6.5-2.5 x 19mm
(#14 x 3/4")
Phillips Hex Head Sems®
20mm (25/32") Washer O.D.
10mm Hex
Floor Pan & Lower Back
Panel
Moulding, Rear Bumper
Stay, Suspension Cross
Member and Under Cover
Toyota 1998 - On

UNIT PACKAGE: 25

New



22045
Zinc

Metric Spin Lock
Nut With Serrations
Thread Size: M10-1.50
Flange O.D.: 20mm
Hex Size: 15mm

UNIT PACKAGE: 25



22114

(BMW: 07129904150)
Zinc Finish

"U" Type Nut
M4.8 (#10) Screw Size
Panel Range: 2.3mm - 3.5mm
(.090"-.138")
Center Of Hole To Edge: 8.5mm
BMW 2011 - 1992

UNIT PACKAGE: 25



22074

(GM: 11515638)
Zinc Organic

Metric Extruded "U" Nut
M4.2-1.41 (#8) Screw Size
Locking Thread
Panel Range: .65mm-3.80mm
(.025"-.150")
Center Of Hole To Edge: 15mm
GM

UNIT PACKAGE: 25



22113

(BMW: 51127070202;
VW: N90168602)
Zinc Finish

Metric Extruded "U" Nut
M5-.8 Screw Size
Panel Range: .45mm - 1.5mm
Center Of Hole To Edge: 11.5mm
BMW 1999 - 1992
VW 1993 - On

UNIT PACKAGE: 25



22105

(Honda: 90675-SA5-003)
Zinc

Metric Extruded "U" Nut
M6-1.0 Screw Size
Panel Range: 2mm - 4mm
Center Of Hole To Edge:
14.5mm (9/16")
Acura 2007 - 1998
Honda 2014 - 1983

UNIT PACKAGE: 25



Micro Fuses

•2 Blade

Auveco Part No.	Amp Rating	Color	O.E.M. No.	Unit Pkg.
21828	5	Tan	GM: 19209790	5
21829	7.5	Brown	GM: 19209791	5
21830	10	Red	GM: 19209792	5
21831	15	Blue	GM: 19209793	5
21832	20	Yellow	GM: 19209794	5
21833	25	Natural	GM: 19209795	5
21834	30	Green	GM: 19209796	5



Micro Fuses

•3 Blade

Auveco Part No.	Amp Rating	Color	O.E.M. No.	Unit Pkg.
21749	5	Tan	Ford: DG9Z-14526-N	2
21750	7.5	Brown	Ford: DG9Z-14526-S	2
21751	10	Red	Ford: DG9Z-14526-P	2
21752	15	Blue	Ford: DG9Z-14526-R	2

Mega® Fuses



Auveco Part No.	Amp Rating	Unit Pkg.
21598	40	2
21599	60	2
21600	80	2
18986	100	2
18987	125	2
18988	150	2
18989	175	2
18990	200	2
18991	225	2
22118	250	2
22119	300	2
22120	500	2

New

GASKETS & DRAIN PLUGS

22134

(Toyota: 90430-12031, 90430-12018,
90430-12027 & 90430-C0005)



Oil & Transmission
Drain Plug Gasket
I.D.: 12mm
O.D.: 21mm
Thickness: 1.75mm
Fibre & Aluminum

Toyota 4Runner, Avalon, Camry, Celica, Corolla, Echo,
FJ Cruiser, Highlander, Land Cruiser, Matrix, MR2, Pasea,
Previa, Prius, RAV4, Sequoia, Sienna, Solara, Supra, T100,
Tacoma, Tercel, Tundra, Venza & Yaris 1991 – On

UNIT PACKAGE: 5



22143

(VW: 06L-103-801)

Plastic Oil Drain Plug
Head Diameter: 23mm
(with Screw Driver Slot)
Overall Height: 20mm
With Installed Rubber O-Ring
Black Plastic

Audi A3 & S3 and Volkswagen Golf &
GTI 2015 – On

UNIT PACKAGE: 1

21798

(VW: N91167901)
Zinc



Oil Drain Plug
With Gasket
Thread: M14-1.5
T-50 Torx® Drive
Length Under Head: 12mm
Head O.D.: 19mm

Fits the following M14-1.5 applications:

Audi: A3, A4 Quatro, A5 Quatro, A6, A6 Quatro,
All Road Quatro & Q5

VW: Beetle Turbo, CC Lux, Eos Executive, Eos Komfort, Eos
Sport, GTI, Jetta GLI, Tiguan S, Tiguan SE & Tiguan SEL
2007 – On

UNIT PACKAGE: 2

Additional Application Info



21326

(Subaru: 807016160,803916010;

Toyota: SU003-02194)

Zinc

Oil Drain Plug
Thread: M16-1.5 x 9mm
Hex: 14mm
Washer Head O.D.: 24mm

Fits the following applications:

Scion FR-S 2.0L 2013

Subaru Legacy & Outback 2.5L

UNIT PACKAGE: 2

SPECIALTY RIVETS

21864

(Ford: W713819-S900)

Specialty Rivet
5/32" (4mm) Diameter
Grip: 3/64" – 1/8" (1.2mm - 3.2mm)
Flange Diameter: 3/8" (9mm)
Aluminum Rivet (Black)
With Plastic Cap
Steel Mandrel
Cab & Exterior Trim
Ford F-150
2014 – 2009

UNIT PACKAGE: 25

21714

(Lexus: 90269-04060)

Specialty Rivet
5/32" (4mm) Diameter
Grip: 3/64" – 9/32" (1mm – 7mm)
Flange Diameter: 15/64" (6mm)
Steel Rivet
Steel Mandrel
Lexus GS 300, GS 350, GS 430,
GS 450h & GS 460
2006 – On

UNIT PACKAGE: 25

22089

(GM: 92139150)

Front Bumper & Grille Specialty Rivet
5/32" (4mm) Diameter
Grip Range: 11/64" - 11/32"
(4.4mm - 8.5mm)
Flange Diameter: 9/32" (7.1mm)
Aluminum Rivet
Stainless Steel Mandrel Chevrolet
Camaro 2012 - On

UNIT PACKAGE: 25

22088

(GM: 9132667)

Front & Rear Bumper Specialty Rivet
5/32" (4mm) Diameter
Grip Range: 9/64" - 3/8" (3.6mm – 9.5mm)
Flange Diameter: 7/16" (11.1mm)
Aluminum Rivet

Stainless Steel Mandrel

Buick Regal & Verano; Chevrolet Avalanche, Camaro, Cruze,
Malibu, Sonic & Volt 2010 – On

UNIT PACKAGE: 25

21742

(Toyota: 90269-06054)

Specialty Rivet
5/32" (4mm) Diameter
Grip: 3/64" – 3/8" (1mm – 9.5mm)
Flange Diameter: 15/32" (12mm)
Aluminum Rivet (Black)
Steel Mandrel (Black)

European Toyota and Universal

UNIT PACKAGE: 25

SPECIALTY RIVETS CONTINUED

New



21715

(Toyota: 90269-04047)

Specialty Rivet
5/32" (4mm) Diameter
Grip: 3/64" – 15/32" (1mm - 12mm)
Aluminum Rivet (Black Flange)
Steel Mandrel (Black)
Toyota RAV4 & 4Runner
1996 – On

UNIT PACKAGE: 25



21713

(Toyota: 90269-05034,
90269-05056)

Specialty Rivet
3/16" (5mm) Diameter
Grip: 3/64" – 15/32" (1mm – 12mm)
Flange Diameter: 1/2" (13mm)
Aluminum Rivet With Plastic Cap
Steel Mandrel
Lexus IS 300 and Toyota Celica,
Corolla, Matrix, Prius, RAV4,
Tercel & Yaris
2000 – On

UNIT PACKAGE: 25



21799

Split-Type Rivet
3/16" Diameter
Grip Range: 7/64" – 3/8"
Flange Diameter: 5/8"
Aluminum Rivet & Mandrel
General Purpose

UNIT PACKAGE: 15



22023

(Ford: W702512-S900C)

Fender, Sill & Radiator Support
Specialty Rivet
1/4" (6.3mm) Diameter
Grip: .110" - .189" (2.79mm – 4.8mm)
Flange Diameter: 1/2" (13mm)
Steel Rivet
Steel Mandrel
Ford F-150 Trucks
With Aluminum Body
2015

UNIT PACKAGE: 10



22067

(Ford: W707638-S900C)

Cab, Rear Body, Floor, Door, Box,
Wheel House & Back Panel
Specialty Rivet
1/4" (6.3mm) Diameter
Grip: .060"-.138" (1.5mm - 3.5mm)
Flange Diameter: 1/2" (13mm) Steel
Rivet (Zinc), Steel Mandrel (Zinc) Ford
F-150 Trucks With Aluminum
Body 2015 - On

UNIT PACKAGE: 10



22066

(Ford: W702554-S900C)

Cab, Floor, Door, Pillar, Box & Cowl
Specialty Rivet
1/4" (6.3mm) Diameter
Grip: .268" - .346" (6.8mm – 8.8mm)
Flange Diameter: 1/2" (13mm)
Steel Rivet (Zinc)
Steel Mandrel (Zinc)
Ford F-150 Trucks With Aluminum
Body 2015 - On

UNIT PACKAGE: 10

Additional Application Info



21286

(Ford: W708777-S900C;
Mercedes: 004-990-16-97)

Specialty Rivet
1/4" (6.3mm) Diameter
Grip: 3/16" - 17/64"
(4.80mm - 6.80mm)
Flange Diameter: 1/2" (13mm)
Steel Rivet (Zinc), Steel Mandrel (Zinc)
**Cab, Radiator, Rail, Floor, Door,
Pillar, Cowl, Box & Back Panel**
Ford F-150 Trucks
With Aluminum Body 2015 – On
Mercedes Benz 2008 – On

UNIT PACKAGE: 10



22122

(Mercedes: 003-990-35-97)

Specialty Rivet
6.3mm (1/4") Diameter
Grip Range: 1.0mm - 8.5mm
(.039" - .335")
Flange Diameter:
11mm (7/16")
Aluminum Rivet
Steel Mandrel
Mercedes 2012 – 1990

UNIT PACKAGE: 15



21844

(BMW: 51-11-8-400-709)
Black Nylon

Front Bumper
Nylon Rivet
Diameter: 6mm
Grip: 1mm – 6.5mm
Flange Diameter: 13mm
BMW
1987 – On

UNIT PACKAGE: 25

New

SPECIALTY RIVETS CONTINUED



21861

(BMW: 51-11-1-942-789)
Black Nylon

Nylon Rivet
Diameter: 6mm
Grip: 1mm – 9mm
Flange Diameter: 13mm
BMW
1989 – On

UNIT PACKAGE: 25



22131

(BMW: 07147391324)
White Nylon

Wheel Arch Trim Cover Nylon Rivet
Diameter: 6mm
Grip Range: 1.5mm - 10mm
Flange Diameter: 20mm
BMW X5 2013 – On

UNIT PACKAGE: 25



22147

(BMW: 51777171004)
Black Nylon

Wheel Arch Trim Cover Nylon Rivet
6mm Diameter
Grip Range: 1.5mm - 10mm
Flange Diameter: 20mm
BMW X3, X4, X5 & X6 Series
2006 – On

UNIT PACKAGE: 25



22144

(BMW: 07147391323)
White Nylon

Wheel Arch Trim Cover Nylon Rivet
Diameter: 6mm
Grip Range: 2.5mm - 10.75mm
Flange Diameter: 20mm
BMW X3, X4 & X5 Series
2010 – On

UNIT PACKAGE: 25



22146

(BMW: 07147293278)
Black Nylon

Wheel Arch Trim Cover Nylon Rivet
6mm Diameter
Grip Range: 2.5mm - 10.75mm
Flange Diameter: 20mm
BMW X3, X4 & X5 Series
2010 – On

UNIT PACKAGE: 25



22139

(Ford: N803739-S)
Black Nylon

Nylon Rivet
Diameter: 6.2mm
Flange Diameter: 18mm
Grip Range: 0.70mm - 0.85mm
Fits Into 6.3mm Hole
Ford E150, E250, E350, E450, E550,
Aerostar, Explorer, Ranger, & Tempo
2014 - 1988
Mercury Mountaineer & Topaz
2001 – 1988

UNIT PACKAGE: 25



“6900” Series Quik-Select II Plastic Drawer Assortment

For a complete listing of Quik-Select II Assortments
Refer to page 309 in the Auveco Master Catalog.

6918

Nissan & Infiniti
Nylon Nuts & Screw Grommets
12 Varieties – 235 Pieces

Contains the following Auveco part numbers: **13930,**
13931, 14274, 14275, 14313, 14331, 14335, 14695,
14724, 17196, 17342 & 19293

BODY HARDWARE MASTER METAL DRAWER ASSORTMENTS

New

For a complete listing of Body Hardware Master Assortments refer to pages 270-276 in the Auveco Master Catalog.



6647BHM

Mazda Clips & Fasteners
24 Varieties, 560 Pieces



6648BHM

Mitsubishi Clips & Fasteners
24 Varieties, 520 Pieces



6649BHM

Small Size
Grade 5 USS
Cap Screws,
Nuts & Washers
8 Varieties, 1, 150 Pieces

Auveco Part No.	Description	Auveco Part No.	Description	Auveco Part No.	Description
14260	Push-Type Retainer	13932	Nylon Nut	5434*	1/4"-20 x 1/2"
14274	Nylon Nut	14255	Nylon Nut	5436*	1/4"-20 x 3/4"
14313	Nylon Nut	14275	Screw Grommet	5438*	1/4"-20 x 1"
14367	Trim Panel Retainer	14695	Screw Grommet	5449*	5/16"-18 x 3/4"
14695	Screw Grommet	17195	Grille Clip	5451*	5/16"-18 x 1"
14697	Push-Type Retainer	17351	Push-Type Retainer	5452*	5/16"-18 x 1-1/4"
16000	Push-Type Retainer	17472	Push-Type Retainer	5453	5/16"-18 x 1-1/2"
16858	Push-Type Retainer	18951	Push-Type Retainer	5455	5/16"-18 x 2"
17632	Push-Type Retainer	19140	Push-Type Retainer	15586	1/4"-20 Hex Nut
18206	Push-Type Retainer	19239	Push-Type Retainer	15587	5/16"-18 Hex Nut
18458	Hood Insulation Clip	19320	Retainer	8606	1/4" USS Washer
18692	Weatherstrip Retainer	19323	Retainer	8607	5/16" USS Washer
18824	Trim Panel Retainer	19325	Retainer		
19315	Push-Type Retainer	19334	Retainer		
19481	Weatherstrip Retainer	19485	Nylon Nut		
19747	Push-Type Retainer	20247	Push-Type Retainer		
20465	Push-Type Retainer	20556	Tapping Screw		
20755	Push-Type Retainer	20557	Tapping Screw		
20923	Push-Type Retainer	20565	Grommet		
20932	Trim Panel Retainer	20571	Retainer		
20983	Trim Panel Retainer	20580	Push-Type Retainer		
21024	Push-Type Retainer	21118	Retainer		
21171	Moulding Clip	21140	Push-Type Retainer		
21307	Retaining Clip	21658	Push-Type Retainer		

*Threaded to the head



21845

Air Conditioning
Blue Neoprene
(Teflon Coated)
"O" Ring Assortment

For use with R134A & R12 Refrigerant
6 Varieties - 325 Pieces

Auveco Part No.	Ind Std.	I.D.	O.D.	Thick-ness
18533	108	1/4"	7/16"	3/32"
18534	011	5/16"	7/16"	1/16"
18536	110	3/8"	9/16"	3/32"
18537	013	7/16"	9/16"	1/16"
18539	112	1/2"	11/16"	3/32"
18543	017	11/16"	13/16"	1/16"

New

GENERAL MOTORS CLIPS & FASTENERS



21756

Not Available From O.E.M.
Clear Nylon

Clear version of
Auveco's 11146 Retainer
Head Diameter: 11/16"
Stem Diameter: 5/16"
Stem Length: 13/16"
Universal

UNIT PACKAGE: 50



21674

(GM: 11570830)
White Nylon

Fog Light Grommet
Head Diameter: 16mm
Stem Length: 16mm
Overall Length: 20mm
Fits Into 11mm Hole
Cadillac Escalade, Chevrolet
Avalanche, Camaro, Colorado,
Silverado & Tahoe and GMC Canyon,
Denali, Sierra & Yukon
2005 - On

UNIT PACKAGE: 15



22026

(GM: 25803643)
Natural Nylon

Door Glass To Regulator Grommet
Head Diameter: 13.5mm
Overall Length: 14mm
Buick Allure, LaCrosse &
Verano and Chevrolet Malibu
2010 - On

UNIT PACKAGE: 25



21754

(GM: 11609952)
Magni-565 Plating

Front Bumper
Specialty Nut
Screw Size: M4.2-1.41 (#8)
Head Size: 6mm x 16mm
Overall Height: 7mm
Cadillac Escalade, Chevrolet Tahoe
And GMC Yukon
2007 - On

UNIT PACKAGE: 25



22117

(GM: 11518937)
Zinc Organic

Radiator Grille & Front End Panel Nut
Thread Size: M6-1.0
Overall Height: 11mm
Buick Allure & LaCrosse, Chevrolet
Impala & Monte Carlo,
GMC Sierra & Yukon and
Pontiac Grand Prix
2004 - On

UNIT PACKAGE: 10



22040

(GM: 11610544)
Zinc Organic

Front Fender Panel Nut
M6-1.0 Screw Size
Overall Height: 12mm
Buick Allure, LaCrosse & Regal
2012 - On

UNIT PACKAGE: 10



21753

(GM: 11562503)
Zinc Organic

Specialty Nut
With Plastisol Pad
Screw Size: M6-1.0
Head Size: 13mm x 13mm
Stem Length: 8mm
Chevrolet Truck & GMC
2008 - On

UNIT PACKAGE: 10



22065

(Not Available From O.E.M.)
Black Phosphate

Door & Quarter Glass Channel Clip
Width: 9mm
Length: 16mm
Overall Height: 13mm
GM

UNIT PACKAGE: 50



21745

(GM: 11609651)
Zinc

Windshield Garnish
and Interior Trim
Moulding Fastener
M4.2 (#8) Screw Size
Stem Width: 13mm
Head Size: 13.5mm x 20.5mm
Overall Length: 22mm
Buick Enclave & Encore; Cadillac
CTS, Escalade, STS & XTS; Chevrolet
Avalanche, Camaro, Cobalt, Corvette,
HHR, Impala, Malibu, Monte Carlo,
Silverado, Suburban, Tahoe &
Traverse; Dodge Truck; Ford Flex
& Taurus; GMC Sierra & Yukon;
Kia Sorrento & Soul; Pontiac G6 &
G8; Saturn Outlook and Suzuki Grand
Vitara
2004 - On

UNIT PACKAGE: 15

GENERAL MOTORS CLIPS & FASTENERS CONTINUED

New



22100

(GM: 11612035)
Black Nylon

Front Fender & Body Side Liner
Push-Type Retainer
Head Diameter: 20mm
Stem Length: 12mm
Fits into 8.5mm Hole
Chevrolet Colorado & SS and GMC
Canyon
2014 - On

UNIT PACKAGE: 25



22041

(GM: 92139147)
Black Nylon

Front & Rear Bumper Fascia
Push-Type Retainer
Head Size: 14mm x 21mm
Stem Length: 16mm
Fits Into 8mm Hole
Chevrolet Caprice and
Pontiac G8 & GTO
2011 - 04

UNIT PACKAGE: 25



22025

(GM: 13365058)
Black Nylon

Engine Under Cover Retainer
Head Size: 18mm x 20mm
Stem Length: 30mm
Overall Length: 32mm
Fits Into 10mm x 10.5mm Hole
Buick Lacrosse & Regal,
Cadillac XTS and Chevrolet
Impala, Malibu & Spark
2010 - On

UNIT PACKAGE: 15



22071

(GM: 11546805)
Black Nylon

Front Fender Retainer
Head Diameter: 20mm
Stem Length: 15mm
Snaps Into 8mm Hole
Chevrolet Colorado
2015 - On

UNIT PACKAGE: 50



22031

(GM: 11569700)
Gray Nylon

Trim Panel Retainer
Top Head Diameter: 16.5mm
Middle Head Diameter: 16.5mm
Bottom Head Diameter: 18mm
Stem Diameter: 10mm
Stem Length: 15mm
Cadillac SRX; Chevrolet Equinox &
Tahoe and GMC Denali & Yukon
2010 - On

UNIT PACKAGE: 15



22034

(GM: 11562568)
White Nylon

Windshield Garnish &
Interior Trim Retainer
Top Head Diameter: 19mm
Middle Head Diameter: 19mm
Bottom Head Diameter: 20mm
Stem Diameter: 9mm
Stem Length: 19mm
Buick Enclave, Lucerne & Verano;
Cadillac ATS, CTS, SRX & XTS;
Chevrolet Cruze, Equinox & Traverse
and GMC Acadia & Terrain 2008 - On

UNIT PACKAGE: 10



22021

(Ford: W790225-S900)
Gray Nylon

Fender Corner & Rocker
Moulding Clip
Top Head Size: 16mm x 23mm
Bottom Head Diameter: 17mm
Stem Length: 12mm
Fits Into 9mm Hole
Ford Focus
2012 - On

UNIT PACKAGE: 10



21825

(GM: 11611375)
White Nylon

Moulding Clip With Sealer
Top Head Size: 8mm x 18mm
Bottom Head Diameter: 15mm
Stem Length: 13mm
Fits Into 8mm Hole
Cadillac, Chevrolet & GMC
2014 - 13

UNIT PACKAGE: 15



21793

(GM: 11610495)
White Nylon

Rocker Panel Moulding Clip With Sealer
Top Head Size: 12mm x 20mm
Bottom Head Size: 12mm x 24mm
Stem Length: 14mm
Fits Into 9mm Hole
Chevrolet Camaro 2010 and
Pontiac G6 & Grand Prix
2004 - On

UNIT PACKAGE: 15

New

GENERAL MOTORS CLIPS & FASTENERS CONTINUED



22027

(GM: 11570847)
Yellow Nylon

Lower Door Moulding Clip
With Sealer
Top Head Size:
12.5mm x 20mm
Bottom Head Diameter:
18mm
Stem Length: 11mm
Fits Into 9mm Hole
Cadillac SRX
2010 – On
UNIT PACKAGE: 10



22029

(GM: 11547210)
Green Nylon

Moulding Clip With Sealer
Top Head Size:
12mm x 20mm
Bottom Head Size:
12mm x 20mm
Stem Length: 10mm
Fits into 9mm Hole
Cadillac XTS &
Chevrolet Impala
2014 – 2013
UNIT PACKAGE: 10



22036

(GM: 11546635,
11612122)
Yellow Nylon

Rocker Moulding Clip
With Sealer
Top Head Size:
9mm x 20mm
Bottom Head Size:
14mm x 20mm
Stem Length: 14mm
Fits Into 9mm Hole
Cadillac ATS & CTS
2013 - On
UNIT PACKAGE: 10



22037

(GM: 15864780;
11569921)
Yellow Nylon

Rocker Moulding Clip
With Sealer
Top Head Size:
9.5mm x 20mm
Bottom Head Size:
14mm x 20mm
Stem Length: 20mm
Fits Into 9mm Hole
Cadillac ATS & CTS
2013 - On
UNIT PACKAGE: 10



21681

(GM: 25796285)
White Nylon

Moulding Clip With Sealer
Top Head Size: 6.5mm x 15mm
Bottom Head Size: 13mm x 26mm
Stem Length: 8mm
Fits Into 7mm Hole
Cadillac CTS & Chevrolet Silverado
2007 – On
UNIT PACKAGE: 15



21739

(GM: 11611626)
White Nylon

Tailgate Cover Clip
Top Head Size: 12.5mm x 23mm
Bottom Head Size: 12.5mm x 23mm
Stem Length: 11mm
Fits Into 9mm Hole
Cadillac Escalade, Chevrolet
Avalanche, Silverado, Suburban &
Tahoe And GMC Sierra
2007 – On
UNIT PACKAGE: 25



21827

(GM: 11611435)
White Nylon

Moulding Clip With Sealer
Top Head Size: 22mm x 45mm
Bottom Head Size: 25mm x 37mm
Stem Length: 15mm
Fits Into 10mm Hole
Cadillac, Chevrolet & GMC
2014 – 13
UNIT PACKAGE: 10



22022

(GM: 24405740)
Blue Nylon

Windshield Pillar, Interior &
Trunk Trim Moulding Clip
With Metal Reinforcement
Top Head Size: 17mm x 20mm
Bottom Head Size: 14mm x 28mm
Stem Length: 11mm
Buick Allure, Lacrosse, Regal
& Verano, Cadillac XTS,
Chevrolet Camaro, Caprice,
Cruze, Malibu, Sonic & Volt,
Pontiac G8 and Saturn Astra
2008 – On
UNIT PACKAGE: 15



22024

(GM: 24405739)
Black Nylon

Windshield Pillar & Interior Trim
Moulding Clip
With Metal Reinforcement
Top Head Size: 17mm x 20mm
Bottom Head Size: 14mm x 28mm
Stem Length: 12mm
Buick Allure, Encore, Lacrosse,
Regal & Verano, Cadillac XTS,
Chevrolet Camaro, Caprice,
Cruze, Malibu & Sonic
2010 – On
UNIT PACKAGE: 15



22080

(GM: 11611623)
Blue Nylon

Interior Trim & Windshield Pillar
Moulding Clip With Metal Reinforce-
ment Top Head Size: 17mm x 24mm
Bottom Head Size: 14mm x 28mm
Stem Length: 10mm
Cadillac ATS & Escalade,
Chevrolet Corvette,
Impala & Malibu and GMC Sierra &
Yukon 2013 – On
UNIT PACKAGE: 10

GENERAL MOTORS CLIPS & FASTENERS CONTINUED

New



22035

(GM: 11609292)
Zinc

M6-1.0 Specialty Insert With Sealer
Grip: .5mm - 4.2mm
Head Diameter: 13mm
Hex Size: 9.5mm
Roof Rack & Luggage Carrier
Buick, Chevrolet, GMC,
Hummer & Saturn
2012 - 06

Can be set with Auveco Tool 11805

UNIT PACKAGE: 10



22121

(GM: 11609836)
Tin-Zinc Finish

Specialty Insert
Thread Size: M8-1.25
Grip Range: .70mm - 3.80mm
Head Diameter: 17mm
Hex Size: 12.5mm
General Purpose
Can only be set with Pneumatic Tool
Cadillac XLR & Chevrolet Corvette
1997 - On

UNIT PACKAGE: 10



21740

(GM: 19302122)

Greaseable
Stainless Steel
Door Hinge Pin & Bushing Kit
Repairs One Hinge
(Upper or Lower Hinge)
Extended Cab
Rear Door
GM Full-Size Pickups and SUV's
2006 - 1999

Not Actual Size

UNIT PACKAGE: 1 Kit



21741

(GM: 19301966)

Greaseable Stainless Steel
Door Hinge Pin
& Bushing Kit
Repairs One Hinge
(Upper or Lower Hinge)
Right & Left Rear Door
Chevrolet & GMC
Full-Size Vans
2014 - 1996

Not Actual Size

UNIT PACKAGE: 1 Kit

FORD PRODUCTS CLIPS & FASTENERS



22099

(Ford: W716351-S300)
White Nylon

Wheel Opening & Rocker Moulding
Clip Top Head Size: 12mm x 20mm
Bottom Head Size: 12mm x 20mm
Stem Length: 14mm
Fits Into 9mm Hole Ford
Escape & Lincoln MKC
2013 - On

UNIT PACKAGE: 25



22033

(Ford: W716503-S300)
White Nylon

Rocker Panel & Deck Lid
Moulding Clip With Sealer
Top Head Size: 15mm x 20mm
Bottom Head Size: 20mm x 20mm
Stem Length: 14mm
Fits into 9mm Hole
Ford Fusion & MKZ
2013 - On

UNIT PACKAGE: 25



21790

(Ford: W709688-S300)
Black Nylon

Hood Insulation Retainer
Head Size: 28mm x 30mm
Stem Length: 14mm
Overall Height: 16mm
Ford Focus & Lincoln MKZ
2012 - On

UNIT PACKAGE: 25



21826

(Ford: W711031-S300)
Black Nylon

License Plate & Tail Light
Screw Grommet With Sealer
M6.3 - 1.81 (#14) Screw Size
Head Size: 15mm x 15mm
Stem Length: 22mm
Ford Edge, Explorer, Fiesta,
Flex, Focus, Fusion & Lincoln
2014 - 06

UNIT PACKAGE: 15



22038

(Ford: W716460-S300)
White Nylon

Moulding Clip
Head Size: 11mm x 20mm
Stem length: 11mm
Overall Height: 13.5mm
Ford Fiesta, Fusion &
Mustang and Lincoln MKZ
2010 - On

UNIT PACKAGE: 25



22124

(Ford: W716352-S300)
White Nylon

Rocker Panel &
Door Moulding Clip With Sealer
Top Head Size: 12mm x 20mm
Bottom Head Size: 12mm x 20mm
Stem Length: 14mm
Fits Into 9mm Hole
Ford Edge, Mustang & Mustang G.T.
2015 - On

UNIT PACKAGE: 25

New

FORD PRODUCTS CLIPS & FASTENERS CONTINUED



21794

(Ford: W713579-S300)
White Nylon

Tail Light Mounting Retainer
With Sealer
Top Head Diameter: 15mm
Bottom Head Diameter: 18mm
Stem Length: 12mm
Fits Into 8mm Square Hole
Ford Escape, Explorer, Focus
MKZ & Zephyr
2006 – On

UNIT PACKAGE: 10



22053

(Ford: W715951-S300)
Black Nylon

Rear Body & Interior
Trim Retainer
Head Diameter: 25mm
Stem Diameter: 11mm
Stem Length: 45mm
Ford Escape
2013 - On

UNIT PACKAGE: 15



21703

(Ford: W716510-S300)
Black Nylon

Lower Radiator Shield
Push-Type Retainer
Head Diameter: 18mm
Stem Length: 12mm
Fits Into 7mm Hole
Ford Fusion
2013 – On

UNIT PACKAGE: 10



22058

(Ford: N807673-S)
Black Nylon

Tailgate Push-Type
Retainer
Head Diameter: 14mm
Stem Length: 9mm
Fits into 7mm Hole
Ford Explorer Sport Trac
2010 – 2007

UNIT PACKAGE: 10

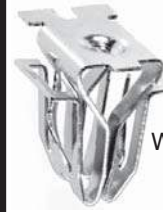

21745

(GM: 11609651)
Zinc

Windshield Garnish and
Interior Trim
Moulding Fastener
M4.2 (#8) Screw Size
Stem Width: 13mm
Head Size: 13.5mm x 20.5mm
Overall Length: 22mm
Ford Flex & Taurus,
Dodge, GM, Kia & Suzuki
2004 – On

UNIT PACKAGE: 15

CHRYSLER PRODUCTS CLIPS & FASTENERS



21835

(Chrysler:
68225214AA)
White Nylon

Moulding Clip
Head Size: 11.5mm x 21mm
Stem Length: 11mm
Overall Height: 17mm
Jeep Cherokee
2014 – On

UNIT PACKAGE: 50



21791

(Chrysler: 68213168AA)
Black Nylon

Grille Moulding Clip
Flange Diameter: 20mm
Stem Diameter: 13mm
Stem Length: 12mm
Overall Length: 31mm
Dodge Ram 1500
2013 – On

UNIT PACKAGE: 15



21738

(Chrysler: 55156655-AA)
Black Nylon

Inner Fender
Moulding Clip With Sealer
Head Size: 12mm x 38mm
Stem Length: 12mm
Fits Into 8mm Hole
Chrysler Sebring, Dodge Avenger
& Durango and Jeep Grand Cherokee
& Liberty 2007 – 02

UNIT PACKAGE: 25



22129

Not Available from O.E.M.
White Nylon

Body Side Moulding Clip
Top Head Size: 4mm x 10.5mm
Bottom Head Diameter: 11mm
Stem Length: 10mm
Fits Into 7mm Hole
Dodge Dart 2014 – On

UNIT PACKAGE: 25



22028

(Chrysler: 4806271-AA)
Black Rubber

Rear Lamp Mounting,
Sensor Bracket &
Interior Trim Grommet
Head Diameter: 15mm
Stem Length: 21mm
Overall Length: 25mm
Fits Into 9mm Hole
Chrysler Mini-Van and Jeep 200,
Caliber, Compass & Patriot
2007 – On

UNIT PACKAGE: 15



21679

(Chrysler: 6509590-AA)
Black Nylon

Bumper Retainer
Head Diameter: 19mm
Stem Diameter: 8mm
Stem Length: 26mm
Chrysler 300 & Charger
2011 – On

UNIT PACKAGE: 25

CHRYSLER PRODUCTS CLIPS & FASTENERS CONTINUED

New



22133

Not Available from O.E.M.
Red Nylon

Fender & Pillar Moulding Retainer With Sealer
Top Head Diameter: 10mm
Bottom Head Diameter: 16mm
Stem Length: 7.8mm
Fits Into 7mm Hole
Ford Edge & Lincoln MKX
2007 – On

UNIT PACKAGE: 10



21680

(Chrysler: 6509960AA)
Black Nylon

Bumper Push-Type Retainer
Head Diameter: 18mm
Stem Length: 10mm
Fits Into 8mm Hole
Chrysler 300
2011 – On

UNIT PACKAGE: 25



21745

(GM: 11609651)
Zinc

Windshield Garnish and Interior Trim Moulding Fastener
M4.2 (#8) Screw Size
Stem Width: 13mm
Head Size: 13.5mm x 20.5mm
Overall Length: 22mm
Ford Flex & Taurus,
Dodge, GM, Kia & Suzuki
2004 – On

UNIT PACKAGE: 15

Not Actual Size



22062

(Not Available From O.E.M.)

Greaseable Stainless Steel Door Hinge Roller Pin & Bushing Repair Kit
Repairs One Hinge
Dodge Ram Full Size Pick-Up
2013 - 2009

UNIT PACKAGE: 1

BMW CLIPS & FASTENERS



22087

(BMW: 51711958025)
Black Nylon

Heater & Air Conditioning Duct Nylon Nut
Screw Size: M4.8 (#10)
Hex Size: 10mm
Flange Diameter: 24mm
Overall Height: 10.3mm
BMW 1, 3, 5, 7, X & Z Series
2012 - 1986

UNIT PACKAGE: 25



21767

(BMW: 51-13-1-829-904,
51-13-6-440-146)
White Nylon

Rocker Panel Moulding Clip
Width: 21mm
Length: 28mm
Stem Length: 6.5mm
3 Series 1993 – 74
5 Series 1981 – 74 and
1602-2002 & 2002Ti 1975 – 67

UNIT PACKAGE: 25



21766

(BMW: 51-13-8-231-130)
White Nylon

Moulding Clip With Blue Rubber Boot
Width: 20.5mm
Length: 35mm
Stem Length: 10.5mm
3 Series
2004 – 1997

UNIT PACKAGE: 25

New

BMW CLIPS & FASTENERS



21765

(BMW: 51-71-8-184-574)
White Nylon

Door Sill & Wheel Housing
Rocker Moulding Clip
Width: 20.5mm
Length: 32mm
Stem Length: 9.5mm
3 Series
2009 – 1991

UNIT PACKAGE: 25



21782

(BMW: 51-11-7-160-451)
White Nylon

Door Sill & Wheel Housing
Rocker Trim Moulding Clip
Width: 30mm
Length: 28mm
Overall Height: 29mm
7 Series
2004 – On

UNIT PACKAGE: 15



22140

(BMW: 51717006757)

Door Seal Clip
Width: 14mm
Length: 36mm
Stem Diameter: 6mm
Stem Length: 6mm
Gray Nylon
BMW 7 Series & X5
2008 – 1998

UNIT PACKAGE: 25



22141

(BMW: 51717066220)
Yellow Nylon

Rocker Panel & Wheel
Housing Trim Cover Clip
Width: 24mm
Length: 22mm
Stem Diameter: 6mm
Stem Length: 10mm
BMW 3, 5 & 6 Series
2004 – On

UNIT PACKAGE: 15



22142

(BMW: 51717066223)
Green Nylon

Rocker Panel & Wheel
Housing Trim Cover Clip
Width: 19mm
Length: 32mm
Stem Diameter: 6mm
Stem Length: 11mm
BMW 5 Series 2010 – 2002

UNIT PACKAGE: 15



22084

(BMW: 07147201307;
51757271848)
Natural Nylon

Heat Shield Screw Grommet
Screw Size: M4.2 (#8)
Head Diameter: 16mm
Stem Length: 13mm
Overall Height: 15mm
BMW 1, 3, 5, 6, 7 & X Series
2012 – 06

UNIT PACKAGE: 15



21763

(BMW: 51-45-8-161-557,
51-45-0-396-330)
Clear Nylon

Interior Trim Instrument
Carrier
Mounting Grommet
With Metal Insert
Head Size: 15mm x 17mm
Stem Length: 13mm
Overall Length: 15mm
3, 5 & 7 Series
1994 – On

UNIT PACKAGE: 15



21764

(BMW:
51-41-700-16-29,
51-41-015-44-20,
51-45-030-47-03,
51-45-816-52-60)
Clear Nylon

Interior Trim Carrier
Mounting Grommet
With Metal Insert
Top Head Size:
12.5mm x 15mm
Bottom Head Size:
15mm x 17mm
Stem Length: 14mm
Overall Length: 18mm
5 & 7 Series
1995 – On

UNIT PACKAGE: 15



21762

(BMW: 07-14-9-158-194,
51-41-821-58-06)
Clear Nylon

Door Lateral Trim Grommet
With Metal Insert
Head Size: 15mm x 17mm
Stem Length: 7mm
Overall Length: 11mm
3 Series
1997 – On

UNIT PACKAGE: 15



21775

(BMW: 51-45-8-266-814)
Red Nylon

Interior Trim Insert Grommet
Head Size: 17mm x 19mm
Stem Length: 9mm
3, 7 & X Series
1997 – On

UNIT PACKAGE: 25



22109

(BMW: 51437194187)
Zinc & Yellow

Trim Retaining Clip
Width: 13mm
Overall Height: 15mm
BMW 3, 5, 7, 8,
X & Z Series
2012 - 1986

UNIT PACKAGE: 25



21757

(BMW: 51-48-8-181-420)
Black Nylon

Trim Panel & Trunk
Lining Retainer
Head Diameter: 18mm
Stem Diameter: 9mm
Stem Length: 15mm
3 Series & 5 Series
2004 – 1988

UNIT PACKAGE: 25

BMW CLIPS & FASTENERS CONTINUED

New



22057

(BMW: 51498123832;
51490151605; 5149810579)
Black Nylon

Trim Panel Retainer
Top Head Diameter: 13mm
Bottom Head Diameter: 18mm
Stem Diameter: 9mm
Stem Length: 12mm
BMW 3, 5, 6, 7, 8, X & Z Series
2012 – 1989

UNIT PACKAGE: 25



21787

(BMW: 51-77-7-171-002)
White Nylon

Wheel Arch Cover & Footboard
Retainer With Sealer
Top Head Diameter: 12mm
Bottom Head Diameter: 18mm
Stem Diameter: 9.5mm
Stem Length: 16mm
BMW X Series
2006 – On
Mini-Cooper S & SX Series
2011 – On

UNIT PACKAGE: 25



21788

(BMW: 51-41-8-224-768,
51-41-0-407-984)
White Nylon

Door Panel Lining &
Rear Window Retainer With Sealer
Top Head Diameter: 14mm
Middle Head Diameter: 15.5mm
Bottom Head Diameter: 18mm
Stem Diameter: 9.5mm
Stem Length: 14mm
BMW X Series 2006 – On
Mini-Cooper 2002 – On

UNIT PACKAGE: 25



22090

(BMW: 51477117532)
Brown Nylon

Scuff Plate Retainer With
Sealer Top
Head Size:
11.6mm x 15mm
Middle Head Size:
11mm x 15mm

Bottom Head Diameter: 20mm
Stem Length: 16mm
Fits into 10mm Hole
BMW 1, 3, 5, 6 & X Series
2012 – 02

UNIT PACKAGE: 15



21854

(BMW: 07-14-7-122-913)
Black Nylon

Rocker Trim
Wheelhouse Retainer
Head Diameter: 20mm
T10 Torx® Drive
Stem Diameter: 7mm
Stem Length: 33mm
1, 3, 6 & X Series
2004 – On

UNIT PACKAGE: 15



21851

(BMW:
51-47-8-116-564,
51-47-2-499-935,
51-47-8-183-031
51-47-1-881-521)
Black Nylon

Floor Mat Lock
Retainer With Washer
Slotted Head Diameter: 18.5mm
Stem Length: 21mm
Washer Diameter: 20.5mm
3, 5, 7 & 8 Series
1997 – On

UNIT PACKAGE: 10



22091

(BMW: 51717066299)
Black Nylon
Door Sill Cover Retainer
Head Diameter: 20mm
T27 Drive
Stem Diameter: 7mm
Stem Length: 24mm
BMW 5 & 6 Series
2011 – 02
UNIT PACKAGE: 15



21777

(BMW: 51-47-1-945-266)
Black Nylon

Trunk Luggage Compartment
& Sill Trim Retainer
Top Head Diameter: 18mm
Bottom Head Diameter: 18mm
Stem Diameter: 5mm x 8mm
Stem Length: 18mm
3, 5 & M Series
1983 – On

UNIT PACKAGE: 25



21776

(BMW: 51-77-7-171-003)
Black Nylon

Rocker Panel & Wheel Housing
Retainer With Rubber "O" Ring
Head Diameter: 25mm
Shoulder Diameter: 14mm
Stem Diameter: 9.5mm
Stem Length: 16mm
X Series
2006 – On

UNIT PACKAGE: 25



22092

(BMW: 51717066226)
Black Nylon

Rocker Moulding & Door Sill Spacer
Cover Retainer
Top Head Diameter: 30mm
Bottom Head Diameter: 18.5mm
Stem Length: 14mm
Overall Length: 27mm
BMW 5 & 6 Series
2011 - 02

UNIT PACKAGE: 15

New

BMW CLIPS & FASTENERS CONTINUED



22086
(BMW: 07147122912)
Black Nylon

Rocker Panel & Wheelhouse
Trim Retainer
Top Head Diameter: 30mm
Bottom Head Diameter: 22mm
Stem Length: 14mm
Overall Length: 32mm BMW 1,
3, 6 & X Series
2012 - 04

UNIT PACKAGE: 15



21780
(BMW: 51-47-8-166-992)
Black Nylon

Trunk Lid Compartment
Trim & Wheel Well
Push-Type Retainer
Head Diameter: 9mm
Stem Length: 7mm
Fits Into 5mm Hole
3, 5, & M Series
1993 - On

UNIT PACKAGE: 25



21779
(BMW: 51-46-7-002-606)
Black Nylon

Front Bumper, Grille,
Trunk Panel
& Rear Window
Push-Type Retainer
Head Diameter: 10mm
Stem Length: 11mm
Fits Into 6.3mm Hole
3, 5, 7 & Z Series
1997 - On

UNIT PACKAGE: 25



**Additional
Application
Information**

20234

(BMW: 51-11-1-908-077;
Mercedes: 000-990-54-92)
Black Nylon

Bumper, Grille, Scuff Plate
& Trim Push-Type Retainer
Head Diameter: 15mm
Stem Length: 15mm
Fits Into 6.3mm Hole
BMW Series 3, 5 & 7
1984 - On
Mercedes-Benz
2014 - 1994

UNIT PACKAGE: 50



22052
(BMW: 51471919209)
Black Nylon

Interior Trim & Engine
Intake Duct
Push-Type Retainer
Head Diameter: 20mm
Stem Length: 17mm
Fits Into 6.3mm Hole
BMW 3, 5, 7, 8, X and Z
Series
2012 - 1984

UNIT PACKAGE: 25



21781
(BMW: 51-71-8-259-788;
51-71-0-391-077)
Black Nylon

Rocker Panel,
Air Duct Compartment
& Wheel Housing
Push-Type Retainer
Head Diameter: 20mm
Stem Length: 16mm
Fits Into 6.3mm Hole
3, 5, 6, 7 & Z Series
1994 - On

UNIT PACKAGE: 25



21778
(BMW: 51-12-7-004-445)
Black Nylon

Rear Bumper
Support Fixture Trim
Push-Type Retainer
Head Diameter: 20mm
Stem Length: 21mm
Fits Into 8.5mm Hole
3, 5 & 6 Series
2002 - On

UNIT PACKAGE: 25

HONDA & ACURA CLIPS & FASTENERS



21700

(Acura: 91626-SP0-003)
Yellow Nylon

Front Pillar & Door Lining
Screw Grommet
With Metal Insert
M5.5 (#12) Screw Size
Head Size: 16mm x 22mm
Overall Height: 17mm
Acura Integra, Legend & RSX
2006 - 1994

UNIT PACKAGE: 15



21796

(Honda: 91503-T2A-A01)
Pink Nylon

Belt Moulding Clip
Width: 20mm
Length: 29mm
Honda Accord
2013 - On

UNIT PACKAGE: 25



21772

(Honda: 76222-SP1-003)
White Nylon

Body Side, Fender Flare,
Roof Garnish & Side Sill
Moulding Clip With Sealer
Top Head Size: 12.5mm x 14mm
Bottom Head Diameter: 14mm
Stem Diameter: 7mm
Stem Length: 8mm
Acura Legend, MDX,
RDX, RL, TL & ZDX
1991 - On
Honda Civic, Element,
Odyssey & Pilot
2004 - On

UNIT PACKAGE: 25



22130

Not Available from O.E.M.
White Nylon

Body Side Moulding Clip
Head Size: 14.5mm x 20mm
Stem Length: 14mm
Fits Into 8mm Hole
Honda CR-V 2012 - On

UNIT PACKAGE: 25

HONDA & ACURA CLIPS & FASTENERS CONTINUED

New



21836

(Honda: 91578-TOA-003)
Yellow Nylon

Bumper Moulding Clip
Head Size: 19mm x 24mm
Stem Length: 15mm
Overall Length: 40mm
Honda CRV
2012 – On

UNIT PACKAGE: 15



21773

(Honda: 91530-S0A-003)
Black Nylon

Roof Rail & Side Sill
Weatherstrip Retainer
Top Head Size: 5mm x 11mm
Bottom Head Diameter: 8mm
Stem Diameter: 6mm
Stem Length: 7mm
Acura Legend, MDX, RDX,
RL, TL & ZDX
1998 – On
Honda Accord, Civic, CRV,
Element & Odyssey
2001 – On

UNIT PACKAGE: 25



21705

(Honda: 90651-TP8-003,
91568-TR0-003)
Yellow Nylon

Weatherstrip Retainer
Top Head Size:
5mm x 15mm
Bottom Head
Diameter: 7.5mm
Stem Diameter: 6.5mm
Stem Length: 7mm
Acura ILX & RDX and
Honda Civic & CR-V
2012 – On

UNIT PACKAGE: 25



21707

(Honda: 91563-SCV-003)
White Nylon

Weatherstrip Retainer
Head Size: 5mm x 15mm
Bottom Head
Diameter: 6.5mm
Stem Diameter: 7mm
Stem Length: 8.5mm
Acura TL and
Honda Element
Odyssey & Pilot
2003 – On

UNIT PACKAGE: 25



21704

(Honda: 72311-S5S-003)
Green Nylon

Weatherstrip Retaining Clip
Top Head Size:
5mm x 15mm
Bottom Head
Diameter: 9.5mm
Stem Diameter: 7mm
Stem Length: 11mm
Acura RDX and
Honda Civic, CR-V & Fit
2003 – On

UNIT PACKAGE: 25



22136

(Honda: 75315-S9A-004)
White Nylon

Lower Outer Door
Weatherstrip Clip
Top Head Size:
12mm x 15mm
Bottom Head Size:
14mm x 20mm
Stem Length: 10mm
Honda CR-V 2002 – On

UNIT PACKAGE: 15



21696

(Honda: 90602-S2A-003)
Pale Yellow Nylon

Cowl Retainer
Top Head Diameter: 12mm
Bottom Head
Diameter: 16mm
Stem Diameter: 4mm
Stem Length: 6.5mm
Honda Civic, Element,
Fit, Insight & S2000
2001 – On

UNIT PACKAGE: 25



22054

(Honda: 91501-SNA-003)
Black Nylon

Front Fender, Cowl & Dash
Retainer
Head Diameter: 20mm
Stem Diameter: 7mm
Stem Length: 16mm
Honda Civic & CR-V
2014 - 06

UNIT PACKAGE: 15



21706

(Honda: 91505-TM8-003)
Black Nylon

Bumper and
Wheel Well Liner
Push-Type Retainer
Head Diameter: 20mm
Stem Length: 14mm
Fits Into 10mm Hole
Acura ILX and
Honda Insight
2012 – On

UNIT PACKAGE: 15



22112

(Honda: 91512-STK-A01)
Black Nylon

Garnish & Rear Spoiler
Push-Type Retainer
With Sealer
Head Diameter: 20mm
Stem Length: 13mm
Fits Into 8.5mm Hole
Acura RDX & TSX and
Honda Accord,
CR-V & Odyssey
2011 - On

UNIT PACKAGE: 10



22068

(Honda: 91513-SJK-003)
White Nylon

Rocker, Pillars, Spoiler,
Garnish & Exterior Trim Push-
Type Retainer With Sealer
Head Diameter: 20mm
Stem Length: 13mm
Fits Into 8.5mm Hole
Acura MDX, RLX, TSX & ZDX
and Honda Accord,
Civic, CR-V, Element,
Fit, Insight & Pilot
2007 - On

UNIT PACKAGE: 15



22069

(Honda: 91512-SJK-003)
White Nylon

Rocker, Pillars, Garnish &
Exterior Trim Push-Type
Retainer With Sealer
Head Diameter: 20mm
Stem Length: 13mm
Fits Into 8.5mm Hole
Acura ZDX 2013 – 2010
Honda Odyssey & Pilot
2005 – On

UNIT PACKAGE: 15

New

HYUNDAI AND KIA CLIPS & FASTENERS



22007

(Hyundai: 84747-2L000)
White Nylon

Trim Panel &
Dash Console Clip
Overall Length: 21mm
Hyundai Elantra, Entourage,
Sonata & Volster
2006 - On
Kia Forte, Sorrento & Soul
2010 - On

UNIT PACKAGE: 50



22014

(Kia: 87758-3E000, 87759-3E000,
87719-02500)
White Nylon

Fender Flare & Door
Moulding Clip With Sealer
Top Head Size: 10.5mm x 9.5mm
Bottom Head Size: 14mm x 17.5mm
Stem Diameter: 14.3mm
Stem Length: 10mm
Kia Sorrento
2009 - 03

UNIT PACKAGE: 25



22010

(Hyundai: 86360-3L000)
White Nylon

Front Hood Moulding Clip
With Sealer
Top Head Size: 10mm x 12mm
Bottom Head Size: 13mm x 15mm
Stem Length: 11mm
Hyundai Azera, Equus & Sonata
2006 - On

UNIT PACKAGE: 25



22015

(Hyundai: 87756-1F000)
Blue Nylon

Fender Flare, Rocker, Door & Exterior
Moulding Clip With Sealer
Top Head Size: 10mm x 12mm
Bottom Head Size: 14mm x 20mm
Stem Diameter: 14mm
Stem Length: 10mm
Hyundai Santa Fe
2013 - On
Kia Sportage
2011 - On

UNIT PACKAGE: 25



22020

(Hyundai: 87770-27000)
White Nylon

Rocker Moulding Clip With Sealer
Top Head Size: 12mm x 15mm
Bottom Head Size: 14mm x 36mm
Stem Diameter: 14mm
Stem Length: 10mm
Hyundai Tiburon
2001 - 1997

UNIT PACKAGE: 25



22019

(Hyundai: 87758-39000)
White Nylon

Rocker Moulding Clip With Sealer
Top Head Size: 16mm x 20mm
Bottom Head Size: 14mm x 18mm
Stem Diameter: 13mm
Stem Length: 10mm
Hyundai Azera, Tiburon &
XG300/350
2011 - 01

UNIT PACKAGE: 25



22013

(Hyundai: 87703-H1000)
Yellow Nylon

Hood Moulding Clip
With Sealer
Top Head Size:
12mm x 16mm
Bottom Head
Diameter: 16mm
Stem Diameter: 9.5mm
Stem Length: 10mm
Hyundai Elantra
2006 - 01

UNIT PACKAGE: 25



22018

(Hyundai: 87756-37000)
White Nylon

Rocker Moulding Clip
With Sealer
Top Head Size:
16mm x 20mm
Bottom Head
Diameter: 15mm
Stem Length: 10mm
Fits Into 9mm Hole
Hyundai Sonata
2005 - 02

UNIT PACKAGE: 25



21863

(Hyundai: 87758-35010)
White Nylon

Moulding Clip With Sealer
Top Head Size:
10mm x 12mm
Bottom Head Size:
14mm x 18mm
Stem Length: 10mm
Hyundai Accent, Kia Soul &
Mitsubishi Outlander
2006 - On

UNIT PACKAGE: 15



22135

(Hyundai: 83219-22000)
White Nylon

Belt Moulding
Weatherstrip Clip
Width: 18.3mm
Length: 29mm
Hyundai Accent 2005 - 1995

UNIT PACKAGE: 25

HYUNDAI AND KIA CLIPS & FASTENERS CONTINUED

New



22017

(Hyundai: 87756-34520)
Green Nylon

Fender & Door Moulding Nylon Nut
Screw Size: M3.5 (#6)
Head Size: 13mm x 13mm
Stem Diameter: 13.5mm
Stem Length: 8mm
Hyundai Tucson
2009 - 05
Kia Optima
2006 - 01

UNIT PACKAGE: 50



22016

(Hyundai: 87756-26900)
White Nylon

Emblem & Rocker Moulding
Nylon Nut With Sealer
Screw Size: M3.5 (#6)
Head Size: 13mm x 13mm
Stem Diameter: 12mm
Stem Length: 10mm
Hyundai Genesis & Santa Fe
2007 - On

UNIT PACKAGE: 50



22011

(Hyundai: 86625-3S000)
White Nylon

Bumper Cover Screw Grommet
With Sealer
Screw Size: M4.8 (#10)
Top Head Size: 14mm x 18mm
Bottom Head Diameter: 18mm
Stem Length: 18mm
Hyundai Santa Fe
2013 - On

UNIT PACKAGE: 25



22003

(Hyundai: 82315-2P000)
White Nylon

Trim Panel Retainer
Top Head Diameter: 13mm
Middle Head Diameter: 15mm
Bottom Head Diameter: 18mm
Stem Diameter: 11mm
Stem Length: 13mm
Hyundai & Kia
1999 - On

UNIT PACKAGE: 50



22009

(Hyundai: 85506-4A000)
White Nylon

Trim Panel &
Window Garnish Retainer
Top Head Diameter: 13mm
Middle Head Diameter: 16mm
Bottom Head Diameter: 15mm
Stem Diameter: 9.6mm
Stem Length: 13mm
Hyundai Tucson &
Kia Sorrento
2003 - On

UNIT PACKAGE: 50



22006

(Hyundai: 82315-36000,
92552-36000)
White Nylon

Trim Panel Retainer
With Sealer
Top Head Diameter: 13mm
Middle Head Diameter: 15mm
Bottom Head Diameter: 18.5mm
Stem Diameter: 10.3mm
Stem Length: 15mm
Hyundai Accent & Elantra
2000 - 1995

UNIT PACKAGE: 25



22004

(Hyundai: 82315-22000)
White Nylon

Trim Panel Retainer
Top Head Diameter: 13mm
Middle Head
Diameter: 16mm
Bottom Head
Diameter: 18mm
Stem Diameter: 9mm
Stem Length: 15mm
Hyundai Accent
1999 - 95

UNIT PACKAGE: 50



22008

(Hyundai: 85495-2E050)
Black Nylon

Headliner Retainer
Top Head Diameter: 14mm
Middle Head
Diameter: 15mm
Bottom Head
Diameter: 16mm
Stem Diameter: 10.3mm
Stem Length: 10mm
Hyundai & Kia

UNIT PACKAGE: 50



22005

(Hyundai: 82315-33020)
White Nylon

Trim Panel Retainer
Top Head Diameter: 15mm
Middle Head
Diameter: 16mm
Bottom Head
Diameter: 18mm
Stem Diameter: 10.7mm
Stem Length: 12mm
Hyundai & Kia
1995 - On

UNIT PACKAGE: 50



22012

(Hyundai:
87378-3N000)
Blue Nylon

License Plate Panel
Retainer With Sealer
Top Head Diameter: 15mm
Middle Head
Diameter: 16mm
Bottom Head
Diameter: 18mm
Stem Diameter: 10.5mm
Stem Length: 39mm
Hyundai Equus
2011 - On

UNIT PACKAGE: 25

New

JAGUAR



22157

(Jaguar: C2D5807)
Yellow Nylon

Rocker Moulding Retainer
Top Head Diameter: 13mm
Middle Head Diameter: 16mm
Bottom Head Diameter: 18mm
Stem Diameter: 12mm
Stem Length: 11mm
Jaguar XJ & XJ-L 2011 – On

UNIT PACKAGE: 15

KIA FASTENER



21745

(GM: 11609651)
Zinc

Windshield Garnish and
Interior Trim
Moulding Fastener
M4.2 (#8) Screw Size
Stem Width: 13mm
Head Size: 13.5mm x 20.5mm
Overall Length: 22mm
Kia Sorrento, Dodge,
Ford, GM & Suzuki
2004 – On

UNIT PACKAGE: 15

LAND ROVER



22154

(Ford: W717736-S300)
White Nylon

Wheel Opening Moulding Clip
Top Head Size: 14mm x 20mm
Bottom Head Size: 14mm x 18mm
Stem Length: 18mm
Fits Into 9mm Hole
Ford F-150 2015 – On

UNIT PACKAGE: 10

LAND ROVER CLIPS & FASTENERS



22145

(Land Rover: DYC000122)
White Nylon

Exterior Rear Door Lower
Moulding Clip With Sealer
Width: 23mm
Length: 39.3mm
Stem Length: 19mm
Range Rover 2012 – 2003

UNIT PACKAGE: 10



22151

(Land Rover: DYC000091)
White Nylon

Lower Side Vent Grille Trim
Moulding Clip With Sealer
Width: 37mm
Length: 40mm
Stem Length: 13mm
Range Rover 2012 – 2003

UNIT PACKAGE: 15



22085

(Land Rover: MWC3136)
White Nylon

Door Panel Grommet
Head Diameter: 14mm
Stem Length: 11mm
Overall Height: 14mm
Fits Into 8mm Hole
Use With Auveco 21770
Discovery, Freelander & Range Rover
2005 – 1995

UNIT PACKAGE: 25



22148

(Land Rover: LR000080)
Black Nylon

Rear Tail Light
Guide Grommet
Head Size: 18mm x 22mm
Stem Length: 15mm
Overall Height: 18mm
Range Rover 2014 – On

UNIT PACKAGE: 25



22150

(Land Rover: LR002229)
Black Nylon

Pillar Post
Moulding Grommet
Head Diameter: 15.5mm
Stem Length: 15mm
Overall Height: 16.5mm
Land Rover Evoque
2012 – 2004

UNIT PACKAGE: 25



21855

(Land Rover: MXC1800)
Black Nylon

Door Panel Retainer
Head Diameter: 10.7mm
Stem Diameter: 5.8mm
Stem Length: 14mm
Defender & Discovery Series
1997-On

UNIT PACKAGE: 15



21770

(Land Rover: MWC9134)
Black Nylon

Side Door
Trim Panel Retainer
Head Diameter: 14mm
Stem Diameter: 6mm
Stem Length: 17mm
Use With Auveco 22085
Defender Series,
Discovery Series, Freelander
& Range Rover
2006 – 1989

UNIT PACKAGE: 25

LAND ROVER CLIPS & FASTENERS CONTINUED

New



22093

(Land Rover: DKP5279L)
Black Nylon
Trim Panel Retainer
Top Head Diameter: 12.3mm Bottom Head Diameter: 12.3mm
Stem Diameter: 5.5mm
Stem Length: 17mm
Land Rover Discovery & Defender
2004 - 1989
UNIT PACKAGE: 25



22152

(Land Rover: LR028939)
White Nylon
Front Lower Fender & Exterior Trim Retainer
Top Head Diameter: 12.5mm
Middle Head Diameter: 16mm
Bottom Head Diameter: 18mm
Stem Diameter: 11.5mm
Stem Length: 10mm
Land Rover Evoque, HSE & Range Rover
2014 - 2012
UNIT PACKAGE: 25



22156

(Land Rover: IPN500050)
White Nylon
Windshield Glass Side Moulding Retainer With Sealer
Top Head Diameter: 13mm
Middle Head Diameter: 15mm
Bottom Head Diameter: 17mm
Stem Length: 13mm
Land Rover HSE & Range Rover Sport
2012 - 2006
UNIT PACKAGE: 15



21853

(VW: 7M0-867-299-K, 7M3-867-299; Land Rover: DYC500020; Ford: 1008068)
Yellow Nylon
Door Trim Panel Retainer With Sealer
Top Head Diameter: 13mm
Bottom Head Diameter: 17.5mm
Stem Diameter: 10.5mm
Stem Length: 15mm
Land Rover 1997 - On
VW & Audi 1999 - On
UNIT PACKAGE: 25



22149

(Land Rover: LR027255)
Blue Nylon
Wheel Arch Moulding Retainer
Top Head Diameter: 14mm
Middle Head Diameter: 15.5mm
Bottom Head Diameter: 18mm
Stem Diameter: 10mm
Stem Length: 16mm
Land Rover Evoque
2012 - 2004
UNIT PACKAGE: 15



22153

(Land Rover: LR032984)
White Nylon
Front Door Louver Exterior Trim Retainer With Sealer
Top Head Size: 8mm x 10mm
Bottom Head Diameter: 15mm
Stem Diameter: 12mm
Stem Length: 8mm
Land Rover Evoque, HSE & Range Rover
2014 - 2012
UNIT PACKAGE: 15



22155

(Land Rover: LR033144)
Black Nylon
Pillar, Rocker & Floor Moulding Push-Type Retainer
Head Diameter: 13mm
Stem Length: 13mm
Fits Into 8mm Hole
Land Rover HSE & Range Rover
2012 - On
UNIT PACKAGE: 15

MAZDA CLIPS & FASTENERS



21743

(Mazda: GJ6A-58-975)
White Nylon
Screw Grommet With Sealer
M4.2 (#8) Screw Size
Head Diameter: 20mm
Stem Length: 15mm
RX-8
2010 - 04
UNIT PACKAGE: 10



22064

(Mazda: H260-50-6K8)
White Nylon
Screw Grommet With Sealer
Screw Size: M4.2-1.41 (#8)
Head Size: 16mm x 22mm
Stem Length: 20mm
Mazda MPV, MX-6, RX-8, 3, 6 & 626
2010 - 1988
UNIT PACKAGE: 15



21755

(Mazda: B003-68-865-00)
Black Nylon
Trim Panel Retainer
Head Diameter: 15mm
Stem Diameter: 6.5mm
Stem Length: 14mm
MPV
1998 - 89
UNIT PACKAGE: 50



21678

(Mazda: NE51-51-SJ3A)
Black Nylon
Moulding Retainer With Sealer
Top Head Diameter: 14mm
Bottom Head Diameter: 18.5mm
Stem Diameter: 12mm
Stem Length: 14mm
CX-9 & Miata
2006 - On
UNIT PACKAGE: 10

New

MAZDA CLIPS & FASTENERS CONTINUED



21769

(Mazda: G14S-50-EA1)
Black Nylon

Push-Type Retainer
Head Diameter: 13mm
Stem Length: 13mm
Fits Into 8mm Hole
CX7 & Miata
2004 - On

UNIT PACKAGE: 25



21858

(Mazda: B467-68-AC3-02)
Black Nylon

Rear Trunk Liner
Push-Type Retainer
Head Diameter: 18mm
Stem Length: 14mm
Fits Into 6mm Hole
5, CX-7, CX-9, Miata,
Millenia, MX-6, RX-7 &
Protégé
1993 - On

UNIT PACKAGE: 25



22049

(Mazda: B27K-51-PS7)
Black Nylon

Headlight Bracket
Push-Type Retainer
Head Diameter: 18mm
Stem Length: 20mm
Fits into 9mm Hole
Mazda 3, CX-7, CX-9,
Miata, MPV & RX-8
2000 - On

UNIT PACKAGE: 15



21862

(Mazda: B455-56-135)
Gray Nylon

Nylon "U" Nut
M4.8 (#10) Screw Size
Center Of Hole
To Edge: 11mm
Panel Range: Up To 1mm
2, 3, 5, 6, 323, 626, 929,
CX-7, CX-9, Miata, Millenia,
MPV, MX-3, MX-5, Protégé,
RX-7 & RX-8
2014 - 1992

UNIT PACKAGE: 25

MERCEDES - BENZ CLIPS & FASTENERS



21759

(Mercedes-Benz:
124-988-94-78)
Black Phosphate
Plated Steel
& White Nylon

Front & Rear Door
Upper Moulding Clip
Nylon Clip: 14.5mm x 47mm
Metal Clip Length: 43mm
300D, 300E, 300TE, 400E & 500E
1995 - 90

UNIT PACKAGE: 10



21843

(Mercedes-Benz:
A901-988-00-25;
VW: 2D1-867-741)
Black Nylon

Rear Entry Scuff Plate
Retaining Pin
Head Size: 15mm x 15mm
Overall Length: 31mm
Mercedes-Benz Sprinter
1995 - On
VW LT Van 2007 - 1987

UNIT PACKAGE: 25



21711

(Mercedes-Benz: 000-991-59-40)
Black Nylon & Santoprene Rubber

Push-Type Retainer
Head Diameter: 11mm
Stem Length: 16mm
Fits Into 6mm Hole
CLS55, CLS500,
C Class, E Class & S-Class
2006 - On

UNIT PACKAGE: 15

**Additional
Application Info**



20234

(BMW: 51-11-1-908-077;
Mercedes: 000-990-54-92)
Black Nylon

Bumper, Grille, Scuff Plate
& Trim Push-Type Retainer
Head Diameter: 15mm
Stem Length: 15mm
Fits Into 6.3mm Hole
Mercedes-Benz 2014 - 1994
BMW Series 3, 5 & 7
1984 - On

UNIT PACKAGE: 50



21859

(Mercedes-Benz: 000-990-
29-92, 000-990-60-92; 001-
990-16-92, 114-990-01-92;
Opel: 1104882, 1719245;
Volvo: 9133417, 1268642)
Black Nylon

Push-Type Retainer
Head Diameter: 16mm
Stem Length: 11mm
Fits Into 8mm Hole
Mercedes-Benz,
Opel & Volvo
1985 - On

UNIT PACKAGE: 15



22115

(Mercedes:
124-988-90-78-M89)
Zinc

Bumper Moulding Clip
Width: 16mm
Length: 19mm
Overall Height: 9mm
Mercedes

UNIT PACKAGE: 25



21823

(Mercedes-Benz:
001-994-98-45)
Zinc

Shield Clip Nut
M4.8-1.61 (#10) Screw Size
Head Size: 10mm x 19mm
Overall Height: 7.5mm
Mercedes-Benz
2002 - On

UNIT PACKAGE: 25

MINI-COOPER CLIPS & FASTENERS

New



21709

(Mini-Cooper: 07-13-1-480-419)
Black Nylon

Rocker Panel Moulding Clip
Top Head Size:
16mm x 20mm
Middle Head
Diameter: 18mm
Bottom Head
Diameter: 23mm
Stem Length: 19mm
Mini-Cooper
2002 - On

UNIT PACKAGE: 15



21716

(Mini-Cooper: 51-71-7-127-742)
Red Nylon

Moulding Clip
Top Head Size:
16mm x 20mm
Middle Head
Diameter: 18mm
Bottom Head
Diameter: 23mm
Stem Length: 21mm
Overall Length: 29mm
R58, R59 & S
2009 - On

UNIT PACKAGE: 15



21787

(BMW: 51-77-7-171-002)
White Nylon

Wheel Arch Cover &
Footboard
Retainer With Sealer
Top Head Diameter: 12mm
Bottom Head
Diameter: 18mm
Stem Diameter: 9.5mm
Stem Length: 16mm
Mini-Cooper S & SX Series
2011 - On
BMW X Series
2006 - On

UNIT PACKAGE: 25



21788

(BMW: 51-41-8-224-768,
51-41-0-407-984)
White Nylon

Door Panel Lining &
Rear Window Retainer
With Sealer
Top Head Diameter: 14mm
Middle Head
Diameter: 15.5mm
Bottom Head
Diameter: 18mm
Stem Diameter: 9.5mm
Stem Length: 14mm
Mini-Cooper
2002 - On
BMW X Series
2006 - On

UNIT PACKAGE: 25

MITSUBISHI CLIPS



22082

(Mitsubishi: MB655630)
Black Nylon

Hood Insulation Retainer
Head Diameter: 26mm
Stem Length: 14mm
Fits Into 9mm Hole
Mitsubishi Diamante & Montero
2004 - 1992

UNIT PACKAGE: 15



21690

(Mitsubishi: MR322000)
White Nylon

Trim Panel Retainer With Sealer
Top Head Diameter: 12mm
Bottom Head Diameter: 16mm
Stem Diameter: 8mm x 8mm
Stem Length: 14mm
Diamante, Eclipse,
Galant, Montero & Outlander
2000 - On

UNIT PACKAGE: 25



22077

(Mitsubishi: MB879499)
Black Nylon

Front Bumper Push-Type Retainer
Head Diameter: 18mm
Stem Length: 9mm
Fits Into 9mm Hole
Mitsubishi Montero
2006 - 01

UNIT PACKAGE: 25

NISSAN & INFINITI CLIPS & FASTENERS



21820

Not Available From O.E.M.
Black Nylon

Nylon Nut
M5.5 (#12) Screw Size
Head Diameter: 15mm
Stem Length: 8mm
Fits Into 8.5mm x 8.5mm Hole
Nissan

UNIT PACKAGE: 50



22059

(Nissan: 76848-54C00)
Black Nylon

Rear Taillight Assembly & Exterior
Rocker Moulding Grommet With Sealer
Head Diameter: 18mm
Stem Diameter: 8.5mm
Stem Length: 14mm
Nissan
2003 - On

UNIT PACKAGE: 25



21688

(Nissan: 01553-02923)
White Nylon

Moulding Grommet With Sealer
Head Size: 14mm x 18mm
Stem Length: 13mm
Infiniti M45 & Q45 and
Nissan Armada, Frontier,
Pathfinder & Xterra
1996 - On

UNIT PACKAGE: 25

New

NISSAN & INFINITI CLIPS & FASTENERS CONTINUED



22123

(Nissan: 85099-1VA0A)
White Nylon

Screw Grommet With Sealer
Screw Size: M5.5 (#12)
Head Diameter: 19mm
Stem Length: 16mm
Overall Length: 20mm
Nissan LEAF, Pathfinder & Rogue
2011 – On

UNIT PACKAGE: 10



21824

(Nissan: 26557-2U001)
Brown Nylon

Screw Grommet With Sealer
M6.3-1.81 (#14) Screw Size
Head Size: 15mm x 19mm
Stem Length: 16mm
Infiniti EX35, G37, JX35, M35, M45,
Q50, QX56, QX60 & QX70 And
Nissan 350Z, 370Z, Altima, Armada,
Cube, Juke, Maxima, Murano,
Pathfinder, Quest, Rouge, Sentra,
Versa & Xterra
2014 – 02

UNIT PACKAGE: 15



21768

(Nissan: 63846-5V000)
White Nylon

Bumper Grommet
With Sealer
M4.8 (#10) Screw Size
Head Diameter: 20mm
Stem Length: 16mm
Overall Length: 22mm
Infiniti FX35, FX45, JX35,
M35, M36, M37, M56 & QX56
And Nissan Altima, Juke,
Maxima, Murano, Quest & Sentra
2003 – On

UNIT PACKAGE: 25



22107

(Nissan: 80850-JM01A)
Black Nylon

Weatherstrip Retainer
Head Size: 6mm x 15mm
Stem Size: 5.6mm x 7mm
Stem Length: 12mm
Overall Length: 16mm
Nissan Rogue
2008 – On

UNIT PACKAGE: 25



22061

(Nissan: 76882-JG10A)
White Nylon

Fender Moulding Clip With Sealer
Top Head Size: 6mm x 12mm
Bottom Head Diameter: 16mm
Stem Length: 10mm
Infiniti Qx80 2014 – On
Nissan Juke
2011 – On

UNIT PACKAGE: 25



22055

(Nissan: 76847-1JB0A)
White Nylon

Moulding Clip With Sealer Top Head
Diameter: 13mm
Bottom Head Diameter: 13mm
Stem Length: 11mm
Nissan Altima, Quest & Sentra
2011 - On

UNIT PACKAGE: 15



21683

(Nissan: 76882-EW00B)
White Nylon

Rocker Moulding & Exterior Trim
Moulding Clip With Sealer
Top Head Size: 6mm x 9mm
Bottom Head Diameter: 13mm
Stem Length: 7mm
Fits Into 8mm Hole
Nissan Altima & Juke
2011 – On

UNIT PACKAGE: 10



22076

(Nissan: 76882-6P010)
Natural Nylon

Hood, Front Fender Bracket & Exterior
Moulding Clip
Top Head Size: 15mm x 15mm
Bottom Head Size: 15mm x 15mm
Stem Length: 15mm
Overall Length: 22mm
Infiniti Q45 2001 – 1996
Nissan Altima & Maxima
2006 – 02

UNIT PACKAGE: 25



22032

(Nissan: 76988-3DN0A)
Green Nylon

Windshield Garnish
Moulding Clip
Overall Length: 44mm
Fits Into 7mm x 12mm Hole
Nissan Altima,
Juke & Sentra
2011 – On

UNIT PACKAGE: 10



21689
 (Nissan: 66820-61U00)
 Black Nylon
 Cowl Grille Retainer
 Head Diameter: 11mm
 Stem Diameter: 4.5mm
 Stem Length: 15mm
 Infiniti M45 & Q45 and
 Nissan Sentra
 1997 – On
 UNIT PACKAGE: 25



22063
 (Nissan: 01553-02903)
 White Nylon
 Front Side Lower Fender
 Panel Bracket Retainer
 Top Head Diameter: 13mm
 Bottom Head Diameter: 12mm
 Stem Length: 14mm
 Overall Length: 21mm
 Infiniti Qx4 & Qx56 and
 Nissan Pathfinder, Frontier & Xterra
 2010 - 1997
 UNIT PACKAGE: 25



22060
 (Nissan: 65810-K2002)
 Black Nylon
 Hood Seal Retaining Clip
 Head Size: 6.5mm x 16mm
 Stem Diameter: 3.5mm x 5.5mm
 Stem Length: 8mm
 Infiniti 2003 - 1997
 Nissan 2003 - 1996
 UNIT PACKAGE: 25



22128
 (Nissan: 66820-9N00A)
 Black Nylon
 Cowl & Dash Retaining Clip
 Width at Bottom Legs: 19mm
 Overall Height: 29.5mm
 Nissan 370Z, Leaf &
 Maxima 2009 – On
 UNIT PACKAGE: 25



21821
 (Nissan: 01553-02253;
 Toyota: 90467-090-6901)
 Black Nylon
 Retaining Clip
 Head Diameter: 14mm
 Stem Diameter: 9.5mm
 Stem Length: 16mm
 Nissan & Toyota
 UNIT PACKAGE: 25



21850
 (Nissan: 26398-ED000)
 White Nylon
 Tail Light Clip
 Top Head Size: 13mm x 13mm
 Bottom Head Diameter: 19mm
 Stem Length: 10mm
 Infiniti M37, M56 & M Hybrid
 2013 – On
 Nissan Armada, Juke, Pathfinder,
 Sentra & Versa
 2006 – On
 UNIT PACKAGE: 25



22075
 (Nissan: 01553-06451)
 Black Nylon
 Upper Quarter Trim &
 Rear Trunk Seal Retainer
 Head Diameter: 20mm
 Stem Diameter: 8.7mm
 Stem Length: 16mm
 Infiniti G35, J30, JX60, M35, M37, M56,
 Q45, Q50 & QX60 and Nissan Altima,
 Pathfinder & Quest
 1996 – On
 UNIT PACKAGE: 25



21701
 (Nissan: 85284-4J500)
 Black Nylon
 Retainer With Sealer
 Top Head Diameter: 13mm
 Middle Head Diameter: 16mm
 Bottom Head Diameter: 18mm
 Stem Diameter: 10mm
 Stem Length: 11mm
 Infiniti I35 and Nissan Altima,
 Cube & Maxima
 2011 – 02
 UNIT PACKAGE: 10



22039
 (Nissan: 01553-2DR9A)
 Black Nylon
 Push-Type Retainer
 Top Head Diameter: 16mm x 19mm
 Bottom Head Diameter: 20mm
 Stem Length: 12mm
 Fits Into 8mm Hole
 Infiniti G20, JX35, Q45 & QX60
 and Nissan Frontier, Maxima, NV,
 Pathfinder, Sentra, Versa & Xterra
 2002 - On
 UNIT PACKAGE: 15

New

SUBARU CLIPS & FASTENERS



22042

(Subaru: 57160FC010)
White Nylon

Upper Front Bumper Extension
Moulding Clip
Top Head Size: 9mm x 11mm
Bottom Head Size: 14mm x 17mm
Stem Length: 11mm
Forester
2005 - 1998

UNIT PACKAGE: 25



22050

(Subaru: 91059FC041)
Gray Nylon

Moulding Clip
Top Head Size: 11mm x 15mm
Bottom Head Size: 14mm x 22.5mm
Stem Length: 13mm
Overall Height: 24mm
Forester
2005 - 1998

UNIT PACKAGE: 25



21771

(Subaru: 90913-0008)
Pink Nylon

Moulding Clip With Sealer
Top Head Size: 11mm x 14mm
Bottom Head Diameter: 17mm
Stem Diameter: 10mm
Stem Length: 11mm
Baja, Forester, Impreza,
Legacy, Outback & Tribeca
2000 - On

UNIT PACKAGE: 25



22044

(Subaru: 66117-9000,
90930-0007)
Yellow Nylon

Nylon Nut
Screw Size: M4.8 (#10)
Head Size: 14mm x 14mm
Stem Length: 7mm
Forester, Impreza,
Justy, Legacy, Outback,
SVX, Tribeca & XV
1987 - On

UNIT PACKAGE: 25



22043

(Subaru: 91084AA010)
White Nylon

Screw Grommet With Sealer
Screw Size: M5.5 (#12)
Head Diameter: 20mm
Stem Length: 18mm
Forester, Impreza,
Legacy, Outback & Tribeca
1995 - On

UNIT PACKAGE: 15



22046

(Subaru: 91167FA010)
Black Nylon

Front Hood Cowl Retaining Clip
Head Size: 9.3mm x 14.5mm
Stem Diameter: 7mm
Stem Length: 16mm
Impreza
2001 - 1993

UNIT PACKAGE: 25



22048

(Subaru: 94078FA080)
White Nylon

Trim Panel Retainer
Top Head Diameter: 13mm
Middle Head Diameter: 16mm
Bottom Head Diameter: 18mm
Stem Diameter:
9mm x 9.5mm
Stem Length: 11mm
Forester, Impreza & XV
Crosstrek
1994 - On

UNIT PACKAGE: 25



22160

(Subaru: 909140062)
Black Nylon

Front & Rear Bumper
Push-Type Retainer
Head Diameter: 15mm
Stem Length: 10mm
Fits Into 7mm Hole
Subaru BRZ, Forester, Im-
preza & XV Crosstrek
2008 - On

UNIT PACKAGE: 15

Additional Application Info



21658

(Mitsubishi: MR288150;
Subaru: 909130013)
Black Nylon

Push-Type Retainer
Head Diameter: 15mm
Stem Length: 11mm
Fits Into 6mm Hole
Mitsubishi Endeavor,
Galant, Lancer, Mirage,
Montero & Outlander
1997 - On
**Subaru BRZ, Forester,
Impreza, Legacy, Outback,
& XV Crosstrek
2004 - On**

UNIT PACKAGE: 10



22047

(Subaru: 94415FA000NE)
Gray & Black Nylon

Rear Roof Spoiler Trim
Push-Type Retainer
Top Head Diameter: 25mm
Bottom Head Diameter: 21mm
Stem Length: 9mm
(Not including The Pin)
Fits Into 8mm Hole
Impreza
2007 - 1998

UNIT PACKAGE: 15

SUZUKI CLIPS & FASTENERS

New



22078

(Suzuki: 83942-65D00)
White Nylon

Liftgate, Exterior Trim &
Garnish Moulding Clip
Top Head Size: 9mm x 10mm
Middle Head Diameter: 12mm
Bottom Head Diameter: 15mm
Stem Length: 11mm
Fits Into 9mm Hole
Suzuki Grand Vitara & XL7
2006 - 1999

UNIT PACKAGE: 25



22079

(Suzuki: 77553-65D10)
White Nylon

Moulding Clip
Head Diameter: 18mm
Stem Length: 9mm
Overall Height: 18mm
Suzuki Grand Vitara, Swift & XL7
1990 - On

UNIT PACKAGE: 15



21691

(Suzuki: 09409-06309-5ES)
Black Nylon

Hood Insulation Retainer
Head Diameter: 24mm
Stem Diameter: 6mm x 6mm
Stem Length: 13mm
Grand Vitara,
Swift & XL7
1990 - On

UNIT PACKAGE: 25



22083

(Suzuki: 09409-08327)
Black Nylon

Front Lights, Cowl & Rear Bumper
Push-Type Retainer
Head Diameter: 16mm
Stem Length: 10mm
Fits Into 8mm Hole
Suzuki Kizashi, SX4 & XL7
2013 - 02

UNIT PACKAGE: 15



21745

(GM: 11609651)
Zinc

Windshield Garnish and
Interior Trim
Moulding Fastener
M4.2 (#8) Screw Size
Stem Width: 13mm
Head Size: 13.5mm x 20.5mm
Overall Length: 22mm
Suzuki Grand Vitara,
Dodge, Ford, GM & Kia
2004 - On

UNIT PACKAGE: 15

TOYOTA & LEXUS CLIPS & FASTENERS



21712

(Toyota: 52535-0E030)
White Nylon

Moulding Clip
Top Head Size: 13mm x 13mm
Stem Length: 22mm
Overall Length: 25mm
Lexus LS 600h & RX 450h
And Toyota RAV4 & 4Runner
2006 - On

UNIT PACKAGE: 15



21857

(Toyota: 75392-35220)
White Nylon

Front & Rear Spoiler
Moulding Clip
Head Size: 10mm x 20mm
Stem Length: 24mm
Overall Length: 27mm
Lexus HS250 & RX350 and Toyota
Camry, Corolla, FJ Cruiser & Highlander
2010 - On

UNIT PACKAGE: 25



21699

(Lexus: 75396-30260)
Natural Nylon

Moulding Clip
With Metal Insert
Head Diameter: 17mm
Stem Length: 10mm
Fits Into 12mm Hole
Lexus LX 470
2007 - 1998

UNIT PACKAGE: 25



21697

(Lexus: 90467-12074)
White Nylon

Moulding Clip
Top Head Size: 10mm x 23mm
Bottom Head Diameter: 18mm
Stem Length: 10mm
Lexus LX 470
2007 - 1998

UNIT PACKAGE: 25



21698

(Lexus: 90467-12071)
White Nylon

Moulding Clip
Top Head Diameter: 12mm
Bottom Head Size: 18mm x 26mm
Stem Length: 10mm
Lexus LX 470
2007 - 1998

UNIT PACKAGE: 25

New

TOYOTA & LEXUS CLIPS & FASTENERS CONTINUED



21748

(Toyota: 75819-33010)
White Nylon

Moulding Clip
With Sealer

Top Head Size: 8mm x 8mm
Bottom Head Diameter: 15mm
Stem Diameter: 10mm
Stem Length: 14mm
Lexus ES300 & ES330 & Scion
And Toyota Camry, Corolla,
Prius, Sequoia, Sienna & Tundra
2002 – On

UNIT PACKAGE: 25



21684

(Toyota: 81496-21010)
Yellow Nylon

Rear Light Housing Guide
With Sealer

Top Head Diameter: 13mm
Bottom Head Diameter: 20mm
Stem Length: 10mm
Toyota Prius
2012 – On

UNIT PACKAGE: 10



21847

(Toyota: 90467-08195)
White Nylon

Front & Rear Fender Flare
Moulding Clip With Sealer

Head Size: 15mm x 22mm
Stem Length: 13mm
Overall Length: 21mm
Lexus GX470 2009 – 03
Toyota Land Cruiser 2007 – 1998

UNIT PACKAGE: 25



21846

(Toyota: 90467-08196)
Yellow Nylon

Front & Rear Fender Flare
And Mudguard

Moulding Clip With Sealer
Head Size: 16mm x 22mm
Stem Length: 19mm
Overall Length: 27mm
Lexus GX470
2009 – 03
Toyota Land Cruiser
2007 – 1998

UNIT PACKAGE: 25



21848

(Lexus: 90467-12072)
Red Nylon

Rocker Moulding Clip With Sealer

Top Head Size: 11mm x 13mm
Bottom Head Size: 25mm x 25mm
Stem Length: 14mm
Lexus LX470
2007 – 1998

UNIT PACKAGE: 25



22127

(Lexus: 81496-50010)
Green Nylon

Rear Lamp Moulding Clip With Sealer

Top Head Diameter: 13mm
Bottom Head Diameter: 20mm
Stem Length: 10mm
Lexus GS 350, GS 450h, LS 460, LS
460 L, LS 600h L, RX 350 & RX 450h
2007 – On

UNIT PACKAGE: 15



21685

(Lexus: 90189-04207)
Yellow Nylon

Outer Wheel Well &
Side Moulding
Screw Grommet

M2.9 (#4) Screw Size
Head Size: 9mm x 9mm
Stem Length: 14mm
Fits Into 7mm x 7mm Hole
Lexus GS300, GS450, LS430,
LS460, SC300 & SC430
1992 – On

UNIT PACKAGE: 25



21792

(Toyota: 90189-06236)
Black Nylon

Fender Liner
Screw Grommet

M5.5 (#12) Screw Size
Head Diameter: 20mm
Stem Length: 17mm
Fits Into 9mm x 9mm Hole
Toyota Echo, RAV4
Tacoma & Scion
2005 – On

UNIT PACKAGE: 25



22096

(Toyota: 52197-22020)
Black Nylon

Rear Bumper Side
Bracket Screw Grommet

Screw Size: M6.3 (#14)
Head Size: 16mm x 18mm
Stem Length: 19mm
Lexus ES 350 &
Hs 250h 2012 – 07
Toyota Avalon & Camry
2012 – On

UNIT PACKAGE: 15

TOYOTA & LEXUS CLIPS & FASTENERS CONTINUED

New



21682
 (Lexus: 52197-30040)
 White Nylon
 Front Bumper Screw
 Grommet With Sealer
 M5.5 (#12) Screw Size
 Head Size: 22mm x 18mm
 Overall Length: 24mm
 Lexus CT200h, GS300, 350,
 430, 460, GS450h, HS250h,
 LS460, 600h, RX350 &
 RX450h
 2006 – On
 UNIT PACKAGE: 15



22158
 (Toyota: 62217-33031)
 Black Nylon
 Windshield Pillar Trim Clip
 Overall Length: 43mm
 Stem Size: 7mm x 12mm
 Stem Length: 12mm
 Toyota Camry 2011 – 2007
 UNIT PACKAGE: 15



22159
 (Toyota:
 90950-08004)
 Black Nylon
 Roof Garnish & Front Pillar
 Post Trim Clip
 Overall Length: 51mm
 Stem Size: 7mm x 12mm
 Stem Length: 12mm
 Toyota Camry, Corolla, High-
 lander, Land Cruiser, Matrix
 & RAV4 2013 – 2004
 UNIT PACKAGE: 15



21695
 (Toyota: 90467-08045,
 90467-08063)
 Black Nylon
 Hood & Weatherstrip
 Retaining Clip
 Head Diameter: 14mm
 Stem Diameter: 9mm
 Stem Length: 11mm
 Toyota Yaris
 2007 – On
 UNIT PACKAGE: 25



21821
 (Nissan: 01553-02253;
 Toyota: 90467-090-6901)
 Black Nylon
 Retaining Clip
 Head Diameter: 14mm
 Stem Diameter: 9.5mm
 Stem Length: 16mm
 Nissan & Toyota
 UNIT PACKAGE: 25



21693
 (Lexus: 90467-05125)
 Black Nylon
 Front Bumper
 Bracket Retainer
 Head Diameter: 16mm
 Stem Diameter:
 4.7mm x 4.7mm
 Stem Length: 12mm
 Lexus GS 300, GS 450h
 & LS 400
 1995 – On
 UNIT PACKAGE: 25



22051
 (Toyota: 90467-11117)
 White Nylon
 Rear Trunk License Plate
 Trim Retaining Nut
 Screw Size: M3.5 (#6)
 Overall Height: 11.5mm
 Width at Bottom: 11mm
 Lexus & Toyota
 2009 – 1998
 UNIT PACKAGE: 15



21692
 (Lexus: 90467-07137)
 Black Nylon
 Fender Panel
 Retaining Clip
 Head Size:
 4.5mm x 11mm
 Stem Diameter: 6.5mm
 Stem Length: 9mm
 Lexus ES 350, GS 300,
 GS 450h & IS 250
 2006 – On
 UNIT PACKAGE: 25



21694
 (Lexus: 67867-50020)
 Black Nylon
 Weatherstrip
 Retaining Clip
 Top Head Size:
 5mm x 14mm
 Bottom Head
 Diameter: 8mm
 Stem Diameter: 6.3mm
 Stem Length: 5mm
 Lexus GS 300 & LS 400
 2005 – 1990
 UNIT PACKAGE: 25



22103
 (Toyota: 53857-47011)
 Black Nylon
 Front Fender
 Retainer With Sealer
 Head Diameter: 20mm
 Stem Diameter: 9mm
 Stem Length: 9mm
 Lexus CT 200h and Toyota
 Camry, Prius, RAV4, Yaris &
 4-Runner 2010 - On
 UNIT PACKAGE: 15



22132
 (Toyota: 53813-48011)
 Gray Nylon
 Front Fender
 Retainer With Sealer
 Top Head Diameter: 20mm
 Bottom Head Diameter: 22mm
 Stem Length: 11mm
 Fits Into 10mm Hole
 Lexus HS 250h, RX 350 &
 RX 450h and Toyota Prius &
 Sienna 2010 – On
 UNIT PACKAGE: 10



21822
 (Peugeot & Citroen: 6822.LL)
 White Nylon
 Door Panel Retainer
 Top Head Diameter: 13mm
 Middle Head
 Diameter: 16mm
 Bottom Head
 Diameter: 18mm
 Stem Diameter:
 8.5mm x 9mm
 Stem Length: 14mm
 Peugeot, Citroen & Toyota
 UNIT PACKAGE: 25

New

TOYOTA & LEXUS CLIPS & FASTENERS CONTINUED



21686

(Toyota: 67771-32120)
Green Nylon

Trim Panel Retainer With Sealer
Top Head Size: 13mm x 16mm
Middle Head Diameter: 16mm
Bottom Head Diameter: 18mm
Stem Diameter: 9mm
Stem Length: 9mm
Lexus ES 300, GS 300, GS 450h,
IS F, IS 250, LS 460, LS 600h, RX
350, Scion XA and Toyota Prius
2001 – On

UNIT PACKAGE: 25



22056

(Toyota: 75867-30130)
White Nylon

Rocker Moulding Retainer With Sealer
Top Head Diameter: 13mm
Bottom Head Diameter: 18mm
Stem Diameter: 8.5mm x 8.5mm
Stem Length: 13mm
Lexus CT 200h, ES 300h, ES 350,
GS 300, GS 350, GS 430, GS 460,
GS 450h, HS 250h, IS 250, IS 350,
IS F, LS 460, LS 600h & LX 570 and
Toyota Land Cruiser
2006 - On

UNIT PACKAGE: 25



21795

(Toyota: 67773-0E020)
White Nylon

Door Panel Retainer
With Sealer
Top Head Diameter: 13mm
Bottom Head (Inc. Sealer)
Diameter: 18mm
Overall Length: 20mm
Fits Into 8.5mm Hole
Lexus RX350 2009 and
Toyota Camry 2012 – On

UNIT PACKAGE: 25



22073

(Toyota: 76924-47020)
Black Nylon

Moulding Retainer
Head Diameter: 32mm
Stem Length: 12mm
Fits Into 22mm Hole
Lexus CT 200h & Toyota
Prius 2011 – On

UNIT PACKAGE: 15



21849

(Toyota: 90467-05136)
Black Nylon

Inner Door Lock Plate,
Engine Cover & Outside Air
Duct Push-Type Retainer
Head Diameter: 13mm
Stem Length: 15mm
Fits Into 5.5mm Hole
Lexus & Toyota
2012 – On

UNIT PACKAGE: 25



22125

(Toyota: 90467-05170)
Black Nylon

Front Bumper
Push-Type Retainer
Head Diameter: 10mm
Stem Length: 10mm
Fits Into 5mm Hole
Lexus IS 250, IS 350 & NX
300h and Toyota Corolla,
Highlander, Matrix & RAV4
2012 – On

UNIT PACKAGE: 25



21702

(Toyota: 90467-10170-C0)
Black Nylon

Cowl Vent, Upper Radiator
Cover & Wheel Apron
Push-Type Retainer
Head Diameter: 18mm
Stem Length: 12mm
Fits Into 10mm Hole
Lexus LS 460, LS 600, RX 350
& RX 450 and Toyota RAV4
2006 – On

UNIT PACKAGE: 10



21856

(Toyota: 51454-48010,
51454-0E010)
Black Nylon

Front Bumper Extension
Mounting Bracket
Push-Type Retainer
Head Diameter: 20mm
Stem Length: 12mm
Fits Into 10mm Hole
Lexus IS CV, F, RX330
& RX400 Hybrid 2006 – On
Toyota Highlander, Sienna
& Venza 2009 – On

UNIT PACKAGE: 15



21860

(Toyota: 51453-48010,
51453-0E010)
Black Nylon

Front Side Lower
Fender Panel Bracket
Push-Type Retainer
Head Diameter: 22mm
Stem Length: 14mm
Fits Into 13mm Hole
Lexus RX330 2009-2004
Toyota Highlander 2010 – On

UNIT PACKAGE: 15



22126

(Toyota:
53384-68010)
Black Nylon

Front Grille
Push-Type Retainer
Rubber Head Diameter: 19mm
Bottom Head Diameter: 18mm
Stem Length: 28mm
Fits Into 9mm Hole
Scion tC & Toyota RAV4
2005 – On

UNIT PACKAGE: 15

TOYOTA & LEXUS CLIPS & FASTENERS CONTINUED

New



22072

(Toyota: 76923-47010)
Black Nylon

Rocker Moulding Push-Type Retainer
Head Diameter: 38mm
Stem Length: 32mm
Fits Into 22mm Hole
Lexus HS 250h & CT 200h
and Toyota Prius
2010 - On

UNIT PACKAGE: 5



21687

(Toyota: 90467-05138)
Black Nylon

Front Bumper & Fender Liner
Nylon "U" Nut
M6.3 (#14) Screw Size
Panel Range: Up To 3mm
Center Of Hole To Edge: 14mm
Lexus GX 460, GX 470 & LX 570,
Scion tC and Toyota Corolla,
FJ Cruiser, Land Cruiser,
Matrix, Sequoia, Tacoma,
Tundra & 4 Runner
2003 - On

UNIT PACKAGE: 15



22102

(Toyota: 53271-12040; 53271-12060;
53271-0B010)
Black Nylon

Headlight Bracket Clip
Width: 25mm
Length: 39mm
Overall Height: 33mm
Lexus GX460, GX470, RX 300, RX 330
& RX 350 and Toyota Corolla, Echo,
Highlander, MR2, Prius,
Tacoma, Tercel & 4-Runner
1993 - On

UNIT PACKAGE: 10



21797

(Toyota: 53879-30040)
Black Nylon

Front Bumper Cover Clip
Width: 32mm
Length: 39mm

Use With Auveco No. 21357

Lexus CT200h & HS250h
2010 - On
Toyota Camry 2012 - On

UNIT PACKAGE: 5



22097

(Toyota: 90950-01620)
Black Nylon

Hole Plug
Head Diameter: 30mm
Height: 5.6mm
Lexus ES, RX & SC; Scion iQ, tC, xA, xB
& xD and Toyota Avalon, Camry,
Celica, Corolla, FJ Cruiser, Highlander,
Matrix, Prius, RAV4, Sequoia, Sienna,
Tacoma, Tundra & Yaris
1984 - On

UNIT PACKAGE: 15

VOLKSWAGEN & AUDI CLIPS & FASTENERS



21761

(VW: 3C0-853-585,
3C9-827-407, 3C9-827-408)
White Nylon

Upper Door Cover Strip Scuff Protection
Moulding Clip
Top Head Size: 13mm x 16mm
Bottom Head Diameter: 14mm
Stem Length: 13mm
Fits Into 9mm Hole
Passat, Tiguan & Toureg
2006 - On

UNIT PACKAGE: 25



22098

(VW: 4F0-805-163)
Zinc

Sub Frame Clip
Width: 13mm
Length: 27mm
Audi A6 & S6 and Volkswagen
2005 - On

UNIT PACKAGE: 10



22116

(VW: 1J6-867-276)
Zinc Finish

Door Trim Clip
Overall Height: 22.5mm
Width at Bottom Base: 13.5mm
Audi & VW
2004 - On

UNIT PACKAGE: 25

New

VOLKSWAGEN & AUDI CLIPS & FASTENERS CONTINUED



21760

(VW: 6Q0-868-246-A)
White Nylon

Moulding Clip
Width: 25mm
Length: 40mm
Thickness: 8mm
Audi 2004 – On
Eos, Golf, GTI, Passat,
R32 & Rabbit
2005 – On

UNIT PACKAGE: 25



21843

(Mercedes-Benz:
A901-988-00-25;
VW: 2D1867741)
Black Nylon

Rear Entry Scuff Plate
Retaining Pin
Head Size: 15mm x 15mm
Overall Length: 31mm
VW LT Van
2007 – 1987
Mercedes-Benz Sprinter
1995 – On

UNIT PACKAGE: 25



21842

(VW: N90565301,
N90642001)
Black Nylon

Engine Compartment Cover
Locking Duo Drive
Pin Retainer
Head Diameter: 15.7mm
Shoulder Diameter: 8.8mm
Shoulder Length: 6.5mm
Overall Length: 27mm
Audi A4, A6 & A8, SEAT,
Skoda and VW Passat

UNIT PACKAGE: 25



21789

(VW: 1H0-867-199-01C)
Black Nylon

Radiator Grille, Scuff Plate,
Sill & Trim Panel Retainer
Head Diameter: 23mm
Stem Diameter: 11mm
Stem Length: 16mm
Volkswagen & Audi
1997 – On

UNIT PACKAGE: 25



21758

(VW: 801-867-299-01C)
Black Nylon

Door Side Panel,
Luggage Compartment
And Armrest Tray Trim
Retaining Clip
Head Diameter: 14mm
Stem Diameter: 7mm x 9mm
Stem Length: 18mm
Golf, GTI, Jetta & Rabbit
2005 – 1999

UNIT PACKAGE: 25



21853

(VW: 7M0-867-299-K, 7M3-867-299;
Land Rover: DYC500020;
Ford: 1008068)
Yellow Nylon

Door Trim Panel Retainer With Sealer
Top Head Diameter: 13mm
Bottom Head Diameter: 17.5mm
Stem Diameter: 10.5mm
Stem Length: 15mm
VW & Audi 1999 – On
Land Rover 1997 – On

UNIT PACKAGE: 25



21783

(VW: 6Q0-868-297)
Black Nylon

Trim Panel Retainer
Top Head Diameter: 16mm
Bottom Head Diameter: 16mm
Stem Diameter: 10mm
Stem Length: 9mm
Golf, GTI, R32 & Rabbit
2006 – On

UNIT PACKAGE: 15



21708

(VW: 7L6-868-243)
Black Nylon

Door Trim Panel
Retainer With Sealer
Head Diameter: 22.5mm
Stem Diameter: 9mm
Stem Length: 12mm
Audi A5, A6, A7, S5, S6 & S7
And VW Beetle, Cabrio, Golf,
Gti, Jetta, Passat & Touareg
2004 – On

UNIT PACKAGE: 15



22101

(Audi: 4D0-807-300)
Black Nylon

Bumper, Fender & Hood
Insulation Push-Type Retainer
Head Diameter: 22mm
Stem Length: 12mm
Fits Into 7.5mm Hole
Audi A4, A5, A8, Q3, Q5 & S8
1997 - On

UNIT PACKAGE: 15



22095

(Audi: N90-229-301)
Black Nylon

Hood Insulation
Push-Type Retainer
Head Diameter: 22mm
Stem Length: 13mm
Fits into 8mm Hole
Audi & Volkswagen
1986 – On

UNIT PACKAGE: 25

VOLKSWAGEN & AUDI CLIPS & FASTENERS CONTINUED

New



21815

(VW: 4A0-805-163,
8A0-863-821Q)
Black Nylon

Upper & Lower Engine Cover
Locking Pin Grommet
Overall Width: 20mm
Overall Height: 16mm
VW, Audi, SEAT & Skoda
1998 - On

UNIT PACKAGE: 25



22094

(VW: 4L0-886-373)
White & Black Nylon

Front & Rear Seat Bottom
and Bench Grommet
Top Head Size: 27.6mm x 40mm
Bottom Head Size: 25mm x 37mm
Stem Length: 30mm
Overall Length: 40mm
Audi & Volkswagen
2013 - 2007

UNIT PACKAGE: 10



22108

(VW: 4A0-867-276A)
Zinc

Trim Moulding Clip
Overall Height: 16mm
Audi & Volkswagen
2012 - 1998

UNIT PACKAGE: 25

VOLVO CLIPS & FASTENERS



21786

(Volvo: 30653441)
Black & White Nylon

Door Trim, Luggage Compartment
& Armrest Tray Trim Retainer
Top Head Diameter: 13mm
Middle Head Diameter: 13mm
Bottom Head Diameter: 17mm
Stem Diameter: 8mm
Stem Length: 9mm
C30, S40, V50, V60 & XC60
2004 - On

UNIT PACKAGE: 25



21785

(Volvo: 30624192)
Black & Yellow Nylon

Rocker Panel
Moulding Retainer
Top Head Diameter: 16mm
Middle Head Diameter: 17.5mm
Bottom Head Diameter: 17mm
Stem Length: 9mm
Fits Into 8mm Hole
S60 & V60
2011 - On

UNIT PACKAGE: 25



21784

(Volvo: 30784514)
White Nylon

Moulding Clip
Top Head Size: 15mm x 17mm
Bottom Head Size: 9mm x 16mm
Stem Length: 11mm
Fits Into 8mm Hole
S80, V70, XC70 & XC90
2007 - On

UNIT PACKAGE: 25



22138

(Volvo: 30753487)
Metal & White Nylon

Pillar & Exterior Trim
Glass Weatherstrip Clip
Overall Length: 49mm
Volvo XC60
2008 - On

UNIT PACKAGE: 10



22137

(Volvo: 30753556)
Metal & White Nylon

Pillar & Exterior Trim
Glass Weatherstrip Clip
Overall Length: 60mm
Volvo V70 & XC70
2008 - On

UNIT PACKAGE: 10



21859

(Mercedes-Benz: 000-990-29-92,
000-990-60-92, 001-990-16-92,
114-990-01-92; Opel: 1104882,
1719245; Volvo: 9133417, 1268642)
Black Nylon

Push-Type Retainer
Head Diameter: 16mm
Stem Length: 11mm
Fits Into 8mm Hole
Mercedes-Benz, Opel & Volvo
1985 - On

UNIT PACKAGE: 15

New

CLIPS & FASTENERS FOR VEHICLES WITH EUROPEAN APPLICATIONS

Renault, Dacia & Fiat



21800

(Renault: 77-03-077-080)
Black Nylon

Retainer
Head Diameter: 13mm
Stem Diameter: 7mm
Stem Length: 15mm
Renault and Dacia

UNIT PACKAGE: 25



21801

Not Available From O.E.M.
White Nylon

Retainer
Head Diameter: 13mm
Stem Diameter: 7mm
Stem Length: 17mm
Renault and Dacia

UNIT PACKAGE: 25



21802

(Renault: 77-03-077-231;
Fiat: 14591787)
Black Nylon

Retainer
Head Diameter: 15mm
Stem Diameter: 8mm
Stem Length: 17mm
Renault, Dacia and Fiat

UNIT PACKAGE: 25



21803

(Fiat: 14592087)
Black Nylon

Retainer
Head Diameter: 20mm
Stem Diameter: 8mm
Stem Length: 23mm
Renault, Dacia and Fiat

UNIT PACKAGE: 25



21804

(Fiat: 14592086)
Gray Nylon

Retainer
Head Diameter: 20mm
Stem Diameter: 8mm
Stem Length: 23mm
Renault, Dacia and Fiat

UNIT PACKAGE: 25



21805

(Renault: 77-03-077-435)
Black Nylon

Retainer
Head Diameter: 35mm
Stem Diameter: 10mm x 10.5mm
Stem Length: 22mm
Renault and Dacia

UNIT PACKAGE: 25



21806

(Renault: 77-03-077-225)
Black Nylon

Retainer
Head Diameter: 35mm
Stem Diameter: 10.5mm
Stem Length: 22mm
Renault and Dacia

UNIT PACKAGE: 25



21814

(Peugeot: 6991.S6;
Renault: 77-03-077-468)
White Nylon

Door Panel Retainer
Top Head Diameter: 13mm
Middle Head Diameter: 16mm
Bottom Head Diameter: 18mm
Stem Diameter: 12mm
Stem Length: 11mm
Renault, Dacia, Peugeot
And Citroen

UNIT PACKAGE: 25



21807

(Renault: 77-03-072-360)
Black Nylon

Push-Type Retainer
Head Diameter: 18mm
Stem Length: 14mm
Fits Into 8mm Hole
Renault and Dacia

UNIT PACKAGE: 25



21812

(Peugeot & Citroen:
16-092-672-80;
Renault: 77-03-072-416)
Black Nylon

Push-Type Retainer
Rectangular Head Size: 9mm x 20mm
Head Diameter: 20mm
Stem Length: 13mm
Fits Into 8mm Hole
Renault, Dacia, Peugeot
And Citroen

UNIT PACKAGE: 25

Peugeot & Citroen



21813
(Peugeot & Citroen: 6973.A9)
Black Nylon

Nylon Rivet
4mm Diameter
Grip: 1.2mm – 6.5mm
Flange Diameter: 9mm
Peugeot & Citroen

UNIT PACKAGE: 25



21808
(Peugeot & Citroen: 6992.31)
White Nylon

Interior Trim Retainer
Head Diameter: 10mm
Stem Diameter: 8mm
Stem Length: 15mm
Peugeot & Citroen

UNIT PACKAGE: 25



21809
(Peugeot & Citroen: 6983.17)
Black Nylon

Retainer
Head Diameter: 21mm
Stem Diameter: 7.5mm
Stem Length: 23mm
Peugeot & Citroen

UNIT PACKAGE: 25



21822
(Peugeot & Citroen: 6822.LL)
White Nylon

Door Panel Retainer
Top Head Diameter: 13mm
Middle Head Diameter: 16mm
Bottom Head Diameter: 18mm
Stem Diameter: 8.5mm x 9mm
Stem Length: 14mm
Peugeot, Citroen & Toyota

UNIT PACKAGE: 25



21814
(Peugeot: 6991.S6;
Renault: 77-03-077-468)
White Nylon

Door Panel Retainer
Top Head Diameter: 13mm
Middle Head Diameter: 16mm
Bottom Head Diameter: 18mm
Stem Diameter: 12mm
Stem Length: 11mm
Renault, Dacia, Peugeot And Citroen

UNIT PACKAGE: 25



21810
(Peugeot & Citroen: 6997.T2)
Black Nylon

Push-Type Retainer
Head Diameter: 22mm
Stem Length: 14mm
Fits Into 6.3mm Hole
Peugeot & Citroen

UNIT PACKAGE: 25



21811
(Peugeot & Citroen: 8211.WV)
Black Nylon

Push-Type Retainer
Head Diameter: 20mm
Stem Length: 10mm
Fits Into 8mm Hole
Peugeot & Citroen

UNIT PACKAGE: 25



21812
(Peugeot & Citroen: 16-092-672-80;
Renault: 77-03-072-416)
Black Nylon

Push-Type Retainer
Rectangular Head Size: 9mm x 20mm
Head Diameter: 20mm
Stem Length: 13mm
Fits Into 8mm Hole
Renault, Dacia, Peugeot And Citroen

UNIT PACKAGE: 25

VW, Audi, SEAT, Skoda & Ford



21817
(VW: N908-131-01)
Natural Nylon

Nylon Rivet
6mm Diameter
Grip: 2.0mm – 8.5mm
Flange Diameter: 13mm
VW, Audi, SEAT & Skoda

UNIT PACKAGE: 25



21816
(VW: 6N0-809-966A)
Black Nylon

Screw Grommet
M4.8 (#10) Screw Size
Head Diameter: 12mm
Stem Length: 15mm
Fits Into 6.5mm x 8mm Hole
VW, Audi, SEAT & Skoda

UNIT PACKAGE: 25



21815
(VW: 4A0-805-163,
8A0-863-821Q)
Black Nylon

Upper & Lower Engine Cover
Locking Pin Grommet
Overall Width: 20mm
Overall Height: 16mm
VW, Audi, SEAT & Skoda
1998 - On

UNIT PACKAGE: 25

New

CLIPS & FASTENERS FOR VEHICLES WITH EUROPEAN APPLICATIONS

VW, Audi, SEAT, Skoda & Ford Continued



21818

(VW: 4A0-867-276)
Black Spring Steel

Moulding Fastener
Overall Height: 22mm
VW, Audi, SEAT & Skoda

UNIT PACKAGE: 25



21819

Yellow Nylon

Retainer
Top Head Diameter: 13mm
Bottom Head Diameter: 17.5mm
Stem Diameter: 10mm
Stem Length: 16mm
VW, Audi, SEAT, Skoda & Ford

UNIT PACKAGE: 25



21842

(VW: N90565301,
N90642001)
Black Nylon

Engine Compartment Cover
Locking Duo Drive
Pin Retainer
Head Diameter: 15.7mm
Shoulder Diameter: 8.8mm
Shoulder Length: 6.5mm
Overall Length: 27mm
Audi A4, A6 & A8, SEAT
Skoda and VW Passat

UNIT PACKAGE: 25

Auveco-Flex Epoxy Repair Kit



1005

A two part high strength epoxy adhesive, filler and surface designed for bonding or repairing urethane bumpers, TPO Bumpers, filler panels and most other flexible plastic parts.

Working Time: 5 minutes approximately
Sandable: 15 to 30 minutes
Paintable: 15 minutes
Cures: 6 to 8 hours
Shelf life: 12months

1 Each of Part 1 Resin (Black) & Part 2 Hardener (White)
10 fl. Oz. kit

UNIT PACKAGE: 2 Tubes

Auveco-Rigid - Set Epoxy Repair Kit



1006

A two part high strength epoxy adhesive, filler and surface designed for bonding or repairing SMC, rigid plastics, fiber-glass, steel, aluminum, glass and other rigid type materials.

Working Time: 5 minutes approximately
Sandable: 15 to 30 minutes
Paintable: 15 minutes
Cures: 6 to 8 hours
Shelf life: 12 months

1 Each of Part 1 Resin (Blue) &
Part 2 Hardener (Light Gray)
10 fl. oz kit

UNIT PACKAGE: 2 Tubes

O.E.M. INTERCHANGE BY MANUFACTURER

The O.E.M. numbers listed in this interchange are cross referenced to the closest equivalent Auveco part. In some instances, the parts are not identically the same. There may be slight differences in the finished, length, washer O.D.: however, the Auveco part is designed to service the same application.

This interchange is not listed in strict numerical order (from the lowest number to the highest number.) Rather it is arranged in numerically ascending order from the left regardless of the number of digits in each O.E.M. number. Thus every number that begins with a 1 is listed before any number that begins with a 2. You should key on the first four digits to locate the number. For example, 1121865 is located before 11229 and after 11189734. OEM numbers that begin with a letter precede OEM numbers that begin with a numeral.

O.E.M. No.	Auveco No.	Page No.	O.E.M. No.	Auveco No.	Page No.	O.E.M. No.	Auveco No.	Page No.	O.E.M. No.	Auveco No.	Page No.
AC-DELCO			91527-SP1-003.....	18757	568	4157	B4157	206	1638	20295	202
L562	20402	252	91528-SP1-003.....	18758	569	4157K	B4157K	206	168	16921	201
L891	20598	204	91530-S0A-003.....	21773	NI 17	53	B53	206	17131	20589	202
LS101	9883	174	91533-ST0-003.....	19668	568	57	B57	206	17171	20590	202
PT516	13547	182	91535-SP0-003.....	18754	569	67	B67	206	17177	20591	202
PT549	11440	182	91537-SP0-013.....	18236	570	67A	B67A	206	17635	20592	202
16-7552	9481	150	91558-SE3-003.....	21388	574	68	B68	206	17916	20593	202
614	12629	163	91560-S9A-A01.....	20959	394	7440	B7440	206	1815	18474	201
616	12628	163	91560-SLJ-J01.....	21208	393	7440A	B7440A	206	1816	16919	201
ACURA			91560-SZ3-003.....	19466	393	7443	B7443	206	1889	18003	201
33115-S84-A01.....	16897	203	91561-SW5-003.....	19479	570	7443A	B7443A	206	1891	18002	201
33116-SL0-003.....	BD2C	208	91563-SCV-003.....	21707	NI 17	880	B880	207	1893	16909	201
33116-S77-003.....	BD2S	209	91568-SL4-003.....	17608	570	881	B881	207	1895	16906	201
33303-S30-003.....	19206	201	91568-TR0-003.....	21705	NI 17	884	B884	207	192	20286	202
33303-SL4-003.....	19206	201	91591-SJ6-013.....	21170	574	885	B885	207	193	18013	201
34906-S30-003.....	19207	201	91601-STX-A00.....	21209	571	886	B886	207	194	16902	201
34906-ST5-003.....	19207	201	91641-SH3-013.....	19679	587	889	B889	207	194NA	18012	201
35113-SEC-A01.....	21079	561	91651-SZ3-003.....	19463	571	89	B89	206	198	16924	201
72311-S5S-003.....	21704	NI 17	91652-SP0-003.....	19465	570	890	B890	207	199	18466	201
75305-S0A-003.....	20783	579	91652-SZ3-003.....	19746	365	891	B891	207	2040	19209	204
75305-SH2-003.....	20784	579	ALCOA, EUCLID			893	B893	207	2057	16907	201
75305-SH4-003.....	20785	579	5988-L	15010	86	894	B894	208	2057NA	16908	201
75315-STK-A01.....	21204	567	5988-R	15009	86	896	B896	208	211-2	16913	201
75316-S9A-004.....	21557	578	ALEMITE			899	B899	208	212-2	18011	201
76222-SP1-003.....	21772	NI 16	1641-B	9257	228	9004	B9004	208	222	20287	202
80871-ST7-000.....	18141	331	AUTOMOTIVE BULBS			9005	B9005	208	2357	17999	201
80872-ST7-000.....	18140	331	Industry Standard Number To			9006	B9006	208	2357NA	18000	201
80873-ST7-000.....	18137	331	Auveco's High Performance			9007	B9007	208	2396	17998	201
90001-SG0-003.....	14291	383	Imported Bulb No.			9008	BH13	209	24	18017	201
90009-PH1-000.....	21353	224	D1S	BD1S	208	906	B906	206	24NA	18018	201
90107-S0X-A01.....	21521	588	D2C	BD2C	208	906A	B906A	206	293	18467	201
90505-SL0-003.....	19140	635	D2R	BD2R	209	912	B912	206	3057	16915	201
90601-SK7-003.....	18759	568	D2S	BD2S	209	9145	BH10	209	3057NA	16916	201
90602-SEP-A00.....	21131	398	H1	BH1	209	916	B916	206	3155	17997	201
90602-SFA-004.....	21308	567	H10	BH10	209	916A	B916A	206	3156	17996	201
90602-SX0-003.....	21107	388	H11	BH11	209	921	B921	206	3156NA	18475	201
90602-TA0-003.....	21417	572	H13	BH13	209	921A	B921A	206	3157	16917	201
90621-SK7-003.....	18756	568	H3	BH3	209	97	B97	206	3157NA	18001	201
90651-TP8-003.....	21705	NI 17	H7	BH7	209	AUTOMOTIVE BULBS			3157NA-SA	18476	201
90661-ST7-003.....	18456	570	H9	BH9	209	Industry Standard Number To			3157SA	18479	201
90666-SA7-003ZW.....	19506	367	HB1	B9004	208	Auveco's Wagner Bulb No.			3357	18477	201
90666-SS0-003.....	19740	581	HB3	B9005	208	H3	20600	204	3357NA	18478	201
90667-SD4-003.....	19464	388	HB4	B9006	208	H4	20601	204	3457	20587	202
90675-SA5-003.....	22105	NI 3	HB5	B9007	208	HB1	16896	203	3457NA	20588	202
90682-SEA-003.....	20954	587	1141	B1141	206	HB2	18661	203	3496	20296	202
90688-SB0-013.....	14698	596	1156	B1156	206	HB3	16897	203	3497	20297	202
90700-SJ4-000.....	18746	378	1156A	B1156A	206	HB4	16898	203	3652	20298	202
91501-SG0-003.....	17440	567	1157	B1157	206	HB5	18662	203	37	18465	201
91501-SL4-003.....	19467	383	1157A	B1157A	206	PR2	16927	201	3757NALL	20859	202
91501-SP1-003.....	19225	567	1255	BH3	209	1003	16918	201	4157LL	20620	202
91502-SZ5-003.....	19232	573	168	B168	206	1004	16920	201	4157NALL	20621	202
91503-S0K-A01.....	20608	594	1893	B1893	206	1034	16925	201	53	16914	201
91503-SK7-013.....	19723	571	1895	B1895	206	1073	18004	201	55	20282	202
91503-SP0-003.....	17267	573	194	B194	206	1076	18469	201	558	20288	202
91503-SZ3-003.....	19233	573	194A	B194A	206	11005	20299	202	561	18010	201
91503-SZ5-003.....	20564	595	2057	B2057	206	11006	20300	202	562	20289	202
91504-SP1-003.....	21558	579	2057A	B2057A	206	1141	16923	201	57	16910	201
91505-SL0-003.....	19231	573	2357	B2357	206	1142	20681	202	63	20283	202
91505-TM8-003.....	21706	NI 17	2357A	B2357A	206	1155	18470	201	631	18468	201
91506-S9A-003.....	21173	573	24	B24	206	1156	16904	201	67	16905	201
91512-S50-003.....	21555	579	24A	B24A	206	1156NA	17597	201	68	20292	202
91512-SJ6-J01.....	21559	578	3057	B3057	206	1157	16899	201	73	20284	202
91512-SJK-003.....	22069	NI 17	3057A	B3057A	206	1157NA	16901	201	74	18016	201
91512-SP0-003.....	18762	570	3156	B3156	206	1176	20585	202	7440	19206	201
91512-SP1-000.....	18762	570	3156A	B3156A	206	12100	17995	201	7443	19207	201
91512-STK-A01.....	22112	NI 17	3157	B3157	206	1255/H3	20600	204	880	20594	204
91512-SX0-003.....	19239	594	3157A	B3157A	206	1260/H4	20601	204	881	20595	203
91513-SJK-003.....	22068	NI 17	3357	B3357	206	1295NA	19208	201	885	20596	204
91513-SP0-003.....	17323	568	3357A	B3357A	206	13050	17994	201	886	20683	203
91514-SP0-003.....	18764	568	3457	B3457	206	1445	18472	201	889	20597	203
91514-SP1-003.....	18760	569	3457A	B3457A	206	1449	18473	201	89	16911	201
91515-SR3-000.....	19483	382	4114K	B4114K	206	158	18014	201	891	20598	204
91526-SP1-003.....	18767	569				161	20285	202	893	20599	204
									90	18015	201

O.E.M. INTERCHANGE BY MANUFACTURER

O.E.M. No.	Auveco No.	Page No.	O.E.M. No.	Auveco No.	Page No.	O.E.M. No.	Auveco No.	Page No.	O.E.M. No.	Auveco No.	Page No.
9003	18661	203	51-41-1-973-500	20253	401	L0001895	B1895	206	34201545	12993	366
9004	16896	203	51-41-700-16-29	21764	NI 14	L0002057	B2057	206	34201621	12567	487
9005	16897	203	51-41-8-172-050	13179	400	L0003057	20722	210	34201631	18108	245
9006	16898	203	51-41-821-58-06	21762	NI 14	L0000357	B3057	206	34201872	19276	536
9007	18662	203	51-41-8-224-768	21788	NI 15	L0003156	B3156	206	34202159	17495	65
904	20291	202	51-43-7-194-187	22109	NI 14	L0003157	B3157	206	34202672	13993	489
906	16922	201	51-44-7-780-135	21499	575	L0003157AK	B3157A	206	3426388	2272	357
912	18008	201	51-45-030-47-03	21764	NI 14	L0003457	B3457	206	3441734	12930	131
916	18006	201	51-45-0-396-330	21763	NI 14	L0007440	B7440	206	3441743	12930	131
916NA	18007	201	51-45-8-161-557	21763	NI 14	L0007440NA	B7440A	206	3454220	15673	548
917	20293	202	51-45-816-52-60	21764	NI 14	L0007443	B7443	206	3454221	15674	548
921	18005	201	51-45-8-266-814	21775	NI 14	L0009004LL	B9004	208	3509575	9905	174
922	20294	202	51-46-7-002-606	21779	NI 16	L0009005	16897	203	3513686	13542	195
93	16926	201	51-47-1-840-961	13172	574	L0009005	B9005	208	3574085	11653	535
97	16912	201	51-47-1-881-521	21851	NI 15	L0009006	16898	203	3588314	13541	195
AVDEL/CHERRY			51-47-1-919-209	22052	NI 16	L0009006	B9006	208	36000148	15666	682
2711-0613	17429	250	51-47-1-945-266	21777	NI 15	L0009006XS	16898	203	36001966	15666	682
2771-0613	17425	250	51-47-2-499-935	21851	NI 15	L0009007QL	18662	203	3671410	12918	132
2771-0817	17427	250	51-47-7-117-532	22090	NI 15	L0009007QL	B9007	208	3673945	12918	132
2771-0824	17428	250	51-47-8-116-564	21851	NI 15	L0009145	BH10	209	3691590	10831	371
2774-0613	17421	250	51-47-8-166-992	21780	NI 16	L000921E	B921	206	3691590	16259	371
2774-0617	17422	250	51-47-8-183-031	21851	NI 15	L00194NA	B194A	206	3693099	14217	497
2774-0817	17423	250	51-48-1-884-779	22052	NI 16	L002057A	B2057A	206	3696693	10843	346
2774-0824	17424	250	51-48-1-915-964	20270	576	L004157NAK	B4157K	206	3744734	10843	346
SSC42	5750	239	51-48-1-938-725	20270	576	L00H355W	20600	204	3744750	12237	174
SSP42	5748	239	51-48-8-181-420	21757	NI 14	MB020923	19385	384	3751212	12923	132
BATCO			51-49-0-151-605	22057	NI 15	MB132008	14335	640	3759944	18770	365
13-3008-L	15004	86	51-49-8-105-79	22057	NI 15	MB153825	17195	632	3764863	12599	195
13-3026-L	15010	86	51-49-8-123-832	22057	NI 15	MB253964	17351	635	3764865	12598	195
13-6003	15017	87	51-71-1-916-199	17646	575	MB325299	16671	680	3767196	18979	345
13-6005	15018	87	51-71-1-958-025	22087	NI 13	MB374270	21118	396	3775994	18770	365
13-8004	15015	86	51-71-7-002-953	20754	245	MB374271	21118	396	3799089	14858	547
BMW			51-71-7-006-757	22140	NI 14	MB547806	17472	647	3843245	12598	195
07-11-9-901-294	13215	68	51-71-7-066-220	22141	NI 14	MB566719	19802	389	3843345	12628	163
07-11-9-901-299	13215	68	51-71-7-066-223	22142	NI 14	MB566720	19334	388	3843386	16349	156
07-11-9-916-945	13215	68	51-71-7-066-226	22092	NI 15	MB608104	19129	398	3843392	12627	163
07-12-9-901-645	13223	67	51-71-7-066-299	22091	NI 15	MB696120	19320	387	3843432	13233	195
07-12-9-901-651	13218	68	51-71-8-184-574	21765	NI 14	MB888869	19140	635	3861577	11347	368
07-12-9-904-150	22114	NI 3	51-71-8-259-788	21781	NI 16	MR200300	20247	594	3861577	11679	367
07-12-9-925-708	13223	67	51-75-7-271-848	22084	NI 14	MS820959	16897	203	4000141	11697	551
07-12-9-925-720	13162	68	51-77-7-171-002	21787	NI 15	MU435004	16254	99	4001916	18508	382
07-12-9-925-737	13218	68	51-77-7-171-003	21776	NI 15	OH452KD5	17080	543	4003120	13004	99
07-13-0-702-966	17267	573	51-77-7-171-004	22147	NI 6	OWX68BD1-AA	20948	543	4003672R	20675	548
07-14-3-448-498	18156	35	52-20-8-238-999	13167	575	OWX68BD5-AA	21021	543	4003673L	14967	548
07-14-6-963-883	22110	NI 2	63-21-7-160-777	BH1	209	TY98TL2-AA	20541	377	4004569	10831	371
07-14-7-122-912	22086	NI 16	63-21-7-160-780	BH7	209	WX68DX9-AA	20739	542	4004569	16259	371
07-14-7-122-913	21854	NI 15	63-21-7-160-806	BD2S	209	06509673AA	21601	545	4005099	11349	400
07-14-7-129-160	22030	NI 2	63-21-7-217-509	BD1S	208	OWX68XDB-AA	21427	543	4005250	11350	376
07-14-7-129-161	22030	NI 2	88-10-0-141-180	B53	206	153297	16478	27	4005470	11678	401
07-14-7-201-307	22084	NI 14	BUDD			154508	16531	29	4005540	11152	348
07-14-7-293-278	22146	NI 6	10708	12522	86	154534	16534	29	4005714	15813	347
07-14-7-391-323	22144	NI 6	10709	12520	86	1560058	19626	691	4006204	11470	463
07-14-7-391-324	22131	NI 6	35337	15004	86	1560058	19627	691	4006316	13965	100
07-14-9-158-194	21762	NI 14	37888	12525	86	1624705	2744	691	4006516	11612	366
16-13-1-176-747	21431	576	37889	12524	86	1624705	12959	691	4006529	15040	369
51-11-1-908-077	20234	576	37891	12523	86	1758099	2752	692	4006848	12943	133
51-11-1-942-789	21861	NI 6	37892	12521	86	1758099	12960	692	4019472	12943	133
51-11-1-944-537	20734	576	95188	15011	86	1900654	9361	357	4023030	4204	339
51-11-7-160-451	21782	NI 14	CHRYSLER (Includes AMC)			1BA41AX1-AA	20763	540	4033711	14552	550
51-11-8-174-185	20248	576	J4004175	9298	82	1BA41XWG-AA	21175	540	4040732	18509	379
51-11-8-400-709	21844	NI 5	J4004354	9297	82	2072728	8746	85	4055028	13542	195
51-12-7-004-445	21777	NI 15	J4004354	10087	82	2074089	8971	722	4095145	12929	131
51-12-7-070-202	22113	NI 3	J4005293	10087	82	2096454	17115	157	4100727	12932	133
51-13-1-829-904	13158	574	J4006956	18163	85	2096466	14892	157	4104998	12937	131
51-13-1-885-399	16115	576	L0000067	B67	206	2096467	15504	157	4114785	12134	358
51-13-1-960-054	21429	575	L0000089	B89	206	2409826	8742	85	4124721	12598	195
51-13-2-251-394	21430	575	L0000168	20706	210	2448770	16873	703	4167810	12920	132
51-13-6-440-146	21767	NI 13	L0000168	B168	206	2486468	17434	550	4179981	12946	132
51-13-8-124-389	20254	575	L0000194	B194	206	2496279	9905	174	4179982	12944	133
51-13-8-166-675	21432	575	L0000880	B880	207	2524525	8419	535	4198993	16729	549
51-13-8-231-130	21766	NI 13	L0000886	B886	207	2534814	14461	722	4201198	12934	132
51-14-1-807-495	20186	575	L0000891	B891	207	2664040	14985	379	4241054	12939	133
51-14-1-902-279	20186	575	L0000894	B894	208	2745108	20675	548	4241296	12930	131
51-16-1-881-149	20187	628	L0000896	B896	208	2945108R	20675	548	4241362	12916	132
51-18-1-821-830	18156	35	L0000899	B899	208	2945109	14967	548	4275973	13465	547
51-21-6-442-159	13167	575	L0000906	B906	206	2945109L	14967	548	4304729	16804	156
51-21-8-205-295	20388	576	L0000912	B912	206	2964547	11129	365	4307218	12943	133
51-32-1-938-884	21423	574	L0000912	B912	206	2998430	10332	373	4336115	17167	550
51-41-015-44-20	21764	NI 14	L0000H11	BH11	209	3236813	12927	133	4339372	21022	350
51-41-0-407-984	21788	NI 15	L0000H13	BH13	209	3237451	12949	133	4341060	17004	378
51-41-1-802-258	13170	67	L0001156	B1156	206	3239826	12935	131	4368618	15499	154
			L0001157	B1157	206	34201287	16826	36	4370138	17101	246
			L0001893	B1893	206	34201358	15331	64	4381395	20316	374

O.E.M. INTERCHANGE BY MANUFACTURER

O.E.M. No.	Auveco No.	Page No.	O.E.M. No.	Auveco No.	Page No.	O.E.M. No.	Auveco No.	Page No.	O.E.M. No.	Auveco No.	Page No.
4389940-AB	21670	540	55176248	14020	526	6031438	12996	97	6501878	17104	542
4389947-AA	21376	546	55256967-AC	19816	345	6031869	12713	468	6501916	15543	372
4400588	13542	195	55350747-AB	19775	399	6031875	19152	548	6501925	18030	489
4428987	19155	378	56001419	15666	682	6032061	12566	468	6501948	19893	368
4437565	12237	174	5BB14LX9	19245	545	6032083	16851	82	6502081	16871	703
4486948	11157	175	5FR56DX9	19894	539	6032138	16687	255	6502083	16872	703
4498100	14552	550	5FR56XX-AB	19894	539	6032363	11351	373	6502085	16873	703
45998051	12119	66	5GC71RC3-AA	20273	524	6032516	13466	38	6502087	16874	703
4630088	18031	245	5GF92RC3-AA	20273	524	6032856	17615	254	6502089	16875	703
4630088	18028	245	6000258	19537	100	6032926	12655	252	6502089	16876	703
4630253	18029	541	6000558	10073	100	6032926	14486	252	6502090	16877	703
4630660	18031	245	6000605	5854	100	6033082	17664	371	6502091	16878	703
4636359	18919	195	6000705	2619	692	6033560	15345	82	6502104	18771	374
4636360	18921	195	6000705	12958	692	6033677	14756	513	6502152	16846	108
4636361	18920	195	6000720	2752	692	6033688	18810	260	6502328	14921	365
4636362	18920	195	6000720	12960	692	6033840	17664	371	6502381	18815	367
4638136	14753	485	6000943	8419	535	6033862	11349	400	6502450	16876	703
4638136	14993	486	6000943	8719	719	6034213	10375	82	6502491	16870	703
4658444	19191	548	6000943	9377	535	6034336	19310	549	6502545	18237	547
4658673	19149	366	6002893	10622	349	6034376	18373	223	6502573	18032	541
4658676	20675	548	6003147	11354	539	6034703	18934	32	6502625	16835	486
4658677	14967	548	6003219	13616	538	6034812	19310	549	6502689	18501	245
4658887	20165	365	6003220	8853	380	6034848	19657	254	6502738	17353	85
4676356	19339	549	6003349	11678	401	6034944	16988	247	6502745	16868	703
4696129	18033	381	6003351	11136	382	6035094	2562	82	6502776	18102	529
4696488	14995	485	6003409	20276	349	6035188	18934	32	6502842	17975	378
4717224	19855	370	6003423	11673	373	6035201	17639	261	6502871	14992	522
4759514-AB	20356	538	6003587	11675	367	6035201	19263	261	6502907	17669	397
4784018-AA	21231	537	6003609	12794	538	6035274	14037	468	6502988	19519	499
4805336-AA	19642	537	6003632	11936	539	6035401	20179	536	6502991	17685	399
4805405-AA	19638	546	6003752	20276	349	6035414	19406	254	6503106	18269	545
4805405-AB	19638	546	6003774	13927	538	6035417	18373	223	6503108	18034	536
4805570-AA	20526	549	6003858	13847	539	6035807	19310	549	6503163	14997	485
4806110-AA	20767	545	6003861	13843	538	6035821	20524	537	6503204	18862	398
4806226-AA	21187	498	6003873	13845	539	6036148-AA	20629	256	6503221	12766	374
4806240-AA	20768	544	6003878	20276	349	6036310-AA	18163	85	6503336	21023	403
4806240-AB	20768	544	6003965	13927	538	6036747-AA	18163	85	6503339	18249	547
4806271-AA	22028	NI 12	6004036	17151	539	6100042	11629	109	6503373	18825	537
4806334-AA	20963	546	6004162	17064	539	6100047	19216	64	6503401	19417	61
4857345-AA	20457	545	6004212	14005	245	6100048	15329	64	6503433	18375	225
4857699-AA	20771	541	6006264	3404	83	6100049	15331	64	6503453	18394	546
4857751-AA	20769	537	6010029	19626	691	6100050	15333	64	6503454	18327	543
4860375-AB	20667	537	6010029	19627	691	6100539	12232	51	6503598	17216	491
4860379-AA	21026	371	6010046	2752	692	6100567	19455	52	6503709	19213	389
4878883-AA	20164	378	6010046	12960	692	6100568	15818	52	6503768	18301	370
5008055-AA	20309	352	6010093	2744	691	6100775	12254	66	6503800	13748	245
5010366-AA	19791	553	6010093	12959	691	6100810	12115	66	6503812	19779	549
5012874-AA	19628	398	6013029	2619	692	6100811	12253	66	6503819	19417	61
5023111-AA	19804	400	6013029	12958	692	6100814	19548	66	6503837	18531	81
5023173-AA	20563	399	6013122	11677	402	6100815	16829	66	6503860	17101	246
5023351-AA	19804	400	6023171	10053	106	6100839	12122	66	6503892	18827	377
5028438-AA	20428	398	6023204	15345	82	6100840	12123	66	6503938	18913	245
5073327-AA	20187	628	6023718	18811	239	6101283	11629	109	6503943	20189	372
5102247-AA	20861	553	6023925	8242	39	6101308	18449	108	6504014	17669	397
5103921-AA	20637	629	6025004	15345	82	6104900-AA	21086	629	6504014	18915	397
5113015-AA	18032	541	6025005	15347	82	6104908-AA	18302	365	6504018	19141	225
5116530-AA	20966	544	6025007	15350	82	645350	1256	357	6504043	17612	371
5116530-AA	20990	490	6025329	9480	21	6500092	12617	85	6504072	19793	536
5134937-AA	20861	553	6026166	16237	99	6500284	15329	64	6504090	12567	487
5159077-AA	20964	538	6026430	9299	82	6500361	14561	550	6504098	19338	376
5159077-AB	20964	538	6026723	10655	18	6500526	12715	85	6504135	19541	373
5160260-AA	20966	544	6026723	10656	18	6500650	15860	703	6504424	18375	225
5189180-AA	21154	539	6026723	10657	18	6500651	15861	703	6504452	17669	397
5189181-AA	21155	541	6026958	10086	82	6500722	15862	703	6504521	19422	544
5208743	15040	369	6027924	10080	548	6500787	14016	488	6504555	17222	488
5255110	18979	345	6027958	19485	39	6500859	13754	245	6504601	19779	549
53041045	16873	703	6029348	16852	82	6500898	13755	245	6504700	13750	246
55022134	15042	493	6029501	12735	466	6500911	13750	246	6504870-AA	19809	105
55054844	15666	682	6030441	11146	371	6501025	12125	66	6505149-AA	18531	81
55055098	18248	382	6030441	15414	371	6501067	15481	373	6505161-AA	19640	536
55075139	17214	485	6030441	18815	367	6501086	20316	374	6505292-AA	19386	397
55156429-AA	20523	539	6030538	10832	371	6501220	19718	60	6505411-AA	10831	371
55156447-AB	20700	540	6031091	11621	252	6501301	16818	369	6505417-AA	19836	366
55156655-AA	21738	NI12	6031091	16838	252	6501415	16980	66	6505534-AA	20829	389
55156879-AB	20962	538	6031115	11620	251	6501509	18242	245	6505539-AA	19628	398
55157055-AA	20700	540	6031115	16837	251	6501559	13751	246	6505667-AA	20360	372
55157055-AA	20887	541	6031147	8865	82	6501577	17106	488	6505703-AA	20267	536
55157065-AA	20887	541	6031183	14218	536	6501590	14019	526	6505759-AA	20427	399
55157069-AB	20827	540	6031234	13647	536	6501630	17104	542	6505813-AA	18934	32
55157070-AC	20828	539	6031321	10831	371	6501699	17354	537	6505863-AA	20420	547
55157112-AA	20890	546	6031383	11704	542	6501772	17104	542	6505878-AA	17124	389
55157112-AB	20890	546	6031390	11699	487	6501773	12569	514	6505918-AA	20515	397
55157330-AC	20940	546	6031438	12995	97	6501825	12259	66	6506007-AA	13751	246

O.E.M. INTERCHANGE BY MANUFACTURER

O.E.M. No.	Auveco No.	Page No.	O.E.M. No.	Auveco No.	Page No.	O.E.M. No.	Auveco No.	Page No.	O.E.M. No.	Auveco No.	Page No.
6506008-AA	19639	489	FIAT			D7VY-6050074-A	13966	100	E9DZ-6730-B	19773	225
6506104-AA	20173	549	14591787	21802	NI 34	D8BB-14474-BA	14889	156	E9DZ-6734B	18299	222
6506132-AA	20458	545	14592086	21804	NI 34	D8BZ-13466-A	16922	201	E9FZ-5822008-A	18890	532
6506161-AA	19278	59	14592087	21803	NI 34	D8BZ-13466-A	18906	206	E9SB-13N019-BA	16425	513
6506214-AA	19141	225	4-131-508-M	13230	628	D8BZ-14474-A	14889	156	E9SB-6302354ACW	15523	373
6506306-AA	20623	547	4-29-29-06	13198	368	D8BZ-5423342-A	13030	534	E9SZ-13N019-B	16425	513
6506807-AA	21035	548	FORD			D8TZ-13466-A	18472	201	E9SZ-13N021-A	16898	203
6506852-AA	20468	537	A20Z-13410B	13537	184	D8TZ-6730-A	19365	227	E9SZ-13N021-B	16897	203
6506852-AB	20468	537	AB-181-GG	16893	52	D90Z-6522841A	14551	533	E9TZ-13032B	16399	511
6507055-AA	20765	398	B100-68-675-69	21119	439	D9AB-74519B18-AA	14758	402	E9TZ-6730-B	19365	227
6507669-AA	20766	545	B5A-10756-B	8964	722	D9AE-9E645-AA	12921	132	E0SZ-13466-A	20291	202
6507686-AA	20765	398	B5AZ-13466-A	B89	206	D9AZ-14474-F	16344	156	E0VY-13A506-A	17164	528
6507741-AA	21354	224	B7A-16758-A	4273	339	D9AZ-14A163-J	12622	528	F03Z-13032-A	16733	511
6508072-AA	21236	535	B8AZ-13466-A	16919	201	D9ZZ-6643030-AA	19594	533	F0TZ-14489-J	19004	193
6508197-AA	21098	523	BC3Z-6730-A	21665	223	DG9Z-14526-N	21749	NI 3	F1CZ-13466-C	20595	203
6508365-AA	20623	547	C0AZ-1012-A	8744	85	DG9Z-14526-P	21751	NI 3	F1CZ-13A147-A	18899	512
6508444-AA	21446	245	C1AB-6220807-A	3639	382	DG9Z-14526-R	21752	NI 3	F1CZ-16774-A	18458	385
6508540-AA	21418	253	C1SF-14474-A	15504	157	DG9Z-14526-S	21750	NI 3	F1CZ-5802316-A	19138	619
6508643-AA	21348	546	C2AZ-13466-C	16902	201	E0TB-1063-226AC	16213	461	F1CZ-61101B04-A	17602	521
6508712-AA	20888	490	C2AZ-13466-C	B194	206	E0VE9K319AB	12938	132	F1CZ-8A188-A	17317	516
6508727-AA	21257	372	C2TB-14462-A	17115	157	E1EB-61046A48-BA	12606	530	F1TZ-17698-A	19393	520
6508746-AA	14010	487	C3AZ-13466-D	20285	202	E1EZ-9E499-EA	18835	132	F1TZ-7810182-A	19441	352
6508863-AA	20988	489	C3DZ-13466-A	16904	201	E1ZE-9E499-CA	18836	133	F1ZZ-13466-A	20286	202
6508947-AA	21153	540	C3DZ-13466-A	B1156	206	E1ZE-9E499-EA	18835	132	F22Z-16774-A	14709	367
6509049-AA	20880	490	C5AB-14474-B	14892	157	E25Y-14421-C	16342	156	F2DZ-13466-C	20599	204
6509103-AA	19801	489	C5AB-6220586-A	8853	380	E25Y-14421-CA	16342	156	F2PZ-14A464-C	19004	193
6509106-AA	21019	549	C5AZ-6243720-B	4750	337	E2EB-6120C62-AA	19154	517	F2UZ-1602354-AAA	19846	375
6509288-AA	21223	540	C5ZZ-6543413-B	8941	349	E2EB-61290C62-AA	19154	517	F32Z-17C756-S	17003	625
6509539-AA	21865	NI 2	C60Z-16758-A	4357	339	E2GZ-6723342-A	13030	534	F37Z-13N129-A	18263	513
6509590-AA	21679	NI 12	C6AB-6242413-A	9353	349	E35Y-13466-A	20294	202	F3DZ-6730-A	18025	225
6509960-AA	21680	NI 13	C7SZ-13466-B	16921	201	E35Y-13466-B	18012	201	F3DZ-6734-A	18299	222
68004187-AA	21187	498	C7SZ-13466-B	20706	210	E3MY-13466-A	18006	201	F3LY-14570-B	17222	488
68009867-AA	21105	386	C7SZ-13466-B	B168	206	E3MY-13466-A	20291	202	F3LY-6321970-A	17119	531
68033794-AA	21442	547	C80Z-13711A	12237	174	E3MY-13466-A	20711	210	F3LY-6321971-A	17118	531
68034329-AA	21442	547	C8AB-14463-M	18451	157	E3SB-6342413-AB	13564	349	F4CZ-13466-A	16917	201
68039280-AA	21528	541	C8AZ-63442413-A	9882	349	E3TB-1063-226AA	16213	461	F4CZ-13466-A	B3157	206
68061648-AA	21329	395	C8AZ-63642413-A	9882	349	E3VB14461AA	18853	156	F4PZ-14A411-C	19885	193
68084593-AA	21213	537	C8TZ-13466-A	16899	201	E3VB-144861-AA	18853	156	F4TZ-13N021-B	18662	203
68092697-AA	20870	540	C8TZ-13466-A	B1157	206	E4FZ-8C290-A	17619	190	F4TZ-13N021-B	B9007	208
68213168-AA	21791	NI 12	D0AZ-62234A24-B	17974	353	E5AZ-13466-A	18476	201	F4UB-14A464-A	19004	193
68225214-AA	21835	NI 12	D0DZ-15A434-B	9883	174	E5LY-13N021-A	16896	203	F4VY-14A411-S	20846	192
7368261	16801	156	D0DZ-13A-093AA	11660	512	E5LY-13N021-A	B9004	208	F4XY-6734-A	21258	222
7703-077-066	12993	366	D1AB-14461-AA	14887	156	E5ZZ-12A209-A	18217	188	F5Z2-6310182-A	20965	520
812893	12600	176	D1AB-6542413-AB	9882	349	E6AZ-5421952-A	15675	532	F50Y-14603-A	21224	515
83501000	12599	195	D1AZ-13410-A	19813	192	E6DZ-13032-A	15968	511	F54Y-13466-A	19209	204
83504041	19318	223	D1AZ-13410B	13537	184	E6DZ-13466-B	18005	201	F54Y-13466-A	20717	211
8880417	15672	542	D1AZ-6522841A	14550	509	E6DZ-13466-B	B916A	206	F57B-16241-AA	21000	520
8934-201-235	13464	650	D1AZ-6542413-B	9882	349	E6DZ-13K040-B	15634	512	F57Z-16241-AA	20663	520
8934-201-262	11855	466	D1FZ-13234-A	14135	185	E6DZ-14A411-A	18676	188	F57Z-7810182-AAA	19441	520
8934-201-263	9377	535	D1FZ-13466-B	16913	201	E6DZ-5421952A	17122	532	F58Z-16237A02-A	18848	389
8934201287	16826	36	D1FZ-6222600-A	12470	534	E6DZ-5421970-A	17119	531	F5DZ-13466-B	17996	201
8934-201-493	16256	99	D2AZ-6522008-A	18892	533	E6DZ-5421971-A	17118	531	F5DZ-13466-B	B3156	206
8934-201-602	12713	468	D2FZ-6222600-A	12470	534	E6FZ-13466-B	18016	201	F5DZ-17K657-A	20425	514
8934-201-681	13475	400	D20B-13A093-AA	11660	512	E7EB-14421-EA	16342	156	F5RZ-5421416-B	19281	513
8934-201-767	13966	100	D20B-13A093-AA	11661	512	E7EB-14461-BA	20475	156	F5RZ-6730-B	18374	224
8934-201-835	17496	246	D20B-14421-BB	20815	156	E7EB-14474-CA	16344	156	F5TZ-6734-BA	20453	222
8934-202-293	16251	99	D3AA-90826-AA	10837	529	E7GZ-17A904-B	15366	623	F65Z-15020C34-AA	19536	529
8934-202-599	17102	390	D3AB-14474-DA	14889	156	E7GZ-6120586-B	18692	381	F65Z-15020X34-AA	19536	529
8936000	15666	682	D3AZ-13410-A	13535	184	E7SB-13A093BA	15966	511	F67Z-7822008-AA	18890	532
8936001	15666	682	D3AZ-13410-B	13533	184	E7SZ-13032-D	15966	511	F6DZ-5402316-AA	19238	516
8956001	15666	682	D3AZ-13410-E	14131	185	E7ZZ-13466-B	18007	201	F6DZ-5403296-A	20942	345
9411943	3401	83	D3AZ-13410-G	14132	185	E804-14526A	15926	171	F6DZ-5410182-AA	20358	520
9422202	13708	27	D3AZ-14474-G	20816	156	E804-14526B	15927	171	F6TZ-6730-BA	19279	225
9422246	13707	26	D3AZ-14526-D	12629	163	E804-14526D	15931	171	F75Z-6730-BA	18025	225
9423950	15827	30	D3AZ-14526-D	15372	163	E83B-13A093-AA	16733	511	F75Z-6730-BA	19773	225
9427977	13709	30	D3AZ-14526-E	12628	163	E83Z-16758-A	16832	340	F79Z-1123342-AAA	13030	534
9428273	13027	30	D3AZ-14526-H	12628	163	E83Z-5421952-B	17122	532	F7CZ-17C756-BA	20336	515
972724	4244	339	D3AZ-14526-J	12629	163	E8AZ-13466-A	17996	201	F7DZ-5402316-AA	19238	516
CREATIVE			D3AZ-14526-Z	12627	163	E8BZ-17C756-C	17450	623	F7UZ-1513284-BA	19421	530
BSS800	12654	260	D30Z-16776-A	11136	382	E8EB-13A093AA	16396	511	F7UZ-15238A32-AAC	19413	521
DAYTON			D42B-6021066-BA	14213	518	E8EB-13A093AB	16396	511	F81Z-19D887-AA	20843	190
5715	15017	87	D4AZ-13466-A	18465	201	E8EB-13A093BA	16397	512	F81Z-6730-AA	20807	223
5716	15015	86	D4LY-13410-A	14133	184	E8EB-14474-VA	16348	156	F8DZ-54265A99-AA	20630	532
8411	15018	87	D4MY-13466-A	18011	201	E8FZ-13032-A	16396	511	FD1A13021-A	12228	512
EUCLID			D4OZ-13234-A	14128	185	E8FZ-13032-B	16397	512	K8A0-51PR6	18882	616
4956-A	15017	87	D4ZZ-13234-A	14130	185	E8FZ-5802354-A	19845	375	MB455-56143	17632	523
4963	15015	86	D5AB-14474-FA	20816	156	E92Z-17C756-C	17060	623	N605774-S2	12338	52
5706	15018	87	D5ZZ-16828A	17338	529	E97B-13A093BA	16399	511	N605920-S2	12327	54
5735-L	15004	86	D6EA-1A100-AA	11702	414	E97B-13A093BB	16399	511	N606676-S100	12160	51
5988-L	15010	86	D6TZ-6730-A	14196	223	E97B-13A093BB	16399	511	N606676-S100	15778	51
5988-R	15009	86	D7TZ-13466-A	18008	201	E9AZ-5422008-A	18891	532	N606676-S2	12160	51
			D7TZ-13466-A	20710	210	E9DB-13N020AA	15940	512	N606676-S36	15778	51
			D7TZ-13466-A	B912	206	E9DZ-13N129-A	1594				

O.E.M. INTERCHANGE BY MANUFACTURER

O.E.M. No.	Auveco No.	Page No.	O.E.M. No.	Auveco No.	Page No.	O.E.M. No.	Auveco No.	Page No.	O.E.M. No.	Auveco No.	Page No.
N606677-S53B	15779	52	N804193-S100	18167	252	N811169-S	19783	517	W707388-S300	20936	521
N606690-S2	15780	53	N804343-S	13748	245	N811257-S100	20421	530	W707606-S300	20517	515
N606690-S55	15780	53	N804344-S	14967	548	N811257-S309	20421	530	W707638-S900C	22067	NI 5
N606692-S2	16931	53	N804349-S	15479	375	N811259-S	18812	239	W707889-S300	20192	370
N610959-S2	13019	61	N804379-S	15478	374	N811283-S	20545	523	W708035-S300	20531	369
N620391-S36	17495	65	N804448	14757	368	N811353-S100	20171	516	W708045-S300	20532	515
N620480	15316	64	N804570-S	14753	485	N811460-S100	19419	255	W708088-S300	18770	365
N620480-S2A	15316	64	N804570-S	14993	486	N811478-S100	20927	39	W708319-S300	21239	515
N620482	15318	64	N804583-S	15187	245	N811534-S61	19653	60	W708325-S300	14998	486
N621900	15325	64	N804614-S	13994	492	N811540-S	20360	372	W708384-S309	20401	531
N621903	15326	64	N804674-S	15701	526	N811772-S	19472	495	W708456-S309	16883	64
N621905	15328	64	N804675-S	17101	246	N905150-S	17466	259	W708513-S309	20776	531
N621906-S361	16774	64	N804759-S	15491	246	NA01-56145	16858	646	W708530-S300	20632	491
N621906-S437	16774	64	N804765-S	19277	514	W520821-S426	18338	107	W708580-S300	21362	514
N621907	15332	64	N804837-S	14994	524	W520821-S439	18338	107	W708621-S300	20190	398
N621940-S424	15335	64	N804851-S100	19516	261	W520822-S426	12669	108	W708633-S300	21313	376
N621942-S301	15337	64	N804992-S58	10654	4	W520823-S426	11629	109	W708761SSB	18275	375
N621942-S441	15337	64	N805026S	14995	485	W520823-S439	11629	109	W708761-SB	15480	373
N621945-S2	21001	64	N805083-C	16832	340	W520832-S424	12575	108	W708771S300	20530	516
N623330-S2	18337	107	N805155-S	17124	389	W520832-S426	12575	108	W708777-S437	22023	NI 5
N623331-S2	18338	107	N805229-S	14988	522	W525170-S	19462	251	W708777-S900C	21286	260
N623332-S21	12669	108	N805231S	15522	524	W525170-S417	19414	251	W709002-SAA	20624	369
N623332-S439	12669	108	N805315	17381	376	W525172-S300	19110	251	W709176-S300	19639	489
N623332-S53	12669	108	N805350-S	20675	548	W525172-S417	19461	251	W709629-S300	20532	515
N623333-S100	11629	109	N805592-S100	17121	257	W525174-S	19420	252	W709688-S300	21790	NI 11
N623333-S2	11629	109	N805612-S	17102	390	W525174-S300	19420	252	W709767-S300	20663	520
N623340-S2	11625	107	N805612-S100	17102	390	W525175-S300	19456	252	W709984-S300	20631	490
N623343-S100	11630	109	N805759-S100	16834	255	W700566-S300	18383	514	W709995-S300	21247	397
N623343-S2	11630	109	N805889-S100	19480	108	W700614-S300	18498	520	W710079-S300	21373	259
N623344-S2	18339	109	N805995-S100	18331	261	W700671-S300	20319	372	W710250-S300	21089	523
N800312-S2	15776	60	N806113-S	20189	372	W701054-S300	18503	527	W710312-S300	20761	370
N800369	16422	35	N806126-S100	17408	253	W701133-S300	18386	528	W710459-S300	20466	468
N800369-S2	16421	35	N806289-S	17339	381	W701223-S300	20194	521	W710528-S300	20817	518
N800387-S	11842	376	N806322-S	18893	523	W701259-S300	10831	371	W710532-S300	20926	370
N800466	15325	64	N806334-S	20245	513	W701374-S	20399	367	W710754-S439	21187	498
N800484-S58	16736	1	N806340-S	19850	380	W701380-S5W	18379	369	W710791-S437	21215	531
N800503-S	11841	515	N806344-S	18275	375	W701430-S300	18377	518	W710793-S439	21185	512
N800510-S100	20176	51	N806363-S	20264	515	W701566-S417	18331	261	W710923-S300	18680	374
N800540-S100	20176	51	N806511-32	19823	530	W701649-S	19237	30	W711031-S300	21826	NI 11
N800854-S2	18449	108	N806511-S32	19823	530	W701855-S300	20366	370	W711037-S300	20949	398
N800947-S	16893	52	N806511-S441	19823	530	W701971-S	20169	527	W711079-S300	21368	514
N801117-S100	18401	109	N806624-S191	18102	529	W701971-S	20169	527	W711521-S300	20616	399
N801169-S900	22104	NI 1	N806830-S100	17639	261	W701993-S	17604	331	W711687-S300	21199	367
N801310	15317	64	N806830-S100	19263	261	W702010-S300	19532	379	W711858-S300	21334	380
N801603-S2	20271	59	N806959-S	19235	331	W702380-S300	18504	529	W712160-S300	21165	515
N801706-S	12569	514	N807154-S	19371	371	W702412-S300	19345	521	W712196-S300	20889	491
N801925-S	12565	389	N807154-S	19373	371	W702512-S900C	22023	NI 5	W712665-S300	20993	492
N801994-S100	19667	368	N807155-S	19352	370	W702554-S900C	22066	NI 5	W713202-S300	21172	522
N802239-S	17643	528	N807155-S	19354	370	W702926-S	18744	244	W713297-S300	21169	399
N802241-S	17642	528	N807168-S	19111	259	W703842-S300	20193	521	W713331-S300	20989	490
N802331-S53	16842	108	N807189-S100	20171	516	W703919-S300	20193	521	W713445-S300	21172	522
N802376-S	14754	514	N807247-S	19526	517	W704340-S300	14020	526	W713579-S300	21794	NI 12
N802538-S100	14526	104	N807389-S	17216	491	W704881-S300	19237	30	W713590-S300	21174	519
N802734-S	15480	373	N807535-S	19760	372	W704958-S300	19511	527	W713610-S300	20988	489
N802734-S	19197	373	N807577-S	18895	523	W705002-S300	19338	376	W713819-S300	21864	NI 4
N802737-S	13469	524	N807578-S	18894	523	W705297-S300	21245	260	W714040-S300	20880	490
N802775-S36	16883	64	N807620-S100	18461	255	W705376-S900	17420	250	W714599-S300	17420	250
N802781-S	14020	526	N807673-S	22058	NI 12	W705436-S300	19801	489	W714975-S300	20992	491
N802900-S	12565	389	N807706-S	19326	514	W705532-S300	16726	525	W715201-S300	21668	519
N802900-S	13470	389	N807721-S	17612	371	W705550-S300	19783	517	W715537-S300	20826	490
N803043-S	13750	246	N807875-S	19524	403	W705589-S	11146	371	W715926-S300	21673	368
N803170-S	14021	365	N807943-S	19810	389	W705589-S	15414	371	W715951-S300	22053	NI 12
N803183-S32	14814	102	N807951-S	18820	368	W705589-S300	11146	371	W716351-S300	22099	NI 11
N803362-S	13993	489	N807994-S	18816	517	W705590-S300	20466	468	W716352-S300	22124	NI 11
N803387-S	15668	377	N808041-S437	20742	500	W705711-S417	19414	251	W716460-S300	21187	498
N803387-S300	15668	377	N808048-S	16726	525	W705845-S300	17632	523	W716460-S300	22038	NI 11
N803421-S	14019	526	N808147-S	14991	485	W705848-S300	14753	485	W716497-S300	21669	518
N803494-S	14953	522	N808182-S309	19436	531	W705849-S300	20355	521	W716503-S300	22033	NI 11
N803613-S	16863	377	N808182-S439	19436	531	W705955-S300	20177	370	W716510-S300	21703	NI 12
N803638-S36B	14895	530	N808331-S	18895	523	W705956-S300	20233	524	W717736-S300	22154	NI 20
N803685-S11	14820	500	N808332-S	18894	523	W705957-S300	20518	527	W790173-S900	21202	518
N803709-S	17103	488	N808342-S307	20546	530	W706092-S300	21098	523	W790225-S900	22021	NI 9
N803716-S	14018	526	N808370-S	19127	372	W706172-S309	20401	531	XL3Z-17E971-AA	19607	524
N803734-S	15480	373	N808594-S100	18396	252	W706182-S300	20516	525	XW1Z-5822008-AA	18891	532
N803739-S	22139	NI 6	N808689-S417	19458	253	W706350-S300	14992	522	XW7Z-6302354-AAB	20625	375
N803763-S100	20415	501	N808791	20273	524	W706358-S300	15478	374	YF4Z-8194-AA	20400	517
N803768-S	18155	513	N808842-S	19338	376	W706494-S300	19849	524	YL3Z-1521970-AA	20153	531
N803857-S	20311	366	N808847-S	19244	526	W706519-S300	20518	527	YL3Z-1521970-AB	20153	531
N803862-S	13751	246	N808908-S	19337	527	W706575-S300	20393	514	YL3Z-1521971-AA	20195	531
N803933-S101	17408	253	N811006-S	18936	402	W706635-SSW	21241	375	YL3Z-1521971-AB	20195	531
N803946-S	14992	522	N811018-S100	17639	261	W706713-S300	20367	523	YR3Z-13466-AD	B3157A	206
N803968-S100	14819	530	N811018-S100	19263	261	W706815-S300	21257	372	YR3Z-13466-AD	B4157	206
N804189-S	13747	245	N811040-S	20893	366	W707157-S300	20245	513	YS4Z-13N021-AA	18661	203

O.E.M. INTERCHANGE BY MANUFACTURER

O.E.M. No.	Auveco No.	Page No.	O.E.M. No.	Auveco No.	Page No.	O.E.M. No.	Auveco No.	Page No.	O.E.M. No.	Auveco No.	Page No.
YS4Z-13N021-AA	20601	204	383033-S100	11863	357	45262	10048	106	10108746	16625	491
YS4Z-16K262-AA	20191	523	383033-S101	10780	357	45262	18898	106	10109689	15490	246
YS4Z-6730-AA	20347	224	383033-S101	11863	357	45263-S101	10050	106	10119816	18859	370
YS4Z-6734-AA	21180	222	383142-S	20310	524	45263-S2	10050	106	10119853	17128	469
YU5Z-13466-AD	16901	201	383207-S	14217	497	45264	10053	106	10121502	17664	371
YU5Z-13466-AD	B3457A	206	383229-S	11104	253	45264-S2	12265	106	10125439	16864	256
1008068	21853	NI 32	383229-S	11105	253	45265-S2	10054	107	10126901	15669	401
13235-A	8763	197	383229-S	11106	253	45267	10051	106	10129981	15811	65
16758	4248	338	383255-S36	16770	82	45268-S2	8814	107	10131511	18461	255
16758A	4155	339	383356-S	14756	513	45268-S2	10052	107	10134407	18030	489
17562	4260	338	383847-S	11419	133	45269	10055	107	10135796	18118	471
1F1Z-19E889-AA	19235	331	384111-S	12949	133	45332	15347	82	10139822	14991	485
1L5Z-17K826-AA	19638	546	384432-S	19459	256	45334	15345	82	10140480	16835	486
1R3Z-18D434-BA	21445	529	384931-S36	17035	22	4F1Z-9A317-AA	21214	529	10143422	17102	390
1U2Z-14S411-AEA	20843	190	385189-S100	11620	251	4L3Z-1503296-AB	20836	345	10153057	16695	392
1U2Z-14S411-AJA	18671	192	385189-S100	16837	251	4L3Z-1510182-AA	20862	518	10157547	16939	260
1U2Z-14S411-BPA	20842	191	385323-S100	11621	252	55914-S2	13021	31	10157900	16622	490
1U2Z-14S411-TA	20851	194	385323-S100	16838	252	56910-S2	13025	27	10158124	18175	390
1U2Z-14S411-YA	21490	178	385330-S	11136	382	56910-S424	13025	27	10160960	18935	259
1U5Z-13466-BB	16901	201	385353-S	12210	341	56911-S2	13711	28	10167445	19357	475
1W1Z-19E889-HB	17604	331	385400	15345	82	56911-S36	13711	28	10167448	18428	474
1W6Z-238A90-AA	20363	527	385661-S	11351	373	56911-S61	13711	28	1016937	12669	108
2C5Z-13N021-AA	BH11	209	385677	19425	380	56912-S	13026	28	10169777	20344	365
2F1Z-9A317-AA	20482	528	385974-S	19460	258	56929-S2	13711	28	10184895	13751	246
2F1Z-9A317-BA	20483	528	386299-S	16954	529	57030-S36	17034	21	10185925	18301	370
352839	4258	338	386553-S	19655	378	5C3Z-13466-AA	18016	201	10186453	18691	495
353123	1256	357	387042-S	12939	133	5C3Z-13466-AA	18465	201	10195515	14995	485
353745-S	2598	125	387065-S	12932	133	5C3Z-13N021-AA	BH13	209	10201332	19514	256
354341-S	5196	100	387074-S	12933	133	5F7Z-13466-B	20285	202	10204266	18170	261
354860-S	4248	338	387182-S	11671	390	5R3Z-54310D12-AAA	21024	525	10207146	17226	426
357811	4246	338	387258-S	11679	367	5R3Z-54310D12-BAA	21560	368	10220168	18688	374
358107	2272	357	387466-S	12209	341	5U2Z-14S411-ZB	20842	191	10229437	18680	374
358470	9361	357	387477-S	11797	391	6E5Z-13466-AC	B4157K	206	10237960	19220	500
358560	19626	691	387496-S	11672	401	6E5Z-7850980-AAA	21024	525	10241518	18688	374
358560	19627	691	387843-S	11705	524	6G1Z-5410182-A	20977	520	10242285	20521	479
370247-S2N	5586	105	387944-S	11706	524	6G1Z-5410182-C	20979	518	10242316	18680	374
370374-S	4248	338	387980-S	12948	133	6W1Z-5422008-A	18890	532	10246149	19788	485
372741-S100	9864	215	388034	12919	132	7L3Z-9S317-A	21126	529	10249241	19501	374
372820-S36	12654	260	388047-S100	11852	251	7L3Z-9S317-B	21127	528	10261327	19410	470
372820-S40	12654	260	388047-S102	12653	251	800843	12935	131	10262036	18684	365
373528-S32	5854	100	388047-S1021	11852	251	801471	12922	132	10262143	19247	467
373846-S	12918	132	388047-S1021	12653	251	803716-S	14018	526	10270517	20464	481
375203-S	17467	254	388131-S	12925	132	91GBA611A08EAW	18387	529	10270672	19390	476
375372-S	5592	383	388246-S	11612	366	9L3Z-14030A12-A	20836	345	10274778	19819	351
375480-S100	5195	100	388248-S-36B	11768	102	9N7Z-13N021-A	16897	203	10277480	19676	467
375480-S102	5195	100	388442-S100	12652	261	9N7Z-13N021-A	16898	203	10278936	17654	247
375890-S102	11293	100	388442-S309	12652	261	9N7Z-13N021-A	B9005	208	10281487	20395	501
375936-S	17469	253	388577-S	11146	371	FREIGHTLINER					
376337-S100	9853	18	388577-S	15414	371	22-44567-000	19844	561	10285935	19270	392
376337-S100	9854	18	388664-S100	14127	258	GENERAL MOTORS					
376337-S100	9855	18	388904-S	20316	374	05480853	8889	239	10287379	20261	52
376785-S2	15351	82	388908-S	14163	378	10003294	12919	132	10287547	20408	476
376988-S2	10654	4	388908-S	19655	378	10003617	12927	133	10287926	20232	472
377537-S	16039	6	388916-S	12908	341	10004121	12943	133	10287971	19275	391
378527-S100	17470	254	388930-S	12909	375	10005510	14968	498	10293193	20893	366
379046-S	8427	37	388930-S	12909	375	10008002	8814	107	10293368	19381	479
379830-S	9862	513	389129-S	12907	341	10008002	10052	107	10297369	20521	479
379830-S	14755	513	389138	12937	131	10009923	12259	66	10297370	20825	480
379830-S	14756	513	389144-S	17075	391	10013764	11352	498	10297371	19379	480
379831-S	8814	107	389258	10831	371	10014363	12997	97	10297372	19379	480
379831-S	10052	107	389358-S	10831	371	10017487	12931	131	10298115	19486	464
380575-S2	8847	22	389358-S	16259	371	10017615	14677	224	10301966	20365	489
380613-S	4439	131	389360-S	11865	467	10018202	12695	85	10305191	20814	392
380614-S	4440	341	389443-S	12571	373	10027015	17230	467	10308019	20521	479
380615-S	12209	341	3895904	12923	132	10031004	18014	201	10308063	20520	477
380707-S	11368	39	390018-S	17664	371	10032838	12713	468	10319395	20859	202
380707-S	11370	37	390126-S	14017	366	10036503	14023	245	10323057	20607	478
381671-S	10642	26	390126-S	14857	366	10040001	9282	232	10341794	20464	481
381801-S2	15774	27	390428-S100	17410	257	10041588	14527	104	10350983	21346	390
381818-S2	9880	104	390523-S	15675	532	10051034	15467	351	10351052	21347	466
381863-S2	9879	104	391304-S100	17606	331	10053182	14997	485	10351666	21222	211
382163-S	19826	102	391305-S100	17607	331	10053388	15045	493	10352797	20809	477
382413-S2	17460	28	391396-S100	17604	331	10062	12253	66	10352798	20973	477
382413-S9	17460	28	391397-S100	17605	331	10063599	18683	365	10352799	20808	477
382443-S	4439	131	3M8Z-1502316-A	20923	522	10069112	15488	245	10352803	19800	477
383000	12929	131	3M8Z-16K262-A	21304	516	10073833	12992	402	10352804	20974	477
383000-S	12929	131	3M8Z-17C432-A	21300	515	10077283	15042	493	10352809	20775	477
383001-S	12930	131	3U2Z-12S411-FKAA	20847	186	10078274	18897	366	10353835	20811	477
383001-S	12930	131	3U2Z-14S411-FKAB	20847	186	10082288	18390	476	10363352	21177	481
383003-S	12937	131	3U2Z-14S411-HZA	20848	185	10084751	19644	109	10363811	20634	390
383005-S	12931	131	3U2Z-14S411-HZB	20848	185	10089262	14987	485	10369649	21240	393
383016	12916	132	3U2Z-14S411-KGA	19885	193	10098645	18682	366	10382313	21176	494
383031	12927	133	3U2Z-14S411-SLB	20845	193	10102434	17436	509	10383817	21157	482
383033-S100	10780	357	3U2Z-14S4AA-SLA	20845	193	Freightliner					
			3W7Z-5422008-AA	18890	532	General Motors					

O.E.M. INTERCHANGE BY MANUFACTURER

O.E.M. No.	Auveco No.	Page No.	O.E.M. No.	Auveco No.	Page No.	O.E.M. No.	Auveco No.	Page No.	O.E.M. No.	Auveco No.	Page No.
10408480.....	19527	391	11503714.....	11864	108	11514623.....	12067	51	11569920.....	21158	476
10410398.....	19220	500	11503715.....	12575	108	11515478.....	12575	108	11569921.....	22037	NI 10
10421018.....	20338	392	11503716.....	11864	108	11515566.....	18781	59	11569973.....	20891	482
10423553.....	20481	479	11503736.....	14980	66	11515638.....	22074	NI 3	11570082.....	13614	53
10425306.....	20365	489	11503745.....	19205	65	11515756.....	11639	53	11570512.....	21156	479
10426555.....	21400	494	11503752.....	12595	64	11515757.....	13614	53	11570637.....	22070	NI 1
10426887.....	20775	477	11503754.....	12596	64	11516148.....	18477	201	11570830.....	21674	467
10431503.....	20775	477	11503756.....	12596	64	11516150.....	11630	109	11570846.....	21370	480
10431523.....	20810	477	11503785.....	18261	59	11516150.....	12667	109	11570847.....	22027	NI 10
10431524.....	19757	476	11503791.....	13715	51	11516372.....	20416	108	11571118.....	21535	391
10431526.....	20811	477	11503800.....	12324	51	11516397.....	20339	107	11571119.....	19759	400
10431761.....	19821	481	11503812.....	12064	51	11516440.....	3079	3	11571119.....	21536	391
10437565.....	19800	477	11503815.....	12322	51	11516596.....	13705	53	11571159.....	21443	376
10442914.....	20353	479	11503825.....	13618	52	11516780.....	15335	64	11571175.....	20934	479
10443956.....	20328	478	11503833.....	15788	52	11516807.....	20741	258	11571175.....	21242	479
10444839.....	21228	375	11503834.....	12065	52	11516936.....	18927	257	11571175.....	21374	479
10445899.....	21504	479	11503892.....	15373	59	11516942.....	13619	54	11588308.....	18461	255
10476561.....	9282	232	11503941.....	13617	51	11517071.....	11708	64	11588308.....	21327	245
106653.....	12543	172	11503957.....	11864	108	11517293.....	12596	64	11588441.....	21351	501
11500086.....	12350	61	11503957.....	12669	108	11517343.....	12065	52	11588650.....	20883	499
11500421.....	2775	4	11503958.....	13715	51	11517517.....	12324	51	11588818.....	21200	480
11500434.....	15373	59	11503982.....	12066	52	11517700.....	19449	380	11588863.....	20944	390
11500654.....	18337	107	11504010.....	15721	59	11517706.....	13619	54	11588988.....	20631	490
11500655.....	11625	107	11504035.....	11627	109	11517803.....	16622	490	11589015.....	12738	59
11500656.....	18338	107	11504047.....	16842	108	11517824.....	19297	487	11589176.....	20972	477
11500657.....	11626	107	11504056.....	12738	59	11517873.....	20452	467	11589181.....	21199	367
11500658.....	11628	109	11504230.....	1943	3	11517992.....	20615	376	11589182.....	20868	481
11500660.....	11629	109	11504288.....	12667	109	11518017.....	17216	491	11589244.....	20891	482
11500661.....	11630	109	11504493.....	12323	52	11518017.....	20632	491	11589289.....	19801	489
11500662.....	11631	109	11504531.....	9879	104	11518091.....	20170	261	11589289.....	20988	489
11500663.....	18339	109	11504536.....	13002	99	11518201.....	20281	373	11589290.....	13996	489
1150086.....	12350	61	11504565.....	13619	54	11518357.....	20377	478	11589290.....	14007	487
11500971.....	12348	53	11504567.....	13614	53	11518531.....	21027	500	11589290.....	14753	485
11500994.....	12057	61	11504570.....	12067	51	11518684.....	20415	501	11589290.....	20880	490
11500996.....	12339	61	11504614.....	15327	64	11518937.....	22117	NI 8	11589291.....	20989	490
11500997.....	12354	61	11504659.....	2710	1	11518988.....	21036	480	11589292.....	20991	491
11501105.....	11633	52	11504662.....	14046	2	11519023.....	21115	260	11589293.....	20889	491
11501188.....	13614	53	11504693.....	11626	107	11519023.....	21142	260	11589294.....	20992	491
11501193.....	11641	54	11504978.....	12666	108	11519031.....	20616	399	11589295.....	20993	492
11501194.....	13620	54	11504981.....	12068	61	11519032.....	21189	399	11589296.....	20994	492
11501794.....	12739	58	11504982.....	12343	53	11519408.....	21047	224	11609292.....	22035	NI 11
11501800.....	15334	64	11505005.....	12596	64	11519444.....	14010	487	11609317.....	20422	501
11501814.....	12254	66	11505022.....	12351	61	11519444.....	20359	490	11609411.....	12596	64
11501835.....	12253	66	11505023.....	12339	61	11519444.....	20631	490	11609417.....	20826	490
11501836.....	12255	66	11505044.....	18416	52	11519444.....	20888	490	11609483.....	21377	495
11501849.....	12260	66	11505104.....	13712	58	11519949.....	19239	594	11609535.....	20527	469
11501850.....	11645	65	11505182.....	14053	57	11519952.....	20422	501	11609651.....	21745	NI 8
11501883.....	12059	58	11505209.....	13618	52	11519960.....	20423	501	11609731.....	21115	260
11501884.....	12060	29	11505326.....	15790	53	11546635.....	22036	NI 10	11609738.....	14980	66
11501889.....	11644	65	11505329.....	12595	64	11546805.....	22071	NI 9	11609762.....	22081	NI 1
11501896.....	12061	27	11505329.....	16268	64	11547210.....	22029	NI 10	11609836.....	22121	NI 11
11501903.....	12062	58	11505596.....	18338	107	11547341.....	21835	NI 12	11609923.....	21667	480
11502483.....	12097	59	11506101.....	11645	65	11561143.....	12127	66	11609952.....	21027	500
11502507.....	15711	66	11506117.....	15335	64	11561329.....	21200	480	11609952.....	21754	NI 8
11502605.....	11639	53	11506174.....	12693	51	11561353.....	14998	486	11610049.....	21164	495
11502609.....	11644	65	11507036.....	11644	65	11561368.....	20888	490	11610086.....	15543	372
11502617.....	11629	109	11507036.....	16269	65	11561448.....	18153	500	11610157.....	21524	500
11502624.....	11639	53	11508023.....	12322	51	11561491.....	20884	481	11610210.....	21114	254
11502722.....	19309	65	11508241.....	12575	108	11561499.....	21383	390	11610271.....	14046	2
11502737.....	12127	66	11508269.....	13614	53	11561500.....	21384	469	11610383.....	21124	259
11502759.....	12126	66	11508275.....	15330	64	11561509.....	20261	52	11610495.....	21793	NI 9
11502770.....	10171	1	11508430.....	12339	61	11561654.....	21333	398	11610522.....	21157	482
11502785.....	11627	109	11508900.....	12253	66	11561655.....	20938	467	11610544.....	22040	NI 8
11502790.....	11935	53	11508927.....	13002	99	11561740.....	19644	109	11610605.....	21488	387
11502811.....	11709	64	11508930.....	15791	51	11561874.....	21361	493	11610606.....	21489	388
11502812.....	11708	64	11508987.....	14185	65	11561878.....	17222	488	11610705.....	20938	467
11502941.....	12693	51	11509189.....	12350	61	11561987.....	21518	469	11610747.....	21301	372
11503317.....	11630	109	11509371.....	12057	61	11562043.....	20995	390	11610748.....	21302	495
11503394.....	12740	58	11509374.....	12741	59	11562044.....	20996	390	11611079.....	21671	476
11503395.....	12741	59	11509511.....	11639	53	11562147.....	20868	481	11611110.....	21672	490
11503396.....	12742	59	11509535.....	15711	66	11562250.....	21242	479	11611375.....	21825	NI 9
11503421.....	12213	4	11509589.....	11638	53	11562256.....	20998	391	11611435.....	21827	NI 10
11503432.....	12117	66	11509816.....	12067	51	11562257.....	20999	391	11611623.....	22080	NI 10
11503455.....	12667	109	11510062.....	12253	66	11562364.....	21187	498	11611626.....	21739	NI 10
11503483.....	12742	59	11513599.....	21040	107	11562503.....	21753	NI 8	11612035.....	22100	NI 9
11503503.....	12097	59	11513798.....	20600	204	11562563.....	21128	478	11612122.....	22036	NI 10
11503578.....	18261	59	11513798.....	BH3	209	11562568.....	22034	NI 9	1165051.....	19626	691
11503619.....	13613	53	11513801.....	12738	59	11562588.....	21047	224	1165051.....	19627	691
11503632.....	12336	53	11513864.....	12064	51	11569618.....	20423	501	117971.....	4417	332
11503636.....	12213	4	11514282.....	15711	66	11569697.....	21161	482	119005.....	16897	203
11503668.....	13705	53	11514343.....	11639	53	11569700.....	22031	NI 9	1196781.....	3682	38
11503687.....	15310	62	11514518.....	11644	65	11569768.....	11146	371	12001470.....	13549	174
11503695.....	15335	64	11514596.....	11644	65	11569918.....	21129	479	12003757.....	13546	176

O.E.M. INTERCHANGE BY MANUFACTURER

O.E.M. No.	Auveco No.	Page No.	O.E.M. No.	Auveco No.	Page No.	O.E.M. No.	Auveco No.	Page No.	O.E.M. No.	Auveco No.	Page No.
12003758.....	13545	176	12083680.....	17172	177	12124076.....	20215	154	1355003.....	9069	466
12003759.....	12600	176	12083689.....	17173	177	12124304.....	15938	155	13584255.....	21220	179
12003878.....	13544	175	12084595.....	15948	151	12124515.....	8774	153	13585316.....	18868	178
12004005.....	12536	172	12084912.....	20209	156	12124580.....	15937	151	13586114.....	17110	178
12004009.....	12540	172	12084913.....	20210	156	12124581.....	18324	151	1366042.....	16739	22
12004010.....	16359	172	12085270.....	20752	159	12124582.....	15948	151	1370853.....	12735	466
12004188.....	19199	166	12085330.....	17174	177	12124587.....	18325	151	1377030.....	10365	468
12004201.....	8775	153	12085483.....	18916	177	12125637.....	11440	182	14002811.....	13002	99
12004311.....	12237	174	12085485.....	19882	180	12126451.....	18674	179	14003784.....	16986	62
12010085.....	15948	151	12085491.....	16968	180	12126452.....	15952	152	14004876.....	12931	131
12010182.....	15937	151	12085495.....	18868	178	12129373.....	20213	154	14005089.....	11854	486
12010293.....	18326	151	12085496.....	17114	177	12129409.....	20223	155	14005097.....	16248	99
12010300.....	15955	151	12085497.....	18524	178	12129484.....	20212	154	14007510.....	13231	21
12010717.....	15953	152	12085498.....	16694	178	12129493.....	18658	154	14007510.....	13232	21
12010973.....	15951	152	12085502.....	16964	180	12129497.....	18659	154	14007511.....	14976	21
12010974.....	18146	152	12085503.....	16514	179	12160374.....	20665	496	14007940.....	12999	97
12010975.....	18152	152	12085506.....	18918	180	12160551.....	20211	156	14008227.....	12210	341
12010996.....	15949	152	12085507.....	16965	180	12160857.....	20514	497	14011722.....	11109	22
12012000.....	14884	157	12085525.....	17109	179	12160858.....	20397	496	14013246.....	13960	466
12013813.....	13543	176	12085527.....	17109	179	12167116.....	18916	177	14017701.....	12930	131
12014012.....	14462	152	12085528.....	17109	179	12176844.....	19853	497	14017705.....	12923	132
12014254.....	20751	159	12085533.....	17199	180	12186456.....	20220	154	14017779.....	12947	133
12014836.....	14153	151	12085538.....	18917	178	12186457.....	20221	155	14017780.....	12924	132
12014837.....	14154	151	12089040.....	14150	151	12191645.....	16351	172	14019205.....	12567	487
12015024.....	18148	152	12089188.....	14151	151	12337831.....	20892	483	14019205.....	14007	487
120151.....	12546	172	12089189.....	13659	145	12337852.....	14031	466	14019226.....	14011	487
12015193.....	20618	151	12089189.....	19258	145	12337868.....	15518	503	14022878.....	12621	472
12015323.....	14152	151	12089190.....	13669	145	12337873.....	10054	107	14023108.....	12925	132
12015387.....	15923	152	12089190.....	19259	145	12337898.....	17341	351	14025274.....	12916	132
12015631.....	19795	496	12089191.....	13678	145	12337900.....	16953	495	14027471.....	12759	375
12015791.....	15950	152	12089191.....	19262	145	12337915.....	15490	246	14027775.....	20799	342
12015792.....	15952	152	12089305.....	15948	151	12337916.....	15783	22	14027776.....	20800	342
12015793.....	15954	152	12089306.....	18325	151	12337917.....	12669	108	14027777.....	20793	342
12015797.....	18145	152	12089307.....	20747	151	12337920.....	12737	401	14027778.....	20794	342
12015798.....	18147	152	12089340.....	16806	154	12337920.....	14524	401	14029095.....	12940	133
12015799.....	18151	152	12089649.....	14883	153	12337966.....	11630	109	14031114.....	12926	132
12015857.....	14881	154	12092075.....	16360	172	12338011.....	15467	351	14031144.....	12916	132
12015858.....	20216	154	12092080.....	16355	172	12338015.....	17437	509	14031145.....	12932	133
12015861.....	15938	155	12092081.....	16354	172	12338025.....	13009	99	14031900.....	16880	65
12015862.....	15948	151	12092344.....	20226	155	12338034.....	15453	340	14032200.....	14008	483
12015870.....	15945	155	12092345.....	20227	155	12338074.....	16936	510	14032291.....	14009	468
12015878.....	17002	153	12094429.....	20583	157	12338089.....	12594	472	14037239.....	18926	503
12015899.....	20749	151	12101855.....	18870	177	12338096.....	12824	472	14039420.....	14001	484
12015917.....	18324	151	12101856.....	18320	178	12338114.....	9112	125	14040999.....	16322	108
12015972.....	15952	152	12101857.....	18318	178	12338123.....	2775	5	14045480.....	14010	487
12015983.....	16941	496	12101859.....	18318	178	12338146.....	8814	107	14046480.....	12728	497
12020116.....	14880	154	12101869.....	18151	152	12338146.....	10052	107	14047034.....	12929	131
12020120.....	15939	155	12101880.....	18867	177	12338153.....	11621	252	14048060.....	13005	99
12020126.....	15944	155	12101895.....	17109	179	12353912.....	15463	350	14063981.....	13750	246
12020320.....	11948	153	12101897.....	16174	177	12354969.....	15948	151	14066728.....	17437	509
12020321.....	18650	153	12101898.....	16175	177	12354970.....	15937	151	14070914.....	13749	245
12020347.....	15935	153	12101903.....	17690	181	12355104.....	9481	150	14071289.....	14011	487
12020757.....	14883	153	12101906.....	16967	177	12355107.....	14150	151	14074081.....	14036	370
12020801.....	20748	151	12101909.....	13548	182	12355107.....	14153	151	14078435.....	11852	251
12027133.....	18923	176	12101909.....	17691	182	1244839.....	9965	691	14082956.....	18817	59
12033674.....	14150	151	12101917.....	13686	170	12450053.....	18001	201	14083173.....	14820	500
12033817.....	15960	153	12101927.....	19554	182	12450143.....	8884	207	14083901.....	14952	57
12034046.....	15947	154	12101933.....	18316	181	12450143.....	8893	207	14090382.....	19278	59
12034047.....	15946	154	12101937.....	17113	179	12450176.....	20595	203	14090908.....	16026	222
12034051.....	14151	151	12101939.....	18871	183	12450313.....	8921	206	14093088.....	14020	526
12034342.....	18149	152	12102568.....	17463	180	1247872.....	15459	501	14093311.....	10831	371
12040902.....	15924	153	12102620.....	16693	178	12519972.....	18429	473	14093869.....	14980	66
12040983.....	19851	496	12102621.....	14580	179	12519975.....	18417	473	14097279.....	16739	22
12040984.....	19440	496	12102664.....	21490	178	12530252.....	17654	247	14100784.....	17382	500
12041351.....	20618	151	12102747.....	17110	178	12533567.....	17103	488	14101262.....	15702	493
12043215.....	16694	178	12102748.....	18527	179	12535713.....	19398	402	14103026.....	12084	249
12045234.....	15927	171	12102757.....	19555	182	12540326.....	19725	507	14103026.....	17424	250
12045236.....	15926	171	12103360.....	20230	155	1254815.....	11838	465	14103435.....	16953	495
12045773.....	18653	154	12103881.....	15497	154	1255823.....	11865	467	14103438.....	15042	493
12046624.....	16693	178	12110842.....	20217	155	1257702.....	14217	497	14103461.....	15043	492
12047581.....	15498	154	12110843.....	20219	155	1260888.....	19166	105	14103461.....	15045	493
12047680.....	15497	154	12110844.....	20218	155	1264963.....	12713	468	142451.....	20292	202
12047767.....	15499	154	12110845.....	20222	155	127934.....	16910	201	142451.....	B68	206
12048074.....	18654	154	12110846.....	20225	155	127934.....	20703	210	142452.....	16911	201
12048369.....	14918	177	12110847.....	20224	155	127934.....	B57	206	142452.....	20705	210
12052922.....	16806	154	12116958.....	17111	178	1304225.....	4249	339	142453.....	18015	201
12065158.....	18150	152	12117353.....	18526	181	131282.....	16914	201	142454.....	16926	201
12066214.....	14881	154	12117354.....	19556	181	13144822.....	21541	60	142456.....	16923	201
12066614.....	20231	155	12117361.....	17109	179	13252118.....	21365	387	142456.....	B1141	206
12076946.....	17175	176	12117375.....	18526	181	13252119.....	21364	388	145525.....	14388	215
12083005.....	16585	176	12117384.....	13547	182	13365058.....	22025	NI 9	1480627.....	8359	106
12083006.....	16586	176	12117385.....	17107	179	13503401.....	16902	201	1480909.....	8377	106
12083007.....	17108	174	12117387.....	18145	152	13503417.....	8885	207	1494252.....	8359	106
12083460.....	18924	174	12124075.....	20214	154	1351769.....	9112	125	1494253.....	10830	106

O.E.M. INTERCHANGE BY MANUFACTURER

O.E.M. No.	Auveco No.	Page No.	O.E.M. No.	Auveco No.	Page No.	O.E.M. No.	Auveco No.	Page No.	O.E.M. No.	Auveco No.	Page No.
1494254	10054	107	15672713	18167	252	1619321	12137	374	19260663	21072	504
1494257	10051	106	15678493	17215	377	1619321	16263	374	19260663	21582	506
1494258	8814	107	15679091	14953	522	1621253	12935	131	19299324	20485	504
1494258	10052	107	15681408	17103	488	1623436	12998	97	19300089	13659	145
15002520	18262	499	15682898	18262	499	1631564	15478	374	193065	18474	201
15014352	20943	485	15683327	21387	498	1635218	12999	97	19630330	19389	474
15015804	18889	259	15685040	19424	508	1636632	16624	489	1999366	16898	203
15025531	19616	499	15685099	20415	501	1638575	19162	105	1999367	20859	202
15026222	20158	559	15686047	15792	21	1640810	15373	59	1999482	20620	202
15026223	20157	559	15686142	18153	500	1644290	18948	366	20030401	15457	377
15029828	4369	339	15690531	18744	244	16500308	14016	488	20032850	11679	367
15031239	17654	247	15691493	16936	510	16502342	20301	36	20037597	12314	510
15037290	10080	548	15691595	19424	508	16503329	14002	465	20043351	19183	508
15040331	21290	501	15694099	18391	390	16503548	14145	466	20043361	19183	508
15056810	20362	374	15704030	19515	257	16506582	17000	462	20046147	14559	508
15061964	21195	345	15705372	11246	462	16510893	15676	465	20046150	11816	471
15076791	20444	398	15707256	19317	39	16524431	18662	203	20058837	18398	482
15078238	20860	499	15709521	18262	499	1654047	11345	348	20064875	15456	377
15116576	20935	480	15714775	11655	463	1660123	11717	471	20085729	17073	352
15127746	20934	479	15714775	11871	464	16606936	17069	502	20097200	12569	514
15149708	19639	489	15715058	17654	247	16607593	14967	548	2011554	12084	249
15153415	19615	491	15718794	13755	245	16609280	19399	502	2011554	17427	250
15175428	12930	131	15732202	18028	245	16611888	18420	476	20123070	15467	351
15199562	B4114K	206	15733970	19614	469	16611889	18418	473	20130258	13002	99
15209748	21106	171	15733971	19613	469	16615006	19370	475	20130258	13003	99
15221959	20865	477	15737532	12520	86	16627328	20675	548	20160591	15466	351
1522266	8375	106	15737533	12522	86	16629990	19658	503	20162174	17176	351
152267	8372	106	15745990	20527	469	16630688	21196	502	20169887	12135	348
152273	15677	106	15745991	20529	469	16630689	21197	502	20171942	12594	472
15227654	20792	342	15748479	20268	499	16632192	16937	510	20175051	12563	471
15227655	20792	342	15748479	20268	499	16632193	16936	510	20199675	14642	472
15236893	20951	481	15762170	14921	365	16633853	17069	502	20200750	18510	379
15236894	20952	478	15763285	14921	365	16662182	19519	499	20237057	12602	472
15281294	20864	464	15764320	19616	499	16674629	20189	372	2024778	18938	260
15282120	20935	480	15769308	21290	501	16675980	19658	503	2024781	8300	240
15288146	20885	478	15772605	16908	201	16715497	17468	256	20274997	12824	472
15289020	20527	469	15772605	B2057A	206	16723225	12084	249	20298365	11677	402
15296830	20990	490	15773445	14753	485	16723225	17427	250	20319841	12731	373
15300530	19882	180	15786626	19819	351	1688094	11425	471	20325696	12656	254
15305932	18524	178	15802005	21338	373	1689827	12095	27	20328600	15467	351
15306157	21006	176	15822417	21474	171	1706200	13828	472	20331307	12568	497
15326410	19836	366	15824471	20945	558	1729250	11485	470	20338568	13925	469
15328724	16352	172	15828918	B3157A	206	1732326	12315	510	20345137	14549	509
15502538	8931	240	15862656	21033	181	1746408	18817	59	20346654	14217	497
15505451	16251	99	15862656	21542	181	176653	16134	66	20348200	12315	510
15506827	14012	246	15864780	22037	NI 10	17988488	14820	500	20351035	12065	52
1550971	18474	201	15872008	20884	481	17997722	14820	500	20363491	13999	488
15545178	18926	503	15893516	20885	478	1839906	18953	148	20374473	12737	401
15545202	15670	402	15931605	21379	399	19115561	11083	166	20374473	14524	401
15562609	16937	510	15944588	21248	372	19115586	19199	166	20376243	4441	339
15562610	17976	508	15953247	17649	402	19115640	21476	171	20393536	14033	472
15567924	15459	501	15954398	19429	467	19116359	21475	171	20413107	11612	366
15569071	20797	342	15955172	13752	246	19119304	21752	NI 3	20421672	13752	246
15569072	20798	342	15955523	17654	247	19130464	10649	219	20421800	12992	402
15588024	13946	402	15956062	18169	256	19130464	14547	496	20423550	15774	27
15588078	14032	370	15956470	14998	486	19130464	20471	496	20423647	13747	245
15591860	19424	508	15958694	11146	371	19149964	20450	65	20426301	14260	676
15596279	14031	466	15958694	15414	371	19152583	14524	401	20429451	13992	401
15596280	14037	468	15959832	18268	493	19168447	13669	145	20429500	14553	509
15596301	13946	402	15959833	18334	493	19206781	15499	154	20430956	13858	497
15597271	14215	471	15960325	18353	494	19207416	21193	558	20432975	13748	245
15598757	15792	21	15960621	19355	488	19209790	21828	NI 3	20433026	13753	246
15600382	12992	402	15963179	16938	391	19209791	21829	NI 3	20444103	13458	472
15606344	20792	342	15964971	16936	510	19209792	21830	NI 3	20451119	13457	484
15606409	20792	342	15964972	16937	510	19209793	21831	NI 3	20451401	13461	401
15607139	18105	499	15967691	19424	508	19209793	21831	NI 3	20452072	14753	485
15607165	15970	402	15969147	17216	491	19209794	21832	NI 3	20453400	12064	51
15612948	15970	402	15975244	19834	372	19209795	21833	NI 3	20455900	14006	365
15614746	21028	245	15986343	18371	370	19209796	21834	NI 3	20461373	13856	495
15614774	18244	257	15986673	19356	391	19209797	21749	NI 3	20462090	16865	483
15622490	17615	254	15989431	21380	376	19209798	21750	NI 3	20465395	14005	245
15632790	17508	500	15989487	19387	495	19209799	21751	NI 3	20475949	14013	483
15638413	16938	391	15993201	16622	490	19209800	21752	NI 3	20475950	14014	466
15641800	11110	22	15994165	20542	489	19257054	16898	203	20477732	16687	255
15646148	17343	508	1600375	10759	463	19257054	B9006	208	20477850	15464	351
15648833	14988	522	1605396	11146	371	19257055	B9004	208	20478294	13860	495
15650655	9880	104	1605396	15414	371	19257057	20599	204	20478295	13456	495
15653790	19781	507	1606642	11657	463	19258649	21006	176	20478733	15462	350
15659161	17072	379	1610403	12917	132	19260056	21487	507	20480475	13453	401
15672149	19242	484	1614858	12931	131	19260058	21404	505	2048248	11673	373
15672183	19782	507	1617333	12919	132	19260060	21403	505	20493450	17455	351
15672328	17599	403	1618890	11470	463	19260061	21406	506	20510029	13993	489
15672330	14998	486	1618890	11657	463	19260063	21444	506	20511451	13454	368

O.E.M. INTERCHANGE BY MANUFACTURER

O.E.M. No.	Auveco No.	Page No.	O.E.M. No.	Auveco No.	Page No.	O.E.M. No.	Auveco No.	Page No.	O.E.M. No.	Auveco No.	Page No.
20514862	15367	367	22536642	18298	366	25633289	18422	474	3540146	17640	261
20538173	18302	365	22537749	14220	468	25640501	3138	101	3540161	16940	259
20547865	14147	492	22538004	14993	486	25642453	17103	488	3540161	19057	240
20570245	13994	492	22538102	14990	485	25648693	20280	475	354076	11246	462
20582532	18392	502	22539533	15462	350	25649667	20466	468	3540858	18308	491
20582533	18393	502	22543363	17176	351	25663903	20265	486	354400	12939	133
20590899	13996	489	22550254	17545	470	25672428	20279	402	3548011	17640	261
20603072	11152	348	22566142	15684	251	25680782	14991	485	3548690	17640	261
20606417	14946	471	22566221	17106	488	25691949	20522	475	3548693	19363	469
20612732	13746	245	22569178	18927	257	25693852	19822	478	3548804	18685	372
20624923	14014	466	22578985	18911	470	25695687	19892	487	357020	12918	132
20626174	19394	352	22579423	18927	257	25696693	19759	400	358501	8746	85
20632190	17666	482	22585836	18912	256	25704001	20522	475	362069	11638	53
20635065	13994	492	22587036	18310	493	25704141	19758	400	362379	11245	462
2064891	10621	401	22587341	12081	249	25704358	21428	468	363137	15461	401
2064891	16260	401	22595587	14988	522	25705182	21517	61	363137	16017	401
20652520	18679	374	22599312	20263	472	25707329	20244	494	365270	11718	463
20664092	14753	485	22600612	18930	399	25718851	20326	476	3655015	4233	339
20668704	16624	489	22603384	19820	478	25722671	20318	475	3664645	4237	338
20699808	14921	365	22615352	19732	468	25724529	20774	478	367291	14976	21
20712176	15463	350	22638717	13750	246	25732397	21081	36	367292	12995	97
20713843	15684	251	22638717	20740	258	25742293	20976	477	367292	12996	97
20732399	10831	371	22641917	18912	256	25744385	21503	481	3688699	8963	722
20734005	17092	402	22642756	20262	374	25749564	21227	377	3688811	4235	338
20747508	17341	351	22643056	18889	259	25762391	19758	400	3689084	4236	339
20747509	17159	351	22644361	19522	488	25774893	21375	482	3693292	4250	339
2075380	19055	240	22646099	19428	399	25775903	21335	482	3711168	4265	338
2084421	8774	153	22649878	11691	466	25796285	21681	NI 10	3722635	2619	692
2085119	16940	259	22649879	11691	466	25803643	22026	NI 8	3722635	12958	692
2085119	19057	240	22651066	18930	399	25822063	21287	375	3744999	2752	692
2085823	19060	240	22657634	19787	485	25847343	21045	558	3744999	12960	692
20985619	21045	558	22657634	19788	485	25922739	21370	480	3745361	4280	338
21006725	18023	224	22659122	19335	484	26019392	20094	560	3762180	4280	338
21011332	12254	66	22677979	20666	486	26019395	20097	560	3764554	9469	501
21021319	18749	258	22677980	20666	486	26019399	20101	560	3783002	5278	35
21030249	17216	491	22690838	21246	486	271022	10773	81	3783006	5228	38
21030249	17216	491	22691056	21091	389	274004	18472	201	3783794	5195	100
21035018	14031	466	22718305	15480	373	274007	18473	201	380370	8418	39
21035345	19297	487	22718369	21238	487	279670	12523	86	380382	9829	465
21039129	17975	378	22722859	20634	390	279670L	12521	86	3816659	10649	219
21039141	17215	377	22722860	20635	469	279670R	12523	86	3828472	18329	257
21042045	17218	389	23223178	20945	558	279671	12521	86	383569	8623	18
21042053	17218	389	24100042	21047	224	2852065	20156	559	383569	8624	18
21042058	17218	389	2419255	8905	240	2962447	8774	153	383569	8625	18
21042098	17214	485	24205245	20528	365	2962448	8777	153	3846202	15783	22
21042104	17218	389	24233099	21093	224	2962510	11440	182	3863669	8942	465
21047094	16816	488	24405739	22024	NI 10	2962953	17115	157	3866846	15345	82
21075387	19101	51	24405740	22022	NI 10	2962984	8775	153	3876130	16240	99
21075686	17222	488	24449408	21540	107	2962987	8776	153	3893980	10330	465
21077123	19801	489	24501057	21090	373	2965142	15957	153	389809	13757	379
21077131	17616	493	24574578	14988	522	2965470	14892	157	3899596	14030	466
21077323	17226	426	2477054	8895	239	2965580	15504	157	3900684	4369	339
21077405	17227	486	2495701	8938	240	2971962	15956	153	3901067	19932	563
21077575	18033	381	25015169	12237	174	2973215	18690	154	3907444	8435	39
21093588	17219	472	2501569	12237	174	2973216	18651	154	3907444	11719	39
21094146	16818	369	25016383	11612	366	2973932	9905	174	3919773	11691	466
21094240	18515	51	25016383	11680	366	2974309	8756	175	3920179	11352	498
21094747	17220	245	25099299	20163	494	2977373	11442	182	3921446	9851	464
21095797	18896	492	25117765	18925	178	2977607	11444	181	3921988	19130	223
21097229	19854	488	25508532	12566	468	2978302	8755	174	3923948	10090	464
21098967	19397	350	25512081	12729	497	2978302X	8755	174	3927320	9481	150
21110145	16816	488	25512688	19162	105	30006620	19257	397	3944866	9965	691
21110201	16818	369	25514221	11675	367	30008324	19243	484	3944866	12971	691
2201406	12522	86	25522466	9285	232	30012018	14696	595	3946988	2710	1
2201407	12520	86	25524005	14004	245	3065575	11796	401	3960314	10362	21
2207713	16132	372	25525798	14220	468	3065575	16261	401	3963228	11738	132
22189414	20360	372	25526447	19435	468	3078511	11130	377	3977775	11130	377
22505958	12934	132	25527289	14822	102	332364	10831	371	3982098	8359	106
22508049	12932	133	25530441	14527	104	332364	16259	371	3984469	10653	4
22508050	12918	132	25535963	19472	495	342271	16253	99	3985058	11424	466
22508051	12937	131	25536302	14820	500	343543	11246	462	3986997	11109	22
22508052	12927	133	25552852	18422	474	343555	11243	462	3997391	14030	466
22508803	11419	133	25552853	18423	474	343555	11245	462	3998009	15759	503
22512276	12766	374	25552856	17979	473	343555	11246	462	4001934	13467	379
22512276	16262	374	25554845	19361	470	3455559	11253	464	400764	4473	340
22512857	12605	463	25556911	19166	105	347065	16237	99	400765	4474	340
22513813	12605	463	25601491	18174	369	347347	13450	465	407217	11110	22
22514924	14821	465	25603960	18389	365	347893	11292	102	4081765	4188	338
22516030	20450	65	25605716	14527	104	3526573	19358	473	409988	4417	332
22527147	18748	499	25609048	17641	258	3533539	16940	259	411700	11721	366
22527720	14035	370	25618730	17121	257	3533539	19057	240	4137121	4242	338
22529733	2293	103	25630330	19389	474	35366964	21047	224	413945	8744	85
22531616	11631	109	25630331	19411	474	3536966	18665	222	414188	19168	85
22535007	15044	493	25631448	19417	61	3538469	21047	224	416629	12069	359

O.E.M. INTERCHANGE BY MANUFACTURER

O.E.M. No.	Auveco No.	Page No.	O.E.M. No.	Auveco No.	Page No.	O.E.M. No.	Auveco No.	Page No.	O.E.M. No.	Auveco No.	Page No.
4234830	15518	503	557057	11655	463	88970495	20578	659	9414767	2734	1
4417599	8447	693	557057	11871	464	88970656	20575	394	9415465	2366	3
444613	9278	232	557057	12605	463	88970767	20869	676	9416042	2712	1
444619	9279	232	559312	11655	463	88973654	20578	659	9416444	2709	1
444620	9279	232	559312	11871	464	88973676	20577	677	9416927	16909	201
444667	9285	232	559547	11836	467	88974848	B194	206	9416927	20715	210
444776	9283	232	560625	12937	131	88980509	20872	503	9416927	B1893	206
444777	9283	232	560692	11419	133	88980510	20872	503	9417276	1937	3
444782	9284	232	562327	11831	498	88981030	15674	548	9417561	20285	202
444789	9285	232	568792	19626	691	88981031	15673	548	9417863	16906	201
445429	11292	102	568792	19627	691	88986451	18868	178	9417863	B1895	206
4457495	10220	471	574355	19626	691	88987187	21220	179	9417866	16904	201
4457595	10220	471	574355	19627	691	88987962	17109	179	9417866	B1156	206
4459049	9342	362	575411	2789	692	88988301	18527	179	9418420	12083	249
4490167	9477	483	575411	12961	692	88988609	21212	178	9419740	5655	2
4492962	10318	472	588546	15037	27	8900524	11948	153	94198687	14697	595
4492962	11288	471	5949838	3178	464	8901283	11166	174	9420052	12097	59
4495047	9367	501	5963268	11156	175	89023920	21168	558	9420850	11923	3
4533699	8583	347	5970995	16230	97	89024363	20945	558	9421330	16902	201
454626	16919	201	5973400	12757	487	8902487	11446	175	9421330	B194	206
454645	16925	201	5973823	19847	487	89025539	20485	504	9421777	16912	201
454646	18004	201	5973996	12756	488	89025543	21092	504	9421777	B97	206
455136	16920	201	6263345	11138	470	89025546	21072	504	94218027	17195	632
455490	16918	201	6270163	10832	371	89026634	21385	377	94221150	14727	648
4563173	4240	339	6271903	20801	342	89026635	21386	377	9422339	18469	201
4564974	4264	339	6271904	20803	342	8903202	11154	175	9422552	11292	102
4565415	4240	339	6271905	20802	342	8903202	11475	176	94226492	14269	395
458030	12316	510	6271906	20804	342	8903283	11446	175	9423101	19777	35
4637277	20175	691	6271989	14559	508	8903488	12629	163	9424837	9880	104
4657731	2628	348	6272766	12918	132	8903488	15372	163	9425491	9881	104
4676189	19807	692	6280765	3617	362	8903489	12628	163	9425542	16921	201
4689929	2744	691	6288704	8777	153	8904437	11156	175	9425542	20706	210
4689929	2818	691	6292995	12629	163	8905087	15959	153	9425542	B168	206
4689929	12962	691	6292995	15372	163	8905794	20471	496	9426331	12547	172
4699315	2619	692	6294493	13548	182	8909518	11156	175	9426334	12545	172
470433	20795	342	6298886	9883	174	8909908	11446	175	9427587	18013	201
470434	20796	342	6298886	11166	174	8911472	14546	496	9427761	10666	102
4721222	4281	340	6298886	13558	174	8911473	14544	496	9427882	9282	232
4723818	2789	692	6298892	9883	174	8911497	14545	496	9427909	8925	240
4723818	12961	692	6298892	13558	174	8912698	11157	175	9427943	20289	202
472434	11699	487	6298935	9883	174	8912750	13540	174	9428481	3796	102
472450	15453	340	6299087	11157	175	8913369	14885	157	9428902	16899	201
472812	12935	131	6466355	12920	132	8914822	11154	175	9428902	B1157	206
472814	12921	132	7634583	9275	347	8914822	11475	176	9428904	16901	201
472815	12922	132	7637192	4441	339	8914823	11476	175	9428904	B1157A	206
4730773	20175	691	7642589	13467	379	8915135	12629	163	9431530	9880	104
474821	14976	21	7693140	9639	347	8915136	12628	163	9431647	2293	103
4755299	8435	39	7698976	9633	347	8917225	18451	157	9431808	16913	201
4759145	2943	691	7724826	4447	339	8917283	17002	153	9431809	18011	201
4761842	2943	691	7730788	9749	347	8917320	14547	496	9432137	16687	255
4767559	4446	339	7731589	9850	471	8917444	11083	166	9432552	16686	255
4778814	2744	691	7731589	10632	361	8917528	15959	153	9433040	18010	201
4778814	2818	691	796255	11349	400	8918527	9883	174	9433043	11628	109
4778814	12962	691	8717859	10243	348	8918527	11166	174	9433143	20286	202
4779348	2943	691	8731909	3620	382	8919916	13543	176	94331546	20582	104
4801268	3620	382	8731909	11120	365	8933059	10318	472	9433155	9879	104
480534	10832	371	8733059	10318	472	8933059	11288	471	9433156	20582	104
4853108	8398	693	8733059	11288	471	90321122	21088	388	9433184	18016	201
4872948	4446	339	8734067	10242	347	91171148	18661	203	9433186	18168	258
4876498	10744	379	8799350	10617	471	91171148	20601	204	9433373	10171	1
4877000	8385	693	88662264	21490	178	91173701	15926	171	9433489	11614	18
4877001	8386	693	88891731	19424	508	91176726	20417	478	9433489	11615	18
4879431	9229	27	88891791	18889	259	9132667	22088	NI 4	9434229	18732	240
4879481	8448	693	88909758	12548	172	916581	9884	183	9436175	11620	251
4883164	8399	693	88909760	12536	172	916581	9885	183	9436175	16837	251
4886720	8447	693	88909760	12550	172	916632	9916	183	9436750	16922	201
490067	11770	19	88909761	12551	172	916638	9884	183	9436789	18465	201
490067	11771	19	88909762	12552	172	916638	9885	183	9436790	20284	202
513388	4243	338	88909763	12553	172	92095787	B885	207	9437173	18008	201
516637	8744	85	88909764	12554	172	92095788	21222	211	9437173	20710	210
528846	13004	99	88909765	12555	172	92139147	22041	NI 9	9437173	B912	206
5297428	18952	148	88909766	12556	172	92139150	22089	NI 4	9437486	12655	252
534343	11831	498	88909769	12547	172	92231490	18501	245	9437643	20402	252
547944	4439	131	88909770	15505	172	93356553	19781	507	9437846	14486	252
5480772	20863	492	88909771	15506	172	94051993	16859	645	9437938	11621	252
5480852	20756	479	88909772	15507	172	9411017	9265	229	9437938	16838	252
5482087	21284	498	88909773	15508	172	9411019	9266	229	9438068	18012	201
5482103	20881	387	88909774	15509	172	9411022	9257	228	9438068	B194A	206
549790	11640	53	88938226	14921	365	9411031	9260	228	9438150	11246	462
554343	11831	498	88953358	21033	181	94113207	17271	467	9438848	16907	201
55568037	21650	225	88953358	21542	181	94145515	17076	372	9438848	B2057	206
556196	11665	463	88969790	20576	387	9414716	3079	3	9438850	16908	201
556539	11667	463	88970345	20559	393	9414722	1943	3	9439559	18749	258
556992	12932	133	88970494	20577	677	9414723	2808	3	9439719	12657	259

O.E.M. INTERCHANGE BY MANUFACTURER

O.E.M. No.	Auveco No.	Page No.	O.E.M. No.	Auveco No.	Page No.	O.E.M. No.	Auveco No.	Page No.	O.E.M. No.	Auveco No.	Page No.
9440178	9879	104	9716926	14549	509	90109-SW3-003	19470	368	90674-SA6-003	12580	582
9441592	18167	252	9721917	14550	509	90114-SE0-000	20259	60	90674-SB0-000	14268	665
9441723	B890	207	9731301	11152	348	90114-SZ3-000	20259	60	90674-SC6-003	15474	584
9441724	20598	204	9786454	9354	19	90116-S82-A01	19439	577	90675-692-003	14306	578
9441724	B891	207	9786454	9355	19	90212-SA5-003	16470	65	90675-692-0031	14306	578
9441725	12083	249	9786454	9356	19	90418-SW3-003	19470	368	90675-SA5-003	22105	NI 3
9441728	B880	207	9795883	10068	19	90471-PX4-000	16955	222	90675-SA6-003	14294	586
9441731	16896	203	9796223	10714	32	90505-SM4-003	17057	596	90675-SA6-0030	14294	586
9441732	16897	203	9808241	10630	348	90505-SX0-003	19453	594	90675-SB0-003	16000	596
9441732	B9005	208	9815325	14967	548	90601-SH3-014	17442	580	90675-SB3-003	16000	596
9441733	16898	203	9818648	10621	401	90602-S2A-003	21696	NI 17	90676-SA7-003	17058	586
9441770	8938	240	9822198	14548	509	90602-S5A-003	21059	397	90676-SR4-003	18115	588
9441837	18017	201	9838109	10318	472	90602-S7S-003	20611	387	90677-671-003	14687	597
9441837	B24	206	9838109	11288	471	90602-SAA-003	21087	396	90677-693-003	14687	597
9441838	18000	201	9854717	10631	348	90602-SX0-003	21107	388	90677-SE0-003	16950	597
9441838	20721	210	9883583	10621	401	90602-TA0-003	21417	572	90679-692-003	14308	578
9441838	B2357A	206	9883583	11774	401	90603-S7S-003	20612	586	90679-692-0030	14308	578
9441839	16915	201	9883583	16260	401	90605-SF1-003	17089	581	90681-693-000	14280	586
9441839	20722	210	9895598	10701	348	90612-SF1-003	17320	581	90682-SB0-003	17058	586
9441839	B3057	206	HONDA			90651-SL9-013	19454	588	90682-SDA-A01	21205	587
9441840	16916	201	217-770	15932	171	90651-SL9-0130	19454	588	90682-SEA-003	20954	587
9441840	B3057A	206	217-771	15933	171	90651-TP8-003	21705	NI 17	90683-693-000	14690	586
9441854	17998	201	33111-SR3-A01	18661	203	90652-SB2-023	16949	597	90683-693-0000	14690	586
9441866	17999	201	33111-SR3-A01	20601	204	90653-HC4-900	17222	488	90683-SA5-003	19311	596
9441866	20720	210	33111-SR4-A01	B9005	208	90654-SA4-003	19730	597	90683-SA6-003	14685	582
9441866	B2357	206	33116-S2A-003	BH1	209	90655-SA0-003	14288	585	90683-SA6-0030	14685	582
9441923	18018	201	33116-S4-A11	B9006	208	90655-SA0-0030	14288	585	90683-SC6-003	14685	582
9441923	20702	210	33116-S7-003	BD2S	209	90656-671-6310M1	14287	586	90683-SC6-0030	14685	582
9441923	B24A	206	33165-SAA-003	BH11	209	90657-SA6-003	14697	595	90684-SA5-003	14696	595
9441941	2808	3	33303-SD4-671	16901	201	90657-SA6-0030	14697	595	90685-SA5-003	14356	386
9441956	18005	201	34301-692A-0000	14317	585	90657-SB0-003	19186	593	90687-671-003	14319	386
9442003	17996	201	34355-SD2-003	15997	578	90658-SB0-003	14701	582	90687-671-003	14319	386
9442004	B3156	206	34906-SL0-A01	20296	202	90658-SB0-0030	14701	582	90687-671-0030	14319	386
9442081	17997	201	34906-SL0-A01	20730	210	90661-SC7-003	14695	587	90687-SA5-003	14282	383
9442361	17641	258	38211-SD2-000	15932	171	90661-SC7-0030	14695	587	90687-SA5-0030	14282	383
9442486	18001	201	38212-SE0-000	15933	171	90662-671-003	14313	586	90687-SB0-003	17287	595
9442486	B3157A	206	38529-689A-6300	14323	386	90662-671-0030	14313	586	90687-SB0-013	17287	595
9442492	18478	201	60658-SB3-000	17289	598	90662-693-003	14281	587	90687-SB2-901ZF	17287	595
9442877	B881	207	60658-SD2-000	17289	598	90662-693-0031	14281	587	90688-SB0-003	14968	498
9442878	20596	204	66421-634-000	14291	383	90662-SB2-003	14313	586	90688-SB0-013	14968	498
9442879	20683	203	66435-648-000	14291	383	90664-671-003	14328	379	90692-SA5-0030	14290	593
9442880	B889	207	66435-648-0000	14291	383	90664-692-0300	16861	585	90694-SB0-003	17281	584
9442881	20599	204	71144-SR3-A00	18415	588	90664-SB0-004	15472	584	90694-SB0-0030	17281	584
94467458	17355	348	71591-S5A-000	21636	580	90664-SB3-003	20303	587	90700-SB2-003	15998	376
94515340	16136	64	71592-S5D-000	20603	578	90665-SA0-9700	12576	577	90713-SB0-003	14705	584
94530385	21299	476	71598-S30-013	20677	578	90665-SM4-000	19646	587	90866-SB0-000	20350	585
94530438	21112	485	72311-S10-003	19673	366	90666-SA0-003	14289	366	91500-SM4-999AH	16960	36
94530565	21070	393	72311-S5S-003	21704	NI 17	90666-SA0-0030	14289	366	91501-S04-003	19118	594
94530742	21316	476	72413-SF1-003	17270	580	90666-SA0-003A3	14289	366	91501-S1K-003	20609	378
94841226	14750	680	72413-SF1-0030	17270	580	90666-SA0-003A9	14289	366	91501-S1K-003	20882	384
94842841	18297	383	72431-S2X-003	21639	579	90666-SA0-003ZD	14289	366	91501-SM4-003	17205	385
94847334	17383	486	73156-SS0-004	17488	585	90666-SD9-000	20351	585	91501-SM5-A00	19680	581
94848189	18330	382	73862-672-003	14299	379	90667-671-013ZA	20381	384	91501-SNA-003	22054	NI 17
94848192	18330	382	73862-672-0030	14299	379	90667-S0D-003ZC	20334	369	91501-STK-003	20609	378
94848834	15695	657	74806-SB6-003	16825	585	90667-S0D-003ZK	21303	367	91501-SWA-003	21652	378
94849113	18297	383	74807-SB0-004	17454	584	90667-S0D-003ZK	21303	367	91501-TR0-003	21651	594
94852368	19140	635	74842-659-003	16779	386	90667-SAT-003	16775	371	91502-S84-A11	19683	381
94854203	19194	467	74842-659-0030	16779	386	90667-SAT-0030	16775	371	91502-S9A-003	21216	580
94858299	18876	396	75305-S0A-003	20783	579	90667-SAT-003ZB	16775	371	91502-SM4-000	17143	597
94858338	19312	367	75305-SH2-003	20784	579	90668-688-003	14296	586	91502-SM4-000	19407	597
94858343	19726	484	75305-SH4-003	20785	579	90668-688-0030	14296	586	91502-SPO-003	18119	597
94858560	18873	677	75305-SHJ-003	21186	578	90668-SAT-000	14296	586	91503-S3Y-003	21419	579
94858864	19645	484	75305-SM4-A01	21556	579	90668-SB0-003	14698	596	91503-S7A-003	21297	594
95005064	14144	396	75306-SDA-A01	20782	581	90669-671-000	14284	680	91503-SHJ-A01	21454	595
95008221	19129	398	75306-SV1-A01	20602	579	90669-671-0000	14284	680	91503-SZ3-003	19233	573
95230842	21529	490	75306-SZA-A01	21470	578	90669-671-003	14284	680	91503-SZ5-003	20564	595
9590477	12675	85	75307-SN7-000	20570	65	90669-SB0-003	19487	632	91503-T2A-A01	21796	NI 16
9591699	12695	85	75315-S9A-004	22136	NI 17	90669-SPO-003ZA	19744	368	91504-SM4-000	17144	596
9591855	19168	85	75316-S9A-004	21557	578	90669-SPO-003ZB	19744	368	91504-SM4-000	19408	596
9601750	20562	502	75329-SH4-013	21109	579	90670-692-003	16781	384	91504-SP1-003	21558	579
96057846	17162	487	75521-611-000	14274	664	90670-SG0-003	19741	587	91504-SR3-003	20432	597
96057847	17383	486	75521-611-0000	14274	664	90671-S0D-003ZK	21303	367	91505-S9A-003	20986	594
96061699	14367	365	75522-611-000	14255	585	90672-671-003	18157	383	91505-SG0-003	17280	584
96061863	17356	499	76222-SP1-003	21772	NI 16	90672-671-8110M1	14268	665	91505-S77-003ZA	20910	595
96064506	19128	678	90009-PH1-000	21353	224	90672-SA0-003	14298	598	91505-TM8-003	21706	NI 17
9617200	11118	482	90009-PY3-000	20426	225	90672-SA0-0030	14298	598	91506-S9A-003	21173	573
9624520	11066	347	90009-R70-A00	20426	225	90672-SAG-003	14700	584	91507-SH3-003	17632	523
96585564	21167	558	90106-SW3-003	19650	588	90672-SAG-0030	14700	584	91508-S50-003	19547	593
9662548	17233	483	90107-S0X-A01	21521	588	90673-SC6-003	14703	584	91508-SM4-003	17192	594
9662950	11067	347	90107-S10-003	19533	588	90673-SC6-0030	14703	584	91508-SR3-000	18165	594
9669486	11855	466	90107-SX0-003	19734	588	90674-692-003	12580	582	91510-SR3-003	17981	580
9685057	11678	401	90108-SS0-003	20331	578	90674-692-0030	12580	582	91511-SR2-004	19223	582
9711304	15759	503	90108-SW3-003	19470	368	90674-SA5-003	14293	593	91512-S50-003	21555	579
97134978	17355	348				90674-SA5-0030	14293	593	91512-SE0-003	18512	597

O.E.M. INTERCHANGE BY MANUFACTURER

O.E.M. No.	Auveco No.	Page No.	O.E.M. No.	Auveco No.	Page No.	O.E.M. No.	Auveco No.	Page No.	O.E.M. No.	Auveco No.	Page No.
AB5-8A.....	18731	240	FD02-50-798.....	20579	618	MERCEDES-BENZ			MINI COOPER		
AB6-10A.....	18489	240	G030-68-885-B-38.....	14709	367	A901-988-00-25.....	21843	NI 22	07-13-0-702-516.....	21137	392
AB6-2.....	8295	240	G031-58-762.....	18692	381	000-987-10-81.....	13157	627	07-13-0-702-715.....	20570	65
AB6-2A.....	5755	240	G032-68-865A-00.....	21560	368	000-988-15-81.....	13141	627	07-130-702-966.....	17267	573
AB6-4.....	8307	240	G043-50-742.....	20460	387	000-988-16-25.....	20647	627	07-13-1-480-419.....	21709	NI 23
AB6-4A.....	8311	240	G14S-50-EA1.....	21769	NI 22	000-988-55-81.....	13144	627	07-13-2-757-821.....	21659	631
AB6-6.....	8297	240	G18K-51-SJ3.....	20932	388	000-988-76-81.....	13141	627	07-13-7-073-915.....	21527	631
AB6-6A.....	8301	240	G350-68-AB1.....	18824	392	000-988-86-25.....	20404	627	07-14-7-145-753.....	21139	393
AB6-8A.....	8938	240	G6JA-50-0Z5.....	20957	617	000-990-03-92.....	13230	628	51-41-0-407-984.....	21788	NI 15
AB8-6A.....	19058	240	GA2A-56-399A.....	19753	619	000-990-22-92.....	13230	628	51-41-8-224-768.....	21788	NI 15
ABL4-2A.....	8922	240	GA2A-56-694.....	14709	367	000-990-29-2.....	21859	NI 22	51-43-7-001-491.....	21138	395
ABL4-4A.....	8931	240	GA2A-58-762.....	19481	380	000-990-34-92.....	20187	628	51-71-1-496-621.....	21143	380
ABL4-8A.....	20474	240	GA2A-68-AB1A.....	20459	392	000-990-37-92.....	20314	628	51-71-7-127-742.....	21716	NI 23
ABL6-10A.....	19057	240	GA5R-56-392.....	19306	622	000-990-40-92.....	20640	628	51-77-7-171-002.....	21787	NI 15
ABL6-4A.....	19055	240	GD7A-50-EA1.....	20755	623	000-990-44-92.....	20639	628	MINI COOPER		
ABL6-6A.....	8313	240	GJ21-50-034.....	17060	623	000-990-46-92.....	20641	628	AB009006.....	16898	203
ABL6-8.....	19051	240	GJ21-50-049.....	17003	625	000-990-54-92.....	20234	576	HB121467.....	14720	386
ABL6-8A.....	19056	240	GJ21-50-H81.....	17551	516	000-990-57-92.....	20642	387	MB020923.....	19385	384
AC4-2.....	8908	240	GJ21-50-H82.....	17552	516	000-990-60-92.....	21859	NI 22	MB023930.....	14366	618
AC4-2A.....	8299	240	GJ21-51-036.....	16555	615	000-990-84-92.....	21037	628	MB029111.....	14277	664
AC4-4.....	8914	240	GJ21-58-502A.....	19743	618	000-991-59-40.....	21711	NI 22	MB098145.....	14275	665
AC4-4A.....	8928	240	GJ21-58885-A69.....	18206	622	000-994-04-45.....	13224	67	MB106212.....	14335	640
HP-2.....	7915	241	GJ21-68-885B-02.....	21024	525	000-994-06-45.....	13218	68	MB132008.....	14335	640
HP-30A.....	7982	241	GJ21-68885-B69.....	18206	622	000-994-09-45.....	13220	69	MB153825.....	17195	632
HP-30B.....	7983	241	GJ6A-50-ES1.....	21304	516	000-994-14-45.....	13215	68	MB253964.....	17351	635
HP-30C.....	7984	241	GJ6A-58-975.....	21743	NI 21	000-994-14-45.....	13216	68	MB271999.....	20565	633
HP-30D.....	7985	241	GJ6A-68-162.....	20958	617	000-994-25-45.....	13223	67	MB325299.....	16671	680
HP-30N.....	7981	241	GJ6E-50-715-A.....	20923	522	001-988-03-25.....	21105	386	MB358818.....	15926	171
SB3-2.....	19044	239	GJ6R-68-ABX.....	20983	393	001-988-12-25.....	20646	627	MB358819.....	15927	171
SB3-4.....	19045	239	GK2A-50-798.....	21300	515	001-988-20-81.....	16124	67	MB383455.....	14331	639
SB4-1.....	19046	239	GM9E-63-938A.....	20960	617	001-988-20-81.....	20205	626	MB419858.....	19487	632
SB4-2.....	5749	239	GS3L-68-615.....	21413	618	001-988-44-81.....	21464	625	MB547806.....	17472	647
SB4-3.....	8874	239	H001-50-609.....	14719	616	001-988-46-81.....	21466	625	MB566720.....	19334	388
SB4-4.....	5753	239	H001-50-841.....	14695	587	001-988-49-81.....	21433	625	MB608104.....	19129	398
SB4-6.....	8880	239	H001-68-719B.....	17451	619	001-988-50-81.....	21441	626	MB608137.....	19343	631
SB4-8.....	19047	239	H115-67-099.....	15926	171	001-988-60-81.....	21468	625	MB608140.....	19330	632
SB5-2.....	8883	239	H116-67-099.....	15927	171	001-988-63-81.....	21469	626	MB608156.....	19475	632
SB5-4.....	8886	239	H117-67-099.....	15931	171	001-988-76-81.....	20205	626	MB619582.....	21140	635
SB6-10.....	8902	239	H260-50-6K8.....	22064	NI 21	001-988-80-81.....	21465	626	MB645307.....	21025	537
SB6-2.....	8889	239	HG30-50-6B9A.....	19648	617	001-990-00-91.....	20651	67	MB655630.....	22082	NI 23
SB6-4.....	8892	239	J001-56-741.....	21520	385	001-990-169-2.....	21859	NI 22	MB696120.....	19320	387
SB6-6.....	8895	239	JOY1-50-619C.....	19452	617	001-994-98-45.....	21823	NI 22	MB814419.....	19314	632
SB6-8.....	8899	239	KA01-50-H15A.....	17554	517	002-988-51-81.....	20897	625	MB817060.....	20573	633
SBL4-2.....	8291	239	KA01-50-H16.....	17553	517	002-997-33-86-67.....	18302	365	MB846992.....	20572	632
SBL4-4.....	8293	239	LA01-50-6A8A.....	19831	617	003-988-41-78.....	20188	400	MB869072.....	19331	383
SBL6-12.....	18814	239	LA01-56-135.....	14750	680	003-990-02-51.....	21431	576	MB879499.....	22077	NI 23
SBL6-4.....	18811	239	LB82-50-669A.....	19755	616	003-990-24-97.....	21184	257	MB880455.....	19745	632
SBL6-6.....	8305	239	N304-13-356A.....	14697	595	003-990-35-97.....	22122	NI 5	MB887567.....	17351	635
SBL6-8.....	18812	239	NA01-50-101A.....	19228	615	003-990-94-97.....	20971	255	MB888561.....	19324	633
SC4-2.....	5751	239	NA01-56-145.....	16858	646	003-994-30-45.....	13218	68	MC440901.....	20381	384
SC4-4.....	8303	239	NE51-51-SJ3A.....	21678	NI 21	004-988-76-78.....	20657	625	MD050317.....	19007	222
SSB4-4S.....	19060	240	S084-58-502.....	20463	619	004-988-77-78.....	20657	625	MF453091.....	21746	NI 2
SSB6-8S.....	19061	240	S51S-51-833.....	21662	621	004-990-16-97.....	21286	260	MR138807.....	18951	635
SSBN4-3.....	11104	253	TO01-50-M48B.....	19450	616	006-988-30-78.....	20201	625	MR154128.....	19474	632
53130.....	12657	259	TD11-56-694.....	21661	367	006-988-35-78.....	20199	626	MR200300.....	20247	594
53181.....	12654	260	TD12-51-SJ3A.....	21412	389	006-988-89-78.....	21434	626	MR201466.....	19328	635
MAZDA			UB39-45-919.....	20465	622	007-988-34-78.....	20879	394	MR221507.....	21623	657
B001-68-302-00.....	16777	385	UB39-50-795.....	19747	622	007-988-71-78.....	21467	626	MR288150.....	21658	634
B003-68-865-00.....	21755	NI 21	UB42-67-013.....	19754	625	007-988-99-78.....	20879	394	MR322000.....	21690	NI 23
B003-68-865-96.....	17453	367	1243-50-609.....	12591	617	1149900192.....	21859	NI 22	MR435918.....	20571	387
B092-50-609.....	17290	616	1395-68-676.....	14369	434	123-990-00-92.....	20636	629	MR478262.....	20580	543
B092-50-715.....	17195	632	8133-50-022.....	14380	386	123-990-02-92.....	20637	629	MR478263.....	20581	538
B092-51-833.....	17632	523	8173-50-931.....	12589	616	123-990-05-92.....	21044	628	MR587315.....	21073	562
B100-68-8550.....	21110	622	9924-90-512B.....	14367	365	123-994-08-45.....	20650	68	MS452348.....	21744	NI 2
B101-68-252-00.....	17478	622	9926-40-531B.....	18271	384	124-988-04-78.....	21435	626	MS480001.....	14255	585
B173-50-852A.....	19451	616	9926-40-543A.....	14349	383	124-988-90-78-M89.....	22115	NI 22	MS480002.....	13932	663
B27K-51-PS7.....	22049	NI 22	9926-50-625.....	14260	676	124-988-94-78.....	21759	NI 22	MS480009.....	13932	663
B455-56-135.....	21862	NI 22	9926-50-635.....	14369	434	124-990-04-92.....	20909	629	MS480012.....	14695	587
B455-56-741.....	18458	385	9927-40-821.....	14363	400	124-990-05-92-9051.....	20640	628	MU000319.....	19239	594
B467-68-AC3-02.....	21858	NI 22	9927-40-822.....	16778	400	124-990-07-92.....	20203	629	MU435004.....	16254	99
BBM450355.....	20971	255	9927-40-825.....	14269	395	12499007929C75.....	20203	629	MU480001.....	21632	535
BC1D-56-145.....	19315	623	9927-70-901.....	14378	624	126-990-03-92.....	21044	628	MU480034.....	19322	633
BC1M-50-0Z5.....	20984	617	9927-80-404.....	14365	624	140-698-00-82.....	20656	626	MU481027.....	19325	380
BF67-50-033.....	15366	623	9927-80-405.....	14359	624	201-988-04-78.....	20202	625	MU481187.....	19323	384
BF67-50-235.....	17450	623	9928-90-753.....	14376	624	201-990-00-50.....	20645	629	MU840004.....	15931	171
BF82-50-233.....	16843	623	9928-91-053.....	14298	598	201-990-02-92.....	20638	629	MU840015.....	15926	171
BP4K-58-762.....	21307	385	9956-41-400.....	19621	222	201-990-05-36.....	21774	NI 2	MU840016.....	15927	171
BP4L-51-SJ3.....	21171	616	9991-00-402.....	14366	618	201-997-22-81.....	20659	627	MU840021.....	15931	171
BW0A-50-792.....	19138	619	9991-00-403.....	14364	618	211-988-00-81.....	20773	626	106212.....	14335	640
E11451W24.....	21561	616	9991-00-412.....	13930	639	230-990-01-92.....	21086	629	MOTORCRAFT		

O.E.M. INTERCHANGE BY MANUFACTURER

O.E.M. No.	Auveco No.	Page No.	O.E.M. No.	Auveco No.	Page No.	O.E.M. No.	Auveco No.	Page No.	O.E.M. No.	Auveco No.	Page No.
WPT-169	20843	190	26297-9B91A	BDS2	209	76988-3DNOA	22032	NI 24	AD42ABSLF	8922	240
WPT-173	18671	192	26398-ED000	21850	NI 25	76988-3J000	19736	641	AD42BS	8905	240
WPT-335	20848	185	26557-2U001	21824	NI 24	76988-4N000	21291	637	AD43-45BS	19025	244
WPT-793	20847	186	26717-89950	B1156A	206	76996-01P02	16776	369	AD43-45BSLF	19034	244
NISSAN (Includes Infiniti)			26717-9B90E	B3057	206	76997-P7100	14723	385	AD44ABS	8925	240
H0564-7Y000	21042	562	27158-Q0100	17634	366	78856-R4301	14690	586	AD44ABSLF	8931	240
H0564-7Y010	21042	562	27948-M7002	14348	384	79796-71E00	17349	638	AD44BS	8911	240
01241-00551	17193	649	40224-21001	14253	85	79896-P7100	14333	638	AD45-47BS	19026	244
01241-00881	21459	649	40224-EJ20A	14253	85	80850-89900	21633	381	AD46ABS	16031	240
01281-00022	14331	639	54229-0201P	16340	347	80850-CA003	21588	385	AD48ABS	16032	240
01281-00023	14275	665	62228-51S00	19147	649	80850-CA003	21588	385	AD48BS	19049	240
01281-0005U	21318	641	62228-7Y000	21108	639	80850-JM01A	22107	NI 24	AD52-54BS	18743	244
01281-00151	14335	640	622A2-9E000	21361	493	80874-AX000	21646	648	AD52-54BSLF	17468	256
01281-00231	14275	665	622A2-9E000A	21361	493	80875-85E00	18166	382	AD52ABS	18727	240
01281-00331	21111	641	62318-01W00	16860	637	80999-05N00	16784	677	AD53-55BS	19027	244
01281-00441	17342	639	62319-0W000	20266	639	80999-VE000	20668	395	AD53ABS	18728	240
01281-00501	21367	640	62380-U7400	17196	641	80999-VE000	21414	394	AD54ABS	18729	240
01281-00601	19293	640	62660-48600-1	20381	384	84653-N7400	14337	648	AD54ABSLF	18732	240
01281-00691	21324	640	62698-V7000	14313	586	84915-0W000	19731	394	AD54BS	19050	240
01281-00711	20604	640	62869-N4700	14723	385	84953-AU100	21640	396	AD56ABS	18730	240
01281-00801	17342	639	63844-01A00	16858	646	84953-JA00A	21289	395	AD58ABS	18731	240
01281-00831	20764	639	63844-01A99	14726	645	84995-3J101	21631	646	AD61OABS	18489	240
01281-01081	20736	641	63844-D0100	14727	648	85099-0B720	19293	640	AD61OABSLF	19057	240
01281-01121	19741	587	63846-5V000	21768	NI 24	85099-1VA0A	22123	NI 24	AD62-64BS	18744	244
01281-01321	21425	602	63846-9E000	20813	642	85222-0M000	20790	641	AD62-64BSLF	19036	244
01515-0009U	21113	255	63848-01G00	16782	595	85222-0M00A	20790	641	AD6270UG	17421	250
01553-00051	14356	386	63848-35F00	19735	649	85284-J5J00	21701	NI 25	AD62ABS	5755	240
01553-00172	14737	383	63848-40Y00	20613	646	85284-7S610	21160	602	AD62BS	8295	240
01553-00202	14347	386	63848-9E001	20327	646	85284-AD000	21147	602	AD63-66BS	19028	244
01553-00291	14355	382	63848-9Y000	21664	649	85284-CD000	21117	638	AD6437UGX	17422	250
01553-0034U	17350	596	63848-D0100	17193	649	89427-98070	16775	371	AD64ABS	8311	240
01553-0038U	21311	646	63848-D4000	17385	649	92470-N8200	18135	331	AD64ABSLF	19055	240
01553-00401	14355	382	63848-D4001	17385	649	92470-N8210	18135	331	AD64BS	8307	240
01553-0052U	20671	384	63854-01A00	17472	647	92471-N8200	18139	331	AD66-68BS	19029	244
01553-00545	17452	383	63876-95596	16000	596	92472-N8200	18134	331	AD66-68BSLF	19037	244
01553-0075U	18948	366	63878-01E10	20348	646	92473-N8200	18142	331	AD66ABS	8301	240
01553-01121	17452	383	65624-V0100	14337	648	92474-N8200	18138	331	AD66ABSLF	8313	240
01553-01182	20256	366	65722-EA000	21309	648	92475-W1000	18140	331	AD66BS	8297	240
01553-01393	16843	623	65810-K2000	21229	381	92475-W2100	18144	331	AD68-612BS	19030	244
01553-01733	20196	675	65810-K2002	22060	NI 25	96706-89901	14366	618	AD68ABS	8938	240
01553-01781	17634	366	65810-K2009	19724	382	96706-B0700	13930	639	AD68ABSLF	19056	240
01553-01A50	21519	366	65832-F5000	17237	378	96706-B6700	13930	639	AD68BSLF	19051	240
01553-02253	21821	NI 29	65846-30F00	17237	378	96706-H2500	14724	640	AD82-86BS	19031	244
01553-02741	17378	647	65846-40F00	19468	376	96706-H9400	14335	640	AD8375UG	17423	250
01553-02821	20670	392	65846-4Z000	17237	378	96706-K1300	14335	640	AD8625UGX	17424	250
01553-02903	22063	NI 25	65846-4Z000	19468	376	96706-K1351	14335	640	AD86ABS	19058	240
01553-02913	21621	640	65846-4Z000	21288	376	96706-N8000	14334	639	AK42ABS	8299	240
01553-02923	21688	NI 23	66814-01G00	16725	448	96706-P0105	14274	664	AK42BS	8908	240
01553-03101	17378	647	66820-3S500	20672	388	97606-B0700	13930	639	AK44ABS	8928	240
01553-03201	20753	647	66820-3S510	20614	638	99604-H1400	16780	679	AK44BS	8914	240
01553-03831	21121	637	66820-61U00	21689	NI 25	NUTURN					
01553-05131	21637	648	66820-88E00	17633	642	W-159	15004	86	R4357	11104	253
01553-05323	21192	603	66820-9N00A	22128	NI 25	W-246	15018	87	SD32BS	19044	239
01553-06071	21620	645	66820-AX020	21159	645	W-486	15009	86	SD34BS	19045	239
01553-06451	22075	NI 25	66824-01G00	16783	645	W-487	15010	86	SD41BS	19046	239
01553-06721	17347	647	66824-W1000	14725	647	W-6	15017	87	SD42BS	5749	239
01553-07111	20669	396	66860-01W01	16859	645	W-8	15015	86	SD42BSLF	8291	239
01553-08231	21545	646	68425-H5000	14313	586	OPEL					
01553-08911	21618	637	72727-W1000	15470	638	03-446-243	12642	650	SD43BS	8874	239
01553-08961	21295	382	72774-01F00	14331	639	1104882	21859	NI 22	SD44BS	5753	239
01553-09241	19246	646	72826-01P00	15468	638	1719245	21859	NI 22	SD44BSLF	8293	239
01553-09311	19684	381	73856-51E00	17348	638	1-74-713	12642	650	SD46BS	8880	239
01553-09321	19274	647	73858-8J000	20873	637	1-74-820	19153	650	SD48BS	19047	239
01553-09431	21134	646	73858-ZB00A	20873	637	1-76-651	13207	650	SD52BS	8883	239
01553-09611	20349	677	74798-S9000	14695	587	20-72-175	13220	69	SD54BS	8886	239
01553-09791	20668	395	76847-1JB0A	22055	NI 24	3467-531	19153	650	SD610BS	8902	239
01553-10051	19905	647	76848-54C00	22059	NI 23	PEUGEOT/CITROEN					
01553-2DR9A	22039	NI 25	76848-71S00	21622	641	16-092-672-80	21812	NI 34	SD612BSLF	18814	239
01553-2U001	21824	NI 24	76848-8J010	20786	641	6822 LL	21822	NI 35	SD62BS	8889	239
01553-S3500	13945	400	76876-W5000	14352	383	6822 LL	21822	NI 35	SD64BS	8892	239
01553-S3500A	13945	400	76881-0P000	20166	641	6973.A9	21813	NI 35	SD64BSLF	8305	239
01651-00481	14695	587	76881-9E000	19897	639	6983.17	21809	NI 35	SD68BS	8899	239
10998-30880	14696	595	76882-0E700	21617	638	6991.S6	21814	NI 34	SD68BSLF	18812	239
11026-01M02	21258	222	76882-0M000	21017	649	6991.S6	21814	NI 34	SD816BS	19048	239
11026-JA00A	21258	222	76882-0M060	21619	637	6992.31	21808	NI 35	SD8375UG	17427	250
11128-01M0B	21293	223	76882-57A00	18265	645	6997.T2	21810	NI 35	SD8625UGX	17428	250
11296-AG000	20953	647	76882-6P000	20886	601	8211.WV	21811	NI 35	SK42BS	5751	239
24220-89986	14345	648	76882-6P010	22076	NI 24	POP					
24225-89960	21259	649	76882-EG01A	21285	637	AD32ABS	19053	240	SSD44SSBS	19060	240
24274-M3000	14346	648	76882-EW00B	21683	NI 24	AD41-43BSLF	19033	244	SSD6270UG	17429	250
255Y3616-10	12585	638	76882-JG10A	22061	NI 24	AD42ABS	8309	240	SSD68SSBS	19061	240
26023-H1000	13931	639	76884-90100	12583	638	PORSCHE					
26296-9B91D	BH9	209	76906-T3000	14353	386	823-867-299	20252	400			

O.E.M. INTERCHANGE BY MANUFACTURER

O.E.M. No.	Auveco No.	Page No.	O.E.M. No.	Auveco No.	Page No.	O.E.M. No.	Auveco No.	Page No.	O.E.M. No.	Auveco No.	Page No.
RENAULT/DACIA			77553-65D00.....	20743.....	656	67771-22020.....	14728.....	395	81121-17010.....	16558.....	656
77-03-072-360.....	21807.....	NI 34	77553-65D10.....	22079.....	NI 27	67771-30070.....	19109.....	393	81124-89101.....	16951.....	656
77-03-072-416.....	21812.....	NI 34	83942-65D00.....	22078.....	NI 27	67771-30090.....	19129.....	398	81137-22530.....	21628.....	663
77-03-077-080.....	21800.....	NI 34	TOYOTA			67771-32090.....	18844.....	395	81150-1A750.....	21628.....	663
77-03-077-225.....	21806.....	NI 34	00234-01156.....	16904.....	201	67771-32120.....	21686.....	NI 30	81496-21010.....	21684.....	NI 28
77-03-077-231.....	21802.....	NI 34	00234-01156.....	B1156.....	206	67771-58010.....	21369.....	657	82711-12200.....	21553.....	680
77-03-077-435.....	21805.....	NI 34	12157-10010.....	21116.....	222	67771-89104.....	19203.....	394	89785-08020.....	21101.....	562
77-03-077-468.....	21814.....	NI 34	47749-58010.....	20757.....	667	67773-0E020.....	21795.....	NI 30	89785-60160.....	21101.....	562
77-03-077-468.....	21814.....	NI 34	51453-0E010.....	21860.....	NI 30	67867-0C010.....	20443.....	381	90075-10004.....	21628.....	663
SEAT/SKODA			51453-48010.....	21860.....	NI 30	67867-12150.....	19749.....	381	90075-10801.....	19783.....	517
N908-131-01.....	21817.....	NI 35	51453-48010.....	21860.....	NI 30	67867-28030.....	18692.....	381	90075-10805.....	19783.....	517
4A0-805-163.....	21815.....	NI 33	51454-0E010.....	21856.....	NI 30	67867-89103.....	18692.....	381	90080-46010.....	21296.....	383
4A0-867-276.....	21818.....	NI 36	51454-48010.....	21856.....	NI 30	67868-30030.....	21627.....	365	90080-46269.....	19797.....	658
SUBARU			52115-0C090.....	21221.....	660	67868-89101.....	18692.....	381	90080-46294.....	21325.....	676
11126AA000.....	19139.....	222	52115-48040.....	21132.....	660	67869-12050.....	21551.....	386	90080-81041.....	16897.....	203
46064AE000.....	21593.....	654	52161-02020.....	18873.....	677	67869-20030.....	21548.....	365	90080-82014.....	12540.....	172
57160FC000.....	21568.....	655	52161-16010.....	18873.....	677	67921-32010.....	19719.....	387	90080-82050.....	21603.....	172
57160FC010.....	22042.....	NI 26	52161-20010.....	20931.....	677	68211-06020.....	19531.....	659	90080-82051.....	21436.....	172
57728AC090.....	19246.....	646	52197-22020.....	22096.....	NI 28	68211-07010.....	19380.....	659	90080-82052.....	21437.....	172
57750AA090.....	21578.....	655	52197-52010.....	21133.....	660	68211-95D00.....	19722.....	661	90080-82053.....	21166.....	172
57750FC010.....	21577.....	652	52535-0E010.....	21015.....	665	69293-12030.....	20469.....	679	90080-82055.....	21438.....	172
59122AC030.....	21580.....	655	52535-0E030.....	21712.....	NI 27	69293-12040.....	20470.....	679	90084-26001.....	17420.....	250
59122FA010.....	21571.....	654	52535-30150.....	21583.....	665	69293-12050.....	20534.....	679	90084-26002.....	20383.....	255
62731FA000.....	21629.....	652	52535-50060.....	21015.....	665	69293-12060.....	20535.....	679	90084-26008.....	17411.....	250
62731FA010.....	21587.....	652	53145-16020.....	18846.....	665	69293-30030.....	21336.....	679	90084-46020.....	21071.....	659
661179000.....	22044.....	NI 26	53271-0B010.....	22102.....	NI 31	69293-33010.....	20469.....	679	90084-98033.....	18661.....	203
693005370.....	21584.....	392	53271-12040.....	22102.....	NI 31	69293-33020.....	20470.....	679	90084-98033.....	20601.....	204
803916010.....	21326.....	226	53271-12060.....	22102.....	NI 31	69951-12180.....	18113.....	639	90099-14044.....	18136.....	331
807016160.....	21326.....	226	53271-44010.....	20738.....	656	75392-04010.....	21016.....	659	90099-14045.....	18143.....	331
90331AA050.....	21565.....	380	53326-08010.....	21211.....	378	75392-0R010.....	21016.....	659	90105-06037.....	21840.....	NI 1
90331GA090.....	21573.....	382	53384-68010.....	22126.....	NI 29	75392-35200.....	21016.....	659	90159-50316.....	21839.....	NI 2
90814FC001.....	21322.....	653	53452-90351.....	17611.....	679	75392-35220.....	21857.....	NI 27	90159-60303.....	22106.....	NI 2
909130003.....	21585.....	654	53455-14020.....	14732.....	679	75392-42030.....	21841.....	NI 2	90159-60488.....	21838.....	NI 2
909130007.....	21567.....	388	53455-33010.....	19529.....	679	75395-0T010.....	21453.....	657	90159-60525.....	21837.....	NI 2
909130008.....	21771.....	NI 26	53455-33011.....	19529.....	679	75395-14020.....	14264.....	659	90159-A0001.....	21839.....	NI 2
909130013.....	21658.....	634	53813-48011.....	22132.....	NI 29	75395-35070.....	20688.....	658	90183-03001.....	16306.....	680
909130034.....	21574.....	393	53857-47011.....	22103.....	NI 29	75396-35020.....	20687.....	658	90189-04008.....	14277.....	664
909130051.....	21594.....	655	53867-47020.....	21237.....	667	75397-35010.....	20688.....	658	90189-04011.....	14271.....	663
909130059.....	21563.....	655	53879-14010.....	14750.....	680	75495-35010.....	20687.....	658	90189-04013.....	14268.....	665
909130067.....	21530.....	654	53879-14010.....	19669.....	680	75498-42010.....	19843.....	658	90189-04014.....	14256.....	663
909130074.....	21421.....	376	53879-14020.....	14750.....	680	75545-12050.....	15475.....	661	90189-04019.....	14263.....	665
909130109.....	21591.....	388	53879-14020.....	19669.....	680	75545-14081.....	14747.....	663	90189-04022.....	17224.....	663
909130213.....	21502.....	396	53879-20020.....	21613.....	681	75545-16020.....	14751.....	662	90189-04031.....	18843.....	664
909140002.....	21576.....	444	53879-22010.....	14276.....	681	75545-28010.....	14749.....	663	90189-04057.....	14271.....	663
909140007.....	21420.....	655	53879-22030.....	14750.....	680	75545-32020.....	16833.....	661	90189-04059.....	21151.....	664
909140012.....	21570.....	654	53879-30040.....	21797.....	NI 31	75545-32030.....	17485.....	661	90189-04066.....	14281.....	587
909140051.....	21422.....	654	53879-58010.....	20758.....	667	75545-88080.....	14749.....	663	90189-04102.....	21544.....	664
909140052.....	21592.....	654	53879-60010.....	20335.....	676	75545-88080.....	14749.....	663	90189-04150.....	19265.....	664
909140054.....	19233.....	573	53888-48010.....	21225.....	677	75545-89101.....	16942.....	663	90189-04176.....	19840.....	664
909140055.....	21501.....	655	53935-35020.....	21162.....	660	75546-12030.....	16821.....	663	90189-05012.....	14739.....	664
909140062.....	22160.....	NI 26	55799-12010.....	19841.....	665	75546-12050.....	14746.....	662	90189-05013.....	13932.....	663
909140063.....	21500.....	655	61118-35010.....	21194.....	657	75546-12060.....	19204.....	661	90189-05082.....	19187.....	665
909300007.....	22044.....	NI 26	61991-35010.....	21234.....	660	75546-22050.....	14745.....	662	90189-05105.....	20431.....	664
909300015.....	21569.....	652	61992-35010.....	21235.....	660	75546-22060.....	17334.....	661	90189-05142.....	21191.....	665
91017FA080.....	21562.....	651	62217-13010.....	20558.....	392	75547-22010.....	17298.....	662	90189-06001.....	14275.....	665
91059FC030.....	21581.....	651	62217-33031.....	22158.....	NI 29	75547-51021.....	21082.....	255	90189-06003.....	14266.....	667
91059FC041.....	22050.....	NI 26	62581-14020.....	16778.....	400	75548-16010.....	17330.....	662	90189-06005.....	14273.....	667
91059FC090.....	21572.....	651	62955-12010.....	15695.....	657	75548-22150.....	19484.....	662	90189-06006.....	14265.....	665
91059FC110.....	21564.....	651	62955-20020.....	15695.....	657	75548-24020.....	14278.....	662	90189-06010.....	14274.....	664
91084AA010.....	22043.....	NI 26	65613-07010.....	21337.....	680	75548-32010.....	14731.....	662	90189-06013.....	14267.....	667
91085TA030.....	21566.....	654	67771-01010.....	14144.....	396	75791-0W010.....	15707.....	396	90189-06018.....	14258.....	664
91167AA000.....	21579.....	652	67771-02030.....	15709.....	396	75791-33020.....	21008.....	659	90189-06028.....	19194.....	467
91167FA010.....	22046.....	NI 26	67771-02030.....	15709.....	396	75819-33010.....	21748.....	NI 28	90189-06029.....	19505.....	666
91486KJ010.....	21590.....	652	67771-02030.....	19898.....	396	75867-02010.....	21226.....	671	90189-06042.....	14695.....	587
91486KJ010.....	21531.....	652	67771-03030.....	15707.....	396	75867-06030.....	21596.....	678	90189-06065.....	20440.....	666
94078FA080.....	22048.....	NI 26	67771-04040.....	19210.....	397	75867-21010.....	20576.....	387	90189-06084.....	19505.....	666
94081FA010.....	21575.....	652	67771-06010.....	18844.....	395	75867-30110.....	19842.....	369	90189-06104.....	19742.....	609
94415FA000NE.....	22047.....	NI 26	67771-06030.....	19109.....	393	75867-30120.....	21123.....	677	90189-06111.....	19783.....	517
95022AC040ML.....	21630.....	368	67771-12010.....	14269.....	395	75867-30130.....	22056.....	NI 30	90189-06114.....	20412.....	667
99045AE03AMA.....	21589.....	367	67771-12010F.....	14269.....	395	75867-33030.....	21538.....	672	90189-06116.....	19505.....	666
SUZUKI			67771-12030.....	15709.....	396	75867-AA010.....	21012.....	388	90189-06145.....	21625.....	609
09409-04304.....	14367.....	365	67771-12040.....	19016.....	397	75867-AA010.....	21538.....	672	90189-06157.....	19721.....	666
09409-06309-5ES.....	21691.....	NI 27	67771-12050.....	18898.....	106	75867-AC020.....	21653.....	658	90189-06162.....	18747.....	656
09409-07303-5ES.....	19128.....	678	67771-12050.....	19257.....	397	76647-42010.....	21616.....	680	90189-06177.....	21411.....	667
09409-07313.....	17383.....	486	67771-12070.....	20473.....	388	76817-12060.....	21612.....	659	90189-06193.....	20895.....	664
09409073255PK.....	19243.....	484	67771-12080.....	20575.....	394	76853-100					

O.E.M. INTERCHANGE BY MANUFACTURER

O.E.M. No.	Auveco No.	Page No.	O.E.M. No.	Auveco No.	Page No.	O.E.M. No.	Auveco No.	Page No.	O.E.M. No.	Auveco No.	Page No.
90269-05035	17420	250	90467-08155	19140	635	9098113075	BH11	209	1H0-853-585-A	21396	684
90269-05035	20626	258	90467-08179	19910	396	90982-08188	15926	171	1H0-853-585-B	21395	683
90269-05054	20626	258	90467-08180	20910	595	90982-08189	15927	171	1H0-853-586	21397	685
90269-05056	21713	NI 5	90467-08185	20349	677	90982-08202	15930	171	1H0-853-733B	19136	682
90269-06013	20834	258	90467-08186	20184	368	90982-08203	15931	171	1H0-867-199-01C	21789	NI 32
90269-06017	21315	260	90467-08186-CO	20184	368	90982-08223	15929	171	1H0-867-199-A	21482	688
90269-A0005	21315	260	90467-08195	21847	NI 28	90982-09019	21602	172	1H0-868-243	21393	403
90269-A0006	20788	253	90467-08196	21846	NI 28	90982-09025	21604	172	1H0-868-243-B	21415	403
90341-12012	21293	223	90467-09004	19112	385	93904-46320	16960	36	1H5-863-849-A-01C	21145	687
90430-12018	22134	NI 4	90467-09004-01	19112	385	95900-04036	17224	663	1J6-867-276	22116	NI 31
90430-12019	17628	222	90467-09006	18842	385	VOLKSWAGEN (Includes Audi)					
90430-12027	22134	NI 4	90467-09008	14738	385	N-014-389-3	13173	684	2D1867741	21843	NI 22
90430-12028	17628	222	90467-09008-01	14738	385	N0385491	19195	687	321-837-581-01C	14194	689
90430-12031	22134	NI 4	90467-09050	19729	384	N0385501	21391	687	333-867-633-4FB	21451	687
90430-C0005	22134	NI 4	90467-09065-B1	16781	384	N-102-593-01	20187	628	357-827-998	20933	685
90463-10337	14284	680	90467-09069-01	21821	NI 29	N-103-201-01	16897	203	357-853-575	21509	387
90467-04034	21552	380	90467-09093	17439	613	N10320102	16897	203	357-853-585-A	21496	387
90467-05020-01	19506	367	90467-09096	19219	678	N10475903	B3357A	206	357-853-586-D	20250	685
90467-05045-22	19686	365	90467-09127	19739	678	N10721801	BD2C	208	3A0-853-575	21478	684
90467-05063-CO	21218	675	90467-09139	19416	677	N10724401	B7440A	206	3A0-853-575-A	21448	683
90467-05081	21615	681	90467-09143	17988	613	N10724402	B7440	206	3B0-853-575	21449	683
90467-05090-B1	21103	675	90467-09145	17206	676	N14-4003	11404	41	3B0-853-576	21447	683
90467-05096-22	19312	367	90467-09166	21010	678	N185101	11101	230	3B0-868-243	20341	402
90467-05114	20956	681	90467-09185	21547	677	N185112	11099	230	3C0-853-585	21761	NI 31
90467-05128	21614	681	90467-09204	21546	657	N185151	11097	230	441863987B	21485	688
90467-05136	21849	NI 30	90467-09206	20437	395	N185161	11098	230	443-853-909-A	21491	683
90467-05138	21687	NI 31	90467-09212	21410	392	N185301	11100	230	4A0-805-121-A	21515	685
90467-05164-B6	21253	368	90467-09227	21366	678	N-900-845-01	17006	256	4A0-853-825	21492	683
90467-05164-E2	21332	368	90467-10018	14347	386	N90100001	12595	64	4A0-853-825-A	21493	682
90467-05170	22125	NI 30	90467-10077	19797	658	N90100001	16268	64	4A0-853-825-C	21481	683
90467-06017	14260	676	90467-10096	19534	667	N90168602	22113	NI 3	4A0-867-276A	22108	NI 33
90467-06017-41	14260	676	90467-10107	19123	384	N90229301	22095	NI 32	4D0-807-300	22101	NI 32
90467-06017-CO	14260	676	90467-10123	19014	383	N90288901	21352	224	4F0-805-163	22098	NI 31
90467-06128	21626	383	90467-10146	19728	382	N90-335-006	21513	688	4L0-886-373	22094	NI 33
90467-06133-CO	20196	675	90467-10161	18876	396	N-904-374-01	20830	256	6K0-868-243-C	21398	403
90467-06138	19720	382	90467-10162	18861	387	N90561601	18661	203	6N0-809-966A	21816	NI 35
90467-06150	19490	676	90467-10167	20559	393	N90561601	20601	204	6N0-823-397-AC	21514	688
90467-06161-01	14736	383	90467-10168	18950	395	N90565301	21842	NI 32	6Q0-868-243	21251	688
90467-06175	21560	368	90467-10170-CO	21702	NI 30	N-906-349-01	17006	256	6Q0-868-246-A	21760	NI 32
90467-07041	17162	487	90467-10173	19123	384	N906-420-01	21842	NI 32	6Q0-868-297	21783	NI 32
90467-07041-B2	17162	487	90467-10183	20869	676	N90775001	22111	NI 2	701-867-299	21479	687
90467-07041-CO	17162	487	90467-10186	21634	384	N90775801	22110	NI 2	703-867-299	21450	388
90467-07042-CO	21560	368	90467-10188	20633	395	N90-796-501	21485	688	7L0-839-069	21512	683
90467-07043	16784	677	90467-10206	21624	676	N90-796-502	21485	688	7L5-853-994	21495	387
90467-07043-11	16784	677	90467-11063	17481	658	N908-131-01	21817	NI 35	7L6-868-243	21708	NI 32
90467-07043-CO	16784	677	90467-11099	21550	658	N-908132-01	20746	225	7M0-867-299-K	21853	NI 32
90467-07044	19128	678	90467-11100	20429	658	N90813202	20746	225	7M3867299	21853	NI 32
90467-07050	14737	383	90467-11111	19647	658	N908-214-01	20925	685	801-853-577	12635	682
90467-07059-22	19013	676	90467-11117	22051	NI 29	N908-338-01	20924	684	801-867-299-01C	21758	NI 32
90467-07066	17383	486	90467-12073	21641	659	N90892001	22111	NI 2	803-853-139A	13189	682
90467-07066-J0	17383	486	90467-12075	21642	660	N91167901	21798	NI 4	803-853-139C	13174	682
90467-07071-22	21249	675	90467-12078	16779	386	N989022	11351	373	811-807-557-C	21510	684
90467-07076-CO	17162	487	90467-12078-01	16779	386	N989-051-01	11678	401	811-807-577-C	21399	685
90467-07096	19124	386	90467-12080	21549	657	Q28-103-059-A	21041	226	823-867-299	20252	400
90467-07121	19908	677	90467-12096	14277	664	06L-103-801	22143	NI 4	867-809-966	21510	684
90467-07121-B2	19907	677	90467-13005	17194	657	111-837-5815	13031	689	8E0-867-276	21252	387
90467-07126	19535	667	90467-13011	17195	632	111-837-581J	13031	689	8E0-868-243	21144	403
90467-07138	17992	613	90467-13075	21623	657	113-853-585C	13229	682	VOLVO		
90467-07138-CO	17992	613	90467-17004	17438	657	113-853-615A	13227	67	1201-930	13195	689
90467-07146	19552	676	90467-A0003	19113	384	113-857-219A	13206	685	1-246-926	14212	690
90467-07164	20908	678	90467-A0003	19729	384	131-853-585C	10322	682	1-246-993	14209	690
90467-07166	18888	678	90467-A0005	20437	395	155-809-966	12735	466	1-255-551	14211	689
90467-07168	20577	677	90467-A0005	21102	395	161-867-299-01C	19195	687	1-255-553	14210	690
90467-07168-C1	20577	677	90467-A0006	18876	396	165-827-592	21480	684	1268176	19248	690
90467-07188	21011	676	90467-A0008	20878	371	171-201-969	21456	689	1268642	21859	NI 22
90467-07190-B2	21104	675	90467-A0018	21615	681	171-807-249-A	21494	400	30624192	21785	NI 33
90467-07192	21120	676	90468-04030	16671	680	175-820-435	16252	99	30653441	21786	NI 33
90467-07201	20955	678	90468-04038	16306	680	175-853-577-01C	13748	245	30753487	22138	NI 33
90467-07211	21201	614	90520-01002	2288	346	175-853-577A	13753	246	30753556	22137	NI 33
90467-07214	21294	678	90520-01274	2288	346	175-853-673	14013	483	30784514	21784	NI 33
90467-08004	18297	383	90904-67021	19430	657	175-853-674	14014	466	3104-426	13173	684
90467-08008	14737	383	90904-67036	20390	658	175-867-299	13475	400	591-740	12637	689
90467-08011	18297	383	90904-67037	20391	658	176-941-117A	15666	682	680-097	13191	690
90467-08011-83	18297	383	90950-01248	16777	385	179-813-881	14030	466	9133073	20407	690
90467-08014	19121	371	90950-01620	22097	NI 31	191-853-577	21508	682	9133417	21859	NI 22
90467-08014-01	19121	371	90950-08004	22159	NI 29	191-853-577-A	21390	682	9133417-7	19904	690
90467-08045	21695	NI 29	90959-01136	17631	679	191-853-733-A	21416	682	9151649	20405	689
90467-08063	21695	NI 29	90981-13018	20600	204	191-941-142	21498	684	946-418	13220	69
90467-08081	18878	384	9098113046	B9005	208	1H0-819-055-B01C	21392	372	947-098	13230	628
90467-08101	21643	383	90981-13046	16897	203	1H0-819-055-C01C	21452	688	979878-6	19376	256
90467-08122	19122	384	9098113047	B9006	208	1H0-823-397	21483	688	980557	B3357	206
90467-08124	19113	384	90981-13055	18661	203	1H0-837-719	21497	385			
90467-08136	21254	386	90981-13055	20601	204	1H0-853-585	21394	683			

O.E.M. INTERCHANGE BY NUMERICAL ORDER

The O.E.M. numbers listed in this interchange are cross referenced to the closest equivalent Auveco part. In some instances, the parts are not identically the same. There may be slight differences in the finished, length, washer O.D.: however, the Auveco part is designed to service the same application.

This interchange is not listed in strict numerical order (from the lowest number to the highest number.) Rather it is arranged in numerically ascending order from the left regardless of the number of digits in each O.E.M. number. Thus every number that begins with a 1 is listed before any number that begins with a 2. You should key on the first four digits to locate the number. For example, 1121865 is located before 11229 and after 11189734. OEM numbers that begin with a letter precede OEM numbers that begin with a numeral.

O.E.M. No.	Auveco No.	Page No.	O.E.M. No.	Auveco No.	Page No.	O.E.M. No.	Auveco No.	Page No.	O.E.M. No.	Auveco No.	Page No.
A20Z-13410B	13537	184	AD64BS	8307	240	D0ZB-13A-093AA	11660	512	E1ZE-9E499-CA	18836	133
A901-988-00-25	21843	NI 22	AD66-68BS	19029	244	D1AB-14461-AA	14887	156	E1ZE-9E499-EA	18835	132
AB009006	16898	203	AD66-68BSLF	19037	244	D1AB-6542413-AB	9882	349	E25Y-14421-C	16342	156
AB-181-GG	16893	52	AD66ABS	8301	240	D1AZ-13410-A	19813	192	E25Y-14421-CA	16342	156
AB3-2A	19053	240	AD66ABSFL	8313	240	D1AZ-13410B	13537	184	E2EB-6120C62-AA	19154	517
AB4-2	8905	240	AD66BS	8297	240	D1AZ-6522841A	14550	509	E2EB-61290C62-AA	19154	517
AB4-2A	8309	240	AD68-612BS	19030	244	D1AZ-6542413-B	9882	349	E2GZ-6723342-A	13030	534
AB4-4	8911	240	AD68ABS	8938	240	D1FZ-13234-A	14135	185	E35Y-13466-A	20294	202
AB4-4A	8925	240	AD68ABSFL	19056	240	D1FZ-13466-B	16913	201	E35Y-13466-B	18012	201
AB4-6A	16031	240	AD68BSLF	19051	240	D1FZ-6222600-A	12470	534	E3MY-13466-A	18006	201
AB4-8	19049	240	AD82-86BS	19031	244	D1S	BD1S	208	E3MY-13466-A	20291	202
AB4-8A	16032	240	AD8375UG	17423	250	D2AZ-6522008-A	18892	533	E3MY-13466-A	20711	210
AB5-2A	18727	240	AD8625UGX	17424	250	D2C	BD2C	208	E3SB-6342413-AB	13564	349
AB5-3A	18728	240	AD86ABS	19058	240	D2FZ-6222600-A	12470	534	E3TB-1063-226AA	16213	461
AB5-4	19050	240	AK42ABS	8299	240	D2OB-13A093-AA	11660	512	E3VB14461AA	18853	156
AB5-4A	18729	240	AK42BS	8908	240	D2OB-13A093-AA	11661	512	E3VB-144861-AA	18853	156
AB5-6A	18730	240	AK44ABS	8928	240	D2OB-14421-BB	20815	156	E4FZ-8C290-A	17619	190
AB5-8A	18731	240	AK44BS	8914	240	D2R	BD2R	209	E5AZ-13466-A	18476	201
AB6-10A	18489	240	B001-68-302-00	16777	385	D2S	BD2S	209	E5LY-13N021-A	16896	203
AB6-2	8295	240	B003-68-865-00	21755	NI 21	D3AA-90826-AA	10837	529	E5LY-13N021-A	B9004	208
AB6-2A	5755	240	B003-68-865-96	17453	367	D3AB-14474-DA	14889	156	E5ZZ-12A209-A	18217	188
AB6-4	8307	240	B092-50-609	17290	616	D3AZ-13410-A	13535	184	E6AZ-5421952-A	15675	532
AB6-4A	8311	240	B092-50-715	17195	632	D3AZ-13410-B	13533	184	E6DZ-13032-A	15968	511
AB6-6	8297	240	B092-51-833	17632	523	D3AZ-13410-E	14131	185	E6DZ-13466-B	18005	201
AB6-6A	8301	240	B100-68-675-69	21119	439	D3AZ-13410-G	14132	185	E6DZ-13466-B	B916A	206
AB6-8A	8938	240	B100-68-8550	21110	622	D3AZ-14474-G	20816	156	E6DZ-13K040-B	15634	512
AB8-6A	19058	240	B101-68-252-00	17478	622	D3AZ-14526-D	12629	163	E6DZ-14A411-A	18676	188
ABL4-2A	8922	240	B173-50-852A	19451	616	D3AZ-14526-D	15372	163	E6DZ-5421952A	17122	532
ABL4-4A	8931	240	B27K-51-PS7	22049	NI 22	D3AZ-14526-E	12628	163	E6DZ-5421970-A	17119	531
ABL4-8A	20474	240	B455-56-135	21862	NI 22	D3AZ-14526-H	12628	163	E6DZ-5421971-A	17118	531
ABL6-10A	19057	240	B455-56-741	18458	385	D3AZ-14526-J	12629	163	E6FZ-13466-B	18016	201
ABL6-4A	19055	240	B467-68-AC3-02	21858	NI 22	D3AZ-14526-Z	12627	163	E7EB-14421-EA	16342	156
ABL6-6A	8313	240	B5A-10756-B	8964	722	D30Z-16776-A	11136	382	E7EB-14461-BA	20475	156
ABL6-8	19051	240	B5AZ-13466-A	B89	206	D42B-6021066-BA	14213	518	E7EB-14474-CA	16344	156
ABL6-8A	19056	240	B7A-16758-A	4273	339	D4AZ-13466-A	18465	201	E7GZ-17A904-B	15366	623
AC4-2	8908	240	B8AZ-13466-A	16919	201	D4LY-13410-A	14133	184	E7GZ-6120586-B	18692	381
AC4-2A	8299	240	BBM450355	20971	255	D4MY-13466-A	18011	201	E7SB-13A093BA	15966	511
AC4-4	8914	240	BC1D-56-145	19315	623	D4OZ-13234-A	14128	185	E7SZ-13032-D	15966	511
AC4-4A	8928	240	BC1M-50-0Z5	20984	617	D4ZZ-13234-A	14130	185	E7ZZ-13466-B	18007	201
AD32ABS	19053	240	BC3Z-6730-A	21665	223	D5AB-14474-FA	20816	156	E7ZZ-13466-B	20712	210
AD41-43BSLF	19033	244	BF67-50-033	15366	623	D5ZZ-16828A	17338	529	E804-14526A	15926	171
AD42ABS	8309	240	BF67-50-235	17450	623	D6EA-1A100-AA	11702	414	E804-14526B	15927	171
AD42ABSFL	8922	240	BF82-50-233	16843	623	D6TZ-6730-A	14196	223	E804-14526D	15931	171
AD42BS	8905	240	BP4K-58-762	21307	385	D7TZ-13466-A	18008	201	E83B-13A093-AA	16733	511
AD43-45BS	19025	244	BP4L-51-SJ3	21171	616	D7TZ-13466-A	20710	210	E83Z-16758-A	16832	340
AD43-45BSLF	19034	244	BSS800	12654	260	D7TZ-13466-A	B912	206	E83Z-5421952-B	17122	532
AD44ABS	8925	240	BW0A-50-792	19138	619	D7VY-6050074-A	13966	100	E8AZ-13466-A	17996	201
AD44ABSFL	8931	240	C0AZ-1012-A	8744	85	D8BB-14474-BA	14889	156	E8BZ-17C756-C	17450	623
AD44BS	8911	240	C1AB-6220807-A	3639	382	D8BZ-13466-A	16922	201	E8EB-13A093AA	16396	511
AD45-47BS	19026	244	C1SF-14474-A	15504	157	D8BZ-13466-A	B906	206	E8EB-13A093AB	16396	511
AD46ABS	16031	240	C2AZ-13466-C	16902	201	D8BZ-14474-A	14889	156	E8EB-13A093BA	16397	512
AD48ABS	16032	240	C2AZ-13466-C	B194	206	D8BZ-5423342-A	13030	534	E8EB-14474-VA	16348	156
AD48BS	19049	240	C2D5807	22157	NI 20	D8TZ-13466-A	18472	201	E8FZ-13032-A	16396	511
AD52-54BS	18743	244	C2TB-14462-A	17115	157	D8TZ-6730-A	19365	227	E8FZ-13032-B	16397	512
AD52-54BSLF	17468	256	C3AZ-13466-D	20285	202	D9OZ-6522841A	14551	533	E8FZ-5802354-A	19845	375
AD52ABS	18727	240	C3DZ-13466-A	16904	201	D9AB-74519B18-AA	14758	402	E92Z-17C756-C	17060	623
AD53-55BS	19027	244	C3DZ-13466-A	B1156	206	D9AE-9E645-AA	12921	132	E97B-13A093BA	16399	511
AD53ABS	18728	240	C5AB-14474-B	14892	157	D9AZ-14474-F	16344	156	E97B-13A093BB	16399	511
AD54ABS	18729	240	C5AB-6220586-A	8853	380	D9AZ-14A163-J	12622	528	E9AZ-5422008-A	18891	532
AD54ABSFL	18732	240	C5AZ-6243720-B	4750	337	D9ZZ-6643030-AA	19594	533	E9DB-13N020AA	15940	512
AD54BS	19050	240	C5ZZ-6543413-B	8941	349	DG9Z-14526-N	21749	NI 3	E9DZ-13N129-A	15940	512
AD56ABS	18730	240	C60Z-16758-A	4357	339	DG9Z-14526-P	21751	NI 3	E9DZ-6730-B	18025	225
AD58ABS	18731	240	C6AB-6242413-A	9353	349	DG9Z-14526-R	21752	NI 3	E9DZ-6730-B	19773	225
AD610ABS	18489	240	C7SZ-13466-B	16921	201	DG9Z-14526-S	21750	NI 3	E9DZ-6734B	18299	222
AD610ABSFL	19057	240	C7SZ-13466-B	20706	210	DKP5279L	22093	NI 21	E9FZ-5822008-A	18890	532
AD62-64BS	18744	244	C7SZ-13466-B	B168	206	DYC000091	22151	NI 20	E9SB-13N019-BA	16425	513
AD62-64BSLF	19036	244	C80Z-13711A	12237	174	DYC000122	22145	NI 20	E9SB-6302354ACW	15523	373
AD6270UG	17421	250	C8AB-14463-M	18451	157	DYC101420	21657	607	E9SZ-13N019-B	16425	513
AD62ABS	5755	240	C8AZ-63442413-A	9882	349	DYC500020	21853	NI 32	E9SZ-13N021-A	16898	203
AD62BS	8295	240	C8AZ-63642413-A	9882	349	E0TB-1063-226AC	16213	461	E9SZ-13N021-B	16897	203
AD63-66BS	19028	244	C8TZ-13466-A	16899	201	E0VE9K319AB	12938	132	E9TZ-13032B	16399	511
AD6437UGX	17422	250	C8TZ-13466-A	B1157	206	E11451W24	21561	616	E9TZ-6730-B	19365	227
AD64ABS	8311	240	D0AZ-62234A2-B	17974	353	E1EB-61046A48-BA	12606	530	EA01-50-037	21663	621
AD64ABSFL	19055	240	D0DZ-15A434-B	9883	174	E1EZ-9E499-EA	18835	132	EA01-50-048	18882	616

O.E.M. INTERCHANGE BY NUMERICAL ORDER

O.E.M. No.	Auveco No.	Page No.	O.E.M. No.	Auveco No.	Page No.	O.E.M. No.	Auveco No.	Page No.	O.E.M. No.	Auveco No.	Page No.
EOSZ-13466-A	20291	202	GJ21-51-036	16555	615	L0003457	B3457	206	MR201466	19328	635
EOVY-13A506-A	17164	528	GJ21-58-502A	19743	618	L0007440	B7440	206	MR221507	21623	657
F03Z-13032-A	16733	511	GJ21-58885-A69	18206	622	L0007440NA	B7440A	206	MR288150	21658	634
F0TZ-14489-J	19004	193	GJ21-68-885B-02	21024	525	L0007443	B7443	206	MR322000	21690	NI 23
F1CZ-13466-C	20595	203	GJ21-68885-B69	18206	622	L0009004LL	B9004	208	MR435918	20571	387
F1CZ-13A147-A	18899	512	GJ6A-50-ES1	21304	516	L0009005	B6897	203	MR478262	20580	543
F1CZ-16774-A	18458	385	GJ6A-58-975	21743	NI 21	L0009005	B9005	208	MR478263	20581	538
F1CZ-5802316-A	19138	619	GJ6A-68-162	20958	617	L0009006	B6898	203	MR587315	21073	562
F1CZ-61101B04-A	17602	521	GJ6E-50-715-A	20923	522	L0009006	B9006	208	MS452348	21744	NI 2
F1CZ-8A188-A	17317	516	GJ6R-68-ABX	20983	393	L0009006XS	B6898	203	MS480001	14255	585
F1TZ-17698-A	19393	352	GK2A-50-798	21300	515	L0009007QL	B8662	203	MS480002	13932	663
F1TZ-7810182-A	19441	520	GM9E-63-938A	20960	617	L0009007QL	B9007	208	MS480009	13932	663
F1ZZ-13466-A	20286	202	GS3L-68-615	21413	618	L0009107	BH10	209	MS480012	14695	587
F2Z2-16774-A	14709	367	H001-50-609	14719	616	L000921E	B921	206	MS820959	16897	203
F2DZ-13466-C	20599	204	H001-50-841	14695	587	L00194NA	B194A	206	MU000319	19239	594
F2PZ-14A464-C	19004	193	H001-68-719B	17451	619	L002057A	B2057A	206	MU435004	16254	99
F2UZ-1602354-AAA	19846	375	H0564-7Y000	21042	562	L004157NAK	B4157K	206	MU435004	16254	99
F3Z2-17C756-S	17003	625	H0564-7Y010	21042	562	L00H355W	20600	204	MU480001	21632	535
F3TZ-13N129-A	18263	513	H1	BH1	209	L562	20402	252	MU480034	19322	633
F3DZ-6730-A	18025	225	H10	BH10	209	L891	20598	204	MU481027	19325	380
F3DZ-6734-A	18299	222	H11	BH11	209	LA01-50-6A8A	19831	617	MU481187	19323	384
F3LY-14570-B	17222	488	H115-67-099	15926	171	LA01-56-135	14750	680	MU840004	15931	171
F3LY-6321970-A	17119	531	H116-67-099	15927	171	LB82-50-669A	19755	616	MU840015	15926	171
F3LY-6321971-A	17118	531	H117-67-099	15931	171	LR000080	22148	NI 20	MU840016	15927	171
F4CZ-13466-A	16917	201	H13	BH13	209	LR002229	22150	NI 20	MU840021	15931	171
F4CZ-13466-A	B3157	206	H260-50-6K8	22064	NI 21	LR027255	22149	NI 21	MWC3136	22085	NI 20
F4PZ-14A411-C	19885	193	H3	BH3	209	LR028939	22152	NI 21	MWC9134	21770	NI 20
F4TZ-13N021-B	18662	203	H3	20600	204	LR032984	22153	NI 21	MXC1800	21855	NI 20
F4TZ-13N021-B	B9007	208	H4	20601	204	LR033144	22155	NI 21	N-014-389-3	13173	684
F4UB-14A464-A	19004	193	H7	BH7	209	LS101	9883	174	N0385491	19195	687
F4VY-14A411-S	20846	192	H9	BH9	209	MB020923	19385	384	N038-550-1	21391	687
F4XY-6734-A	21258	222	HB1	B9004	208	MB020923	19385	384	N-102-593-01	20187	628
F4ZZ-6310182-A	20965	520	HB1	16896	203	MB023930	14366	618	N-103-201-01	16897	203
F50Y-14603-A	21224	515	HB121467	14720	386	MB029111	14277	664	N10320102	16897	203
F54Y-13466-A	19209	204	HB2	18661	203	MB098145	14275	665	N10475903	B3357A	206
F54Y-13466-A	20717	211	HB3	B9005	208	MB106212	14335	640	N10721801	BD2C	208
F57B-16241-AA	21000	520	HB3	16897	203	MB132008	14335	640	N10724401	B7440A	206
F57Z-16241-AB	20663	520	HB4	B9006	208	MB132008	14335	640	N10724402	B7440	206
F57Z-7810182-AAA	19441	520	HB4	16898	203	MB153825	17195	632	N14-4003	11404	41
F58Z-16237A02-A	18848	389	HB5	B9007	208	MB153825	17195	632	N185101	11101	230
F5DZ-13466-B	17996	201	HB5	18662	203	MB253964	17351	635	N185112	11099	230
F5DZ-13466-B	B3156	206	HG30-50-6B9A	19648	617	MB253964	17351	635	N185151	11097	230
F5RZ-17K657-A	20425	514	HP-2	7915	241	MB271999	20565	633	N185161	11098	230
F5RZ-5421416-B	19281	513	HP-30A	7982	241	MB325299	16671	680	N185301	11100	230
F5RZ-6730-B	18374	224	HP-30B	7983	241	MB325299	16671	680	N304-13-356A	14697	595
F5TZ-6734-BA	20453	222	HP-30C	7984	241	MB358818	15926	171	N605774-S2	12338	52
F65Z-15020C34-AA	19536	529	HP-30D	7985	241	MB358819	15927	171	N605920-S2	12327	54
F65Z-15020X34-AA	19536	529	HP-30N	7981	241	MB374270	21118	396	N606676-S100	12160	51
F67Z-7822008-AA	18890	532	IPN500050	22156	NI 21	MB374271	21118	396	N606676-S100	15778	51
F6DZ-5402316-AA	19238	516	J001-56-741	21520	385	MB383455	14331	639	N606676-S2	12160	51
F6DZ-5403296-A	20942	345	J0Y1-50-619C	19452	617	MB419858	19487	632	N606676-S36	15778	51
F6DZ-5410182-AA	20358	520	J4004175	9298	82	MB455-56143	17632	523	N606677-S36	12335	52
F6TZ-6730-BA	19279	225	J4004354	9297	82	MB547806	17472	647	N606677-S43B	15779	52
F75Z-6730-BA	18025	225	J4004354	10087	82	MB547806	17472	647	N606677-S53B	15779	52
F75Z-6730-BA	19773	225	J4005293	10087	82	MB566719	19802	389	N606690-S2	15780	53
F79Z-1123342-AAA	13030	534	J4006956	18163	85	MB566720	19334	388	N606690-S55	15780	53
F7CZ-17C756-BA	20336	515	KA01-50-H15A	17554	517	MB566720	19334	388	N606692-S2	16931	53
F7DZ-5402316-AA	19238	516	KA01-50-H16	17553	517	MB608104	19129	398	N610959-S2	13019	61
F7UZ-1513284-BA	19421	530	KA80-51PR6	18882	616	MB608104	19129	398	N620391-S36	17495	65
F7UZ-15238A32-AAC	19413	521	L0000067	B67	206	MB608137	19343	631	N620480	15316	64
F81Z-19D887-AA	20843	190	L0000089	B89	206	MB608140	19330	632	N620480-S2A	15316	64
F81Z-6730-AA	20807	223	L0000168	20706	210	MB608156	19475	632	N620482	15318	64
F8DZ-54265A99-AA	20630	532	L0000168	B168	206	MB619582	21140	635	N621900	15325	64
FB01-56-964	16000	596	L0000194	B194	206	MB645307	21025	537	N621903	15326	64
FD02-50-798	20579	618	L0000880	B880	207	MB655630	22082	NI 23	N621905	15328	64
FDA13021-A	12228	512	L0000886	B886	207	MB696120	19320	387	N621906-S361	16774	64
G030-68-885-B-38	14709	367	L0000891	B891	207	MB696120	19320	387	N621906-S437	16774	64
G031-58-762	18692	381	L0000894	B894	208	MB814419	19314	632	N621907	15332	64
G032-68-865A-00	21560	368	L0000896	B896	208	MB817060	20573	633	N621940-S424	15335	64
G043-50-742	20460	387	L0000899	B899	208	MB846992	20572	632	N621942-S301	15337	64
G14S-50-EA1	21769	NI 22	L0000906	B906	206	MB869072	19331	383	N621942-S441	15337	64
G18K-51-SJ3	20932	388	L0000912	B912	206	MB879499	22077	NI 23	N621945-S2	21001	64
G350-68-AB1	18824	392	L0000H11	BH11	209	MB880455	19745	632	N623330-S2	18337	107
G6JA-50-025	20957	617	L0000H13	BH13	209	MB887567	17351	635	N623331-S2	18338	107
GA2A-56-399A	19753	619	L0001156	B1156	206	MB888561	19324	633	N623332-S21	12669	108
GA2A-56-694	14709	367	L0001157	B1157	206	MB888869	19140	635	N623332-S439	12669	108
GA2A-58-762	19481	380	L0001893	B1893	206	MC440901	20381	384	N623332-S53	12669	108
GA2A-68-AB1A	20459	392	L0001895	B1895	206	MD050317	19007	222	N623333-S100	11629	109
GA5R-56-392	19306	622	L0002057	B2057	206	MF453091	21746	NI 2	N623333-S2	11629	109
GD7A-50-EA1	20755	623	L0003057	20722	210	MNA01-56145	16858	646	N623340-S2	11625	107
GJ21-50-034	17060	623	L0003057	B3057	206	MR138807	18951	635	N623343-S100	11630	109
GJ21-50-049	17003	625	L0003156	B3156	206	MR154128	19474	632	N623343-S2	11630	109
GJ21-50-H81	17551	516	L0003157	B3157	206	MR200300	20247	594	N623344-S2	18339	109
GJ21-50-H82	17552	516	L0003157AK	B3157A	206	MR200300	20247	594	N800312-S2	15776	60

O.E.M. INTERCHANGE BY NUMERICAL ORDER

O.E.M. No.	Auveco No.	Page No.	O.E.M. No.	Auveco No.	Page No.	O.E.M. No.	Auveco No.	Page No.	O.E.M. No.	Auveco No.	Page No.
N800369	16422	35	N806289-S	17339	381	N908-214-01	20925	685	W-159	15004	86
N800369-S2	16421	35	N806322-S	18893	523	N908-338-01	20924	684	W-246	15018	87
N800387-S	11842	376	N806334-S	20245	513	N90892001	22111	NI 2	W-486	15009	86
N800466	15325	64	N806340-S	19850	380	N91167901	21798	NI 4	W-487	15010	86
N800484-S58	16736	1	N806344-S	18275	375	N989022	11351	373	W520821-S426	18338	107
N800503-S	11841	515	N806363-S	20264	515	N989-051-01	11678	401	W520821-S439	18338	107
N800510-S100	20176	51	N806511-32	19823	530	NA01-50-101A	19228	615	W520822-S426	12669	108
N800540-S100	20176	51	N806511-S32	19823	530	NA01-56-145	16858	646	W520823-S426	11629	109
N800854-S2	18449	108	N806511-S441	19823	530	NA01-56145	16858	646	W520823-S439	11629	109
N800947-S	16893	52	N806624-S191	18102	529	NE51-51-SJ3A	21678	NI 21	W520832-S424	12575	108
N801117-S100	18401	109	N806830-S100	17639	261	OH452KD5	17080	543	W520832-S426	12575	108
N801169-S900	22104	NI 1	N806830-S100	19263	261	OWX68BD1-AA	20948	543	W525170-S	19462	251
N801310	15317	64	N806959-S	19235	331	OWX68BD5-AA	21021	543	W525170-S417	19414	251
N801603-S2	20271	59	N807154-S	19371	371	PR2	16927	201	W525172-S300	19110	251
N801706-S	12569	514	N807154-S	19373	371	PT516	13547	182	W525172-S417	19461	251
N801925-S	12565	389	N807155-S	19352	370	PT549	11440	182	W525174-S	19420	252
N801994-S100	19667	368	N807155-S	19354	370	R4357	11104	253	W525174-S300	19420	252
N802239-S	17643	528	N807168-S	19111	259	S084-58-502	20463	619	W525175-S300	19456	252
N802241-S	17642	528	N807189-S100	20171	516	S51S-51-833	21662	621	W-6	15017	87
N802331-S53	16842	108	N807247-S	19526	517	SB3-2	19044	239	W700566-S300	18383	514
N802376-S	14754	514	N807389-S	17216	491	SB3-4	19045	239	W700614-S300	18498	520
N802538-S100	14526	104	N807535-S	19760	372	SB4-1	19046	239	W700671-S300	20319	372
N802734-S	15480	373	N807577-S	18895	523	SB4-2	5749	239	W701054-S300	18503	527
N802734-S	19197	373	N807578-S	18894	523	SB4-3	8874	239	W701133-S300	18386	528
N802737-S	13469	524	N807620-S100	18461	255	SB4-4	5753	239	W701223-S300	20194	521
N802775-S36	16883	64	N807673-S	22058	NI 12	SB4-6	8880	239	W701259-S300	10831	371
N802781-S	14020	526	N807706-S	19326	514	SB4-8	19047	239	W701374-S	20399	367
N802900-S	12565	389	N807721-S	17612	371	SB5-2	8883	239	W701380-SSW	18379	369
N802900-S	13470	389	N807875-S	19524	403	SB5-4	8886	239	W701430-S300	18377	518
N803043-S	13750	246	N807943-S	19810	389	SB6-10	8902	239	W701566-S417	18331	261
N803170-S	14021	365	N807951-S	18820	368	SB6-2	8889	239	W701649-S	19237	30
N803183-S32	14814	102	N807994-S	18816	517	SB6-4	8892	239	W701855-S300	20366	370
N803362-S	13993	489	N808041-S437	20742	500	SB6-6	8895	239	W701971-S	20169	527
N803387-S	15668	377	N808048-S	16726	525	SB6-8	8899	239	W701971-S	20169	527
N803387-S300	15668	377	N808147-S	14991	485	SBL4-2	8291	239	W701993-S	17604	331
N803421-S	14019	526	N808182-S309	19436	531	SBL4-4	8293	239	W702010-S300	19532	379
N803494-S	14953	522	N808182-S439	19436	531	SBL6-12	18814	239	W702380-S300	18504	529
N803613-S	16863	377	N808331-S	18895	523	SBL6-4	18811	239	W702412-S300	19345	521
N803638-S36B	14895	530	N808332-S	18894	523	SBL6-6	8305	239	W702512-S900C	22023	NI 5
N803685-S11	14820	500	N808342-S307	20546	530	SBL6-8	18812	239	W702554-S900C	22066	NI 5
N803709-S	17103	488	N808370-S	19127	372	SC4-2	5751	239	W702926-S	18744	244
N803716-S	14018	526	N808594-S100	18396	252	SC4-4	8303	239	W703842-S300	20193	521
N803734-S	15480	373	N808689-S417	19458	253	SD32BS	19044	239	W703919-S300	20193	521
N803739-S	22139	NI 6	N808791	20273	524	SD34BS	19045	239	W704340-S300	14020	526
N803763-S100	20415	501	N808842-S	19338	376	SD41BS	19046	239	W704881-S300	19237	30
N803768-S	18155	513	N808847-S	19244	526	SD42BS	5749	239	W704958-S300	19511	527
N803857-S	20311	366	N808908-S	19337	527	SD42BSLF	8291	239	W705002-S300	19338	376
N803862-S	13751	246	N811006-S	18936	402	SD43BS	8874	239	W705297-S300	21245	260
N803933-S101	17408	253	N811018-S100	17639	261	SD44BS	5753	239	W705376-S900	17420	250
N803946-S	14992	522	N811018-S100	19263	261	SD44BSLF	8293	239	W705436-S300	19801	489
N803968-S100	14819	530	N811040-S	20893	366	SD46BS	8880	239	W705532-S300	16726	525
N804189-S	13747	245	N811169-S	19783	517	SD48BS	19047	239	W705550-S300	19783	517
N804193-S100	18167	252	N811257-S100	20421	530	SD52BS	8883	239	W705589-S	11146	371
N804343-S	13748	245	N811257-S309	20421	530	SD54BS	8886	239	W705589-S	15414	371
N804344-S	14967	548	N811259-S	18812	239	SD610BS	8902	239	W705589-S300	11146	371
N804349-S	15479	375	N811283-S	20545	523	SD612BSLF	18814	239	W705590-S300	20466	468
N804379-S	15478	374	N811353-S100	20171	516	SD6270UG	17425	250	W705711-S417	19414	251
N804448	14757	368	N811460-S100	19419	255	SD62BS	8889	239	W705845-S300	17632	523
N804570-S	14753	485	N811478-S100	20927	39	SD64BS	8892	239	W705848-S300	14753	485
N804570-S	14993	486	N811534-S61	19653	60	SD64BSLF	18811	239	W705849-S300	20355	521
N804583-S	15187	245	N811540-S	20360	372	SD66BS	8895	239	W705955-S300	20177	370
N804614-S	13994	492	N811772-S	19472	495	SD66BSLF	8305	239	W705956-S300	20233	524
N804674-S	15701	526	N-900-845-01	17006	256	SD68BS	8899	239	W705957-S300	20518	527
N804675-S	17101	246	N90100001	12595	64	SD68BSLF	18812	239	W706092-S300	21098	523
N804759-S	15491	246	N90100001	16268	64	SD816BS	19048	239	W706172-S309	20401	531
N804765-S	19277	514	N90168602	22113	NI 3	SD8375UG	17427	250	W706182-S300	20516	525
N804837-S	14994	524	N90-229-301	22095	NI 32	SD8625UGX	17428	250	W706350-S300	14992	522
N804851-S100	19516	261	N90288901	21352	224	SK42BS	5751	239	W706358-S300	15478	374
N804992-S58	10654	4	N90-335-006	21513	688	SK44BS	8303	239	W706494-S300	19849	524
N805026S	14995	485	N-904-374-01	20830	256	SSB4-4S	19060	240	W706519-S300	20518	527
N805083-C	16832	340	N905150-S	17466	259	SSB6-8S	19061	240	W706575-S300	20393	514
N805155-S	17124	389	N90561601	18661	203	SSBN4-3	11104	253	W706635-SSW	21241	375
N805229-S	14988	522	N90561601	20601	204	SSC42	5750	239	W706713-S300	20367	523
N805231S	15522	524	N90565301	21842	NI 32	SSD44SSBS	19060	240	W706815-S300	21257	372
N805315	17381	376	N-906-349-01	17006	256	SSD6270UG	17429	250	W707157-S300	20245	513
N805350-S	20675	548	N906-420-01	21842	NI 32	SSD68SSBS	19061	240	W707388-S300	20936	521
N805592-S100	17121	257	N90775001	22111	NI 2	SSP42	5748	239	W707606-S300	20517	515
N805612-S	17102	390	N90775801	22110	NI 2	TO01-50-M48B	19450	616	W707638-S900C	22067	NI 5
N805612-S100	17102	390	N90-796-501	21485	688	TD11-56-694	21661	367	W707889-S300	20192	370
N805759-S100	16834	255	N90-796-502	21485	688	TD12-51-SJ3A	21412	389	W708035-S300	20531	369
N805889-S100	19480	108	N908-131-01	21817	NI 35	TY98TL2-AA	20541	377	W708045-S300	20532	515
N805995-S100	18331	261	N908-131-01	21817	NI 35	UB39-45-919	20465	622	W708088-S300	18770	365
N806113-S	20189	372	N-908132-01	20746	225	UB39-50-795	19747	622	W708319-S300	21239	515
N806126-S100	17408	253	N90813202	20746	225	UB42-67-013	19754	625	W708325-S300	14998	486

O.E.M. INTERCHANGE BY NUMERICAL ORDER

O.E.M. No.	Auveco No.	Page No.	O.E.M. No.	Auveco No.	Page No.	O.E.M. No.	Auveco No.	Page No.	O.E.M. No.	Auveco No.	Page No.
W708384-S309	20401	531	YS4Z-6730-AA	20347	224	01553-00051	14356	386	09409-08320	19257	397
W708456-S309	16883	64	YS4Z-6734-AA	21180	222	01553-00172	14737	383	09409-08327	22083	NI 27
W708513-S309	20776	531	YU5Z-13466-AD	16901	201	01553-00202	14347	386	0G032-50037-A	21146	607
W708530-S300	20632	491	YU5Z-13466-AD	B3457A	206	01553-00291	14355	382	0K95A-68615	21372	607
W708580-S300	21362	514	000-987-10-81	13157	627	01553-0034U	17350	596	0WX68XDB-AA	21427	543
W708621-S300	20190	398	000-988-15-81	13141	627	01553-0038U	21311	646	10003294	12919	132
W708633-S300	21313	376	000-988-16-25	20647	627	01553-00401	14355	382	10003617	12927	133
W708761-SSB	18275	375	000-988-55-81	13144	627	01553-0052U	20671	384	10004121	12943	133
W708761-SSB	15480	373	000-988-76-81	13141	627	01553-00545	17452	383	10005510	14968	498
W708771S300	20530	516	000-988-86-25	20404	627	01553-0075U	18948	366	10008002	8814	107
W708777-S437	22023	NI 5	000-990-03-92	13230	628	01553-01121	17452	383	10008002	10052	107
W708777-S900C	21286	260	000-990-22-92	13230	628	01553-01182	20256	366	10009923	12259	66
W709002-SAA	20624	369	000-990-299-2	21859	NI 22	01553-01393	16843	623	10013764	11352	498
W709176-S300	19639	489	000-990-34-92	20187	628	01553-01733	20196	675	10014363	12997	97
W709629-S300	20532	515	000-990-37-92	20314	628	01553-01781	17634	366	10017487	12931	131
W709688-S300	21790	NI 11	000-990-40-92	20640	628	01553-01A50	21519	366	10017615	14677	224
W709767-S300	20663	520	000-990-44-92	20639	628	01553-02253	21821	NI 29	10018202	12695	85
W709984-S300	20631	490	000-990-46-92	20641	628	01553-02741	17378	647	10027015	17230	467
W709955-S300	21247	397	000-990-54-92	20234	576	01553-02821	20670	392	1003	16918	201
W710079-S300	21373	259	000-990-57-92	20642	387	01553-02903	22063	NI 25	10031004	18014	201
W710250-S300	21089	523	000-990-609-2	21859	NI 22	01553-02913	21621	640	10032838	12713	468
W710312-S300	20761	370	000-990-84-92	21037	628	01553-02923	21688	NI 23	10036503	14023	245
W710459-S300	20466	468	000-991-59-40	21711	NI 22	01553-03101	17378	647	1004	16920	201
W710528-S300	20817	518	000-994-04-45	13224	67	01553-03201	20753	647	10040001	9282	232
W710532-S300	20926	370	000-994-06-45	13218	68	01553-03831	21121	637	10041588	14527	104
W710754-S439	21187	498	000-994-09-45	13220	69	01553-05131	21637	648	10051034	15467	351
W710791-S437	21215	531	000-994-14-45	13215	68	01553-05323	21192	603	10053182	14997	485
W710793-S439	21185	512	000-994-14-45	13216	68	01553-06071	21620	645	10053388	15045	493
W710923-S300	18680	374	000-994-25-45	13223	67	01553-06451	22075	NI 25	10062	12253	66
W711031-S300	21826	NI 11	001-988-03-25	21105	386	01553-06721	17347	647	10063599	18683	365
W711037-S300	20949	398	001-988-12-25	20646	627	01553-07111	20669	396	10069112	15488	245
W711079-S300	21368	514	001-988-20-81	16124	67	01553-08231	21545	646	10073833	12992	402
W711521-S300	20616	399	001-988-20-81	20205	626	01553-08911	21618	637	10077283	15042	493
W711687-S300	21199	367	001-988-44-81	21464	625	01553-08961	21295	382	10078274	18897	366
W711858-S300	21334	380	001-988-46-81	21466	625	01553-09241	19246	646	1008068	21853	NI 32
W712160-S300	21165	515	001-988-49-81	21433	625	01553-09311	19684	381	10082288	18390	476
W712196-S300	20889	491	001-988-50-81	21441	626	01553-09321	19274	647	10084751	19644	109
W712665-S300	20993	492	001-988-60-81	21468	625	01553-09431	21134	646	10089262	14987	485
W713202-S300	21172	522	001-988-63-81	21469	626	01553-09611	20349	677	10098645	18682	366
W713297-S300	21169	399	001-988-76-81	20205	626	01553-09791	20668	395	10102434	17436	509
W713331-S300	20989	490	001-988-80-81	21465	626	01553-10051	19905	647	10108746	16625	491
W713445-S300	21172	522	001-990-00-91	20651	67	01553-2D9R9	22039	NI 25	10109689	15490	246
W713579-S300	21794	NI 12	001-990-169-2	21859	NI 22	01553-2U001	21824	NI 24	10119816	18859	370
W713590-S300	21174	519	001-994-98-45	21823	NI 22	01553-S3500	13945	400	10119853	17128	469
W713610-S300	20988	489	00234-00192	20286	202	01553-S3500A	13945	400	10121502	17664	371
W713819-S900	21864	NI 4	00234-00194	16902	201	01651-00481	14695	587	10125439	16864	256
W714040-S300	20880	490	00234-01156	16904	201	028-103-059-A	21041	226	10126901	15669	401
W714599-S900	17420	250	00234-01156	B1156	206	03-446-243	12642	650	10129981	15811	65
W714975-S300	20992	491	002-988-51-81	20897	625	06509673AA	21601	545	10131511	18461	255
W715201-S300	21668	519	002-997-33-86-67	18302	365	06L-103-801	22143	NI 4	10134407	18030	489
W715537-S300	20826	490	003-988-41-78	20188	400	07-11-9-901-294	13215	68	10135796	18118	471
W715926-S300	21673	368	003-990-02-51	21431	576	07-11-9-901-299	13215	68	10139822	14911	485
W715951-S300	22053	NI 12	003-990-24-97	21184	257	07-11-9-916-945	13215	68	10140480	16835	486
W716351-S300	22099	NI 11	003-990-35-97	22122	NI 5	07-12-9-901-645	13223	67	10143422	17102	390
W716352-S300	22124	NI 11	003-990-94-97	20971	255	07-12-9-901-651	13218	68	10153057	16695	392
W716460-S300	21187	498	003-994-30-45	13218	68	07-12-9-904-150	22114	NI 3	10157547	16939	260
W716460-S300	22038	NI 11	004-988-76-78	20657	625	07-12-9-925-708	13223	67	10157900	16622	490
W716497-S300	21669	518	004-988-77-78	20657	625	07-12-9-925-720	13162	68	10158124	18175	390
W716503-S300	22033	NI 11	004-990-16-97	21286	260	07-12-9-925-737	13218	68	10160960	18935	259
W716510-S300	21703	NI 12	006-988-30-78	20201	625	07-13-0-702-516	21137	392	10167445	19357	475
W717736-S300	22154	NI 20	006-988-35-78	20199	626	07-13-0-702-715	20570	65	10167448	18428	474
W790173-S900	21202	518	006-988-89-78	21434	626	07-130-702-966	17267	573	1016937	22669	108
W790225-S900	22021	NI 9	007-988-34-78	20879	394	07-13-0-702-966	17267	573	10169777	20344	365
W-8	15015	86	007-988-71-78	21467	626	07-13-1-480-419	21709	NI 23	10184895	13751	246
WPT-118	20851	194	007-988-99-78	20879	394	07-13-2-757-821	21659	631	10185925	18301	370
WPT-159	20842	191	01241-00551	17193	649	07-13-7-073-915	21527	631	10186453	18691	495
WPT-169	20843	190	01241-00881	21459	649	07-14-3-448-498	18156	35	10195515	14995	485
WPT-173	18671	192	01281-00022	14331	639	07-14-6-963-883	22110	NI 2	10201332	19514	256
WPT-335	20848	185	01281-00023	14275	665	07-14-7-122-912	22086	NI 16	10204266	18170	261
WPT-793	20847	186	01281-0005U	21318	641	07-14-7-122-913	21854	NI 15	10207146	17226	426
WX68DX9-AA	20739	542	01281-00151	14335	640	07-14-7-129-160	22030	NI 2	10220168	18688	374
XL3Z-17E971-AA	19607	524	01281-00231	14275	665	07-14-7-129-161	22030	NI 2	10229437	18680	374
XW1Z-5822008-AA	18891	532	01281-00331	21111	641	07-14-7-145-753	21139	393	10237960	19220	500
XW7Z-6302354-AAB	20625	375	01281-00441	17342	639	07-14-7-201-307	22084	NI 14	10241518	18688	374
YF4Z-8194-AA	20400	517	01281-00501	21367	640	07-14-7-293-278	22146	NI 6	10242285	20521	479
YL3Z-1521970-AA	20153	531	01281-00601	19293	640	07-14-7-391-323	22144	NI 6	10242316	18680	374
YL3Z-1521970-AB	20153	531	01281-00691	21324	640	07-14-7-391-324	22131	NI 6	10246149	19788	485
YL3Z-1521971-AA	20195	531	01281-00711	20604	640	07-14-9-158-194	21762	NI 14	10249241	19501	374
YL3Z-1521971-AB	20195	531	01281-00801	17342	639	09409-04304	14367	365	10261327	19410	470
YR3Z-13466-AD	B3157A	206	01281-00831	20764	639	09409-06309-5ES	21691	NI 27	10262036	18684	365
YR3Z-13466-AD	B4157	206	01281-01081	20736	641	09409-07303-5ES	19128	678	10262143	19247	467
YS4Z-13N021-AA	18661	203	01281-01121	19741	587	09409-07313	17383	486	10270517	20464	481
YS4Z-13N021-AA	20601	204	01281-01321	21425	602	09409073255PK	19243	484	10270672	19390	476
YS4Z-16K262-AA	20191	523	01515-0009U	21113	255	09409-07332	20908	678	10274778	19819	351

O.E.M. INTERCHANGE BY NUMERICAL ORDER

O.E.M. No.	Auveco No.	Page No.	O.E.M. No.	Auveco No.	Page No.	O.E.M. No.	Auveco No.	Page No.	O.E.M. No.	Auveco No.	Page No.
10277480.....	19676.....	467	11500421.....	2775.....	4	11503982.....	12066.....	52	11517706.....	13619.....	54
10278936.....	17654.....	247	11500434.....	15373.....	59	11504010.....	15721.....	59	11517803.....	16622.....	490
10281487.....	20395.....	501	11500654.....	18337.....	107	11504035.....	11627.....	109	11517824.....	19297.....	487
10283414.....	19368.....	381	11500655.....	11625.....	107	11504047.....	16842.....	108	11517873.....	20452.....	467
10285935.....	19270.....	392	11500656.....	18338.....	107	11504056.....	12738.....	59	11517992.....	20615.....	376
10287379.....	20261.....	52	11500657.....	11626.....	107	11504230.....	1943.....	3	11518017.....	17216.....	491
10287547.....	20408.....	476	11500658.....	11628.....	109	11504288.....	12667.....	109	11518017.....	20632.....	491
10287926.....	20232.....	472	11500660.....	11629.....	109	11504493.....	12323.....	52	11518091.....	20170.....	261
10287971.....	19275.....	391	11500661.....	11630.....	109	11504531.....	9879.....	104	11518201.....	20281.....	373
10293193.....	20893.....	366	11500662.....	11631.....	109	11504536.....	13002.....	99	11518357.....	20377.....	478
10297368.....	19381.....	479	11500663.....	18339.....	109	11504565.....	13619.....	54	11518531.....	21027.....	500
10297369.....	20521.....	479	1150086.....	12350.....	61	11504567.....	13614.....	53	11518684.....	20415.....	501
10297370.....	20825.....	480	11500971.....	12348.....	53	11504570.....	12067.....	51	11518937.....	22117.....	NI 8
10297371.....	19379.....	480	11500994.....	12057.....	61	11504614.....	15327.....	64	11518988.....	21036.....	480
10298115.....	19486.....	464	11500996.....	12339.....	61	11504659.....	2710.....	1	11519023.....	21115.....	260
10301966.....	20365.....	489	11500997.....	12354.....	61	11504662.....	14046.....	2	11519023.....	21142.....	260
10305191.....	20814.....	392	11501105.....	11633.....	52	11504693.....	11626.....	107	11519031.....	20616.....	399
10308019.....	20521.....	479	11501188.....	13614.....	53	11504978.....	12666.....	108	11519032.....	21189.....	399
10308063.....	20520.....	477	11501193.....	11641.....	54	11504981.....	12068.....	61	11519408.....	21047.....	224
10319395.....	20859.....	202	11501194.....	13620.....	54	11504982.....	12343.....	53	11519444.....	14010.....	487
10323057.....	20607.....	478	11501794.....	12739.....	58	11505005.....	12596.....	64	11519444.....	20359.....	490
1034.....	16925.....	201	11501800.....	15334.....	64	11505022.....	12351.....	61	11519444.....	20631.....	490
10341794.....	20464.....	481	11501814.....	12254.....	66	11505023.....	12339.....	61	11519444.....	20888.....	490
10350983.....	21346.....	390	11501835.....	12253.....	66	11505044.....	18416.....	52	11519949.....	19239.....	594
10351052.....	21347.....	466	11501836.....	12255.....	66	11505104.....	13712.....	58	11519952.....	20422.....	501
10351666.....	21222.....	211	11501849.....	12260.....	66	11505182.....	14053.....	57	11519960.....	20423.....	501
10352797.....	20809.....	477	11501850.....	11645.....	65	11505209.....	13618.....	52	11546635.....	22036.....	NI 10
10352798.....	20973.....	477	11501883.....	12059.....	58	11505326.....	15790.....	53	11546805.....	22071.....	NI 9
10352799.....	20808.....	477	11501884.....	12060.....	29	11505329.....	12595.....	64	11547210.....	22029.....	NI 10
10352803.....	19800.....	477	11501889.....	11644.....	65	11505329.....	16268.....	64	11547341.....	21835.....	NI 12
10352804.....	20974.....	477	11501896.....	12061.....	27	11505596.....	18338.....	107	1155.....	18470.....	201
10352809.....	20775.....	477	11501903.....	12062.....	58	11506101.....	11645.....	65	1156.....	B1156.....	206
10353835.....	20811.....	477	11502483.....	12097.....	59	11506117.....	15335.....	64	1156.....	16904.....	201
10363352.....	21177.....	481	11502507.....	15711.....	66	11506174.....	12693.....	51	11561143.....	12127.....	66
10363811.....	20634.....	390	11502605.....	11639.....	53	11507036.....	11644.....	65	11561329.....	21200.....	480
10369649.....	21240.....	393	11502609.....	11644.....	65	11507036.....	16269.....	65	11561353.....	14998.....	486
10382313.....	21176.....	494	11502617.....	11629.....	109	11508023.....	12322.....	51	11561368.....	20888.....	490
10383817.....	21157.....	482	11502624.....	11639.....	53	11508241.....	12575.....	108	11561448.....	18153.....	500
10384814.....	20950.....	481	11502722.....	19309.....	65	11508269.....	13614.....	53	11561491.....	20884.....	481
10403591.....	19449.....	380	11502737.....	12127.....	66	11508275.....	15330.....	64	11561499.....	21383.....	390
10405030.....	19368.....	381	11502759.....	12126.....	66	11508430.....	12339.....	61	11561500.....	21384.....	469
10408480.....	19527.....	391	11502770.....	10171.....	1	11508900.....	12253.....	66	11561509.....	20261.....	52
10410398.....	19220.....	500	11502785.....	11627.....	109	11508927.....	13002.....	99	11561654.....	21333.....	398
10421018.....	20338.....	392	11502790.....	11935.....	53	11508930.....	15791.....	51	11561655.....	20938.....	467
10423553.....	20481.....	479	11502811.....	11709.....	64	11508987.....	14185.....	65	11561740.....	19644.....	109
10425306.....	20365.....	489	11502812.....	11708.....	64	11509189.....	12350.....	61	11561874.....	21361.....	493
10426555.....	21400.....	494	11502941.....	12693.....	51	11509371.....	12057.....	61	11561878.....	17222.....	488
10426887.....	20775.....	477	11503317.....	11630.....	109	11509374.....	12741.....	59	11561987.....	21518.....	469
10431503.....	20775.....	477	11503394.....	12740.....	58	11509511.....	11639.....	53	11562043.....	20995.....	390
10431523.....	20810.....	477	11503395.....	12741.....	59	11509535.....	15711.....	66	11562044.....	20996.....	390
10431524.....	19757.....	476	11503396.....	12742.....	59	11509589.....	11638.....	53	11562147.....	20868.....	481
10431526.....	20811.....	477	11503421.....	12213.....	4	11509816.....	12067.....	51	11562250.....	21242.....	479
10431761.....	19821.....	481	11503432.....	12117.....	66	11510062.....	12253.....	66	11562256.....	20998.....	391
10437565.....	19800.....	477	11503455.....	12667.....	109	11513599.....	21040.....	107	11562257.....	20999.....	391
10442914.....	20353.....	479	11503483.....	12742.....	59	11513798.....	20600.....	204	11562364.....	21187.....	498
10443956.....	20328.....	478	11503503.....	12097.....	59	11513798.....	BH3.....	209	11562503.....	21753.....	NI 8
10444839.....	21228.....	375	11503578.....	18261.....	59	11513801.....	12738.....	59	11562563.....	21128.....	478
10445899.....	21504.....	479	11503619.....	13613.....	53	11513864.....	12064.....	51	11562568.....	22034.....	NI 9
10476561.....	9282.....	232	11503632.....	12336.....	53	11514282.....	15711.....	66	11562588.....	21047.....	224
106212.....	14335.....	640	11503636.....	12213.....	4	11514343.....	11639.....	53	11569618.....	20423.....	501
106653.....	12543.....	172	11503668.....	13705.....	53	11514518.....	11644.....	65	11569697.....	21161.....	482
10708.....	12522.....	86	11503687.....	15310.....	62	11514596.....	11644.....	65	11569700.....	22031.....	NI 9
10709.....	12520.....	86	11503695.....	15335.....	64	11514623.....	12067.....	51	11569768.....	11146.....	371
1073.....	18004.....	201	11503714.....	11864.....	108	11515478.....	12575.....	108	11569918.....	21129.....	479
1076.....	18469.....	201	11503715.....	12575.....	108	11515566.....	18781.....	59	11569920.....	21158.....	476
10998-30880.....	14696.....	595	11503716.....	11864.....	108	11515638.....	22074.....	NI 3	11569921.....	22037.....	NI 10
11005.....	20299.....	202	11503736.....	14980.....	66	11515756.....	11639.....	53	11569973.....	20891.....	482
11006.....	20300.....	202	11503745.....	19205.....	65	11515757.....	13614.....	53	1156A.....	B1156A.....	206
11026-01M02.....	21258.....	222	11503752.....	12595.....	64	11516148.....	18477.....	201	1156NA.....	17597.....	201
11026-JA00A.....	21258.....	222	11503754.....	12596.....	64	11516150.....	11630.....	109	1157.....	B1157.....	206
1104882.....	21859.....	NI 22	11503756.....	12596.....	64	11516150.....	12667.....	109	1157.....	16899.....	201
11126AA000.....	19139.....	222	11503785.....	18261.....	59	11516372.....	20416.....	108	11570082.....	13614.....	53
11128-01M0B.....	21293.....	223	11503791.....	13715.....	51	11516397.....	20339.....	107	11570512.....	21156.....	479
111-837-5815.....	13031.....	689	11503800.....	12324.....	51	11516440.....	3079.....	3	11570637.....	22070.....	NI 1
111-837-581J.....	13031.....	689	11503812.....	12064.....	51	11516596.....	13705.....	53	11570830.....	21674.....	467
11296-AG000.....	20953.....	647	11503815.....	12322.....	51	11516780.....	15335.....	64	11570846.....	21370.....	480
113-853-585C.....	13229.....	682	11503825.....	13618.....	52	11516807.....	20741.....	258	11570847.....	22027.....	NI 10
113-853-615A.....	13227.....	67	11503833.....	15788.....	52	11516936.....	18927.....	257	11571118.....	21535.....	391
113-857-219A.....	13206.....	685	11503834.....	12065.....	52	11516942.....	13619.....	54	11571119.....	19759.....	400
1141.....	B1141.....	206	11503892.....	15373.....	59	11517071.....	11708.....	64	11571119.....	21536.....	391
1141.....	16923.....	201	11503941.....	13617.....	51	11517293.....	12596.....	64	11571159.....	21443.....	376
1142.....	20681.....	202	11503957.....	11864.....	108	11517343.....	12065.....	52	11571175.....	20934.....	479
1149900192.....	21859.....	NI 22	11503957.....	12669.....	108	11517517.....	12324.....	51	11571175.....	21242.....	479
11500086.....	12350.....	61	11503958.....	13715.....	51	11517700.....	19449.....	380	11571175.....	21374.....	479

O.E.M. INTERCHANGE BY NUMERICAL ORDER

O.E.M. No.	Auveco No.	Page No.	O.E.M. No.	Auveco No.	Page No.	O.E.M. No.	Auveco No.	Page No.	O.E.M. No.	Auveco No.	Page No.
1157A	B1157A	206	12010973	15951	152	12085498	16694	178	12129484	20212	154
1157NA	16901	201	12010974	18146	152	12085502	16964	180	12129493	18658	154
11588308	18461	255	12010975	18152	152	12085503	16514	179	12129497	18659	154
11588308	21327	245	12010996	15949	152	12085506	18918	180	12157-10010	21116	222
11588441	21351	501	12012000	14884	157	12085507	16965	180	12160374	20665	496
11588650	20883	499	12013813	13543	176	12085525	17109	179	12160551	20211	156
11588818	21200	480	12014012	14462	152	12085527	17109	179	12160857	20514	497
11588863	20944	390	12014254	20751	159	12085528	17109	179	12160858	20397	496
11588988	20631	490	12014836	14153	151	12085533	17199	180	12167116	18916	177
11589015	12738	59	12014837	14154	151	12085538	18917	178	12176844	19853	497
11589176	20972	477	12015024	18148	152	12089040	14150	151	12186456	20220	154
11589181	21199	367	120151	12546	172	12089188	14151	151	12186457	20221	155
11589182	20868	481	12015193	20618	151	12089189	13659	145	12191645	16351	172
11589244	20891	482	12015323	14152	151	12089189	19258	145	12337831	20892	483
11589289	19801	489	12015387	15923	152	12089190	13669	145	12337852	14031	466
11589289	20988	489	12015631	19795	496	12089190	19259	145	12337868	15518	503
11589290	13996	489	12015791	15950	152	12089191	13678	145	12337873	10054	107
11589290	14007	487	12015792	15952	152	12089191	19262	145	12337898	17341	351
11589290	14753	485	12015793	15954	152	12089305	15948	151	12337900	16953	495
11589290	20880	490	12015797	18145	152	12089306	18325	151	12337915	15490	246
11589291	20989	490	12015798	18147	152	12089307	20747	151	12337916	15783	22
11589292	20991	491	12015799	18151	152	12089340	16806	154	12337917	12669	108
11589293	20889	491	12015857	14881	154	12089649	14883	153	12337920	12737	401
11589294	20992	491	12015858	20216	154	12092075	16360	172	12337920	14524	401
11589295	20993	492	12015861	15938	155	12092080	16355	172	12337966	11630	109
11589296	20994	492	12015862	15948	151	12092081	16354	172	12338011	15467	351
11609292	22035	NI 11	12015870	15945	155	12092344	20226	155	12338015	17437	509
11609317	20422	501	12015878	17002	153	12092345	20227	155	12338025	13009	99
11609411	12596	64	12015899	20749	151	12094429	20583	157	12338034	15453	340
11609417	20826	490	12015917	18324	151	12100	17995	201	12338074	16936	510
11609483	21377	495	12015972	15952	152	12101855	18870	177	12338089	12594	472
11609535	20527	469	12015983	16941	496	12101856	18320	178	12338096	12824	472
11609651	21745	NI 8	1201-930	13195	689	12101857	18318	178	12338114	9112	125
11609731	21115	260	12020116	14880	154	12101859	18318	178	12338123	2775	4
11609738	14980	66	12020120	15939	155	12101869	18151	152	12338146	8814	107
11609762	22081	NI 1	12020126	15944	155	12101880	18867	177	12338146	10052	107
11609836	22121	NI 11	12020320	11948	153	12101895	17109	179	12338153	11621	252
11609923	21667	480	12020321	18650	153	12101897	16174	177	12353912	15463	350
11609952	21027	500	12020347	15935	153	12101898	16175	177	12354969	15948	151
11609952	21754	NI 8	12020757	14883	153	12101903	17690	181	12354970	15937	151
11610049	21164	495	12020801	20748	151	12101906	16967	177	12355104	9481	150
11610086	15543	372	12027133	18923	176	12101909	13548	182	12355107	14150	151
11610157	21524	500	12033674	14150	151	12101909	17691	182	12355107	14153	151
11610210	21114	254	12033817	15960	153	12101917	13686	170	123-990-00-92	20636	629
11610271	14046	2	12034046	15947	154	12101927	19554	182	123-990-02-92	20637	629
11610383	21124	259	12034047	15946	154	12101933	18316	181	123-990-05-92	21044	628
11610495	21793	NI 9	12034051	14151	151	12101937	17113	179	123-994-08-45	20650	68
11610522	21157	482	12034342	18149	152	12101939	18871	183	1243-50-609	12591	617
11610544	22040	NI 8	12040902	15924	153	12102568	17463	180	1244839	9965	691
11610605	21488	387	12040983	19851	496	12102620	16693	178	12450053	18001	201
11610606	21489	388	12040984	19440	496	12102621	14580	179	12450143	8884	207
11610705	20938	467	12041351	20618	151	12102664	21490	178	12450143	8893	207
11610747	21301	372	12043215	16694	178	12102747	17110	178	12450176	20595	203
11610748	21302	495	12045234	15927	171	12102748	18527	179	12450313	8921	206
11611079	21671	476	12045236	15926	171	12102757	19555	182	1-246-926	14212	690
11611110	21672	490	12045773	18653	154	12103360	20230	155	1-246-993	14209	690
11611375	21825	NI 9	12046624	16693	178	12103881	15497	154	1247872	15459	501
11611435	21827	NI 10	12047581	15498	154	12110842	20217	155	124-988-04-78	21435	626
11611623	22080	NI 10	12047680	15497	154	12110843	20219	155	124-988-90-78-M89	22115	NI 22
11611626	21739	NI 10	12047767	15499	154	12110844	20218	155	124-988-94-78	21759	NI 22
11612035	22100	NI 9	12048074	18654	154	12110845	20222	155	124-990-04-92	20909	629
11612122	22036	NI 10	12048369	14918	177	12110846	20225	155	124-990-05-92-9051	20640	628
1165051	19626	691	12052922	16806	154	12110847	20224	155	124-990-07-92	20203	629
1165051	19627	691	12065158	18150	152	12116958	17111	178	12499007929C75	20203	629
1176	20585	202	12066214	14881	154	12117353	18526	181	12519972	18429	473
117971	4417	332	12066614	20231	155	12117354	19556	181	12519975	18417	473
119005	16897	203	12076946	17175	176	12117361	17109	179	12530252	17654	247
1196781	3682	38	12083005	16585	176	12117375	18526	181	12533567	17103	488
12001470	13549	174	12083006	16586	176	12117384	13547	182	12535713	19398	402
12003757	13546	176	12083007	17108	174	12117385	17107	179	12540326	19725	507
12003758	13545	176	12083460	18924	174	12117387	18145	152	1254815	11838	465
12003759	12600	176	12083680	17172	177	12124075	20214	154	1255	BH3	209
12003878	13544	175	12083689	17173	177	12124076	20215	154	1255/H3	20600	204
12004005	12536	172	12084595	15948	151	12124304	15938	155	1-255-551	14211	689
12004009	12540	172	12084912	20209	156	12124515	8774	153	1-255-553	14210	690
12004010	16359	172	12084913	20210	156	12124580	15937	151	1255823	11865	467
12004188	19199	166	12085270	20752	159	12124581	18324	151	1257702	14217	497
12004201	8775	153	12085330	17174	177	12124582	15948	151	1260/H4	20601	204
12004311	12237	174	12085483	18916	177	12124587	18325	151	1260888	19166	105
12010085	15948	151	12085485	19882	180	12125637	11440	182	1264963	12713	468
12010182	15937	151	12085491	16968	180	12126451	18674	179	1268176	19248	690
12010293	18326	151	12085495	18868	178	12126452	15952	152	1268642	21859	NI 22
12010300	15955	151	12085496	17114	177	12129373	20213	154	126-990-03-92	21044	628
12010717	15953	152	12085497	18524	178	12129409	20223	155	127934	16910	201

O.E.M. INTERCHANGE BY NUMERICAL ORDER

O.E.M. No.	Auveco No.	Page No.	O.E.M. No.	Auveco No.	Page No.	O.E.M. No.	Auveco No.	Page No.	O.E.M. No.	Auveco No.	Page No.
127934	20703	210	14097279	16739	22	15569071	20797	342	15944588	21248	372
127934	B57	206	14100784	17382	500	15569072	20798	342	15953247	17649	402
1295NA	19208	201	14101262	15702	493	155-809-966	12735	466	15954398	19429	467
1304225	4249	339	14103026	12084	249	15588024	13946	402	15955172	13752	246
13050	17994	201	14103026	17424	250	15588078	14032	370	15955523	17654	247
131282	16914	201	14103435	16953	495	15591860	19424	508	15956062	18169	256
13144822	21541	60	14103438	15042	493	15596279	14031	466	15956470	14998	486
131-853-585C	10322	682	14103461	15043	492	15596280	14037	468	15958694	11146	371
13235-A	8763	197	14103461	15045	493	15596301	13946	402	15958694	15414	371
13252118	21365	387	142451	20292	202	15597271	14215	471	15959832	18268	493
13252119	21364	388	142451	B68	206	15598757	15792	21	15959833	18334	493
13-3008-L	15004	86	142452	16911	201	15600382	12992	402	15960325	18353	494
13-3026-L	15010	86	142452	20705	210	1560058	19626	691	15960621	19355	488
13365058	22025	NI 9	142453	18015	201	1560058	19627	691	15963179	16938	391
13503401	16902	201	142454	16926	201	15606344	20792	342	15964971	16936	510
13503417	B885	207	142456	16923	201	15606409	20792	342	15964972	16937	510
1351769	9112	125	142456	B1141	206	15607139	18105	499	15967691	19424	508
1355003	9069	466	1445	18472	201	15607165	15970	402	15969147	17216	491
13584255	21220	179	1449	18473	201	15612948	15970	402	15975244	19834	372
13585316	18868	178	145525	14388	215	15614746	21028	245	15986343	18371	370
13586114	17110	178	14591787	21802	NI 34	15614774	18244	257	15986673	19356	391
13-6003	15017	87	14592086	21804	NI 34	15622490	17615	254	15989431	21380	376
13-6005	15018	87	14592087	21803	NI 34	15632790	17508	500	15989487	19387	495
1366042	16739	22	1480627	8359	106	15638413	16938	391	15993201	16622	490
1370853	12735	466	1480909	8377	106	15641800	11110	22	15994165	20542	489
1377030	10365	468	14913-05010	21150	599	15646148	17343	508	1600375	10759	463
13-8004	15015	86	14913-05010	21150	599	15648833	14988	522	1605396	11146	371
1395-68-676	14369	434	1494252	8359	106	15650655	9880	104	1605396	15414	371
14002811	13002	99	1494253	10830	106	15653790	19781	507	1606642	11657	463
14003784	16986	62	1494254	10054	107	15659161	17072	379	16-092-672-80	21812	NI 34
14004876	12931	131	1494257	10051	106	15672149	19242	484	161	20285	202
14005089	11854	486	1494258	8814	107	15672183	19782	507	1610403	12917	132
14005097	16248	99	1494258	10052	107	15672328	17599	403	16-13-1-176-747	21431	576
14007510	13231	21	15002520	18262	499	15672330	14998	486	1614858	12931	131
14007510	13232	21	15014352	20943	485	15672713	18167	252	1617333	12919	132
14007511	14976	21	15015804	18889	259	15678493	17215	377	161-867-299-01C	19195	687
14007940	12999	97	15025531	19616	499	15679091	14953	522	1618890	11470	463
14008227	12210	341	15026222	20158	559	15681408	17103	488	1618890	11657	463
14011722	11109	22	15026223	20157	559	15682898	18262	499	1619321	12137	374
14013246	13960	466	15029828	4369	339	15683327	21387	498	1619321	16263	374
14017701	12930	131	15031239	17654	247	15685040	19424	508	1621253	12935	131
14017705	12923	132	15037290	10080	548	15685099	20415	501	1623436	12998	97
14017779	12947	133	15040331	21290	501	15686047	15792	21	1624705	2744	691
14017780	12924	132	15056810	20362	374	15686142	18153	500	1624705	12959	691
14019205	12567	487	15061964	21195	345	15690531	18744	244	1631564	15478	374
14019205	14007	487	15076791	20444	398	15691493	16936	510	1635218	12999	97
14019226	14011	487	15078238	20860	499	15691595	19424	508	1636632	16624	489
14022878	12621	472	15116576	20935	480	15694099	18391	390	1638	20295	202
14023108	12925	132	15127746	20934	479	15704030	19515	257	1638575	19162	105
14025274	12916	132	15149708	19639	489	15705372	11246	462	1640810	15373	59
14027471	12759	375	15153415	19615	491	15707256	19317	39	1641-B	9257	228
14027775	20799	342	15175428	12930	131	15709521	18262	499	1644290	18948	366
14027776	20800	342	15199562	B4114K	206	15714775	11655	463	16500308	14016	488
14027777	20793	342	15209748	21106	171	15714775	11871	464	16502342	20301	36
14027778	20794	342	15221959	20865	477	15715058	17654	247	16503329	14002	465
14029095	12940	133	152266	8375	106	15718794	13755	245	16503548	14145	466
14031114	12926	132	152267	8372	106	15732202	18028	245	16506582	17000	462
14031144	12916	132	152273	15677	106	15733970	19614	469	16510893	15676	465
14031145	12932	133	15227654	20792	342	15733971	19613	469	16524431	18662	203
14031900	16880	65	15227655	20792	342	15737532	12520	86	1654047	11345	348
14032200	14008	483	15236893	20951	481	15737533	12522	86	165-827-592	21480	684
14032291	14009	468	15236894	20952	478	15745990	20527	469	1660123	11717	471
14037239	18926	503	15281294	20864	464	15745991	20529	469	16606936	17069	502
14039420	14001	484	15282120	20935	480	15748479	20268	499	16607593	14967	548
14040999	16322	108	15288146	20885	478	15748479	20268	499	16609280	19399	502
14045480	14010	487	15289020	20527	469	15762170	14921	365	16611888	18420	476
14046480	12728	497	15296830	20990	490	15763285	14921	365	16611889	18418	473
14047034	12929	131	15300530	19882	180	15764320	19616	499	16615006	19370	475
14048060	13005	99	15305932	18524	178	15769308	21290	501	16627328	20675	548
14063981	13750	246	15306157	21006	176	15772605	16908	201	16629990	19658	503
14066728	17437	509	15326410	19836	366	15772605	B2057A	206	16630688	21196	502
140-698-00-82	20656	626	15328724	16352	172	15773445	14753	485	16630689	21197	502
14070914	13749	245	153297	16478	27	15786626	19819	351	16632192	16937	510
14071289	14011	487	154508	16531	29	158	18014	201	16632193	16936	510
14074081	14036	370	154534	16534	29	15802005	21338	373	16633853	17069	502
14078435	11852	251	15502538	8931	240	15822417	21474	171	16662182	19519	499
14082956	18817	59	15505451	16251	99	15824471	20945	558	16674629	20189	372
14083173	14820	500	15506827	14012	246	15828918	B3157A	206	16675980	19658	503
14083901	14952	57	1550971	18474	201	15862656	21033	181	16715497	17468	256
14090382	19278	59	15545178	18926	503	15862656	21542	181	16723225	12084	249
14090908	16026	222	15545202	15670	402	15864780	22037	NI 10	16723225	17427	250
14093088	14020	526	15562609	16937	510	15872008	20884	481	16-7552	9481	150
14093311	10831	371	15562610	17976	508	15893516	20885	478	16758	4248	338
14093869	14980	66	15567924	15459	501	15931605	21379	399	16758A	4155	339

O.E.M. INTERCHANGE BY NUMERICAL ORDER

O.E.M. No.	Auveco No.	Page No.	O.E.M. No.	Auveco No.	Page No.	O.E.M. No.	Auveco No.	Page No.	O.E.M. No.	Auveco No.	Page No.
168	B168	206	19260058	21404	505	20331307	12568	497	2096467	15504	157
168	16921	201	19260060	21403	505	20338568	13925	469	20985619	21045	558
1688094	11425	471	19260061	21406	506	20345137	14549	509	21006725	18023	224
1689827	12095	27	19260063	21444	506	20346654	14217	497	21011332	12254	66
1706200	13828	472	19260663	21072	504	20348200	12315	510	21021319	18749	258
171-201-969	21456	689	19260663	21582	506	20351035	12065	52	21030249	17216	491
17131	20589	202	19299324	20485	504	20363491	13999	488	21030249	17216	491
17171	20590	202	193	18013	201	20374473	12737	401	21035018	14031	466
17177	20591	202	19300089	13659	145	20374473	14524	401	21035345	19297	487
171-807-249-A	21494	400	193065	18474	201	20376243	4441	339	21039129	17975	378
1719245	21859	NI 22	194	B194	206	20393536	14033	472	21039141	17215	377
1729250	11485	470	194	16902	201	2040	19209	204	21042045	17218	389
1732326	12315	510	194A	B194A	206	20413107	11612	366	21042053	17218	389
1746408	18817	59	194NA	18012	201	20421672	13752	246	21042058	17218	389
1-74-713	12642	650	19630330	19389	474	20421800	12992	402	21042098	17214	485
1-74-820	19153	650	198	16924	201	20423550	15774	27	21042104	17218	389
17562	4260	338	199	18466	201	20423647	13747	245	21047094	16816	488
1758099	2752	692	1999366	16898	203	20426301	14260	676	21075387	19101	51
1758099	12960	692	1999367	20859	202	20429451	13992	401	21075686	17222	488
175-820-435	16252	99	1999482	20620	202	20429500	14553	509	21077123	19801	489
175-853-577-01C	13748	245	1BA41AX1-AA	20763	540	20430956	13858	497	21077131	17616	493
175-853-577A	13753	246	1BA41XWG-AA	21175	540	20432975	13748	245	21077323	17226	426
175-853-673	14013	483	1F1Z-19E889-AA	19235	331	20433026	13753	246	21077405	17227	486
175-853-674	14014	466	1H0-819-055-B01C	21392	372	20444103	13458	472	21077575	18033	381
175-867-299	13475	400	1H0-819-055-C01C	21452	688	20451119	13457	484	21093588	17219	472
17635	20592	202	1H0-823-397	21483	688	20451401	13461	401	21094146	16818	369
1-76-651	13207	650	1H0-837-719	21497	385	20452072	14753	485	21094240	18515	51
176653	16134	66	1H0-853-585	21394	683	20453400	12064	51	21094747	17220	245
176-941-117A	15666	682	1H0-853-585-A	21396	684	20455900	14006	365	21095797	18896	492
17916	20593	202	1H0-853-585-B	21395	683	20461373	13856	495	21097229	19854	488
179-813-881	14030	466	1H0-853-586	21397	685	20462090	16865	483	21098967	19397	350
179-813-883	12735	466	1H0-853-733B	19136	682	20465395	14005	245	21110145	16816	488
17988488	14820	500	1H0-867-199-01C	21789	NI 32	20475949	14013	483	21110201	16818	369
17997722	14820	500	1H0-867-199-A	21482	688	20475950	14014	466	211-2	16913	201
1815	18474	201	1H0-868-243	21393	403	20477732	16687	255	211-988-00-81	20773	626
1816	16919	201	1H0-868-243-B	21415	403	20477850	15464	351	212-2	18011	201
1839906	18953	148	1H5-863-849-A-01C	21145	687	20478294	13860	495	21512-23001	21135	224
18647-55009-E	BH9	209	1J6-867-276	22116	NI 31	20478295	13456	495	21512-23001	21135	224
18649-55009-H	BH11	209	1L5Z-17K826-AA	19638	546	20478733	15462	350	21513-21000	19007	222
18649-60556	18661	203	1R3Z-18D434-BA	21445	529	20480475	13453	401	21513-23000	19007	222
18649-60556-L	18661	203	1U2Z-14S411-AEA	20843	190	2048248	11673	373	21513-23001	19621	222
1889	18003	201	1U2Z-14S411-AJA	18671	192	20493450	17455	351	217-770	15932	171
1891	18002	201	1U2Z-14S411-BPA	20842	191	20510029	13993	489	217-771	15933	171
1893	B1893	206	1U2Z-14S411-TA	20851	194	20511451	13454	368	2201406	12522	86
1893	16909	201	1U2Z-14S411-YA	21490	178	20514862	15367	367	2201407	12520	86
1895	B1895	206	1U5Z-13466-BB	16901	201	20538173	18302	365	2207713	16132	372
1895	16906	201	1W1Z-19E889-HB	17604	331	20547865	14147	492	22189414	20360	372
1900654	9361	357	1W6Z-238A90-AA	20363	527	2057	B2057	206	222	20287	202
19115561	11083	166	20030401	15457	377	2057	16907	201	22-44567-000	19844	561
19115586	19199	166	20032850	11679	367	20570245	13994	492	22505958	12934	132
19115640	21476	171	20037597	12314	510	2057A	B2057A	206	22508049	12932	133
19116359	21475	171	20043351	19183	508	2057NA	16908	201	22508050	12918	132
19119304	21752	NI 3	20043361	19183	508	20582532	18392	502	22508051	12937	131
19130464	10649	219	20046147	14559	508	20582533	18393	502	22508052	12927	133
19130464	14547	496	20046150	11816	471	20590899	13996	489	22508803	11419	133
19130464	20471	496	20058837	18398	482	20603072	11152	348	22512276	12766	374
19149964	20450	65	20064875	15456	377	20606417	14946	471	22512276	16262	374
19152583	14524	401	20085729	17073	352	20612732	13746	245	22512857	12605	463
19168447	13669	145	20097200	12569	514	20624923	14014	466	22513813	12605	463
191-853-577	21508	682	2011554	12084	249	20626174	19394	352	22514924	14821	465
191-853-577-A	21390	682	2011554	17427	250	20632190	17666	482	22516030	20450	65
191-853-733-A	21416	682	20123070	15467	351	20635065	13994	492	22527147	18748	499
191-941-142	21498	684	20130258	13002	99	2064891	10621	401	22527720	14035	370
192	20286	202	20130258	13003	99	2064891	16260	401	22529733	2293	103
19206781	15499	154	20160591	15466	351	20652520	18679	374	22531616	11631	109
19207416	21193	558	20162174	17176	351	20664092	14753	485	22535007	15044	493
19209790	21828	NI 3	20169887	12135	348	20687704	16624	489	22536642	18298	366
19209791	21829	NI 3	20171942	12594	472	20699808	14921	365	22537749	14220	468
19209792	21830	NI 3	20175051	12563	471	20712176	15463	350	22538004	14993	486
19209793	21831	NI 3	201-988-04-78	20202	625	20713843	15684	251	22538102	14990	485
19209793	21831	NI 3	201-990-00-50	20645	629	20-72-175	13220	69	22539533	15462	350
19209794	21832	NI 3	201-990-02-92	20638	629	2072728	8746	85	22543363	17176	351
19209795	21833	NI 3	201-990-05-36	21774	NI 2	20732399	10831	371	22550254	17545	470
19209796	21834	NI 3	20199675	14642	472	20734005	17092	402	22566142	15684	251
19209797	21749	NI 3	201-997-22-81	20659	627	2074089	8971	722	22566221	17106	488
19209798	21750	NI 3	20200750	18510	379	20747508	17341	351	22569178	18927	257
19209799	21751	NI 3	20237057	12602	472	20747509	17159	351	22578985	18911	470
19209800	21752	NI 3	2024778	18938	260	2075380	19055	240	22579423	18927	257
19257054	16898	203	2024781	8300	240	2084421	8774	153	22585836	18912	256
19257054	B9006	208	20274997	12824	472	2085119	16940	259	22587036	18310	493
19257055	B9004	208	20298365	11677	402	2085119	19057	240	22587341	12081	249
19257057	20599	204	20319841	12731	373	2085823	19060	240	22595587	14988	522
19258649	21006	176	20325696	12656	254	2096454	17115	157	22599312	20263	472
19260056	21487	507	20328600	15467	351	2096466	14892	157	22600612	18930	399

O.E.M. INTERCHANGE BY NUMERICAL ORDER

O.E.M. No.	Auveco No.	Page No.	O.E.M. No.	Auveco No.	Page No.	O.E.M. No.	Auveco No.	Page No.	O.E.M. No.	Auveco No.	Page No.
22603384	19820	478	25630331	19411	474	2977607	11444	181	3467-531	19153	650
22615352	19732	468	25631448	19417	61	2978302	8755	174	347065	16237	99
22638717	13750	246	25633289	18422	474	2978302X	8755	174	347347	13450	465
22638717	20740	258	25640501	3138	101	2998430	10332	373	347893	11292	102
22641917	18912	256	25642453	17103	488	2C52-13N021-AA	BH11	209	34906-S30-003	19207	201
22642756	20262	374	25648693	20280	475	2D1867741	21843	NI 22	34906-SLO-A01	20296	202
22643056	18889	259	25649667	20466	468	2F12-9A317-AA	20482	528	34906-SLO-A01	20730	210
22644361	19522	488	25663903	20265	486	2F12-9A317-BA	20483	528	34906-ST5-003	19207	201
22646099	19428	399	25672428	20279	402	30006620	19257	397	3496	20296	202
22649878	11691	466	25680782	14991	485	30008324	19243	484	3497	20297	202
22649879	11691	466	25691949	20522	475	30012018	14696	595	3509575	9905	174
22651066	18930	399	25693852	19822	478	3057	B3057	206	35113-SEC-A01	21079	561
22657634	19787	485	25695687	19892	487	3057	16915	201	3513686	13542	195
22657634	19788	485	25696693	19759	400	3057A	B3057A	206	3526573	19358	473
22659122	19335	484	25704001	20522	475	3057NA	16916	201	352839	4258	338
22677979	20666	486	25704141	19758	400	30624192	21785	NI 33	353123	1256	357
22677980	20666	486	25704358	21428	468	30653441	21786	NI 33	3533539	16940	259
22690838	21246	486	25705182	21517	61	3065575	11796	401	3533539	19057	240
22691056	21091	389	25707329	20244	494	3065575	16261	401	35337	15004	86
22718305	15480	373	25718851	20326	476	30753487	22138	NI 33	35366964	21047	224
22718369	21238	487	25722671	20318	475	30753556	22137	NI 33	3536966	18665	222
22722859	20634	390	25724529	20774	478	30784514	21784	NI 33	353745-S	2598	125
22722860	20635	469	25732397	21081	36	3078511	11130	377	3538469	21047	224
230-990-01-92	21086	629	25742293	20976	477	3104-426	13173	684	3540146	17640	261
23223178	20945	558	25744385	21503	481	3155	17997	201	3540161	16940	259
2357	B2357	206	25749564	21227	377	3156	B3156	206	3540161	19057	240
2357	17999	201	25762391	19758	400	3156	17996	201	354076	11246	462
2357A	B2357A	206	25774893	21375	482	3156A	B3156A	206	3540858	18308	491
2357NA	18000	201	25775903	21335	482	3156NA	18475	201	354341-S	5196	100
2396	17998	201	25796285	21681	NI 10	3157	B3157	206	354400	12939	133
24	B24	206	25803643	22026	NI 8	3157	16917	201	3548011	17640	261
24	18017	201	25822063	21287	375	3157A	B3157A	206	354860-S	4248	338
2409826	8742	85	25847343	21045	558	3157NA	18001	201	3548690	17640	261
24100042	21047	224	25922739	21370	480	3157NA-SA	18476	201	3548693	19363	469
2419255	8905	240	26019392	20094	560	3157SA	18479	201	3548804	18685	372
24205245	20528	365	26019395	20097	560	321-837-581-01C	14194	689	357020	12918	132
24220-89986	14345	648	26019399	20101	560	3236813	12927	133	3574085	11653	535
24225-89960	21259	649	26023-H1000	13931	639	3237451	12949	133	357811	4246	338
24233099	21093	224	26296-9B91D	BH9	209	3239826	12935	131	357-827-998	20933	685
24274-M3000	14346	648	26297-9B91A	BD52	209	33111-SR3-A01	18661	203	357-853-575	21509	387
24405739	22024	NI 10	26398-ED000	21850	NI 25	33111-SR3-A01	20601	204	357-853-585-A	21496	387
24405740	22022	NI 10	26557-2U001	21824	NI 24	33115-S84-A01	16897	203	357-853-586-D	20250	685
24449408	21540	107	2664040	14985	379	33115-S84-A01	B9005	208	358107	2272	357
2448770	16873	703	26717-89950	B1156A	206	33116-S2A-003	BH1	209	358470	9361	357
24501057	21090	373	26717-9B90E	B3057	206	33116-S84-A11	B9006	208	358501	8746	85
24574578	14988	522	271022	10773	81	33116-SLO-003	BD2C	208	358560	19626	691
2477054	8895	239	2711-0613	17429	250	33116-ST7-003	BD2S	209	358560	19627	691
2486468	17434	550	27158-Q0100	17634	366	33116-ST7-003	BD2S	209	3588314	13541	195
2495701	8938	240	274004	18472	201	33165-SAA-003	BH11	209	36000148	15666	682
2496279	9905	174	274007	18473	201	332364	10831	371	36001966	15666	682
24A	B24A	206	2745108	20675	548	332364	16259	371	362069	11638	53
24NA	18018	201	2771-0613	17425	250	33303-S30-003	19206	201	362379	11245	462
25015169	12237	174	2771-0817	17427	250	33303-SD4-671	16901	201	363137	15461	401
2501569	12237	174	2771-0824	17428	250	33303-SL4-003	19206	201	363137	16017	401
25016383	11612	366	2774-0613	17421	250	333-867-633-4FB	21451	687	3652	20298	202
25016383	11680	366	2774-0617	17422	250	3357	B3357	206	365270	11718	463
25099299	20163	494	2774-0817	17423	250	3357	18477	201	3655015	4233	339
25117765	18925	178	2774-0824	17424	250	3357A	B3357A	206	3664645	4237	338
2524525	8419	535	27948-M7002	14348	384	3357NA	18478	201	3671410	12918	132
2534814	14461	722	279670	12523	86	34201287	16826	36	367291	14976	61
25508532	12566	468	279670L	12521	86	34201358	15331	64	367292	12995	97
25512081	12729	497	279670R	12523	86	34201545	12993	366	367292	12996	97
25512688	19162	105	279671	12521	86	34201621	12567	487	3673945	12918	132
25514221	11675	367	2852065	20156	559	34201631	18108	245	3688699	8963	722
25522466	9285	232	293	18467	201	34201872	19276	536	3688811	4235	338
25524005	14004	245	2945108R	20675	548	34202159	17495	65	3689084	4236	339
25525798	14220	468	2945109	14967	548	34202672	13993	489	3691590	10831	371
25526447	19435	468	2945109L	14967	548	342271	16253	99	3691590	16259	371
25527289	14822	102	2962447	8774	153	3426388	2272	357	3693099	14217	497
25530441	14527	104	2962448	8777	153	34301-692A-0000	14317	585	3693292	4250	339
25535963	19472	495	2962510	11440	182	343543	11246	462	3696693	10843	346
25536302	14820	500	2962953	17115	157	343555	11243	462	37	18465	201
25552852	18422	474	2962984	8775	153	343555	11245	462	370247-S2N	5586	105
25552853	18423	474	2962987	8776	153	343555	11246	462	370374-S	4248	338
25552856	17979	473	2964547	11129	365	34355-SD2-003	15997	578	3711168	4265	338
25554845	19361	470	2965142	15957	153	3441734	12930	131	3722635	2619	692
25556911	19166	105	2965470	14892	157	3441743	12930	131	3722635	12958	692
25573616-10	12585	638	2965580	15504	157	3454220	15673	548	372741-S100	9864	215
25601491	18174	369	2971962	15956	153	3454221	15674	548	372820-S36	12654	260
25603960	18389	365	2973215	18690	154	3455559	11253	464	372820-S40	12654	260
25605716	14527	104	2973216	18651	154	3457	B3457	206	373528-S32	5854	100
25609048	17641	258	2973932	9905	174	3457	20587	202	373846-S	12918	132
25618730	17121	257	2974309	8756	175	3457A	B3457A	206	3744734	10843	346
25630330	19389	474	2977373	11442	182	3457NA	20588	202	3744750	12237	174

O.E.M. INTERCHANGE BY NUMERICAL ORDER

O.E.M. No.	Auveco No.	Page No.	O.E.M. No.	Auveco No.	Page No.	O.E.M. No.	Auveco No.	Page No.	O.E.M. No.	Auveco No.	Page No.
3744999	2752	692	3843245	12598	195	3923948	10090	464	4241296	12930	131
3744999	12960	692	3843345	12628	163	3927320	9481	150	4241362	12916	132
3745361	4280	338	3843386	16349	156	3944866	9965	691	4275973	13465	547
374985C1	9905	174	3843392	12627	163	3944866	12971	691	4-29-29-06	13198	368
3751212	12923	132	3843432	13233	195	3946988	2710	1	4304729	16804	156
375203-S	17467	254	384432-S	19459	256	3960314	10362	21	4307218	12943	133
375372-S	5592	383	3846202	15783	22	3963228	11738	132	4336115	17167	550
375480-S100	5195	100	384931-S36	17035	22	3977775	11130	377	4339372	21022	350
375480-S102	5195	100	385189-S100	11620	251	3982098	8359	106	4341060	17004	378
3757NALL	20859	202	385189-S100	16837	251	3984469	10653	4	4368618	15499	154
375890-S102	11293	100	38529-689A-6300	14323	386	3985058	11424	466	4370138	17101	246
375936-S	17469	253	385323-S100	11621	252	3986997	11109	22	4381995	20316	374
3759944	18770	365	385323-S100	16838	252	3997391	14030	466	4389940-AB	21670	540
3762180	4280	338	385330-S	11136	382	3998009	15759	503	4389947-AA	21376	546
376337-S100	9853	18	385353-S	12210	341	3A0-853-575	21478	684	4400588	13542	195
376337-S100	9854	18	385400	15345	82	3A0-853-575-A	21448	683	4417599	8447	693
376337-S100	9855	18	385661-S	11351	373	3B0-853-575	21449	683	441863987B	21485	688
3764554	9469	501	385677	19425	380	3B0-853-576	21447	683	4428987	19155	378
3764863	12599	195	385974-S	19460	258	3B0-868-243	20341	402	4437565	12237	174
3764865	12598	195	3861577	11347	368	3C0-853-585	21761	NI 31	443-853-909-A	21491	683
3767196	18979	345	3861577	11679	367	3M8Z-1502316-A	20923	522	444613	9278	232
376785-S2	15351	82	386299-S	16954	529	3M8Z-16K262-A	21304	516	444619	9279	232
376988-S2	10654	4	3863669	8942	465	3M8Z-17C432-A	21300	515	444620	9279	232
377537-S	16039	6	386553-S	19655	378	3U2Z-12S411-FKAA	20847	186	444667	9285	232
3775994	18770	365	3866846	15345	82	3U2Z-14S411-FKAB	20847	186	444776	9283	232
3783002	5278	35	387042-S	12939	133	3U2Z-14S411-HZA	20848	185	444777	9283	232
3783006	5228	38	387065-S	12932	133	3U2Z-14S411-HZB	20848	185	444782	9284	232
3783794	5195	100	387074-S	12933	133	3U2Z-14S411-KGA	19885	193	444789	9285	232
378527-S100	17470	254	387182-S	11671	390	3U2Z-14S411-SLB	20845	193	445429	11292	102
37888	12525	86	387258-S	11679	367	3U2Z-14S4AA-SLA	20845	193	4457495	10220	471
37889	12524	86	387466-S	12209	341	3W7Z-5422008-AA	18890	532	4457595	10220	471
37891	12523	86	387477-S	11797	391	4000141	11697	551	4459049	9342	362
37892	12521	86	387496-S	11672	401	4001916	18508	382	4486948	11157	175
379046-S	8427	37	3876130	16240	99	4001934	13467	379	4490167	9477	483
379830-S	9862	513	387843-S	11705	524	4003120	13004	99	4492962	10318	472
379830-S	14755	513	387944-S	11706	524	4003672R	20675	548	4492962	11288	471
379830-S	14756	513	387980-S	12948	133	4003673L	14967	548	4495047	9367	501
379831-S	8814	107	388034	12919	132	4004569	10831	371	4498100	14552	550
379831-S	10052	107	388047-S100	11852	251	4004569	16259	371	45262	10048	106
3799089	14858	547	388047-S102	12653	251	4005099	11349	400	45262	18898	106
380370	8418	39	388047-S1021	11852	251	4005250	11350	376	45263-S101	10050	106
380382	9829	465	388047-S1021	12653	251	4005470	11678	401	45263-S2	10050	106
380575-S2	8847	22	388131-S	12925	132	4005540	11152	348	45264	10053	106
380613-S	4439	131	388246-S	11612	366	4005714	15813	347	45264-S2	12265	106
380614-S	4440	341	388248-S-36B	11768	102	4006204	11470	463	45265-S2	10054	107
380615-S	12209	341	388442-S100	12652	261	4006316	13965	100	45267	10051	106
380707-S	11368	39	388442-S309	12652	261	4006516	11612	366	45268-S2	8814	107
380707-S	11370	37	388577-S	11146	371	4006529	15040	369	45268-S2	10052	107
3816659	10649	219	388577-S	15414	371	4006848	12943	133	45269	10055	107
381671-S	10642	26	388664-S100	14127	258	400764	4473	340	45332	15347	82
381801-S2	15774	27	388904-S	20316	374	400765	4474	340	45334	15345	82
381818-S2	9880	104	388908-S	14163	378	4019472	12943	133	4533699	8583	347
381863-S2	9879	104	388908-S	19655	378	40224-21001	14253	85	454626	16919	201
38211-SD2-000	15932	171	388916-S	12908	341	40224-EJ20A	14253	85	454645	16925	201
38212-SE0-000	15933	171	388930-S	12909	375	4023030	4204	339	454646	18004	201
382163-S	19826	102	389129-S	12907	341	4033711	14552	550	455136	16920	201
382413-S2	17460	28	389138	12937	131	4040732	18509	379	455490	16918	201
382413-S9	17460	28	389144-S	17075	391	4055028	13542	195	4563173	4240	339
382443-S	4439	131	389258	10831	371	407217	11110	22	4564974	4264	339
3828472	18329	257	389358-S	10831	371	4081765	4188	338	4565415	4240	339
383000	12929	131	389358-S	16259	371	4095145	12929	131	458030	12316	510
383000-S	12929	131	389360-S	11865	467	409988	4417	332	45998051	12119	66
383001-S	12930	131	389390	10330	465	4100727	12932	133	46064AE000	21593	654
383001-S	12930	131	389443-S	12571	373	4104998	12937	131	4630088	18031	245
383003-S	12937	131	3895904	12923	132	4114785	12134	358	4630088	18028	245
383005-S	12931	131	389809	13757	379	4114K	B4114K	206	4630253	18029	541
383016	12916	132	3899596	14030	466	411700	11721	366	4630660	18031	245
383031	12927	133	390018-S	17664	371	4124721	12598	195	4636359	18919	195
383033-S100	10780	357	3900684	4369	339	4-131-508-M	13230	628	4636360	18921	195
383033-S100	11863	357	3901067	19932	563	4137121	4242	338	4636361	18920	195
383033-S101	10780	357	390126-S	14017	366	413945	8744	85	4636362	18920	195
383033-S101	11863	357	390126-S	14857	366	414188	19168	85	4637277	20175	691
383142-S	20310	524	390428-S100	17410	257	4157	B4157	206	4638136	14753	485
383207-S	14217	497	390523-S	15675	532	4157K	B4157K	206	4638136	14993	486
383229-S	11104	253	3907444	8435	39	4157LL	20620	202	463-988-02-78	20735	400
383229-S	11105	253	3907444	11719	39	4157NALL	20621	202	4657731	2628	348
383229-S	11106	253	391304-S100	17606	331	416629	12069	359	4658444	19191	548
383255-S36	16770	82	391305-S100	17607	331	4167810	12920	132	4658673	19149	366
383356-S	14756	513	391396-S100	17604	331	4179981	12946	132	4658676	20675	548
383569	8623	18	391397-S100	17605	331	4179982	12944	133	4658677	14967	548
383569	8624	18	3919773	11691	466	4198993	16729	549	4658887	20165	365
383569	8625	18	3920179	11352	498	4201198	12934	132	4676189	19807	692
383847-S	11419	133	3921446	9851	464	4234830	15518	503	4676356	19339	549
384111-S	12949	133	3921988	19130	223	4241054	12939	133	4689929	2744	691

O.E.M. INTERCHANGE BY NUMERICAL ORDER

O.E.M. No.	Auveco No.	Page No.	O.E.M. No.	Auveco No.	Page No.	O.E.M. No.	Auveco No.	Page No.	O.E.M. No.	Auveco No.	Page No.
4689929	2818	691	51-11-1-908-077	20234	576	51-71-7-066-223	22142	NI 14	55022134	15042	493
4689929	12962	691	51-11-1-942-789	21861	NI 6	51-71-7-066-226	22092	NI 15	55054844	15666	682
4696129	18033	381	51-11-1-944-537	20734	576	51-71-7-066-299	22091	NI 15	55055098	18248	382
4696488	14995	485	51-11-7-160-451	21782	NI 14	51-71-7-127-742	21716	NI 23	55075139	17214	485
4699315	2619	692	51-11-8-174-185	20248	576	51-71-8-184-574	21765	NI 14	55156429-AA	20523	539
470433	20795	342	51-11-8-400-709	21844	NI 5	51-71-8-259-788	21781	NI 16	55156447-AB	20700	540
470434	20796	342	51-12-7-004-445	21777	NI 15	51-75-7-271-848	22084	NI 14	55156655-AA	21738	NI12
4717224	19855	370	51-12-7-070-202	22113	NI 3	51-77-7-171-002	21787	NI 15	55156879-AB	20962	538
4721222	4281	340	5113015-AA	18032	541	51-77-7-171-002	21787	NI 15	55157055-AA	20700	540
4723818	2789	692	51-13-1-804-205	13158	574	51-77-7-171-003	21776	NI 15	55157055-AA	20887	541
4723818	12961	692	51-13-1-829-904	21767	NI 13	51-77-7-171-004	22147	NI 6	55157065-AA	20887	541
472434	11699	487	51-13-1-885-399	16115	576	5189180-AA	21154	539	55157069-AB	20827	540
472450	15453	340	51-13-1-960-054	21429	575	5189181-AA	21155	541	55157070-AC	20828	539
472812	12935	131	51-13-2-251-394	21430	575	5208743	15040	369	55157112-AB	20890	546
472814	12921	132	51-13-6-440-146	21767	NI 13	52115-0C090	21221	660	55157112-AB	20890	546
472815	12922	132	51-13-8-124-389	20254	575	51-15-48040	21132	660	55157330-AC	20940	546
4730773	20175	691	51-13-8-166-675	21432	575	52161-02020	18873	677	55176248	14020	526
474821	14976	21	51-13-8-231-130	21766	NI 13	52161-16010	18873	677	55256967-AC	19816	345
4755299	8435	39	51-14-1-807-495	20186	575	52161-20010	20931	677	55350747-AB	19775	399
4759145	2943	691	51-14-1-902-279	20186	575	52197-22020	22096	NI 28	554343	11831	498
4759514-AB	20356	538	51-16-1-881-149	20187	628	52197-22020	22096	NI 28	55568037	21650	225
4761842	2943	691	5116530-AA	20966	544	52197-30040	21682	NI 29	556196	11665	463
4767559	4446	339	5116530-AA	20990	490	52197-52010	21133	660	556539	11667	463
47749-50090	21357	611	51-18-1-821-830	18156	35	52-20-8-238-999	13167	575	556992	12932	133
47749-58010	20757	667	51-21-6-442-159	13167	575	52535-0E010	21015	665	557057	11655	463
4778814	2744	691	51-21-8-205-295	20388	576	52535-0E030	21712	NI 27	557057	11871	464
4778814	2818	691	51-32-1-938-884	21223	574	52535-30150	21583	665	557057	12605	463
4778814	12962	691	513388	4243	338	52535-30150	21583	665	55799-12010	19841	665
4779348	2943	691	5134937-AA	20861	553	52535-50060	21015	665	558	20288	202
4784018-AA	21231	537	51-41-015-44-20	21764	NI 14	5255110	18979	345	55914-S2	13021	31
4801268	3620	382	51-41-0-407-984	21788	NI 15	52599-0E010	21084	610	559312	11655	463
4805336-AA	19642	537	51-41-0-407-984	21788	NI 15	528846	13004	99	559312	11871	464
480534	10832	371	51-41-1-802-258	13170	67	5297428	18952	148	559547	11836	467
4805405-AA	19638	546	51-41-1-973-500	20253	401	53	B53	206	56001419	15666	682
4805405-AB	19638	546	51-41-700-16-29	21764	NI 14	53	16914	201	560625	12937	131
4805570-AA	20526	549	51-41-8-172-050	13179	400	53041045	16873	703	560692	11419	133
4806110-AA	20767	545	51-41-821-58-06	21762	NI 14	53130	12657	259	561	18010	201
4806226-AA	21187	498	51-41-8-224-768	21788	NI 15	53145-16020	18846	665	562	20289	202
4806240-AA	20768	544	51-41-8-224-768	21788	NI 15	53181	12654	260	562327	11831	498
4806240-AB	20768	544	51-43-7-001-491	21138	395	53259-0E010	21525	614	568792	19626	691
4806271-AA	22028	NI 12	51-43-7-194-187	22109	NI 14	53271-0B010	22102	NI 31	568792	19627	691
4806334-AA	20963	546	51-44-7-780-135	21499	575	53271-0B010	22102	NI 31	56910-S2	13025	27
4853108	8398	693	51-45-030-47-03	21764	NI 14	53271-12040	22102	NI 31	56910-S424	13025	27
4857345-AA	20457	545	51-45-0-396-330	21763	NI 14	53271-12040	22102	NI 31	56911-S2	13711	28
4857699-AA	20771	541	51453-0E010	21860	NI 30	53271-12060	22102	NI 31	56911-S36	13711	28
4857751-AA	20769	537	51453-0E010	21860	NI 30	53271-12060	22102	NI 31	56911-S61	13711	28
4860375-AB	20667	537	51453-48010	21860	NI 30	53271-44010	22078	656	56912-S	13026	28
4860379-AA	21026	371	51453-48010	21860	NI 30	53326-08010	21211	378	56929-S2	13711	28
4872948	4446	339	51453-48010	21860	NI 30	53384-68010	22126	NI 29	57	B57	206
4876498	10744	379	51453-48010	21860	NI 30	534343	11831	498	57	16910	201
4877000	8385	693	51454-0E010	21856	NI 30	53452-90351	17611	679	57030-S36	17034	27
4877001	8386	693	51454-0E010	21856	NI 30	53455-14020	14732	679	5706	15018	87
4878883-AA	20164	378	51454-48010	21856	NI 30	53455-33010	19529	679	5715	15017	87
4879431	9229	27	51454-48010	21856	NI 30	53455-33011	19529	679	5716	15015	86
4879481	8448	693	51-45-8-161-557	21763	NI 14	53813-48011	22132	NI 29	57160FC000	21568	655
4883164	8399	693	51-45-816-52-60	21764	NI 14	53813-48011	22132	NI 29	57160FC010	22042	NI 26
4886720	8447	693	51-45-8-266-814	21775	NI 14	53857-47011	22103	NI 29	57172C91	11156	175
490067	11770	19	51-46-7-002-606	21779	NI 16	53857-47011	22103	NI 29	5735-L	15004	86
490067	11771	19	51-47-1-840-961	13172	574	53867-47020	21237	667	574355	19626	691
4956-A	15017	87	51-47-1-881-521	21851	NI 15	53879-14010	14750	680	574355	19627	691
4963	15015	86	51-47-1-919-209	22052	NI 16	53879-14010	19669	680	575411	2789	692
4A0-805-121-A	21515	685	51-47-1-945-266	21777	NI 15	53879-14020	14750	680	575411	12961	692
4A0-805-163	21815	NI 33	51-47-2-499-935	21851	NI 15	53879-14020	19669	680	57728AC090	19246	646
4A0-853-825	21492	683	51-47-7-117-532	22090	NI 15	53879-17020	21359	680	57750AA090	21578	655
4A0-853-825-A	21493	682	51-47-8-116-564	21851	NI 15	53879-20020	21613	681	57750FC010	21577	652
4A0-853-825-C	21481	683	51-47-8-166-992	21780	NI 16	53879-22010	14276	681	588546	15037	27
4A0-867-276	21818	NI 36	51-47-8-183-031	21851	NI 15	53879-22030	14750	680	59122AC030	21580	655
4A0-867-276A	22108	NI 33	51-48-1-884-779	22052	NI 16	53879-30040	21797	NI 31	59122FA010	21571	654
4D0-807-300	22101	NI 32	51-48-1-915-964	20270	576	53879-30040	21797	NI 31	591-740	12637	689
4F0-805-163	22098	NI 31	51-48-1-938-725	20270	576	53879-50020	21358	610	5949838	3178	464
4F1Z-9A317-AA	21214	529	51-48-8-181-420	21757	NI 14	53879-58010	20758	667	5963268	11156	175
4L0-886-373	22094	NI 33	51-49-0-151-605	22057	NI 15	53879-58010	20758	667	5970995	16230	97
4L3Z-1503296-AB	20836	345	51-49-8-105-79	22057	NI 15	53879-60010	20335	676	5973400	12757	487
4L3Z-1510182-AA	20862	518	51-49-8-123-832	22057	NI 15	53888-48010	21225	677	5973823	19847	487
5008055-AA	20309	352	5159077-AA	20964	538	53935-35020	21162	660	5973996	12756	488
5010366-AA	19791	553	5159077-AB	20964	538	54229-0201P	16340	347	5988-L	15010	86
5012874-AA	19628	398	5160260-AA	20966	544	547944	4439	131	5988-L	15010	86
5023111-AA	19804	400	516637	8744	85	5480772	20863	492	5988-R	15009	86
5023173-AA	20563	399	51-71-1-496-621	21143	380	5480852	20756	479	5988-R	15009	86
5023351-AA	19804	400	51-71-1-916-199	17646	575	05480853	8889	239	58B14LX9	19245	545
5028438-AA	20428	398	51-71-1-958-025	22087	NI 13	5482087	21284	498	5C3Z-13466-AA	18016	201
5073327-AA	20187	628	51-71-7-002-953	20754	245	5482103	20881	387	5C3Z-13466-AA	18465	201
5102247-AA	20861	553	51-71-7-006-757	22140	NI 14	549790	11640	53	5C3Z-13N021-AA	BH13	209
5103921-AA	20637	629	51-71-7-066-220	22141	NI 14	55	20282	202	5F7Z-13466-B	20285	202

O.E.M. INTERCHANGE BY NUMERICAL ORDER

O.E.M. No.	Auveco No.	Page No.	O.E.M. No.	Auveco No.	Page No.	O.E.M. No.	Auveco No.	Page No.	O.E.M. No.	Auveco No.	Page No.
5FR56DX9	19894	539	6032061	12566	468	6288704	8777	153	6502689	18501	245
5FR56XX-AB	19894	539	6032083	16851	82	6292995	12629	163	6502738	17353	85
5GC71RC3-AA	20273	524	6032138	16687	255	6292995	15372	163	6502745	16868	703
5GF92RC3-AA	20273	524	6032363	11351	373	6294493	13548	182	6502776	18102	529
5R3Z-54310D12-AAA	21024	525	6032516	13466	38	62955-12010	15695	657	6502842	17975	378
5R3Z-54310D12-BAA	21560	368	6032856	17615	254	62955-20020	15695	657	6502871	14992	522
5U2Z-14S411-ZB	20842	191	6032926	12655	252	6298886	9883	174	6502907	17669	397
6000258	19537	100	6032926	14486	252	6298886	11166	174	6502988	19519	499
6000558	10073	100	6033082	17664	371	6298886	13558	174	6502991	17685	399
6000605	5854	100	6033560	15345	82	6298892	9883	174	6503106	18269	545
6000705	2619	692	6033677	14756	513	6298892	13558	174	6503108	18034	536
6000705	12958	692	6033688	18810	260	6298935	9883	174	6503163	14997	485
6000720	2752	692	6033840	17664	371	6299087	11157	175	6503204	18862	398
6000720	12960	692	6033862	11349	400	63	20283	202	6503221	12766	374
6000943	8419	535	6034213	10375	82	631	18468	201	6503336	21023	403
6000943	8719	719	6034336	19310	549	63-21-7-160-777	BH1	209	6503339	18249	547
6000943	9377	535	6034376	18373	223	63-21-7-160-780	BH7	209	6503373	18825	537
6002893	10622	349	6034703	18934	32	63-21-7-160-806	BD2S	209	6503401	19417	61
6003147	11354	539	6034812	19310	549	63-21-7-217-509	BD1S	208	6503433	18375	225
6003219	13616	538	6034848	19657	254	63844-01A00	16858	646	6503453	18394	546
6003220	8853	380	6034944	16988	247	63844-01A99	14726	645	6503454	18327	543
6003349	11678	401	6035094	2562	82	63844-D0100	14727	648	6503598	17216	491
6003351	11136	382	6035188	18934	32	63846-5V000	21768	NI 24	6503709	19213	389
6003409	20276	349	6035201	17639	261	63846-9E000	20813	642	6503768	18301	370
6003423	11673	373	6035201	19263	261	63848-01G00	16782	595	6503800	13748	245
6003587	11675	367	6035274	14037	468	63848-35F00	19735	649	6503812	19779	549
6003609	12794	538	6035401	20179	536	63848-40Y00	20613	646	6503819	19417	61
6003632	11936	539	6035414	19406	254	63848-9E001	20327	646	6503837	18531	81
6003752	20276	349	6035417	18373	223	63848-9Y000	21664	649	6503860	17101	246
6003774	13927	538	6035807	19310	549	63848-D0100	17193	649	6503892	18827	377
6003858	13847	539	6035821	20524	537	63848-D4000	17385	649	6503938	18913	245
6003861	13843	538	6036148-AA	20629	256	63848-D4001	17385	649	6503943	20189	372
6003873	13845	539	6036310-AA	18163	85	63854-01A00	17472	647	6504014	17669	397
6003878	20276	349	6036747-AA	18163	85	63876-95596	16000	596	6504014	18915	397
6003965	13927	538	60658-SB3-000	17289	598	63878-01E10	20348	646	6504018	19141	225
6004036	17151	539	60658-SD2-000	17289	598	645350	1256	357	6504043	17612	371
6004162	17064	539	6100042	11629	109	6466355	12920	132	6504072	19793	536
6004212	14005	245	6100047	19216	64	6500092	12617	85	6504090	12567	487
6006264	3404	83	6100048	15329	64	6500284	15329	64	6504098	19338	376
6010029	19626	691	6100049	15331	64	6500361	14561	550	6504135	19541	373
6010029	19627	691	6100050	15333	64	6500526	12715	85	6504424	18375	225
6010046	2752	692	6100539	12232	51	6500650	15860	703	6504452	17669	397
6010046	12960	692	6100567	19455	52	6500651	15861	703	6504521	19422	544
6010093	2744	691	6100568	15818	52	6500722	15862	703	6504555	17222	488
6010093	12959	691	6100775	12254	66	6500787	14016	488	6504601	19779	549
6013029	2619	692	6100810	12115	66	6500859	13754	245	6504700	13750	246
6013029	12958	692	6100811	12253	66	6500898	13755	245	6504870-AA	19809	105
6013122	11677	402	6100814	19548	66	6500911	13750	246	6505149-AA	18531	81
6023171	10053	106	6100815	16829	66	6501025	12125	66	6505161-AA	19640	536
6023204	15345	82	6100839	12122	66	6501067	15481	373	6505292-AA	19386	397
6023718	18811	239	6100840	12123	66	6501086	20316	374	6505411-AA	10831	371
6023925	8242	39	6101283	11629	109	6501220	19718	60	6505417-AA	19836	366
6025004	15345	82	6101308	18449	108	6501301	16818	369	6505534-AA	20829	389
6025005	15347	82	6104900-AA	21086	629	6501415	16980	66	6505539-AA	19628	398
6025007	15350	82	6104908-AA	18302	365	6501509	18242	245	6505667-AA	20360	372
6025329	9480	21	61118-35010	21194	657	6501559	13751	246	6505703-AA	20267	536
6026166	16237	99	614	12629	163	6501577	17106	488	6505759-AA	20427	399
6026430	9299	82	616	12628	163	6501590	14019	526	6505813-AA	18934	32
6026723	10655	18	61991-35010	21234	660	6501630	17104	542	6505863-AA	20420	547
6026723	10656	18	61992-35010	21235	660	6501699	17354	537	6505878-AA	17124	389
6026723	10657	18	62217-13010	20558	392	6501772	17104	542	6505918-AA	20515	397
6026958	10086	82	62217-33031	22158	NI 29	6501773	12569	514	6506007-AA	13751	246
6027924	10080	548	62228-51S00	19147	649	6501825	12259	66	6506008-AA	19639	489
6027958	19485	39	62228-7Y000	21108	639	6501878	17104	542	6506104-AA	20173	549
6029348	16852	82	622A2-9E000	21361	493	6501916	15543	372	6506132-AA	20458	545
6029501	12735	466	622A2-9E000A	21361	493	6501925	18030	489	6506161-AA	19278	59
6030441	11146	371	62318-01W00	16860	637	6501948	19893	368	6506214-AA	19141	225
6030441	15414	371	62319-0W000	20266	639	6502081	16871	703	6506306-AA	20623	547
6030441	18815	367	62380-U7400	17196	641	6502083	16872	703	6506807-AA	21035	548
6030538	10832	371	62581-14020	16778	400	6502085	16873	703	6506852-AA	20468	537
6031091	11621	252	6263345	11138	470	6502087	16874	703	6506852-AB	20468	537
6031091	16838	252	62660-48600-1	20381	384	6502089	16875	703	6507055-AA	20765	398
6031115	11620	251	62698-V7000	14313	586	6502089	16876	703	6507669-AA	20766	545
6031115	16837	251	6270163	10832	371	6502090	16877	703	6507686-AA	20765	398
6031147	8865	82	6271903	20801	342	6502091	16878	703	6507741-AA	21354	224
6031183	14218	536	6271904	20803	342	6502104	18771	374	6508072-AA	21236	535
6031234	13647	536	6271905	20802	342	6502152	16846	108	6508197-AA	21098	523
6031321	10831	371	6271906	20804	342	6502328	14921	365	6508365-AA	20623	547
6031383	11704	542	6271989	14559	508	6502381	18815	367	6508444-AA	21446	245
6031390	11699	487	6272766	12918	132	6502450	16876	703	6508540-AA	21418	253
6031438	12995	97	62731FA000	21629	652	6502491	16870	703	6508643-AA	21348	546
6031438	12996	97	62731FA010	21587	652	6502545	18237	547	6508712-AA	20888	490
6031869	12713	468	6280765	3617	362	6502573	18032	541	6508727-AA	21257	372
6031875	19152	548	62869-N4700	14723	385	6502625	16835	486	6508746-AA	14010	487

O.E.M. INTERCHANGE BY NUMERICAL ORDER

O.E.M. No.	Auveco No.	Page No.	O.E.M. No.	Auveco No.	Page No.	O.E.M. No.	Auveco No.	Page No.	O.E.M. No.	Auveco No.	Page No.
6508863-AA	20988	489	680-097	13191	690	75305-SH2-003	20784	579	76817-12060	21612	659
6508947-AA	21153	540	68009867-AA	21105	386	75305-SH2-003	20784	579	76847-1JB0A	22055	NI 24
6509049-AA	20880	490	68033794-AA	21442	547	75305-SH4-003	20785	579	76848-54C00	22059	NI 23
6509103-AA	19801	489	68034329-AA	21442	547	75305-SH4-003	20785	579	76848-71500	21622	641
6509106-AA	21019	549	68039280-AA	21528	541	75305-SHJ-003	21186	578	76848-8J010	20786	641
6509288-AA	21223	540	68061648-AA	21329	395	75305-SM4-A01	21556	579	76853-10010	21586	659
6509539-AA	21865	NI 2	68084593-AA	21213	537	75306-SDA-A01	20782	581	76876-W5000	14352	383
6509590-AA	21679	NI 12	68092697-AA	20870	540	75306-SV1-A01	20602	579	76879-44010	21611	680
6509960-AA	21680	NI 13	68211-06020	19531	659	75306-SZA-A01	21470	578	76881-0P000	20166	641
65613-07010	21337	680	68211-07010	19380	659	75307-SN7-000	20570	65	76881-9E000	19897	639
65624-V0100	14337	648	68211-95D00	19722	661	75315-S9A-004	22136	NI 17	76882-0E700	21617	638
65722-EA000	21309	648	68213168-AA	21791	NI 12	75315-STK-A01	21204	567	76882-0M000	21017	649
65810-K2000	21229	381	6822 LL	21822	NI 35	75316-S9A-004	21557	578	76882-0M060	21619	637
65810-K2002	22060	NI 25	6822 LL	21822	NI 35	75316-S9A-004	21557	578	76882-57A00	18265	645
65810-K2009	19724	382	68225214-AA	21835	NI 12	75329-SH4-O13	21109	579	76882-6P000	20886	601
65832-F5000	17237	378	68425-H5000	14313	586	75392-04010	21016	659	76882-6P010	22076	NI 24
65846-30F00	17237	378	69293-12030	20469	679	75392-0R010	21016	659	76882-EG01A	21285	637
65846-40F00	19468	376	69293-12040	20470	679	75392-35200	21016	659	76882-EW00B	21683	NI 24
65846-42000	17237	378	69293-12050	20534	679	75392-35220	21857	NI 27	76882-JG10A	22061	NI 24
65846-42000	19468	376	69293-12060	20535	679	75392-35220	21857	NI 27	76884-90100	12583	638
65846-42000	21288	376	69293-30030	21336	679	75392-42030	21841	NI 2	76906-T3000	14353	386
661179000	22044	NI 26	69293-33010	20469	679	75392-60030	20877	608	76923-47010	22072	NI 31
66421-634-000	14291	383	69293-33020	20470	679	75392-60031	20877	608	76923-47010	22072	NI 31
66435-648-000	14291	383	693005370	21584	392	75393-60030	21314	608	76924-02010	20578	659
66435-648-0000	14291	383	6973.A9	21813	NI 35	75394-60060	20875	608	76924-47010	21217	660
66814-01600	16725	448	6983.17	21809	NI 35	75395-0T010	21453	657	76924-47020	22073	NI 30
66820-3S500	20672	388	6991.S6	21814	NI 34	75395-14020	14264	659	76924-52021	20578	659
66820-3S510	20614	638	6991.S6	21814	NI 34	75395-33030	19900	608	7693140	9639	347
66820-61U00	21689	NI 25	6992.31	21808	NI 35	75395-35070	20688	658	76988-3DNOA	22032	NI 24
66820-88E00	17633	642	69951-12180	18113	639	75396-30260	21699	NI 27	76988-3J000	19736	641
66820-9N00A	22128	NI 25	6997.T2	21810	NI 35	75396-35020	20687	658	76988-4N000	21291	637
66820-AX020	21159	645	6E5Z-13466-AC	B4157K	206	75397-33010	20661	608	7698976	9633	347
66824-01600	16783	645	6E5Z-7850980-AAA	21024	525	75397-35010	20688	658	76996-01P02	16776	369
66824-W1000	14725	647	6G1Z-5410182-A	20977	520	75397-48010	19899	608	76997-P7100	14723	385
66860-01W01	16859	645	6G1Z-5410182-C	20979	518	75397-48030	20605	608	77-03-072-360	21807	NI 34
67	B67	206	6K0-868-243-C	21398	403	75492-60030	20876	608	77-03-072-416	21812	NI 34
67	16905	201	6N0-809-966A	21816	NI 35	75495-35010	20687	658	7703-077-066	12993	366
673-988-00-25	20315	627	6N0-823-397-AC	21514	688	75498-42010	19843	658	77-03-077-080	21800	NI 34
67771-01010	14144	396	6Q0-868-243	21251	688	75521-611-000	14274	664	77-03-077-225	21806	NI 34
67771-02030	15709	396	6Q0-868-246-A	21760	NI 32	75521-611-0000	14274	664	77-03-077-231	21802	NI 34
67771-02030	15709	396	6Q0-868-297	21783	NI 32	75522-611-000	14255	585	77-03-077-435	21805	NI 34
67771-02030	19898	396	6W1Z-5422008-A	18890	532	75545-12050	15475	661	77-03-077-468	21814	NI 34
67771-03030	15707	396	701-867-299	21479	687	75545-14081	14747	663	77-03-077-468	21814	NI 34
67771-04040	19210	397	703-867-299	21450	388	75545-16020	14751	662	7724826	4447	339
67771-06010	18844	395	71144-SR3-A00	18415	588	75545-24030	19776	608	77259-71800	20744	656
67771-06030	19109	393	71591-S5A-000	21636	580	75545-28010	14749	663	7730788	9749	347
67771-12010	14269	395	71592-S5D-000	20603	578	75545-32020	16833	661	7731589	9850	471
67771-12010F	14269	395	71598-S30-013	20677	578	75545-32030	17485	661	7731589	10632	361
67771-12030	15709	396	72115-60A00	17356	499	75545-33010	21255	609	77553-65D00	20743	656
67771-12040	19016	397	72311-S10-003	19673	366	75545-53011	21255	609	77553-65D10	22079	NI 27
67771-12050	18898	106	72311-S5S-003	21704	NI 17	75545-53011	21505	609	78856-R4301	14690	586
67771-12050	19257	397	72311-S5S-003	21704	NI 17	75545-88080	14749	663	796255	11349	400
67771-12070	20473	388	72413-SF1-003	17270	580	75545-880B0	14749	663	79796-71E00	17349	638
67771-12080	20575	394	72413-SF1-0030	17270	580	75545-89101	16942	663	79896-P7100	14333	638
67771-14040	15707	396	72431-S2X-003	21639	579	75546-12030	16821	663	7L0-839-069	21512	683
67771-16080	19108	397	72727-W1000	15470	638	75546-12050	14746	662	7L3Z-9S317-A	21126	529
67771-16120	18874	397	72774-01F00	14331	639	75546-12060	19204	661	7L3Z-9S317-B	21127	528
67771-16160	18874	397	72826-01P00	15468	638	75546-22050	14745	662	7L5-853-994	21495	387
67771-16170	18875	388	73	20284	202	75546-22060	17334	661	7L6-868-243	21708	NI 32
67771-22010	14270	396	73156-SS0-004	17488	585	75547-22010	17298	662	7M0-867-299-K	21853	NI 32
67771-22020	14728	395	7368261	16801	156	75547-51021	21082	255	7M3867299	21853	NI 32
67771-30070	19109	393	73856-51E00	17348	638	75548-16010	17330	662	800843	12935	131
67771-30090	19129	398	73858-8J000	20873	637	75548-22150	19484	662	801471	12922	132
67771-32090	18844	395	73858-ZB00A	20873	637	75548-24020	14278	662	801-853-577	12635	682
67771-32120	21686	NI 30	73862-672-003	14299	379	75548-32010	14731	662	801-867-299-01C	21758	NI 32
67771-32120	21686	NI 30	73862-672-0030	14299	379	75791-0W010	15707	396	8-03536-966-0	18665	222
67771-58010	21369	657	74	18016	201	75791-33020	21008	659	803716-S	14018	526
67771-89104	19203	394	7440	B7440	206	75819-33010	21748	NI 28	803-853-139A	13189	682
67773-0E020	21795	NI 30	7440	19206	201	75867-02010	21226	671	803-853-139C	13174	682
67773-0E020	21795	NI 30	7440A	B7440A	206	75867-06030	21596	678	803916010	21326	226
67867-0C010	20443	381	7443	B7443	206	75867-21010	20576	387	807016160	21326	226
67867-12150	19749	381	7443	19207	201	75867-30110	19842	369	80850-89900	21633	381
67867-28030	18692	381	7443A	B7443A	206	75867-30120	21123	677	80850-CA003	21588	385
67867-50020	21694	NI 29	74798-S9000	14695	587	75867-30130	22056	NI 30	80850-CA003	21588	385
67867-89103	18692	381	74806-SB6-003	16825	585	75867-33030	21538	672	80850-JM01A	22107	NI 24
67868-30030	21627	365	74807-SB0-004	17454	584	75867-AA010	21012	388	80871-ST7-000	18141	331
67868-89101	18692	381	74842-659-003	16779	386	75867-AA010	21538	672	80872-ST7-000	18140	331
67869-12050	21551	386	74842-659-0030	16779	386	75867-AC020	21653	658	80873-ST7-000	18137	331
67869-20030	21548	365	75039-33010	19482	608	76222-SP1-003	21772	NI 16	80874-AX000	21646	648
67921-32010	19719	387	75039-33040	19492	607	76222-SP1-003	21772	NI 16	80875-85E00	18166	382
67A	B67A	206	75039-33060	19120	608	7634583	9275	347	80999-05N07	16784	677
68	B68	206	75049-33010	17989	607	7637192	4441	339	80999-VE000	20668	395
68	20292	202	75305-S0A-003	20783	579	7642589	13467	379	80999-VE000	21414	394
68004187-AA	21187	498	75305-S0A-003	20783	579	76647-42010	21616	680	81121-14670	16558	656

O.E.M. INTERCHANGE BY NUMERICAL ORDER

O.E.M. No.	Auveco No.	Page No.	O.E.M. No.	Auveco No.	Page No.	O.E.M. No.	Auveco No.	Page No.	O.E.M. No.	Auveco No.	Page No.
81121-17010	16558	656	87702-H1000	21244	599	8900524	11948	153	90009-R70-A00	20426	225
81124-89101	16951	656	87703-H1000	22013	NI 18	8901283	11166	174	9003	18661	203
81126-37010	20543	386	87714-FD200	21356	599	89023920	21168	558	9004	B9004	208
81137-22530	21628	663	87719-02500	22014	NI 18	89024363	20945	558	9004	16896	203
81150-1A750	21628	663	87719-3D000	21038	598	8902487	11446	175	9005	B9005	208
8-11519-408-0	21047	224	87756-1C000	21356	599	89025539	20485	504	9005	16897	203
8-11562-588-0	21047	224	87756-1F000	22015	NI 18	89025543	21092	504	9006	B9006	208
811-807-557-C	21510	684	87756-1F000	22015	NI 18	89025546	21072	504	9006	16898	203
811-807-577-C	21399	685	87756-26900	22016	NI 19	89026634	21385	377	9007	B9007	208
812893	12600	176	87756-2E000	21136	599	89026635	21386	377	9007	18662	203
8133-50-022	14380	386	87756-2G000	21312	599	8903202	11154	175	90075-10004	21628	663
81496-21010	21684	NI 28	87756-34520	22017	NI 19	8903202	11475	176	90075-10801	19783	517
81496-50010	22127	NI 28	87756-34520	22017	NI 19	8903283	11446	175	90075-10805	19783	517
8173-50-931	12589	616	87756-37000	22018	NI 18	8903488	12629	163	9008	BH13	209
8211.WV	21811	NI 35	87756-38000	20567	599	8903488	15372	163	90080-46010	21296	383
82315-22000	22004	NI 19	87756-3D000	20566	598	8903489	12628	163	90080-46269	19797	658
82315-27000	21188	392	87756-3E500	21484	605	8904437	11156	175	90080-46294	21325	676
82315-27000	21188	392	87758-35000	21064	599	8905087	15959	153	90080-81041	16897	203
82315-2P000	21070	393	87758-35010	21863	NI 18	8905794	20471	496	90080-82014	12540	172
82315-2P000	22003	NI 19	87758-35010	21863	NI 18	8909518	11156	175	90080-82050	21603	172
82315-2P000	22003	NI 19	87758-37000	21066	600	8909908	11446	175	90080-82051	21436	172
82315-33020	22005	NI 19	87758-39000	22019	NI 18	891	B891	207	90080-82051	21436	172
82315-33020	22005	NI 19	87758-3D000	20568	599	891	20598	204	90080-82052	21437	172
82315-36000	22006	NI 19	87758-3E000	22014	NI 18	8911472	14546	496	90080-82052	21437	172
82315-38000	21070	393	87758-3L000	21321	599	8911473	14544	496	90080-82053	21166	172
823-867-299	20252	400	87759-27000	21292	600	8911497	14545	496	90080-82055	21438	172
823-867-299	20252	400	87759-3E000	22014	NI 18	8912698	11157	175	90080-82055	21438	172
82711-12200	21553	680	87770-27000	22020	NI 18	8912750	13540	174	90084-26001	17420	250
83219-22000	22135	NI 18	8799350	10617	471	8913369	14885	157	90084-26002	20383	255
83501000	12599	195	880	B880	207	8914822	11154	175	90084-26008	17411	250
83504041	19318	223	880	20594	204	8914822	11475	176	90084-46020	21071	659
83942-65D00	22078	NI 27	881	B881	207	8914823	11476	175	90084-98033	18661	203
8411	15018	87	881	20595	203	8915135	12629	163	90084-98033	20601	204
84653-N7400	14337	648	88-10-0-141-180	B53	206	8915136	12628	163	90099-14044	18136	331
84747-2L000	22007	NI 18	884	B884	207	8917225	18451	157	90099-14045	18143	331
84747-2L000	22007	NI 18	885	B885	207	8917283	17002	153	90105-06037	21840	NI 1
84915-0W000	19731	394	885	20596	204	8917320	14547	496	90106-SW3-003	19650	588
84953-AU100	21640	396	886	B886	207	8917444	11083	166	90107-SOX-A01	21521	588
84953-JA00A	21289	395	886	20683	203	8917528	15959	153	90107-SOX-A01	21521	588
84995-3J101	21631	646	8880417	15672	542	8918527	9883	174	90107-S10-003	19533	588
85099-0B720	19293	640	88862264	21490	178	8918527	11166	174	90107-SX0-003	19734	588
85099-1VA0A	22123	NI 24	88891731	19424	508	8919916	13543	176	90108-SS0-003	20331	578
85222-0M000	20790	641	88891791	18889	259	893	B893	207	90108-SW3-003	19470	368
85222-0M00A	20790	641	889	B889	207	893	20599	204	90109-SW3-003	19470	368
85284-4J500	21701	NI 25	889	20597	203	8933059	10318	472	90114-SE0-000	20259	60
85284-75610	21160	602	88909758	12548	172	8933059	11288	471	90114-SZ3-000	20259	60
85284-AD000	21147	602	88909760	12536	172	8934-201-235	13464	650	90116-S82-A01	19439	577
85284-CD000	21117	638	88909760	12550	172	8934-201-262	11855	466	90159-50316	21839	NI 2
85495-2E050	22008	NI 19	88909761	12551	172	8934-201-263	9377	535	90159-60303	22106	NI 2
85495-2E050	22008	NI 19	88909762	12552	172	8934201287	16826	36	90159-60488	21838	NI 2
85506-4A000	22009	NI 19	88909763	12553	172	8934-201-493	16256	99	90159-60525	21837	NI 2
85506-4A000	22009	NI 19	88909764	12554	172	8934-201-602	12713	468	90159-A0001	21839	NI 2
85746-06000LX	21349	367	88909765	12555	172	8934-201-681	13475	400	90179-05060	17993	615
85746-06000RU	21350	367	88909766	12556	172	8934-201-767	13966	100	90183-03001	16306	680
85849-3B000	21360	394	88909769	12547	172	8934-201-835	17496	246	90189-04008	14277	664
86155-22000	17162	487	88909770	15505	172	8934-202-293	16251	99	90189-04011	14271	663
86155-2H100	21328	601	88909771	15506	172	8934-202-599	17102	390	90189-04013	14268	665
86155-2H100	21328	601	88909772	15507	172	8936000	15666	682	90189-04014	14256	663
86157-37000	21233	601	88909773	15508	172	8936001	15666	682	90189-04019	14263	665
86359-33500	21457	605	88909774	15509	172	894	B894	208	90189-04022	17224	663
86360-3L000	22010	NI 18	88938226	14921	365	8-94134-027-0	14739	664	90189-04031	18843	664
86434-4A000	21382	379	88953358	21033	181	8-94145-515-0	17076	372	90189-04057	14271	663
86438-2B000	18692	381	88953358	21542	181	8-94218-027-0	17195	632	90189-04059	21151	664
86438-4A100	21381	380	88969790	20576	387	8-94221-150-0	14727	648	90189-04066	14281	587
86438-4A100	21381	380	88970345	20559	393	8-94226-492-0	14269	395	90189-04102	21544	664
86590-28000	17632	523	88970494	20577	677	89427-98070	16775	371	90189-04150	19265	664
86590-35000	17143	597	88970495	20578	659	8-94298-119-0	14696	595	90189-04176	19840	664
86591-25000	21363	605	88970656	20575	394	8-94328-493-2	14727	648	90189-04207	21685	NI 28
86593-24000	21067	601	88970767	20869	676	8-94467-458-4	17355	348	90189-05012	14739	664
86625-3S000	22011	NI 19	88973654	20578	659	8956001	15666	682	90189-05013	13932	663
86699-2D000	21371	606	88973676	20577	677	896	B896	208	90189-05082	19187	665
867-809-966	21510	684	88974848	B194	206	8-97134-978-0	17355	348	90189-05105	20431	664
86825-28000	21378	601	88980509	20872	503	8-97214-872-0	18661	203	90189-05142	21191	665
86848-22000	21068	600	88980510	20872	503	8-97286-997-0	16897	203	90189-06001	14275	665
86848-25000	21068	600	88981030	15674	548	89785-08020	21101	562	90189-06003	14266	667
86910-21010	21232	600	88981031	15673	548	89785-60160	21101	562	90189-06005	14273	667
86910-22000	19505	666	88986451	18868	178	899	B899	208	90189-06006	14265	665
8717859	10243	348	88987187	21220	179	8E0-867-276	21252	387	90189-06010	14274	664
8731909	11620	382	88987962	17109	179	8E0-868-243	21144	403	90189-06013	14267	667
8731909	11220	365	88988301	18527	179	900	18015	201	90189-06018	14258	664
8733059	10318	472	88988609	21212	178	90001-SG0-003	14291	383	90189-06028	19194	467
8733059	11288	471	89	B89	206	90009-PH1-000	21353	224	90189-06029	19505	666
8734067	10242	347	89	16911	201	90009-PH1-000	21353	224	90189-06042	14695	587
87378-3N000	22012	NI 19	890	B890	207	90009-PY3-000	20426	225	90189-06065	20440	666

O.E.M. INTERCHANGE BY NUMERICAL ORDER

O.E.M. No.	Auveco No.	Page No.	O.E.M. No.	Auveco No.	Page No.	O.E.M. No.	Auveco No.	Page No.	O.E.M. No.	Auveco No.	Page No.
90189-06084	19505	666	90467-07041-B2	17162	487	90467-10107	19123	384	90658-SB0-003	14701	582
90189-06104	19742	609	90467-07041-C0	17162	487	90467-10123	19014	383	90658-SB0-0030	14701	582
90189-06111	19783	517	90467-07042-C0	21560	368	90467-10146	19728	382	90661-SC7-003	14695	587
90189-06114	20412	667	90467-07043	16784	677	90467-10152	19534	667	90661-SC7-0030	14695	587
90189-06116	19505	666	90467-07043-11	16784	677	90467-10161	18876	396	90661-ST7-003	18456	570
90189-06145	21625	609	90467-07043-C0	16784	677	90467-10162	18861	387	90662-671-003	14313	586
90189-06157	19721	666	90467-07044	19128	678	90467-10167	20559	393	90662-671-0030	14313	586
90189-06162	18747	656	90467-07049-C0	20874	375	90467-10168	18950	395	90662-693-003	14281	587
90189-06177	21411	667	90467-07050	14737	383	90467-10170-C0	21702	NI 30	90662-693-0031	14281	587
90189-06193	20895	664	90467-07059-22	19013	676	90467-10170-C0	21702	NI 30	90662-SB2-003	14313	586
90189-06211	21331	665	90467-07066	17383	486	90467-10173	19123	384	90664-671-003	14328	379
90189-06214	19756	666	90467-07066-J0	17383	486	90467-10183	20869	676	90664-692-0300	16861	585
90189-06236	21792	NI 28	90467-07071-22	21249	675	90467-10183	20869	676	90664-SB0-004	15472	584
90189-A0002	20440	666	90467-07076-C0	17162	487	90467-10186	21634	384	90664-SB3-003	20303	587
90189-A0002	21605	609	90467-07096	19124	386	90467-10188	20633	395	90665-SA0-9700	12576	577
90212-SAS-003	16470	65	90467-07117	18270	613	90467-10190	21537	608	90665-SM4-000	19646	587
90269-03064	21320	255	90467-07121	19908	677	90467-10206	21624	676	90666-SA0-003	14289	366
90269-04006	20787	254	90467-07121-B2	19907	677	90467-11063	17481	658	90666-SA0-0030	14289	366
90269-04047	21715	NI 5	90467-07126	19535	667	90467-11099	21550	658	90666-SA0-003A3	14289	366
90269-04050	20628	254	90467-07137	21692	NI 29	90467-11100	20429	658	90666-SA0-003A9	14289	366
90269-04051	20788	253	90467-07138	17992	613	90467-11111	19647	658	90666-SA0-003ZD	14289	366
90269-04053	20627	254	90467-07138-C0	17992	613	90467-11117	22051	NI 29	90666-SAT-003ZW	19506	367
90269-04053	20627	254	90467-07138-C0	17992	613	90467-11117	22051	NI 29	90666-SD9-000	20351	585
90269-04060	21714	NI 4	90467-07146	19552	676	90467-12071	21698	NI 27	90666-SS0-003	19740	581
90269-05034	21713	NI 5	90467-07164	20908	678	90467-12072	21848	NI 28	90667-671-013ZA	20381	384
90269-05034	21713	NI 5	90467-07166	18888	678	90467-12073	21641	659	90667-SOD-003ZC	20334	369
90269-05035	17420	250	90467-07168	20577	677	90467-12074	21697	NI 27	90667-SA0-003	16776	369
90269-05035	20626	258	90467-07168-C1	20577	677	90467-12075	21642	660	90667-SA0-0030	16776	369
90269-05054	20626	258	90467-07188	21011	676	90467-12078	16779	386	90667-SAT-003	16775	371
90269-05056	21713	NI 5	90467-07190-B2	21104	675	90467-12078-01	16779	386	90667-SAT-0030	16775	371
90269-05065	21046	257	90467-07192	21120	676	90467-12080	21549	657	90667-SAT-003ZB	16775	371
90269-06013	20834	258	90467-07201	20955	678	90467-12096	14277	664	90667-SD4-003	19464	388
90269-06017	21315	260	90467-07211	21201	614	90467-13005	17194	657	90668-688-003	14296	586
90269-A0005	21315	260	90467-07211	21201	614	90467-13011	17195	632	90668-688-0030	14296	586
90269-A0006	20788	253	90467-07214	21294	678	90467-13075	21623	657	90668-SAT-000	14296	586
90269-A0006	20788	253	90467-08004	18297	383	90467-17004	17438	657	90668-SB0-003	14698	596
90321122	21088	388	90467-08008	14737	383	90467-A0003	19113	384	90669-671-000	14284	680
90331AA050	21565	380	90467-08011	18297	383	90467-A0003	19729	384	90669-671-0000	14284	680
90331GA090	21573	382	90467-08011-83	18297	383	90467-A0005	21102	395	90669-SB0-003	19487	632
90341-10006	19318	223	90467-08014	19121	371	90467-A0005	21102	395	90669-SP0-003ZA	19744	368
90341-10011	19318	223	90467-08014-01	19121	371	90467-A0006	18876	396	90669-SP0-003ZB	19744	368
90341-10012	19318	223	90467-08045	21695	NI 29	90467-A0008	20878	371	90670-692-003	16781	384
90341-12012	21293	223	90467-08045	21695	NI 29	90467-A0008	20878	371	90670-SG0-003	19741	587
90341-12012	21293	223	90467-08063	21695	NI 29	90467-A0018	21615	681	90671-SOD-003ZK	21303	367
904	20291	202	90467-08081	18878	384	90468-04030	16671	680	90672-671-003	18157	383
90418-SW3-003	19470	368	90467-08101	21643	383	90468-04038	16306	680	90672-671-8110M1	14268	665
90430-12018	22134	NI 4	90467-08122	19122	384	90471-PX4-000	16955	222	90672-SA0-003	14298	598
90430-12019	17628	222	90467-08124	19113	384	90505-SLO-003	19140	635	90672-SA0-0030	14298	598
90430-12027	22134	NI 4	90467-08136	21254	386	90505-SM4-003	17057	596	90672-SA6-003	14700	584
90430-12028	17628	222	90467-08155	19140	635	90505-SX0-003	19453	594	90672-SA6-0030	14700	584
90430-12031	22134	NI 4	90467-08179	19910	396	90520-01002	2288	346	90673-SC6-003	14703	584
90430-C0005	22134	NI 4	90467-08180	20910	595	90520-01274	2288	346	90673-SC6-0030	14703	584
90463-10337	14284	680	90467-08180	20910	595	906	8906	206	90674-692-003	12580	582
90467-04034	21552	380	90467-08185	20349	677	906	16922	201	90674-692-0030	12580	582
90467-05020-01	19506	367	90467-08186	20184	368	90601-SH3-014	17442	580	90674-SA5-003	14293	593
90467-05045-22	19686	365	90467-08186-C0	20184	368	90601-SK7-003	18759	568	90674-SA5-0030	14293	593
90467-05063-C0	21218	675	90467-08195	21847	NI 28	90602-S2A-003	21696	NI 17	90674-SA6-003	12580	582
90467-05081	21615	681	90467-08196	21846	NI 28	90602-S2A-003	21059	397	90674-SB0-000	14268	665
90467-05090-B1	21103	675	90467-09004	19112	385	90602-S7S-003	20611	387	90674-SC6-003	15474	584
90467-05096-22	19312	367	90467-09004-01	19112	385	90602-SAA-003	21087	396	90675-692-003	14306	578
90467-05114	20956	681	90467-09006	18842	385	90602-SEP-A00	21131	398	90675-692-0031	14306	578
90467-05114	20956	681	90467-09008	14738	385	90602-SFA-004	21308	567	90675-SA5-003	22105	NI 3
90467-05125	21693	NI 29	90467-09008-01	14738	385	90602-SX0-003	21107	388	90675-SA5-003	22105	NI 3
90467-05128	21614	681	90467-09050	19729	384	90602-SX0-003	21107	388	90675-SA6-003	14294	586
90467-05136	21849	NI 30	90467-09065-B1	16781	384	90602-TA0-003	21417	572	90675-SA6-0030	14294	586
90467-05136	21849	NI 30	90467-09069-01	21821	NI 29	90602-TA0-003	21417	572	90675-SB0-003	16000	596
90467-05138	21687	NI 31	90467-09093	17439	613	90603-S7S-003	20612	586	90675-SB3-003	16000	596
90467-05138	21687	NI 31	90467-09096	19219	678	90605-SF1-003	17089	581	90676-SAT-003	17058	586
90467-05164-B6	21253	368	90467-09101	18939	613	90612-SF1-003	17320	581	90676-SR4-003	18115	588
90467-05164-E2	21332	368	90467-09127	19739	678	90621-SK7-003	18756	568	90677-671-003	14687	597
90467-05170	22125	NI 30	90467-09138	17990	384	90651-SL9-013	19454	588	90677-693-003	14687	597
90467-05170	22125	NI 30	90467-09139	19416	677	90651-SL9-0130	19454	588	90677-SE0-003	16950	597
90467-06017	14260	676	90467-09143	17988	613	90651-TP8-003	21705	NI 17	90679-692-003	14308	578
90467-06017-41	14260	676	90467-09145	17206	676	90651-TP8-003	21705	NI 17	90679-692-0030	14308	578
90467-06017-C0	14260	676	90467-09166	21010	678	90652-SB2-023	16949	597	90681-693-000	14280	586
90467-06092	17991	382	90467-09185	21547	677	90653-HC4-900	17222	488	90682-SB0-003	17058	586
90467-06128	21626	383	90467-09204	21546	657	90654-SA4-003	19730	597	90682-SDA-A01	21205	587
90467-06133-C0	20196	675	90467-09206	20437	395	90655-SA0-003	14288	585	90682-SEA-003	20954	587
90467-06138	19720	382	90467-09212	21410	392	90655-SA0-0030	14288	585	90682-SEA-003	20954	587
90467-06150	19490	676	90467-09227	21366	678	90656-671-6310M1	14287	586	90683-693-000	14690	586
90467-06161-01	14736	383	90467-10018	14347	386	90657-SA6-003	14697	595	90683-693-0000	14690	586
90467-06175	21560	368	90467-10077	19797	658	90657-SA6-0030	14697	595	90683-SA5-003	19311	596
90467-07041	17162	487	90467-10096	19534	667	90657-SB0-003	19186	593	90683-SA6-003	14685	582

O.E.M. INTERCHANGE BY NUMERICAL ORDER

O.E.M. No.	Auveco No.	Page No.	O.E.M. No.	Auveco No.	Page No.	O.E.M. No.	Auveco No.	Page No.	O.E.M. No.	Auveco No.	Page No.
90683-SA6-0030	14685	582	912	18008	201	91516-SM4-013	19116	381	91578-T0A-003	21836	NI 17
90683-SC6-003	14685	582	9132667	22088	NI 4	91517-SE0-003	19247	467	91589-SV4-003	20272	580
90683-SC6-0030	14685	582	9133073	20407	690	91518-S10-003	19682	385	91591-SJ6-013	21170	574
90684-SA5-003	14696	595	9133417	21859	NI 22	91518-SM4-003	19114	385	91591-SJ6-013	21170	574
90685-SA5-003	14356	386	9133417-7	19904	690	91519-S5A-003	20387	583	916	8916	206
90687-671-003	14319	386	9145	BH10	209	91519-SCV-A01	21597	580	916	18006	201
90687-671-003	14319	386	91486KJ000	21590	652	91520-S5A-003	20386	583	91601-STX-A00	21209	571
90687-671-0030	14319	386	91486KJ010	21531	652	91520-SM4-C01	18114	385	91603-SL0-003	21635	586
90687-SA5-003	14282	383	91500-SM4-999AH	16960	36	91520-SR3-003	17475	584	91604-SD2-013	18454	597
90687-SA5-0030	14282	383	91501-S04-003	19118	594	91524-SE0-003	17081	596	91619-SA5-000	14274	664
90687-SB0-003	17287	595	91501-S1K-003	20609	378	91526-SP1-003	18767	569	91619-SM4-003	19117	586
90687-SB0-013	17287	595	91501-SEA-003	20882	384	91527-SM4-003	19415	580	91619-SM4-0030	19117	586
90687-SB2-901ZF	17287	595	91501-SG0-003	17440	567	91527-SP1-003	18757	568	91620-SR2-003	19307	587
90688-SB0-003	14968	498	91501-SL4-003	19467	383	91527-SZ3-003	19415	580	91623-SM2-003	19143	588
90688-SB0-013	14698	596	91501-SM4-003	17205	385	91528-S01-A01	19115	585	91623-SM2-0030	19143	588
90688-SB0-013	14698	498	91501-SM5-A00	19680	581	91528-SP1-003	18758	569	91626-SH3-003	19741	587
90692-SA5-0030	14290	593	91501-SNA-003	22054	NI 17	91528-SR4-003	19115	585	91626-SPO-003	21700	NI 16
90694-SB0-003	17281	584	91501-SP1-003	19225	567	91528-SS0-003	18866	582	91635-SM4-003	17609	586
90694-SB0-0030	17281	584	91501-SK7-003	20609	378	91529-SS0-003	18865	582	91641-SH3-013	19679	587
906A	B906A	206	91501-SWA-003	21652	378	91530-S0A-003	21773	NI 17	91651-SZ3-003	19463	571
90700-SB2-003	15998	376	91501-TRO-003	21651	594	91530-S0A-003	21773	NI 17	91652-SPO-003	19465	570
90700-SJ4-000	18746	378	91502-S84-A11	19683	381	91530-SE0-003	14328	379	91652-SZ3-003	19746	365
90713-SB0-003	14705	584	91502-S9A-003	21216	580	91530-SP1-003	18877	381	916581	9884	183
90814FC001	21322	653	91502-SM4-000	17143	597	91530-SS0-003	18864	582	916581	9885	183
90866-SAO-000	20350	585	91502-SM4-000	19407	597	91530-ST5-003	19116	381	916632	9916	183
90901-89004	20660	610	91502-SPO-003	18119	597	91531-ST0-003	19359	580	916638	9884	183
90904-67021	19430	657	91502-SZ5-003	19232	573	91533-ST0-003	19668	568	916638	9885	183
90904-67036	20390	658	91503-S0K-A01	20608	594	91534-SE0-000	17443	578	916A	B916A	206
90904-67037	20391	658	91503-S3Y-003	21419	579	91534-SE0-003	17443	578	916NA	18007	201
909130003	21585	654	91503-S7A-003	21297	594	91534-SM4-003	17282	584	917	20293	202
909130007	21567	388	91503-SHJ-A01	21454	595	91535-SPO-003	18754	569	917	20293	202
909130008	21771	NI 26	91503-SK7-013	19723	571	91537-SPO-013	18236	570	917	20293	202
909130013	21658	634	91503-SPO-003	17267	573	91541-SM4-003	19670	583	917	20293	202
909130034	21574	393	91503-SZ3-003	19233	573	91542-SPO-003	19670	583	917	20293	202
909130051	21594	655	91503-SZ3-003	19233	573	91545-SE0-003	16782	595	917	20293	202
909130059	21563	655	91503-SZ5-003	20564	595	91545-SE0-003-W1	16782	595	917	20293	202
909130067	21530	654	91503-SZ5-003	20564	595	91547-SE0-003	14688	597	917	20293	202
909130074	21421	376	91503-T2A-A01	21796	NI 16	91547-SE0-0030	14688	597	917	20293	202
909130109	21591	388	91504-SM4-000	17144	596	91550-S50-000ZK	21477	595	917	20293	202
909130213	21502	396	91504-SM4-000	19408	596	91550-S50-000ZL	21190	595	917	20293	202
909140002	21576	444	91504-SP1-003	21558	579	91550-SH3-003	19142	596	917	20293	202
909140007	21420	655	91504-SP1-003	21558	579	91550-SH3-003ZR	19142	596	917	20293	202
909140012	21570	654	91504-SR3-003	20432	597	91558-SE3-003	21388	574	917	20293	202
909140051	21422	654	91505-S9A-003	20986	594	91558-SE3-003	21388	574	917	20293	202
909140052	21592	654	91505-SG0-003	17280	584	91560-S0X-A01	21638	393	917	20293	202
909140054	19233	573	91505-SL0-003	19231	573	91560-S6A-003	21206	394	917	20293	202
909140055	21501	655	91505-S77-003ZA	20910	595	91560-S7A-003	21554	394	917	20293	202
909140062	22160	NI 26	91505-TM8-003	21706	NI 17	91560-S84-A01	21149	393	917	20293	202
909140063	21500	655	91505-TM8-003	21706	NI 17	91560-S84-A11	20411	591	917	20293	202
909300007	22044	NI 26	91506-S9A-003	21173	573	91560-S9A-A01	20959	394	917	20293	202
909300015	21569	652	91506-S9A-003	21173	573	91560-S9A-A01	20959	394	917	20293	202
90950-01248	16777	385	91507-SH3-003	17632	523	91560-SL4-003	20610	397	917	20293	202
90950-01620	22097	NI 31	91508-S50-003	19547	593	91560-SLJ-J01	21208	393	917	20293	202
90950-01620	22097	NI 31	91508-SM4-003	17192	594	91560-SLJ-J01	21208	393	917	20293	202
90950-08004	22159	NI 29	91508-SR3-000	18165	594	91560-SM4-003	20610	397	917	20293	202
90959-01136	17631	679	91510-SR3-003	17981	580	91560-SPO-003	19145	394	917	20293	202
90981-13018	20600	204	91511-SR2-004	19223	582	91560-SZ3-003	19466	393	917	20293	202
9098113046	B9005	208	91512-S50-003	21555	579	91560-SZW-003	21675	393	917	20293	202
90981-13046	16897	203	91512-S50-003	21555	579	91560-SZW-J01	21676	394	917	20293	202
9098113047	B9006	208	91512-SE0-003	18512	597	91561-S84-A00-M1	20352	596	917	20293	202
90981-13055	18661	203	91512-SJ6-J01	21559	578	91561-S84-A01	19415	580	917	20293	202
90981-13055	20601	204	91512-SJ6-J01	21559	578	91561-SJD-003	21141	592	917	20293	202
9098113075	BH11	209	91512-SJK-003	22069	NI 17	91561-SW5-003	19479	570	917	20293	202
90982-08188	15926	171	91512-SJK-003	22069	NI 17	91562-S84-A01	20737	580	917	20293	202
90982-08189	15927	171	91512-SM4-003	17379	596	91562-SV4-003	18405	581	917	20293	202
90982-08202	15930	171	91512-SPO-003	18762	570	91563-SCV-003	21707	NI 17	917	20293	202
90982-08203	15931	171	91512-SP1-000	18762	570	91563-SCV-003	21707	NI 17	917	20293	202
90982-08223	15929	171	91512-SR3-004	20472	588	91566-SPO-003	18294	398	917	20293	202
90982-09019	21602	172	91512-STK-A01	22112	NI 17	91567-S3M-000	21458	365	917	20293	202
90982-09025	21604	172	91512-STK-A01	22112	NI 17	91567-SR2-013	21548	365	917	20293	202
91017FA080	21562	651	91512-SX0-003	19239	594	91568-SL4-003	17608	570	917	20293	202
91059FC030	21581	651	91512-SX0-003	19239	594	91568-SR2-003	19171	381	917	20293	202
91059FC041	22050	NI 26	91513-SE0-003	18818	382	91568-TRO-003	21705	NI 17	917	20293	202
91059FC090	21572	651	91513-SJK-003	22068	NI 17	91568-TRO-003	21705	NI 17	917	20293	202
91059FC110	21564	651	91513-SJK-003	22068	NI 17	91570-SDA-A01	21095	582	917	20293	202
91084AA010	22043	NI 26	91513-SM4-000	17096	581	91570-SK7-003ZF	19546	596	917	20293	202
91085TA030	21566	654	91513-SMG-E11	21207	578	91570-SZA-305	21543	583	917	20293	202
91167AA000	21579	652	91513-SPO-003	17323	568	91571-SDA-A01	21096	583	917	20293	202
91167FA010	22046	NI 26	91514-SPO-003	18764	568	91572-SDA-A01	21094	583	917	20293	202
91171148	18661	203	91514-SP1-003	18760	569	91572-SV4-003	18404	584	917	20293	202
91171148	20601	204	91515-SR3-000	19483	382	91574-SV4-003	18406	581	917	20293	202
91173701	15926	171	91515-SR4-003	19737	580	91576-SV4-003	19477	581	917	20293	202
91176726	20417	478	9151649	20405	689	91577-SV4-003	19476	569	917	20293	202
912	B912	206	91516-SK7-013	17350	596	91578-SV4-003	18457	577	917	20293	202

O.E.M. INTERCHANGE BY NUMERICAL ORDER

O.E.M. No.	Auveco No.	Page No.	O.E.M. No.	Auveco No.	Page No.	O.E.M. No.	Auveco No.	Page No.	O.E.M. No.	Auveco No.	Page No.
9421330	16902	201	9437173	20710	210	9442879	20683	203	97		206
9421330	B194	206	9437173	B912	206	9442880	B889	207	97	16912	201
9421777	16912	201	9437486	12655	252	9442881	20599	204	9711304	15759	503
9421777	B97	206	9437643	20402	252	94467458	17355	348	97134978	17355	348
94218027	17195	632	9437846	14486	252	94515340	16136	64	9716926	14549	509
94221150	14727	648	9437938	11621	252	94530385	21299	476	9721917	14550	509
9422202	13708	27	9437938	16838	252	94530438	21112	485	972724	4244	339
9422246	13707	26	9438068	18012	201	94530565	21070	393	9731301	11152	348
9422339	18469	201	9438068	B194A	206	94530742	21316	476	97606-B0700	13930	639
9422552	11292	102	9438150	11246	462	946-418	13220	69	9786454	9354	19
94226492	14269	395	9438848	16907	201	947-098	13230	628	9786454	9355	19
9423101	19777	35	9438848	B2057	206	94841226	14750	680	9786454	9356	19
9423950	15827	30	9438850	16908	201	94842841	18297	383	9795883	10068	19
9424837	9880	104	9439559	18749	258	94847334	17383	486	9796223	10714	32
9425491	9881	104	9439719	12657	259	94848189	18330	382	979878-6	19376	256
9425542	16921	201	9440178	9879	104	94848192	18330	382	980557	83357	206
9425542	20706	210	9441592	18167	252	94848834	15695	657	9808241	10630	348
9425542	B168	206	94415FA000NE	22047	NI 26	94849113	18297	383	9815325	14967	548
9426331	12547	172	9441723	B890	207	94852368	19140	635	9818648	10621	401
9426334	12545	172	9441724	20598	204	94854203	19194	467	9822198	14548	509
9427587	18013	201	9441724	B891	207	94858299	18876	396	9838109	10318	472
9427761	10666	102	9441725	12083	249	94858338	19312	367	9838109	11288	471
9427882	9282	232	9441728	B880	207	94858343	19726	484	9854717	10631	348
9427909	8925	240	9441731	16896	203	94858560	18873	677	9883583	10621	401
9427943	20289	202	9441732	16897	203	94858864	19645	484	9883583	11774	401
9427977	13709	30	9441732	B9005	208	95005064	14144	396	9883583	16260	401
9428273	13027	30	9441733	16898	203	95008221	19129	398	9895598	10701	348
9428481	3796	102	9441770	8938	240	95022AC04OML	21630	368	99045AE03AMA	21589	367
9428902	16899	201	9441837	18017	201	95188	15011	86	9924-90-512B	14367	365
9428902	B1157	206	9441837	B24	206	95230842	21529	490	9926-40-531B	18271	384
9428904	16901	201	9441838	18000	201	95900-04036	17224	663	9926-40-543A	14349	383
9428904	B1157A	206	9441838	20721	210	9590477	12675	85	9926-50-625	14260	676
9431530	9880	104	9441838	B2357A	206	9591699	12695	85	9926-50-635	14369	434
9431647	2293	103	9441839	16915	201	9591855	19168	85	9927-40-821	14363	400
9431808	16913	201	9441839	20722	210	9601750	20562	502	9927-40-822	16778	400
9431809	18011	201	9441839	B3057	206	96057846	17162	487	9927-40-825	14269	395
9432137	16687	255	9441840	16916	201	96057847	17383	486	9927-70-901	14378	624
9432552	16686	255	9441840	B3057A	206	96061699	14367	365	9927-70-904	14365	624
9433040	18010	201	9441854	17998	201	96061863	17356	499	9927-80-405	14359	624
9433043	11628	109	9441866	17999	201	96064506	19128	678	9928-90-753	14376	624
9433143	20286	202	9441866	20720	210	9617200	11118	482	9928-91-053	14298	598
94331546	20582	104	9441866	B2357	206	9624520	11066	347	9956-41-400	19621	222
9433155	9879	104	9441923	18018	201	96585564	21167	558	99604-H1400	16780	679
9433156	20582	104	9441923	20702	210	9662548	17233	483	9991-00-402	14366	618
9433184	18016	201	9441923	B24A	206	9662950	11067	347	9991-00-403	14364	618
9433186	18168	258	9441941	2808	3	9669486	11855	466	9991-00-412	13930	639
9433373	10171	1	9441956	18005	201	96706-89901	14366	618	9991-00-501	14357	618
9433489	11614	18	9442003	17996	201	96706-B0700	13930	639	9991-00-503	14313	586
9433489	11615	18	9442004	B3156	206	96706-B6700	13930	639	9991-00-601	14274	664
9434229	18732	240	9442081	17997	201	96706-H2500	14724	640	9L32-14030A12-A	20836	345
9436175	11620	251	9442361	17641	258	96706-H9400	14335	640	9N7Z-13N021-A	16897	203
9436175	16837	251	9442486	18001	201	96706-K1300	14335	640	9N7Z-13N021-A	16898	203
9436750	16922	201	9442486	B3157A	206	96706-K1351	14335	640	9N7Z-13N021-A	B9005	208
9436789	18465	201	9442492	18478	201	96706-N8000	14334	639	9XG0-73-88X0	20936	521
9436790	20284	202	9442877	B881	207	96706-P0105	14274	664			
9437173	18008	201	9442878	20596	204	9685057	11678	401			

Specifications and application information have been researched using reliable sources to obtain the most accurate listings; however, Auveco does not make or imply any warranty concerning the accuracy of the information. Auveco does not accept responsibility for errors, omissions or changes or for harm resulting therefrom. All information contained in this catalog supersedes all information in previous catalogs.

LIMITED WARRANTY. Auveco warrants that the goods sold by Auveco will, on the date of shipment, be free from defects in material and workmanship under normal use and service. THIS WARRANTY IS IN LIEU OF ALL OTHER WARRANTIES, WRITTEN OR ORAL, STATUTORY, EXPRESS OR IMPLIED, INCLUDING ANY WARRANTY OF MERCHANTABILITY OR FITNESS FOR A PARTICULAR PURPOSE.

LIMITATION OF REMEDIES AND LIABILITIES. Buyer agrees that Auveco's liability and Buyer's sole and exclusive remedy pursuant to any claim of any kind, including but not limited to a claim in contract, negligence or strict liability, against Auveco shall be (a) the repair or replacement, at Auveco's option, of defective goods, or (b) a refund of the price allowable to the defective goods if Auveco is unable to effectively repair, replace or correct the defect in a reasonable time after using Auveco's best efforts. UNDER NO CIRCUMSTANCES SHALL AUVECO HAVE ANY LIABILITY WHATSOEVER FOR SPECIAL, INCIDENTAL, CONSEQUENTIAL OR EXEMPLARY DAMAGES INCLUDING, BUT NOT LIMITED TO, LOSS OF PROFITS, COST OF ANY SUBSTITUTE FOR THE GOODS, CLAIMS OF THIRD PARTIES, OR INJURY TO PERSON OR PROPERTY.

FasTrack Web™ Cost Recovery System



Auveco's FasTrack Web, is a user-friendly software application, developed to assist collision repair shops in recovering the cost of trim clips, moulding clips and other fasteners used in automotive body repair.

Historically, the cost of fasteners used in collision repair has been an expense item that was not recovered by the body repair shop. Insurance companies usually refused to pay claims for these items without them being itemized into an invoice referencing the vehicle's repair order.

Technicians will rarely take time away from actual repair to prepare a detailed invoice. They don't view it as their job. As a result, these items are usually not invoiced and ultimately cost the collision repair shop hundreds of dollars each month in lost revenue.

With the help of FasTrack Web, these profit-draining parts now become a source of additional income for the collision repair shop.

The major benefit of FasTrack Web is its **ability to quickly and easily create the professional, accurate and detailed invoices** required by the insurance companies for reimbursement.

FasTrack Web works with a **database containing the complete line of the Auveco collision repair fasteners.** The FasTrack Web database includes detailed information on every item, including O.E.M. part numbers and current O.E.M. dealer list pricing. **FasTrack is the only software application of this type to use the actual dealer O.E.M. list pricing for the invoicing process.** This leads to unquestioned acceptance and payment by the insurance companies for the charges. The data is updated thru the year as Auveco adds new items or as the O.E.M. pricing changes.

The FasTrack Web application also offers extensive inventory control capabilities, an **iPHONE** or **Android** Scanning application or an (optional) USB bar-code scanning unit. **AUVECO'S FASTRACK WEB IS OFFERED ONLY THROUGH AUTHORIZED AUTO VEHICLE PARTS COMPANY DISTRIBUTORS.** For a Distributor in your area, call Customer Service at 1-800-354-9816 ext. 1.

Free 2 month Test Drive at www.auveco.com

FasTrack Web is simple and easy-to-use. **The application runs on any computer with internet access and a browser** such as Internet Explorer or Firefox. Once you obtain a login from Auveco, you're in business. There are **no annual updates to install since the data resides on our fast Internet server and is always up-to-date** with the latest parts and O.E.M. price information.

The FasTrack Web system will allow you to **quickly create professional invoice documents to enable recovery of the cost of body repair fasteners from the Insurance companies.** Because FasTrack Web is built around O.E.M. Dealer Price data and bills out at the manufacturer specific O.E.M. price thus providing a standardized cost basis you can count on acceptance and payment from the Insurance companies.

The reporting features of FasTrack Web allow the distributor to **gather usage information on what is moving at the shop level** for his supported shops. In addition, body shops have the **ability to add unique items** such as seam sealers, glue, tape, etc. to their personal account.

Should you want to **utilize a scanner** with FasTrack Web, take advantage of our **FREE App** on both the **IOS & ANDROID OS** (Free with subscription). We also offer a USB cable-type solution.

Still undecided? We have also included **labeling functions, various reports** such as tech usage & profit and loss, **kit building feature** and we have **video instructions** for the entire program!



For more information about FasTrack Web please visit our web site at www.auveco.com or call **Technical Support at 1-800-354-9816 x103**

AUVECO GREEN CATALOG

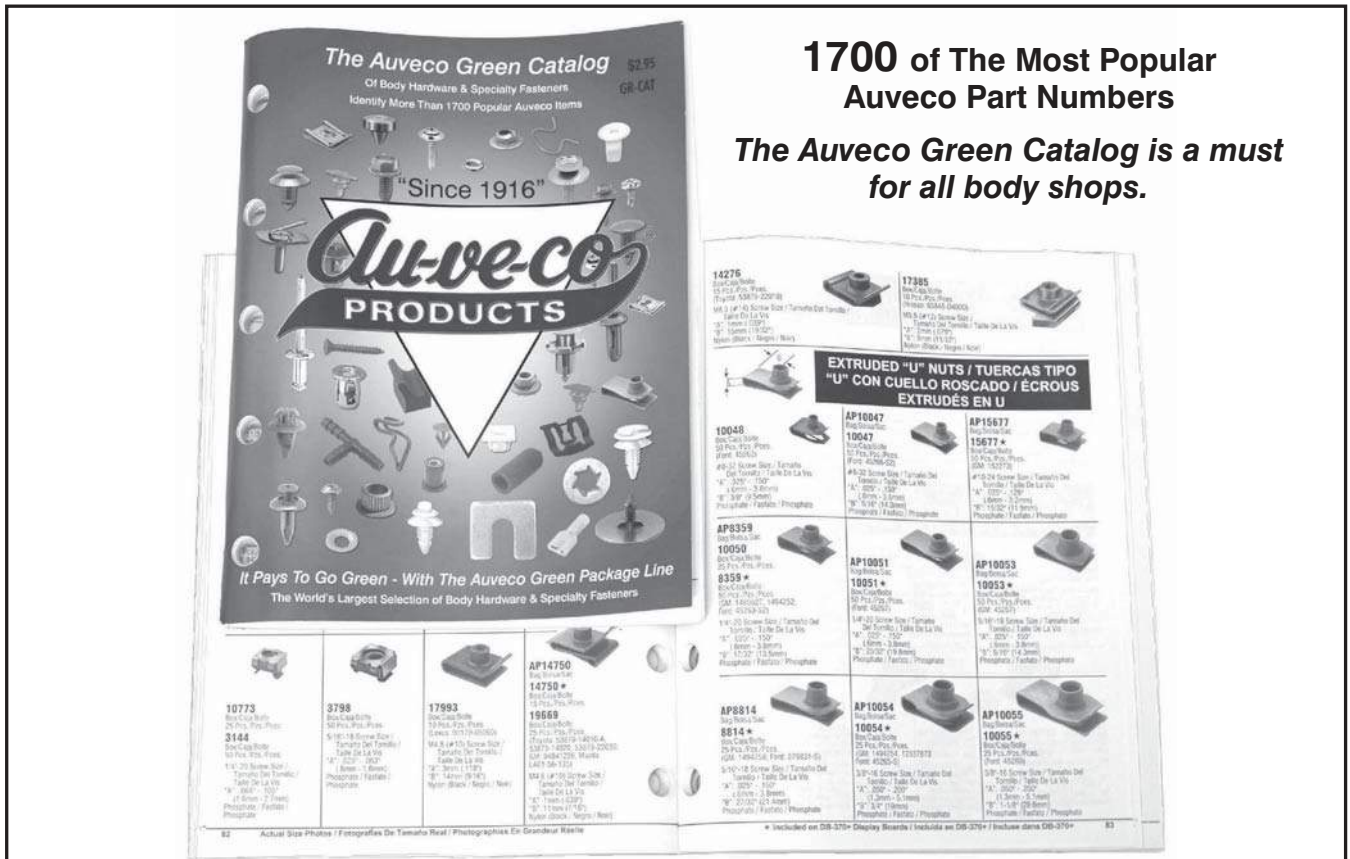

1700 of The Most Popular Auveco Part Numbers

The Auveco Green Catalog is a must for all body shops.

The Auveco Master Catalog that you are using is considered **THE ENCYCLOPEDIA OF THE AUTOMOTIVE BODY HARDWARE INDUSTRY** but a catalog of this magnitude can be overwhelming. So we've trimmed down our massive product line of over 20,000 items and produced the **extremely handy (Mini) AUVECO GREEN CATALOG**.

The **AUVECO GREEN CATALOG (part number GR-CAT)** contains over **1,700 of the most popular Auveco part numbers** divided by product group into 45 different sections. The clean, concise format makes it quick and easy to find the right part.

The AUVECO GREEN CATALOG features **trilingual verbiage** (English, Spanish and French-Canadian) and includes not only **actual size pictures** of all the products but **O.E.M. numbers**, pertinent specifications, dimensions, colors, plating information, etc. as well. The **AUVECO GREEN CATALOG takes the guess work out of identifying Body Hardware and Specialty Fasteners**. Determining the correct Auveco part numbers and unit package quantities has been made easy.

Items included on the Auveco Display Boards are identified in the AUVECO GREEN CATALOG with a ★ symbol. The Auveco display boards contain those items that we recommend as stocking items for all of our distributors.

The AUVECO GREEN CATALOG includes the **"AP" AuvecoPak part numbers** for those customers that have the **AuvecoPak Retail Merchandiser**.

HELPFUL HINTS

FOR USING THE AUVECO CATALOG

We have tried to make this catalog as easy as possible to use while still providing you with all the necessary information required to identify the part that you need. The features listed below should help you to quickly find the proper section of the catalog and determine the correct Auveco part number.

1. **The color-coded pages** signify various sections which are as follows:

- YELLOW - **New Items** (The latest items added to the Auveco product offering)
- BLUE - **Metric Items** (Cap Screws, Machine Screws, Body Bolts, Tapping Screws, Hex Nuts, Free Spinning Washer Nuts, Pushnut Bolt Retainers, "U" & "J" Nuts, Washers, Retaining Rings, Grease Fittings and miscellaneous items).
- BEIGE - **Electrical Accessories** (Solderless Terminals & Connectors, Wire & Loom, Battery Terminals, Heat Shrink Tubing, Fuses, Pigtails & Sockets, Miniature Bulbs, Switches, etc.)
- GREEN - **Assortments, Cabinets, Bins & Racks** (AuvecoPaks, Body Hardware Master Assortments, Small Drawer & Large Drawer "Fix-Kits", Quik-Select, Quik-Select II and "FP" 4 Pack Assortments)
- GRAY - **Key Blanks & Accessories** (Key Blanks, Tumblers, Springs & Lock Cylinders)
- PINK - **Import Car Body Hardware** (Non-threaded fasteners cataloged by import manufacturers from Acura to Volvo.)

2. We have **three different types of indexes** in the front of the book to assist you.

Pictorial QUICK INDEX - the pictures tell you at a glance which pages to turn to.

The section numbers correspond to the section numbers printed in the upper outside corner of each page. You can also easily see the sequence of the catalog - threaded fasteners, common non-threaded fasteners, electrical accessories, brass and grease fittings, rivets, kits, rubber products, glass shop supplies, motors and horns, trimming sundries and fasteners, domestic application body hardware, key blanks, import application body hardware, miscellaneous products and tools.

ALPHABETICAL INDEX is helpful when checking to see if we carry a specific product line. Popular categories are in bold type.

NUMERICAL INDEX for when you have the Auveco part number and need to know which page it is on.

3. Wherever practical, we have shown the **parts as actual size**. Unless the picture: is labeled "Not Actual Size", is a typical picture accompanying a chart or is obviously not actual size, you should be able to set a part on top of the picture to positively identify it.

4. We have included **Specification Charts** to assist you in the identification of various types of fasteners. The charts can be found on the following pages: **Body Bolts** (pages 20 & 49-50), **Special Tapping Screws** (pages 23-26 & 54-57), **License Plate Screws** (pages 33 - 34), **"Xmas Tree" Retainers** (pages 404-413) and **Push-Type Retainers** (Pages 450-460). The charts list the pertinent dimensions, plating and color information and the page number on which the actual size picture and application information is shown for each item.

5. At the back of the catalog are two **O.E.M. Part Number to Auveco Part Number Cross References**. One of these interchanges is broken down by O.E. manufacturer i.e., General Motors, Ford, etc. The other interchange combines all O.E.M. numbers together and is sequenced strictly in alpha-numeric order regardless of the manufacturer.

QUICK INDEX

Tapping Screws & Wood Screws **Sec. 1** 1-8



Cap Screws, Carriage Bolts, Frame Bolts, Machine Screws, Set Screws, Stainless Steel Fasteners & Stove Bolts **Sec. 2** 9-16



Body Bolts, Bumper Bolts & Special Carriage Bolts **Sec. 3** 17-22



Special Tapping Screws **Sec. 4** 23-32



License Plate Fasteners **Sec. 5** 33-39



Cylinder Head And Manifold Studs & Threaded Rod **Sec. 6** 40-41



Metric Items **Sec. 7** 42-77



Nuts: Standards And Specials & Wheel Studs And Nuts **Sec. 8** 78-87



QUICK INDEX

Helical Thread Repair Inserts **Sec. 9** 88-109
 Nuts: Extruded "U", Flat, "J", Tubular
 And "U", Nutserts®, Teenuts®, Threaded Inserts
 & Well Nuts®



Clevis Pins, Cotter Pins, **Sec. 10** 110-130
 Plug Buttons, Retaining Rings,
 Shims, Spring Pins, Springs, Straight Keys,
 Washers, Woodruff Keys & Yoke Ends



Connectors, Air Line Couplings,
 Rubber Caps, Hose & Tubing **Sec. 11** 131-138



Cable Ties, Electrical Accessories **Sec. 12** 139-221
 & Wire Loom Clips



Brass Fittings,
 Grease Fittings And Accessories **Sec. 13** 222-238
 & Oil Drain Plugs And Gaskets



Drill Bits & Rivets **Sec. 14** 239-262



QUICK INDEX

Assortments, AuvecoPaks, **Sec. 15** 263-328
Cabinets, Drawers & Special Racks



Glass Setting Channel, **Sec. 16** 329-344
Grommets, Hold Down Straps, "O" Rings, Rubber Bumpers & Caps, Tire Valves, Weatherstrip & Windshield Filler Strip



Glass Shop Supplies **Sec. 17** 346-353



Horns, O.E.M. Air Conditioning, **Sec. 18** 354-356
Heater Fan And Radiator Fan Motors, O.E.M. Power Window Lift Motor & Gears



Canvas And Curtain Fasteners, **Sec. 19** 357-461
Push-Type Retainers, Snap Fasteners, Trimming Sundries And Fasteners & Truck Seat Springs



QUICK INDEX

AMC, Chrysler, Ford & GM
Clips And Fasteners

Sec. 20

462-551

Import Car Clips
And Fasteners

Sec. 22

567-690



Key Blanks, Locks,
Lock Hardware & Accessories

Sec. 21

552-566

Universal Moulding Fasteners

Sec. 23

691-693



QUICK INDEX

Ball Joint Assemblies

Sec. 24

694-699



Hose Clamps & Tubing Clamps

Sec. 25

700-705



Auveco Body Sealer, Seam Sealer, Seam-N-Joint Sealer, Auveco Flex, Rigid Set, Fikit Quik Epoxy Putty & Manifold Repair Kit

Sec. 26

706-709



Miscellaneous Items

Sec. 27

710-722



Boxes, Tools & Lubrication Items

Sec. 28

723-737



A	
Acorn Nuts.....	16, 65, 83
Acura Clips & Fasteners	567-574
Adhesive Weatherstrip.....	334-335
Aerosol Can Caddy.....	283
Air Conditioning Fan Motors.....	354
Air Conditioning "O" Rings	331-332
Air Hose.....	137
Air Line Couplings & Accessories.....	136
Alignment Shims.....	115-116
Anchor Shackles.....	716
Anchors & Toggle Bolts.....	715-716
Anti-Corrosion Protectant.....	167
Apparel.....	769
Assortments (Green Pages).....	270-328
Audi Clips & Fasteners	682-689
Auto Bulbs.....	201-212
Auveco Body Sealer (1001 & 1002)	707
Auveco "Fix-Kits".....	290-308
Auveco Flex & Rigid Sealer.....	708
AuvecoPak.....	263-269
Avex® Blind Rivets.....	247
B	
Ball Joint Assemblies	694-699
Barrel Nuts	67, 100
Barrel Pumps.....	737
Battery Bolts.....	166
Battery Cable.....	164
Battery Hold Down Bolts.....	722
Battery Terminal Bolts.....	166
Battery Terminals.....	164-166
Battery Tools.....	167
Belt Weatherstrips.....	342
Bin Bases.....	283, 298
Bin Labels.....	284, 714
Bins.....	282-283
Bits:	
Drill.....	262
Torx® (Drivers & Inserts).....	2, 58, 728
Blades, Razor.....	725
Blanket, Welding.....	710
Blind Rivets	239-240, 244-261
Blow Gun.....	136
BMW Clips & Fasteners	574-577
Body Bolts:	
Metric.....	48-54
U.S.....	20-22
Body Hardware Master Asst	270-276
Body Sealer (1001 & 1002)	707
Body Shop Bin Assortments.....	285
Bolt Extractor Kit.....	730
Bolt Retainers:	
Metric.....	66
U.S.....	82
Bolt Snaps.....	716
Bolts:	
Battery.....	166
Battery Hold Down.....	722
Body:	
Metric.....	48-54
U.S.....	20-22
Bumper.....	17-19, 62
Carriage.....	10
Frame (Hex Flange).....	11
Grade 5.....	12
Grade 8.....	13
Hex Flange Frame.....	11
Hex Flange Serrated (Metric).....	48
Hex Head Sems Split	
Wave Washer (Metric).....	47
License Plate.....	33-38
Spak.....	47
Spin Lock.....	8
Stainless Steel.....	15
Starter.....	22
Stove.....	9
Boxes, Plain White.....	729
Brackets, Rear View Mirror.....	352
Brass Fittings	233-238
Brass Grommets	360
Brass Nuts.....	78, 81
Brushes (Acid, Chip, Dope & Scratch).....	714
Bulbs, Light.....	201-212, 713
Bulbs, Miniature.....	201-212
Bumper Bolts.....	17-19, 62
Bumpers, Rubber.....	338-340
Buttons:	
Plug.....	129
Trim.....	357-358
Bushings:	
All-Fit Adjustable.....	717
Door Hinge.....	509-510, 533, 549
Nylon Spacer (Stand-Offs).....	717
Standard Insulating.....	717
C	
Cabinets & Accessories	277-284, 298
Cable, Battery.....	164
Cable, Tailgate.....	503
Cable Tie Mounts.....	221
Cable Tie Tool.....	221
Cable Ties.....	218-221
Cage Nuts.....	67, 81, 105
Can Caddy.....	283
Canvas & Curtain Fasteners	
("Dot" Brass).....	363-364
Cap Screws:	
Metric.....	43-46
Socket Head, Metric.....	46
Stainless Steel.....	15
U.S. (Gr. 5 & Gr.8).....	12-13, 15
Caps, Rubber & Vinyl Vacuum	131, 341
Carriage Bolts.....	10
Caulking Guns.....	736
"Christmas Tree" Retainers	365-413
Chrysler Clips & Fasteners	535-550
Circuit Breakers.....	172
Circuit Tester.....	161
Clevis Ends.....	128, 700
Clevis Pins.....	127
Clamps:	
Hose.....	700-703
Tubing.....	216, 704-705
Clip Removal Tool.....	723-724
Clips:	
Acura.....	567-574
AMC.....	551
Audi.....	682-689
BMW.....	574-577
Chrysler.....	535-550
Fiat.....	577
Ford.....	511-534
General Motors.....	462-510
Honda.....	577-598
Hyundai.....	598-601
Infiniti.....	601-604
Isuzu.....	604-605
Kia.....	605-607
Land Rover.....	607
Lexus.....	607-615
Mazda.....	615-625
Mercedes-Benz.....	625-630
Mini-Cooper.....	631
Mitsubishi.....	631-636
Nissan.....	637-649
Opel.....	650
Renault.....	650-651
Saab.....	651
Subaru.....	652-655
Suzuki.....	656
Toyota.....	656-681
Volkswagen.....	682-689
Volvo.....	689-690
Universal.....	690-693
Window Reveal Moulding.....	347-349
Wire Loom.....	215-217, 496-497
Closed-End Connectors & Terminals.....	147
Co-ax Cable Clips.....	216
Compression Battery Terminals.....	165
Compression Springs.....	125
Connectors:	
Air Line.....	136
Electrical.....	139-157, 160, 174-200
Nylon Vacuum.....	131-134
Polyethylene.....	135
Rubber.....	135
Trailer.....	199-200
Twist-Type Wire.....	160

Copper Washers:	
Metric.....	71
U.S.....	112
Cord, Sponge Rubber.....	337
Cotter Pins:	
Metric.....	74
Stainless Steel.....	15
U.S.....	127
Covers & Bases, Screw.....	2, 361
Crimping Tools (Electrical).....	158-159
Curtain Fasteners.....	363-364
Cutoff Wheels & Mandrels.....	733
Cylinder Head Studs:	
Metric.....	41, 62
U.S.....	40
D	
Damper Control (Arm).....	696
Dampening Pads (Trunk/ Vibration/Sound).....	712
Display Boards.....	Color Pages
Door Handle Clips.....	346-347
Door Hinge Bushings	509-510, 533, 549
Door Hinge Pin & Bushing	
Repair Kit.....	504-507, 550
Door Hinge Pins	507-509, 533, 550
Door Lock Striker Bolt	
Assemblies.....	502, 532-533
Door Locks.....	563-565
Door Seals.....	342
"Dot" Curtain Fasteners.....	363-364
Double End Threaded Studs:	
Metric.....	41, 62
U.S.....	40
Drain Cocks & Valves.....	237
Drain Plugs & Gaskets.....	222-227
Drill Bits.....	262
Drill-Out® Bolt Extractor Kit.....	730
E	
"E" Type Retaining Rings.....	72, 119, 122-123
Electrical Connectors.....	139-157, 160, 174-200
Electrical Pigtails & Sockets.....	174-200
Electrical Section-Brown Pages	139-214
Electrical Tape.....	167
Electrical Terminals.....	139-157
Electrical Crimping Tools.....	158-159
Electronic Fuel Injection Hose.....	138
Engine Manifold Repair Kit.....	706
Epoxy, Flexible & Rigid.....	708
Epoxy Putty.....	709
Expansion Plugs:	
Metric.....	74
U.S.....	721
Extension Springs.....	124, 324
Extruded "U" Nuts	70, 106-109
F	
Fan Motors.....	354
Fastener Assortments.....	286-289
Fasteners, Universal Moulding.....	691-693
FasTrack	768
Fax Form.....	718
Fender Shims.....	115-116
Fender Welt.....	358
Fia Clips & Fasteners	577
Fittings:	
Brass.....	233-238
Grease (Metric).....	73, 230
Grease (U.S.).....	228-229
"Fix-Kit" Labels.....	279
"Fix-Kits".....	290-308
Flange Bolts.....	11
Flange Lock Nuts:	
Metric.....	64
U.S.....	11
Flashlights.....	734
Flat Nuts	101
Flex-Fit Rubber Moulding.....	344
Flexible Setting Epoxy.....	708
Fluorescent Work Light.....	734
Foldover Nuts.....	70, 106-109

Footman Loops.....	358
Ford Clips & Fasteners	511-534
“FP” Kits.....	325-327
Frame Bolts.....	11
Free Spinning Washer Nuts:	
Metric.....	64
U.S.....	82
Fuel Line Clips.....	528, 529
Fuel Line Hose.....	138
Fuse Tap.....	173
Fuses, Fuseholders & Acc.....	169-173
Fusible Link Wire.....	163

G

Gas Pump Nozzles & Acc.....	721
Gaskets, Oil Drain Plug.....	222
Gauges.....	731-732
Glass Setting Blocks.....	345
Glass Setting Channel.....	343-344
Glass Shop Supplies	345-353
Gloves.....	712-713
Grease Fittings:	
Accessories	231-232, 735
Metric	73, 230
U.S.	228-229
Grease Guns & Accessories.....	231-232, 735
Green Catalog.....	Color Pages
Grommeting Material.....	333
Grommets:	
Brass	360
Rubber & Vinyl	332, 338
Grooveless Retaining Rings.....	123
Ground Strap, Engine.....	164

H

Hair Pin Cotters.....	125-126
Halogen Headlight Bulbs.....	203-204, 207-209, 211-212
Hammer Drive Anchors.....	715
Handles, Window Crank & Door:	
Ford.....	534
General Motors.....	510
VW.....	689
Hanger Strap.....	720
Harness Connectors.....	174-200
Headlight Adjusting Assy:	
AMC	551
Chrysler	535
Ford	511-512
General Motors	462-464
Toyota	656
VW	682
Headlight Adjusting Springs:	
General Motors.....	464-465
Mazda.....	615
Toyota.....	656
Headlight Bulbs (Halogen) 203-204, 207-209, 211-212.....	712
Headlight Resurfacers.....	724
Headliner Tools.....	168
Heat Shrink Tubing.....	354
Heater Fan Motors.....	137
Heater Hose.....	137
Helical Threaded Inserts	96
Hex Key Sets.....	728
Hex Keys:	
Metric.....	47, 728
Torx®.....	728
U.S.....	728
Hex Lock Nuts (Pal Nuts):	
Metric.....	65
U.S.....	82
Hex Nuts:	
Metric.....	63
U.S.....	78-81
Hinge Bushings (Door).....	509-510, 553, 549
Hinge Pins (Door).....	507-509, 533, 550
Hog Ring Pliers.....	727
Hog Rings.....	359
Hold Down Straps.....	341
Hole Punch.....	736
Hollow Wall Anchors.....	715-716

Honda Clips & Fasteners	577-598
Hood Bumpers.....	338-340
Hood Prop.....	727
Hook, “S”.....	341
Horns & Horn Relay.....	355-356
Hose:	
Air.....	137
Electronic Fuel Injection.....	138
Fuel Line.....	138
Heater.....	137
Vacuum & Windshield Washer (Tubing).....	138
Hose Clamp Pliers.....	701, 727
Hose Clamp Racks.....	281
Hose Clamps	700-703
Hose, Tubing & Wire Dispenser.....	279
Hyundai Clips & Fasteners	598-601

I

Ignition Locks.....	563-565
Import Vehicle Section	567-690
Indicator Lights (Toggle Switch).....	215
Infiniti Clips & Fasteners	601-604
Interchange, OEM	738-767
Interior Trim Buttons.....	357-358
Isuzu Clips & Fasteners	604-605

J

“J” Nuts	67-69, 102-105
“J” Type Cage Nuts.....	105
Jack Nuts®	97
J.I.S. Cap Screws.....	45
J.I.S. Flange Bolts.....	48
J.I.S. Hex Nuts.....	63

K

Key Blanks & Accys	552-566
Key Stock Rack.....	281
Key Stock, Straight.....	130
Keys:	
Hex.....	47, 728
Woodruff.....	130
Kia Clips & Fasteners	605-607
Kits (Green Pages).....	263-328

L

Labels, Bin & Lid.....	279, 284, 714
Land Rover Clips & Fasteners	607
Lexus Clips & Fasteners	607-615
License Plate Nuts & Screws	33-39
Light Bulbs.....	201-212, 713
Lock Accessories.....	563-565
Locking Hole Plugs.....	130
Locks.....	563-565
Loom, Wire.....	162
Lubrication Fittings.....	73, 228-230
Lynch Pins.....	127

M

Machine Screws:	
Metric	42-43
Stainless Steel	14
U.S.	8-10
Magnetic Chucks.....	728
Manifold Repair Kit.....	706
Manifold Studs:	
Metric	41, 62
U.S.	40
Marine Fasteners.....	363-364
Marker Light Assemblies.....	183
Masonry Anchors.....	715
Maxi-Fuses.....	172
Mazda Clips & Fasteners	615-625
Mercedes-Benz Clips & Fasteners	625-630
Mechanics Wire.....	720
Metric Items (Blue Pages)	42-77
Mini-Cooper Clips & Fasteners	631
Mini Fuses.....	172
Miniature Bulb Cabinet.....	279
Miniature Bulbs.....	201-212
Mitsubishi Clips & Fasteners	631-636
Monobolts® & Tools (Rivets).....	249

Moulding Clips:

Acura	567-574
Audi	682-689
BMW	574-577
Chrysler	535-550
Ford	511-534
General Motors	362, 462-510
German Made Ford	577
Honda	577-598
Hyundai	598-601
Infiniti	601-604
Isuzu	604-605
Kia	605-607
Land Rover	607
Lexus	607-615
Mazda	615-625
Mercedes-Benz	625-630
Mini-Cooper	631
Mitsubishi	631-636
Nissan	637-649
Opel	650
Renault	650-651
Saab	651
Subaru	652-655
Suzuki	656
Toyota	656-681
Volkswagen	682-689
Volvo	689-690
Universal	690-693
Window Reveal.....	347-349
Moulding Cutting Tool.....	731
Moulding Tape.....	711

N

“Nipper” Wire Rope Clips	716
Nissan Clips & Fasteners	637-649
Nuts:	
Acorn.....	16, 65, 83
Brass.....	78, 81
Cage.....	67, 81, 105
Collared (Battery).....	166
Cylinder Head, Brass.....	81
Extruded “U”.....	70, 106-109
Flat.....	101
Free Spinning Washer.....	64, 82
Grade 5 Hex, USS & SAE.....	79
Grade 8 Hex, USS & SAE.....	80
Hex:	
Brass.....	78, 81
Flange.....	65
Flange Lock.....	11, 64
Frame (Flange Lock).....	11
Free Spinning Washer.....	64, 82
Grade 5 & Grade 8.....	79, 80
Keys Lock Washer.....	81
Machine Screw.....	16, 78
Metric.....	63
Nylon Insert.....	16, 63, 78
Prevailing Torque.....	78
Reversible Lock.....	78
SAE (Fine).....	79-80
Slotted.....	78
Spin Lock.....	65, 81
USS (Coarse).....	79-80
“J”.....	67-69, 102-105
“J” Type Cage Nuts.....	105
Jack Nuts®.....	97
J.I.S.....	63
License Plate.....	38-39
Lock.....	63-65, 78, 81-82
Metric.....	63-70
Nylon.....	16, 36-39, 63, 78
Pal Nuts:	
Metric.....	65
U.S.....	82
Pushnuts, Bolt Retainers:	
Metric.....	66
U.S.....	82
Self-Threading:	
Metric.....	65-66
U.S.....	83
Specials.....	104-105
Speed (Extruded “U”, Flat, “J”, “U” & Tubular).....	67-70, 100-109

Nuts (Continued)	
Spin Lock:	
Metric	65
U.S.	81
Spring	104
Square	81
Stainless Steel	16
Teenuts	88
Thread Cutting:	
Metric	65-66
U.S.	83
Tubular	67, 100
“U”	67-70, 102-109
Washer Lock Nuts:	
Metric	66
U.S.	82
Well Nuts®	99
Wheel	85-86
Wing:	
Metric	65
U.S.	16, 81
Nutserts®:	
Installation Tool	92
Large Flange Thin Sheet	90
Regular:	
U.S.S. & S.A.E.	91
Thin Sheet	89
Nylon Anchors	715
Nylon Cable Ties	218-221
Nylon Connectors	131-134
Nylon Insert Lock Nuts:	
Metric	63
U.S.	16, 78
O	
“O” Ring Assortments	328
“O” Rings:	
Air Conditioning	331-332
Metric	330
Rubber (U.S.)	329
O.E.M. Electrical Terminals	151-157
O.E.M. Interchange	738-767
Oil Cans	737
Oil Drain Plugs & Gaskets	222-227
Opel Clips & Fasteners	650
P	
PAL Fuses	171
Pal Nuts:	
Metric	65
U.S.	82
Peel-Bak Weatherstrip	334
Piano Wire	352
Pigtail Connectors	174-200
Pins:	
Clevis	127
Cotter:	
Hammerlock, U.S.	127
Metric	74
Stainless Steel	15
Hair Pin	125-126
Lynch	127
Retainer	125
Roll	128
Spring	128
Weld	710
Pipe Fittings	232, 235
Plain White Boxes	729
Plastic & Headlight Resurfacer/Protector	712
Plastic Plug Buttons	129
Plastic & Rubber Restoring Kit	711
Plastic Wrap	711
Pliers, Retaining Ring	123, 727
Plug Buttons, Steel, Nylon & Plastic	129
Plugs:	
Drain	223-227
Expansion:	
Metric	74
U.S.	721
Locking Hole	130
Pipe	232, 235
Poly Plugs	129
Polyethylene Hose Connectors	135

Pop-On Screw Covers & Bases	2, 361
Power Window Lift Motor Gear Kits	353
Power Window Lift Motor	353
Power Window Regulator Gears	353
Prep Pen	726
Prevailing Torque Locknuts	78
Primary Wire	162
Promotional Items	Call Customer Service
Push-On Retainers:	
Metric	66
U.S.	82
Pushnut Bolt Retainers:	
Metric	66
U.S.	82
Pushnut Fasteners	66, 82, 719
Push-Pull Controls	720
Push-Type Retainers	414-460
Push-Type Retainer	
Specification Chart	450-460
Push-Type Wire Connectors	160
Q	
Quik-Select Assortments	314-323
Quik-Select Boxes	314
Quik-Select II Assortments	309-313
Quik-Select II Boxes	309
R	
Racks:	
Hose Clamp	281
Key Stock	281
Threaded Rod	280
Wire Spool	280
Radiator Cooling Fan Motors	354
Razor Blades & Scraper	725
Rear View Mirror Brackets	352
Renault Clips & Fasteners	650-651
Retainers:	
Bolt:	
Metric	66
U.S.	82
Pins	125
Push-On:	
Metric	66
U.S.	82
Push-Type	414-449
Push-Type Specification Chart	450-460
“Xmas Tree”	365-403
“Xmas Tree” Specification Chart	404-413
Retaining Rings & Pliers	72, 117-123
Rigid Setting Epoxy	708
Rivet Guns & Nosepieces	241-243, 249
Rivet Washers	241
Rivets:	
Avex®	247
Blind	239-240, 244-262
Closed-End	250
Drive	239
Klamp-tite	248
Large Secondary Head	248
Monobolt®	249
Multi-Grip	244
Nylon	245-246
Pan'l (Pop®)	239-240
“Peel-Type”	251-253
Plywood	247
Solid Aluminum	239
Specialty	251-261
Stavax® Large Flange	247
Tacking	248
Ultragrip	250
Rod End Ball Joints	694-699
Roll Pins	128
Rough Service Light Bulbs	713
Routing Clips	215-217
Rubber Nut Inserts	98-99
Rubber:	
Bumpers	338-340
Caps	131, 341
Connectors	135
Grommets	332, 338
Hold Down Straps	341
“O” Rings	329-332
Tape	167
Tie Down Straps	341

Weatherstrip	334-337, 342
S	
“S” Hooks	341
Saab Clips & Fasteners	651
Screw Anchors	715
Screw Covers & Bases	2, 361
Screw Pin Anchor Shackles	716
Screws:	
Cap:	
Grade 5	12
Grade 8	13
Metric	43-46
Stainless Steel	15
Drill Point	5
Hex:	
Lag	7
Regular	6
Sems®	4, 7, 20-32
Slotted Washer Head	5, 7
Washer Head:	
Acorn	5
Regular	7
Slotted	5, 7
Tek®	6
Type “F”	5
Lag, Hex Head	7
License Plate	33-38
Machine:	
Metric	42-43
U.S.	8-10, 14
Phillips:	
Hex Washer Head Tapping	5
Flat Head Tapping	2
Flat Head Wood	8
Flat Top Washer Head Tapping	4
Oval Head Machine	8, 14, 42
Oval Head Sems® Tapping	4
Oval Head Sems® Tek®	4
Oval Head Tapping	1, 14
Oval Head Tek® Tapping	1, 4, 7
Pan Head Machine	9, 42
Pan Head Sems® Tapping	4
Pan Head Tapping	3, 14
Pan Head Tek®	6
Pan Head Tri-Lobular	5
Round Head Machine	9, 14
Self-Piercing	5
Set	10, 47
Slotted:	
Fillister Head Metric	42
Flat Head Machine	43
Hex Head Self-Piercing	5
Hex Head Tapping	7
Hex Washer Head Tapping	7
Oval Head Tapping	1
Pan Head Machine	42
Pan Head Tapping	3
Pan Head Type “F”	5
Round Head Machine	9, 14
Socket Head Cap (Metric)	46
Socket Head Set:	
Metric	47
U.S.	10
Specialty	23-32, 54-62
Stainless Steel	14-15
Stove Bolts	9
Tapping	1-7, 14, 23-32, 54-62
Tek®	1, 4, 6, 29-32, 55-60
Torx®:	
Drive Floor	3
Pan Head Tapping	2, 57
Metric	2, 57
U.S.	3
Tri-Lobular (“TT”)	5
Trim	1-7
Wood, Flat Head	8
Sealer, Automotive	707
Self-Threading Nuts:	
Metric	66
U.S.	83
Seam-N-Joint Sealer	707
Set Screws	10, 47
Shackles	716
Shaft Collars	718
Sheet Metal Plugs	129

Shims.....	115-116
Snaps.....	363-364
Socket Wrenches.....	728
Sockets, Electrical.....	174-200
Solder Paste.....	710
Solderless Terminals.....	139-157
Sound Dampening Pads.....	712
Speed Nuts®.....	67-70, 100-109
Split Flexible Tubing.....	162
Sponge Rubber Weatherstrip	334-337, 342
Spring Nuts	104
Spring Pins.....	128
Springs:	
Extension & Compression.....	124-125, 324
Truck Seat.....	461
Stainless Steel Fasteners	14-16
Stainless Steel Grease Fittings.....	230
Stand-Offs, Nylon.....	717
Starter Bolts.....	22
Stove Bolts.....	9
Straight Keys.....	130
Strain Relief Cable Connector.....	216
Strap, Engine Ground.....	164
Strap, Perforated Hanger.....	720
Straps, Rubber Tie Down.....	341
Studs, Manifold:	
Metric.....	41, 62
U.S.....	40
Subaru Clips & Fasteners	652-655
Suction Gun.....	737
Suzuki Clips & Fasteners	656
Switches:	
Horn Button.....	213
Push-Pull.....	213
Toggle.....	213-214
T	
" T " Nuts.....	88
Tape:	
Electrical.....	167
Moulding.....	711
Rubber.....	167
Tapping Screws	1-7, 14, 23-32, 54-62
Tee Rubber.....	344
Teenuts.....	88
Test Clips.....	163
Terminals:	
Battery.....	164-166
Electrical.....	139-157
Thread Cutting Nuts:	
Metric.....	65-66
U.S.....	83
Thread Cutting Screws.....	5
Threaded Inserts:	
Helical.....	96
Nutserts®.....	89-92
Thread Repair.....	93-95
Threaded Rod Rack.....	280
Throttle Rod Clips.....	125
Ties, Cable (& Mounts).....	218-221
Tire Valves.....	333
Toggle Bolts & Anchors.....	715-716
Toggle Switches.....	213-214
Tools:	
Awls.....	726
Battery Tools.....	167
Bolt Extractor Kit.....	730
Cable Tie Tool.....	221
Caulking Guns.....	736
Circuit Tester.....	161
Clip Removal Tool.....	723-724
Cut-Off Wheels & Mandrels.....	733
Drill-Out® Bolt Extractor.....	730
Door Handle Clip Tool.....	724
Electrical Connector Separator.....	158
Electrical Crimping Tools.....	158-159, 167
Flash Lights.....	734
Gauges.....	731-732
Glass Shop.....	723-725
Grease Guns.....	231-232, 735
Headliner Tools.....	724
Hex Key Sets.....	728
Hog Ring Pliers.....	727
Hole Punch.....	736
Hood Prop.....	727

Tools (Cont'd):	
Hose Clamp Pliers.....	701, 727
Hose Cutter.....	731
Jack Nut® Installation Tool.....	98
Knife (Carpet).....	725
Knife & Scissors Sharpener.....	724
Magnetic Chucks.....	728
Moulding Cutting Tool.....	731
Nutsert® Installation Tool.....	92
Pick ("O" Ring & Seal).....	726
Pliers, Retaining Ring.....	123, 127
Prep Pen.....	726
Razor Blade Scraper.....	725
Retaining Ring Pliers.....	123, 727
Revolving Punch.....	736
Rivet Guns & Nosepieces.....	241-243, 249
Seat Spring Wire Bender.....	461, 735
Sharpener.....	724
Suction Gun.....	737
Terminal Extractor Picks.....	157
Test Clips.....	163
Torx® Bits & Drivers.....	2, 58, 728
Trim Pad Removal Tool.....	724
Truck Seat Spring Bending Tool.....	461, 735
Tweezers.....	735
Windshield Moulding Tools.....	723
Windshield Wiper Arm Remover.....	723
Toughcoat Light Bulbs.....	713
Torx® Bits & Drivers.....	2, 58, 728
Toyota Clips & Fasteners	656-681
Trailer Connectors.....	199-200
Trim Clips.....	357-358
Trimming Sundries & Fasteners	357-413
Truck Seat Spring Wire Bender.....	461, 735
Truck Seat Springs.....	461
Truck Wheel Hardware.....	84-87
Tubeless Tire Valves.....	333
Tubing:	
Clamps.....	216, 704-705
Clear Vinyl (PVC).....	137, 718
Connectors:	
Brass.....	238
Nylon.....	131-134
Dispenser.....	279
Heat Shrink.....	168
Vacuum & Windshield Washer.....	138
Tubular Nuts	67, 100
Tumblers (Lock).....	563
U	
"U" Nuts.....	67-70, 102-109
Universal Moulding Clips	691-693
Universal Springs.....	124
V	
Vacuum:	
Rubber & Vinyl Caps	131
Tubing.....	138
Tubing Connectors.....	131-135
Vacuum & Windshield Washer Tubing.....	138
Valves, Tubeless Tire.....	333
Vent Window Seals.....	342
Vibration Dampening Pads.....	712
Vinyl Caps.....	131, 341
Vinyl Grommets.....	332
Vinyl Tubing.....	137, 718
Volkswagen Clips & Fasteners	682-689
Volvo Clips & Fasteners	689-690
W	
Washer Cap Type Pushnut® Fasteners.....	719
Washer Lock Nuts:	
Metric.....	66
U.S.....	82
Washer Type Self-Threading Nuts:	
Metric.....	66
U.S.....	83
Washers:	
Belleville.....	112
Bowed Spring.....	112
Copper:	
Metric.....	71
U.S.....	112

Washers (Cont'd):	
Countersunk.....	110, 360
Countersunk Lock.....	113
Fender.....	112
Finishing (Nylon).....	110, 361
Flanged.....	110, 360
Flat:	
Metric.....	71
U.S.....	16, 110
Flush.....	110, 360
High Strength, U.S.S. & S.A.E.....	110
Internal & External Combo Lock.....	114
Lock.....	16, 71, 112-114
Metric.....	71
Nylon Finishing.....	110, 361
Nylon Flat.....	114
Rivet.....	241
S.A.E.....	110
Split Lock, Regular & High Alloy.....	112
Spring Wave, Metric.....	71
Stainless Steel.....	16
Tooth (Internal, External & Countersunk).....	113-114
USS Wought.....	110
Vibration Proof.....	113
Wave, Metric.....	71
Wrought (USS).....	111
"X".....	114
Weather-Seal Wrap.....	711
Weatherpack Terminals.....	151-152
Weatherstrip	334-337, 342
Weatherstrip For Glass.....	342-344
Weld Pins.....	710
Welding Blanket.....	710
Well Nuts®.....	99
Welt, Fender.....	358
Wheel Studs & Nuts.....	84-87
Windlace Cord.....	337
Window Channels.....	342-344
Window Crank Handle Clips.....	346-347
Window Crank Handles:	
Ford.....	534
General Motors.....	510
VW.....	689
Window Guides.....	350-351
Window Lift Motor Gear Kit.....	353
Window Lift Motor.....	353
Window Regulator Drive Block.....	352
Window Regulator Gear.....	353
Window Reveal Moulding Clips.....	347-349
Window Rubber Moulding.....	344
Windshield Moulding Clip Tool.....	723
Windshield Washer & Vacuum Tubing.....	138
Wire:	
Bending Tool (Truck Seat Spring).....	461, 735
Fusible Link Wire.....	163
Loom.....	162
Loom Clips & Straps.....	215-221
Mechanics Wire.....	720
Piano Wire.....	352
Primary Wire.....	162
Rope Clips (Nipper).....	716
Rope Thimbles.....	716
Wire Nuts.....	160
Wire Spool Racks.....	280
Woodruff Keys.....	130
Work Light.....	734
X	
"X"- Washers.....	114
"Xmas Tree" Retainers.....	365-413
Y	
Yoke Ends.....	128, 700

NUMERICAL INDEX

Auveco No.	Page	Auveco No.	Page	Auveco No.	Page	Auveco No.	Page	Auveco No.	Page	Auveco No.	Page	Auveco No.	Page
AP448L	263	BH3	209	10-HCR	281	154	233	320	236	443	238	1456	3
Ap448S	263	BH7	209	11	346	155	233	321	236	448	238	1457	3
AuvecoPaks	263	BH9	209	18-CB	282	158	233	322	236	455	238	1458	3
B-1	283	BH10	209	18-D	283	159	233	325	236	456	238	1459	3
B-2	283	BH11	209	30	233	161	233	326	236	457	238	1460	3
B-3	298	BH13	209	31	233	162	233	327	236	461	238	1479	2
B24	206			32	233	163	233	328	236	462	238	1483	1
B24A	206			33	233	164	233	329	236	463	238	1700	112
B53	206			35	233	165	233	330	236	464	238	1712	2
B57	206			36	233	168	233	331	236	465	238	1717	1
B67	206			37	233	182	234	332	236	602	110	1720	357
B67A	206			38	233	186	234	333	236	604	110	1780	6
B68	206			39	233	187	234	334	236	612	110	1781	6
B89	206			45	233	188	234	335	236	614	110	1787	3
B97	206			46	233	189	234	336	236	616	110	1793	1
B168	206			47	233	192	234	337	236	618	110	1794	1
B194	206			49	233	193	234	339	236	619	110	1796	1
B194-100	206			50	233	194	234	340	236	727	78	1797	1
B194A	206			51	233	198	234	341	236	728	78	1798	1
B880	207			52	233	200	234	342	236	729	78	1799	1
B881	207			53	233	201	234	343	236	730	78	1800	1
B884	207			68-RACK	314	211	234	344	236	731	78	1801	1
B885	207			68-6	314	221	234	345	236	733	78	1802	1
B886	207			68-12	314	223	234	347	236	768	112	1803	1
B889	207			68-18	314	224	234	348	236	807	357	1804	1
B890	207			68-106	314	230	234	349	236	808	357	1826	27
B891	207			68-112	314	231	234	350	236	1001	707	1863	8
B893	207			68-118	314	232	234	351	236	1002	707	1877	8
B894	208			69-RACK	309	233	234	352	236	1005	NI 36	1896	101
B896	208			69-12	309	234	234	353	236	1006	NI 36	1898	101
B899	208			69-18	309	235	234	354	236	1007	709	1899	101
B906	206			69-24	309	244	235	355	236	1008	709	1900	101
B906A	206			69-112	309	245	235	356	236	1020	287	1903	101
B912	206			69-118	309	246	235	357	236	1021	287	1905	101
B916	206			69-124	309	247	235	359	236	1030	287	1906	101
B916A	206			72B-9	282	261	235	360	236	1031	287	1907	103
B921	206			69	233	262	235	370	237	1040	287	1912	101
B921A	206			70	233	263	235	371	237	1041	287	1913	103
B1141	206			72	233	264	235	372	237	1042	287	1932	1
B1156	206			73	233	265	235	374	237	1043	287	1933	1
B1156A	206			75	233	266	235	385	237	1052	285	1934	8
B1157	206			76	233	268	235	398	237	1053	285	1935	3
B1157A	206			77	233	269	235	399	237	1054	285	1936	3
B1893	206			78	233	287	235	401	237	1055	285	1937	3
B1895	206			90	233	288	235	404	237	1092	3	1939	3
B2057	206			91	233	289	235	405	237	1137	1	1940	3
B2057A	206			96	233	290	235	406	237	1144	1	1942	3
B2357	206			101	233	291	235	413	238	1146	3	1943	3
B2357A	206			102	233	292	235	415	238	1149	1	1946	2
B3057	206			103	233	293	235	416	238	1183	112	2007	112
B3057A	206			105	233	294	235	417	238	1202	358	2008	112
B3156	206			107	233	295	235	418	238	1256	357	2012	6
B3156A	206			110	233	296	235	419	238	1263	3	2024	1
B3157	206			111	233	297	235	420	238	1265	3	2027	1
B3157A	206			112	233	298	235	421	238	1266	3	2028	30
B3357	206			113	233	299	235	422	238	1267	346	2039	3
B3357A	206			114	233	300	235	423	238	1294	112	2046	1
B3457	206			116	233	301	235	424	238	1313	36	2057	103
B3457A	206			119	234	302	235	425	238	1340	215	2089	101
B4114K	206			120	234	303	235	426	238	1341	215	2091	101
B4157	206			121	234	304	235	427	238	1344	3	2092	101
B4157K	206			122	234	305	235	428	238	1346	3	2098	101
B7440	206			123	234	306	235	429	238	1347	3	2099	101
B7440A	206			124	234	307	235	430	238	1376	112	2100	101
B7443	206			125	234	308	235	431	238	1381	3	2102	101
B7443A	206			126	234	309	235	432	238	1382	3	2103	101
B9004	208			127	234	310	235	433	238	1413	8	2105	101
B9005	208			128	234	311	235	434	238	1421	1	2107	6
B9006	208			134	234	313	235	435	238	1423	1	2109	6
B9007	208			135	234	314	235	437	238	1424	1	2110	6
BD1S	208			137	234	315	235	438	238	1432	1	2178	30
BD2C	208			150	233	316	236	439	238	1452	3	2209	21
BD2R	209			151	233	317	236	440	238	1453	3	2227	112
BD2S	209			152	233	318	236	441	238	1454	3	2262	88
BH1	209			153	233	319	236	442	238	1455	3	2266	6

NUMERICAL INDEX

Auveco No.	Page	Auveco No.	Page	Auveco No.	Page	Auveco No.	Page	Auveco No.	Page	Auveco No.	Page	Auveco No.	Page
2267	6	2585	1	2943	691	3212	6	3512	127	3878	130	4246	338
2268	6	2586	1	2967	7	3214	6	3513	127	3879	130	4248	338
2269	6	2595	100	2968	7	3215	6	3515	127	3880	130	4249	339
2272	357	2597	110	2969	7	3216	6	3519	127	3881	130	4250	339
2288	346	2598	125	2973	7	3217	6	3520	127	3882	130	4258	338
2293	103	2604	7	2974	7	3219	6	3521	127	3883	130	4260	338
2299	8	2605	7	2976	7	3220	6	3522	127	3884	130	4264	339
2303	103	2611	100	2978	7	3249	81	3524	127	3885	130	4265	338
2309	357	2619	692	2979	7	3250	81	3526	127	3886	130	4266	340
2310	357	2625	38	2980	7	3342	7	3537	4	3887	130	4273	339
2330	7	2628	348	2981	7	3350	7	3538	4	3888	130	4280	338
2333	112	2632	1	2983	7	3352	7	3539	4	3889	130	4281	340
2346	102	2633	1	2988	7	3367	7	3541	79	3890	130	4305	329
2354	8	2656	1	2989	7	3368	7	3542	79	3891	130	4306	329
2358	1	2657	1	2991	7	3369	7	3543	79	3892	130	4307	329
2359	1	2661	1	2994	7	3373	7	3544	79	3893	130	4308	329
2360	1	2662	1	2996	7	3374	7	3545	79	3894	130	4309	329
2361	1	2663	1	2999	115	3375	7	3546	79	3895	130	4310	329
2362	1	2665	1	3000	115	3376	7	3547	79	3896	130	4311	329
2364	3	2666	1	3020	3	3378	7	3548	79	3929	111	4312	329
2365	3	2672	123	3022	3	3379	7	3549	79	3930	111	4313	329
2366	3	2688	8	3024	3	3380	7	3550	79	3931	111	4314	329
2367	3	2698	1	3028	3	3381	7	3552	112	3932	111	4315	329
2369	7	2699	1	3032	3	3382	7	3553	112	3933	111	4316	329
2370	7	2700	1	3036	3	3383	7	3554	112	3935	111	4317	329
2385	357	2702	1	3062	1	3385	7	3556	112	3937	721	4318	329
2389	6	2704	1	3063	1	3386	7	3609	125	3938	721	4319	329
2420	103	2705	1	3068	1	3387	7	3610	125	3939	721	4320	329
2422	103	2706	1	3069	1	3388	7	3611	125	3941	721	4321	329
2426	101	2707	1	3071	3	3389	7	3612	125	3942	721	4322	329
2452	115	2709	1	3072	3	3390	7	3613	125	3943	721	4323	329
2453	115	2710	1	3073	3	3392	7	3614	125	3944	721	4324	329
2472	37	2711	1	3074	3	3393	7	3615	8	3945	721	4347	329
2485	6	2712	1	3075	3	3394	7	3616	105	3946	721	4348	329
2486	6	2713	1	3076	3	3400	83	3617	362	3947	721	4349	329
2487	6	2716	1	3077	3	3401	83	3620	382	3949	721	4350	329
2515	110	2717	1	3078	3	3402	83	3628	123	3950	721	4351	329
2530	9	2718	1	3079	3	3403	83	3639	382	3952	721	4352	329
2531	9	2720	1	3080	3	3404	83	3682	38	3953	721	4353	329
2532	9	2722	1	3081	3	3405	83	3690	218	3956	721	4354	329
2533	9	2726	1	3082	3	3414	17	3708	127	3957	721	4355	329
2534	9	2724	1	3083	3	3415	17	3709	127	3958	721	4356	329
2535	9	2727	1	3084	3	3432	17	3711	9	3960	721	4357	339
2536	9	2728	1	3085	3	3433	17	3712	9	3961	721	4369	339
2537	9	2729	1	3086	3	3434	17	3713	9	3962	721	4406	338
2538	9	2730	1	3087	3	3435	17	3715	9	3963	721	4408	332
2539	9	2731	1	3088	3	3438	17	3716	9	3964	721	4410	332
2540	9	2734	1	3089	3	3465	4	3717	9	3965	721	4411	332
2541	9	2735	1	3090	3	3466	4	3718	9	3966	721	4413	332
2542	9	2736	2	3091	3	3467	4	3719	9	3967	721	4414	332
2543	9	2744	691	3092	3	3468	4	3720	9	3968	721	4415	332
2544	9	2751	4	3093	3	3469	110	3722	9	3969	721	4417	332
2545	9	2752	692	3099	17	3470	110	3724	9	3971	721	4418	332
2546	9	2753	8	3100	17	3471	110	3741	81	3975	82	4419	332
2548	9	2769	81	3102	17	3472	110	3743	81	3984	111	4420	332
2550	9	2771	4	3135	345	3483	1	3750	129	3985	111	4421	332
2554	82	2772	4	3137	100	3484	1	3751	129	3986	111	4422	332
2555	82	2773	4	3138	101	3492	81	3752	129	3987	111	4423	332
2556	82	2774	4	3144	81	3493	81	3753	129	3988	111	4425	332
2557	82	2775	4	3155	115	3494	81	3754	129	3989	111	4426	332
2558	82	2789	692	3156	115	3495	81	3755	129	3990	111	4428	332
2560	82	2802	1	3165	123	3496	81	3756	129	3991	111	4429	332
2561	82	2803	2	3166	123	3497	81	3758	215	3992	111	4430	332
2562	82	2804	2	3167	123	3498	81	3770	103	3993	111	4431	332
2565	100	2805	26	3168	125	3499	81	3776	100	4155	339	4432	332
2571	1	2806	28	3176	125	3500	81	3777	100	4188	338	4433	332
2572	1	2807	2	3178	464	3501	81	3793	101	4204	339	4434	332
2574	1	2808	3	3182	36	3502	127	3796	102	4233	339	4435	332
2575	1	2809	7	3183	36	3503	127	3797	103	4235	338	4436	332
2578	1	2810	2	3184	36	3504	127	3798	81	4236	339	4439	131
2579	1	2818	691	3186	166	3505	127	3824	122	4237	338	4440	341
2580	1	2850	359	3205	1	3506	127	3854	8	4240	339	4441	339
2581	1	2895	83	3207	1	3508	127	3859	8	4242	338	4446	339
2582	1	2896	83	3209	464	3509	127	3868	78	4243	338	4447	339
2583	1	2897	83	3211	3	3511	127	3877	130	4244	339	4448	341

NUMERICAL INDEX

Auveco No.	Page	Auveco No.	Page	Auveco No.	Page	Auveco No.	Page	Auveco No.	Page	Auveco No.	Page	Auveco No.	Page
4449	341	5000	148	5258	113	5405	10	5505	12	5723	112	6178	295
4450	341	5002	148	5259	113	5406	10	5510	12	5724	112	6182	291
4451	341	5003	148	5260	113	5407	10	5512	12	5748	239	6186	293
4453	138	5005	148	5261	113	5408	10	5513	12	5749	239	6187	295
4454	138	5006	148	5262	113	5409	10	5514	12	5750	239	6501	300
4456	138	5007	148	5263	113	5410	10	5516	12	5751	239	6502	302
4457	138	5008	148	5264	113	5411	10	5524	12	5752	239	6503	300
4459	138	5009	148	5265	113	5412	10	5526	12	5753	239	6504	303
4460	138	5010	148	5266	113	5413	10	5527	12	5754	240	6505	306
4462	138	5014	148	5267	113	5414	728	5528	12	5755	240	6506	303
4463	138	5015	148	5268	113	5415	728	5530	12	5759	5	6507	303
4464	138	5021	140	5270	113	5417	728	5533	12	5764	5	6508	303
4465	138	5023	140	5271	113	5434	12	5537	12	5766	5	6509	304
4466	138	5024	140	5272	113	5435	12	5538	12	5767	5	6510	304
4467	138	5026	140	5274	113	5436	12	5539	12	5768	5	6511	305
4468	138	5027	140	5278	35	5438	12	5542	12	5769	5	6513	301
4473	340	5028	141	5290	5	5439	12	5547	12	5773	5	6514	301
4474	340	5029	141	5291	5	5440	12	5550	12	5774	5	6517	306
4511	343	5030	141	5292	5	5441	12	5551	12	5775	5	6519	306
4512	343	5031	141	5298	5	5442	12	5553	12	5776	5	6520	306
4513	343	5032	141	5301	5	5443	12	5563	101	5778	5	6522	306
4515	343	5033	140	5307	5	5444	12	5571	102	5781	5	6523	304
4516	343	5034	140	5329	6	5445	12	5576	103	5782	5	6524	302
4530	344	5035	140	5330	6	5446	12	5586	105	5783	5	6525	305
4531	344	5036	140	5331	6	5447	12	5589	105	5784	5	6530	300
4581	344	5037	141	5332	6	5448	12	5592	383	5786	5	6532	301
4588	343	5038	140	5347	702	5449	12	5596	81	5787	5	6533	300
4654	337	5040	140	5348	702	5450	12	5600	123	5788	464	6534	305
4655	337	5041	141	5349	702	5451	12	5601	123	5789	464	6535	303
4656	337	5044	148	5350	702	5452	12	5602	122	5791	139	6536	300
4670	343	5045	148	5351	702	5453	12	5603	122	5792	139	6537	307
4671	343	5046	148	5352	702	5454	12	5616	1	5793	139	6538	302
4675	336	5047	140	5354	702	5455	12	5617	1	5794	166	6539	300
4688	343	5048	140	5357	702	5456	12	5618	1	5796	166	6540	301
4703	336	5049	141	5358	702	5457	12	5619	3	5836	102	6541	301
4707	336	5056	141	5365	10	5459	12	5621	3	5854	100	6542	307
4731	336	5058	141	5366	10	5461	12	5623	3	5879	218	6543	304
4736	337	5059	144	5367	10	5462	12	5625	3	5885	36	6544	304
4737	337	5062	144	5368	10	5463	12	5626	3	5889	693	6545	306
4738	337	5063	144	5369	10	5464	12	5629	3	5908	35	6546	307
4740	337	5066	148	5370	10	5465	12	5630	3	5909	35	6547	308
4742	336	5067	142	5371	10	5466	12	5632	3	5910	36	6548	307
4743	337	5068	142	5372	10	5467	12	5633	3	5961	358	6549	307
4744	336	5072	140	5373	10	5468	12	5634	3	6003	291	6550	307
4745	336	5074	116	5374	10	5469	12	5636	3	6004	291	6551	308
4746	336	5075	116	5375	10	5470	12	5639	3	6007	292	6552	308
4747	336	5076	116	5376	10	5471	12	5642	3	6011	292	6553	305
4749	336	5077	116	5377	10	5472	12	5645	3	6038	291	6554	302
4750	337	5096	116	5378	10	5473	12	5646	2	6043	293	6555	307
4800	334	5097	116	5379	10	5474	12	5647	2	6051	294	6556	306
4801	334	5167	81	5380	10	5475	12	5648	2	6062	297	6557	305
4802	334	5170	105	5381	10	5476	12	5649	2	6065	296	6558	305
4803	334	5195	100	5382	10	5477	12	5650	2	6070	292	6601BHM	270
4804	334	5196	100	5383	10	5478	12	5651	2	6073	292	6602BHM	270
4805	334	5197	103	5384	10	5479	12	5653	2	6085	294	6603BHM	270
4806	334	5219	197	5385	10	5480	12	5654	2	6086	293	6604BHM	271
4807	334	5220	197	5386	10	5481	12	5655	2	6112	294	6605BHM	271
4808	334	5221	197	5387	10	5482	12	5656	2	6116	294	6606BHM	271
4809	334	5225	197	5388	10	5483	12	5660	2	6123	293	6607BHM	271
4810	334	5226	197	5389	10	5484	12	5661	2	6124	296	6608BHM	271
4811	334	5228	38	5390	10	5485	12	5672	2	6125	296	6609BHM	271
4812	334	5238	17	5391	10	5486	12	5676	6	6128	295	6610BHM	271
4813	334	5239	17	5392	10	5487	12	5697	9	6133	297	6611BHM	271
4850	334	5242	17	5393	10	5488	12	5700	9	6144	291	6612BHM	271
4851	334	5243	17	5394	10	5489	12	5702	9	6158	294	6613BHM	272
4852	334	5246	17	5395	10	5490	12	5704	9	6160	292	6614BHM	272
4853	334	5249	113	5396	10	5491	12	5711	8	6162	297	6615BHM	272
4854	334	5250	113	5397	10	5492	12	5713	8	6164	293	6616BHM	272
4855	334	5251	113	5398	10	5493	12	5714	17	6166	296	6617BHM	272
4856	334	5252	113	5399	10	5494	12	5717	112	6167	297	6618BHM	272
4857	334	5253	113	5400	10	5495	12	5718	112	6168	297	6619BHM	272
4858	334	5254	113	5401	10	5497	12	5719	112	6172	293	6620BHM	272
4859	334	5255	113	5402	10	5499	12	5720	112	6173	295	6621BHM	276
4860	334	5256	113	5403	10	5500	12	5721	112	6175	295	6622BHM	275
4861	334	5257	113	5404	10	5501	12	5722	112	6176	297	6623BHM	275

NUMERICAL INDEX

Auveco No.	Page	Auveco No.	Page	Auveco No.	Page	Auveco No.	Page	Auveco No.	Page	Auveco No.	Page	Auveco No.	Page
6624BHM	275	6857	317	7677	363	8296	240	8503	127	8710	122	8895	239
6625BHM	276	6858	316	7678	363	8297	240	8506	127	8711	122	8896	239
6626BHM	276	6859	319	7679	363	8298	240	8507	127	8712	122	8897	239
6627BHM	276	6861	318	7680	363	8299	240	8508	127	8715	120	8898	239
6628BHM	274	6862	318	7681	363	8300	240	8509	127	8719	719	8899	239
6629BHM	273	6863	318	7682	363	8301	240	8511	127	8742	85	8900	239
6630BHM	273	6864	321	7683	363	8302	239	8516	127	8744	85	8901	239
6631BHM	274	6865	321	7688	363	8303	239	8518	127	8746	85	8902	239
6632BHM	275	6866	320	7690	363	8304	239	8521	127	8750	175	8903	239
6633BHM	275	6867	319	7691	363	8305	239	8530	127	8751	175	8905	240
6634BHM	273	6868	318	7692	363	8306	240	8545	100	8754	175	8906	240
6635BHM	273	6869	317	7707	359	8307	240	8546	100	8755	174	8907	240
6636BHM	273	6870	322	7711	159	8308	240	8550	218	8756	175	8908	240
6637BHM	275	6871	322	7767	728	8309	240	8552	17	8759	174	8909	240
6638BHM	275	6901	311	7771	358	8310	240	8557	17	8761	184	8911	240
6639BHM	275	6902	311	7772	358	8311	240	8562	17	8763	197	8912	240
6640BHM	276	6903	311	7773	358	8312	240	8578	100	8764	197	8913	240
6641BHM	274	6904	311	7778	724	8313	240	8581	692	8768	199	8914	240
6642BHM	273	6905	311	7909	123	8337	102	8583	347	8769	199	8915	240
6643BHM	274	6906	311	7910	123	8341	103	8588	9	8770	199	8917	240
6644BHM	274	6907	312	7914	723	8359	106	8589	9	8772	164	8918	240
6645BHM	274	6908	312	7915	241	8372	106	8590	9	8773	164	8919	240
6646BHM	276	6910	313	7965	728	8375	106	8594	9	8774	153	8920	240
6647BHM	NI 7	6911	312	7976	728	8377	106	8605	111	8775	153	8922	240
6648BHM	NI 7	6912	313	7977	728	8385	693	8606	111	8776	153	8923	240
6649BHM	NI 7	6913	313	7978	728	8386	693	8607	111	8777	153	8924	240
6650BHM	270	6914	312	7981	241	8398	693	8608	111	8781	142	8925	240
6699BHM	274	6915	313	7982	241	8399	693	8609	111	8788	144	8926	240
6801	321	6916	313	7983	241	8400	693	8610	111	8814	107	8927	240
6802	321	6917	312	7984	241	8418	39	8611	111	8824	122	8928	240
6803	321	6918	NI 6	7985	241	8419	535	8612	111	8825	122	8929	240
6804	322	6919	312	7986	241	8427	37	8613	111	8826	122	8930	240
6805	322	6920	310	7996	167	8435	39	8621	111	8827	122	8931	240
6806	320	6921	310	7999	724	8437	5	8623	18	8828	122	8932	240
6807	321	6923	310	8003	166	8438	5	8624	18	8829	122	8933	240
6808	316	6924	310	8009	144	8439	5	8625	18	8830	122	8934	240
6809	321	6929	310	8013	129	8441	5	8626	17	8831	122	8935	240
6810	315	6930	311	8029	9	8442	5	8627	17	8832	122	8936	240
6811	316	6931	311	8030	9	8443	5	8649	112	8833	122	8937	240
6812	315	6933	311	8031	9	8444	5	8650	112	8834	122	8938	240
6813	315	6934	312	8033	9	8445	115	8659	79	8835	122	8939	240
6814	316	6935	312	8035	9	8447	693	8660	79	8836	123	8940	240
6815	317	6936	313	8036	9	8448	693	8661	79	8837	123	8941	349
6816	317	6937	312	8044	1	8449	12	8662	79	8843	693	8942	465
6817	317	7137	110	8050	1	8450	12	8663	79	8847	22	8944	26
6818	318	7138	110	8056	1	8453	12	8665	719	8853	380	8954	39
6820	319	7143	110	8061	1	8454	12	8676	120	8855	83	8963	722
6821	320	7145	110	8062	1	8455	12	8677	120	8858	82	8964	722
6822	321	7147	110	8068	1	8456	12	8678	120	8861	82	8971	722
6825	319	7148	110	8083	1	8477	127	8679	120	8862	82	8981	128
6826	318	7340	360	8096	12	8478	127	8680	120	8863	82	8983	128
6827	320	7341	360	8097	12	8479	127	8682	120	8864	82	8985	128
6829	322	7342	360	8104	12	8480	127	8683	120	8865	82	8987	128
6830	318	7343	360	8105	12	8481	127	8688	120	8867	82	8988	128
6831	318	7344	360	8107	12	8482	127	8689	120	8868	82	8989	128
6834	323	7347	360	8206	357	8483	127	8690	120	8869	82	8991	128
6835	320	7348	360	8242	39	8484	127	8691	120	8871	239	8992	128
6836	319	7349	360	8249	35	8485	127	8692	120	8872	239	8993	128
6837	322	7350	360	8250	36	8486	127	8693	120	8873	239	8994	128
6838	323	7409	364	8272	218	8487	127	8694	120	8874	239	8995	128
6839	323	7417	364	8273	218	8488	127	8695	120	8875	239	8996	128
6840	320	7419	364	8277	222	8489	127	8696	120	8877	239	8997	128
6841	320	7432	364	8278	222	8490	127	8697	120	8879	239	8998	128
6842	319	7578	359	8279	222	8491	127	8698	120	8880	239	8999	128
6843	319	7595	359	8281	222	8492	127	8699	120	8881	239	9000	128
6845	321	7613	110	8285	227	8493	127	8700	122	8882	239	9001	128
6846	321	7615	110	8286	227	8494	127	8701	122	8883	239	9002	128
6847	321	7616	110	8288	227	8495	127	8702	122	8884	239	9003	128
6848	315	7618	110	8289	227	8496	127	8703	122	8886	239	9004	128
6850	315	7624	110	8290	239	8497	127	8704	122	8887	239	9005	128
6851	315	7625	110	8291	239	8498	127	8705	122	8888	239	9006	128
6852	316	7644	359	8292	239	8499	127	8706	122	8889	239	9007	128
6853	316	7657	727	8293	239	8500	127	8707	122	8892	239	9008	128
6854	316	7658	727	8294	240	8501	127	8708	122	8893	239	9009	128
6856	317	7672	724	8295	240	8502	127	8709	122	8894	239	9010	128

NUMERICAL INDEX

Auveco No.	Page	Auveco No.	Page	Auveco No.	Page	Auveco No.	Page	Auveco No.	Page	Auveco No.	Page	Auveco No.	Page
9011	128	9142	13	9292	129	9489	10	9605	6	9800	130	10104	134
9012	128	9143	13	9293	129	9490	10	9606	6	9801	130	10105	134
9013	128	9144	13	9297	82	9491	10	9607	6	9802	130	10106	134
9015	128	9145	13	9298	82	9492	10	9608	6	9814	363	10107	134
9016	128	9146	13	9299	82	9493	10	9609	6	9825	7	10108	134
9017	128	9147	13	9300	80	9494	10	9610	6	9829	465	10109	134
9018	128	9148	13	9301	80	9498	10	9611	6	9846	81	10110	134
9019	128	9149	13	9302	80	9499	10	9612	6	9850	471	10116	122
9021	128	9150	13	9303	80	9500	10	9613	6	9851	464	10117	122
9022	128	9151	13	9304	80	9501	10	9614	6	9853	18	10118	122
9023	128	9152	13	9305	80	9502	10	9615	6	9854	18	10120	122
9024	128	9153	13	9306	80	9503	10	9616	6	9855	18	10121	122
9025	128	9154	13	9307	80	9507	10	9617	6	9862	513	10122	122
9026	128	9155	13	9308	80	9509	10	9620	6	9863	26	10123	122
9027	128	9156	13	9309	80	9510	10	9625	102	9864	215	10124	122
9028	128	9157	13	9310	80	9520	12	9630	112	9866	699	10125	122
9029	128	9158	13	9311	80	9521	12	9633	347	9869	699	10126	122
9030	128	9159	13	9312	80	9522	12	9636	221	9877	26	10127	122
9031	128	9160	13	9324	702	9523	12	9637	221	9879	104	10128	122
9033	128	9161	13	9342	362	9524	12	9639	347	9880	104	10129	122
9034	128	9162	13	9353	349	9525	12	9643	239	9881	104	10130	122
9035	128	9163	13	9354	19	9526	12	9644	239	9882	349	10131	122
9036	128	9164	13	9355	19	9528	12	9647	239	9883	174	10132	122
9037	128	9165	13	9356	19	9529	12	9648	239	9884	183	10133	122
9038	128	9167	13	9357	702	9535	78	9667	40	9885	183	10134	123
9039	128	9169	13	9358	702	9536	78	9668	40	9886	346	10135	123
9040	128	9170	13	9361	357	9537	78	9669	40	9890	125	10162	1
9042	128	9171	13	9367	501	9538	78	9670	40	9892	125	10163	1
9043	128	9172	13	9377	535	9539	78	9673	40	9894	125	10164	1
9044	128	9174	13	9381	705	9540	78	9674	40	9900	199	10165	1
9045	128	9177	13	9382	705	9541	78	9675	40	9901	199	10166	1
9046	128	9184	13	9383	705	9542	78	9676	40	9905	174	10167	1
9048	128	9186	13	9384	705	9543	78	9677	40	9916	183	10168	1
9049	128	9188	13	9385	705	9544	78	9679	40	9948	164	10169	1
9050	128	9191	13	9386	705	9545	78	9680	40	9965	691	10170	1
9051	128	9192	13	9387	705	9546	78	9681	40	9986	715	10171	1
9052	139	9193	13	9388	705	9547	78	9683	40	9992	715	10172	2
9055	139	9194	13	9389	705	9548	78	9684	40	9994	715	10173	2
9056	139	9199	13	9391	705	9555	8	9685	40	9999	715	10174	2
9057	139	9201	13	9399	14	9556	8	9686	40	10005	715	10175	2
9058	139	9203	13	9400	14	9557	8	9687	40	10006	715	10176	2
9059	139	9208	13	9401	14	9564	8	9688	40	10008	715	10177	2
9060	139	9210	13	9402	14	9565	8	9689	40	10009	715	10178	2
9064	139	9212	13	9403	14	9566	8	9690	40	10010	715	10179	2
9065	140	9219	13	9404	14	9568	8	9692	40	10011	715	10180	3
9069	466	9224	13	9405	14	9569	8	9694	40	10012	715	10181	3
9091	7	9229	27	9406	14	9570	8	9695	40	10013	715	10182	3
9100	7	9246	704	9407	14	9571	8	9696	40	10014	715	10183	3
9110	125	9247	704	9408	14	9572	8	9697	40	10018	715	10184	333
9112	125	9248	704	9409	14	9575	8	9699	40	10036	81	10186	333
9114	125	9249	704	9410	14	9576	8	9701	40	10048	106	10191	333
9115	218	9250	704	9411	14	9577	8	9702	40	10050	106	10192	333
9118	13	9251	704	9412	14	9578	8	9705	40	10051	106	10197	333
9119	13	9252	704	9416	359	9581	8	9709	40	10052	107	10198	333
9120	13	9257	228	9417	359	9582	8	9711	40	10053	106	10217	221
9121	13	9258	228	9433	127	9584	702	9712	40	10054	107	10218	221
9122	13	9259	228	9435	127	9585	702	9715	40	10055	107	10220	471
9124	13	9260	228	9436	127	9586	702	9727	40	10057	216	10221	702
9125	13	9261	228	9438	127	9587	702	9728	40	10058	216	10222	199
9126	13	9262	229	9440	127	9588	702	9729	40	10059	216	10223	199
9127	13	9264	229	9441	127	9589	702	9731	40	10064	104	10231	129
9128	13	9265	229	9443	127	9590	702	9732	40	10065	104	10232	129
9129	13	9266	229	9444	127	9591	702	9739	40	10066	104	10242	347
9130	13	9267	229	9446	127	9592	702	9744	40	10067	104	10243	348
9131	13	9275	347	9447	127	9593	702	9745	40	10068	19	10262	548
9132	13	9278	232	9469	501	9594	702	9748	40	10073	100	10264	91
9133	13	9279	232	9477	483	9595	702	9749	347	10080	548	10265	91
9134	13	9282	232	9480	21	9596	702	9756	22	10084	21	10266	91
9135	13	9283	232	9481	150	9597	702	9757	21	10085	82	10267	91
9136	13	9284	232	9482	10	9598	702	9759	130	10086	82	10268	91
9137	13	9285	232	9483	10	9599	702	9763	130	10087	82	10269	91
9138	13	9288	129	9484	10	9600	702	9774	130	10090	464	10270	91
9139	13	9289	129	9485	10	9601	702	9794	130	10101	134	10271	91
9140	13	9290	129	9486	10	9603	36	9795	130	10102	134	10272	91
9141	13	9291	129	9487	10	9604	6	9796	130	10103	134	10273	91

NUMERICAL INDEX

Auveco No.	Page	Auveco No.	Page	Auveco No.	Page	Auveco No.	Page	Auveco No.	Page	Auveco No.	Page	Auveco No.	Page
10274	91	10488	43	10581	71	10783	199	11129	365	11326	88	11506	118
10275	91	10497	43	10582	71	10788	128	11130	377	11327	88	11507	118
10276	91	10498	43	10583	71	10789	128	11136	382	11328	88	11508	118
10277	91	10501	43	10584	71	10790	128	11138	470	11331	88	11509	118
10278	91	10502	43	10585	71	10791	128	11146	371	11332	88	11512	119
10279	91	10504	43	10586	71	10792	128	11152	348	11345	348	11513	119
10280	91	10505	43	10587	71	10793	128	11154	175	11347	368	11514	119
10282	91	10506	43	10588	71	10808	164	11156	175	11349	400	11515	119
10283	91	10507	43	10589	71	10823	21	11157	175	11350	376	11516	119
10284	91	10508	43	10590	71	10830	106	11166	174	11351	373	11517	119
10285	91	10509	43	10591	71	10831	371	11179	83	11352	498	11518	119
10286	91	10510	43	10592	71	10832	371	11180	83	11354	539	11519	119
10288	91	10511	43	10593	71	10837	529	11181	83	11360	164	11520	119
10289	91	10512	43	10595	71	10843	346	11182	83	11361	164	11521	119
10290	91	10513	43	10596	71	10845	46	11183	83	11362	164	11523	119
10296	8	10514	43	10598	705	10846	46	11184	83	11363	164	11527	119
10305	466	10515	43	10599	705	10848	46	11187	115	11364	164	11602	144
10318	472	10516	43	10600	705	10851	46	11212	135	11365	164	11604	144
10319	150	10517	43	10601	705	10853	46	11220	135	11366	164	11605	142
10322	682	10519	43	10602	705	10854	46	11224	135	11367	164	11606	142
10330	465	10520	43	10603	705	10855	46	11226	135	11368	39	11612	366
10332	373	10521	43	10604	705	10858	46	11228	134	11369	36	11614	18
10336	247	10522	43	10605	705	10859	46	11229	134	11370	37	11615	18
10337	247	10523	44	10606	705	10861	46	11243	462	11371	535	11618	169
10345	247	10524	44	10607	705	10863	46	11244	462	11392	164	11620	251
10346	247	10525	44	10608	704	10864	46	11245	462	11404	41	11621	252
10348	247	10526	44	10609	704	10865	46	11246	462	11405	143	11625	107
10349	247	10527	44	10610	704	10866	46	11253	464	11406	357	11626	107
10350	247	10528	44	10611	704	10868	46	11255	45	11419	133	11627	109
10351	247	10529	44	10612	704	10870	46	11256	45	11424	466	11628	109
10352	247	10530	44	10613	704	10872	46	11257	45	11425	471	11629	109
10354	247	10532	44	10614	704	10873	46	11258	45	11429	102	11630	109
10355	247	10534	44	10615	704	10875	46	11259	45	11434	199	11631	109
10356	247	10535	44	10617	471	10878	46	11262	45	11435	199	11633	52
10357	247	10536	44	10621	401	10885	46	11263	45	11436	182	11638	53
10358	247	10537	44	10622	349	10898	46	11264	45	11437	194	11639	53
10359	247	10538	44	10630	348	10960	46	11265	45	11438	196	11640	53
10362	21	10539	44	10631	348	10961	46	11266	45	11439	198	11641	54
10364	32	10540	44	10632	361	10970	46	11267	45	11440	182	11644	65
10365	468	10541	44	10642	26	10972	46	11268	45	11441	174	11645	65
10368	135	10542	44	10643	722	11006	47	11269	45	11442	182	11653	535
10374	82	10543	44	10644	722	11022	47	11270	45	11443	182	11654	535
10375	82	10544	44	10649	219	11024	47	11271	45	11444	181	11655	463
10378	160	10545	44	10652	4	11032	47	11273	45	11445	193	11656	463
10379	160	10546	44	10653	4	11049	63	11274	45	11446	175	11657	463
10380	160	10547	44	10654	4	11051	63	11275	45	11448	4	11660	512
10381	160	10548	44	10655	18	11053	63	11276	45	11449	4	11661	512
10382	160	10549	44	10656	18	11055	63	11277	63	11450	4	11665	463
10384	160	10550	44	10657	18	11057	63	11278	63	11451	4	11667	463
10385	150	10551	44	10658	253	11059	63	11279	63	11452	4	11671	390
10386	150	10553	74	10666	102	11061	22	11280	63	11453	4	11672	401
10390	125	10554	74	10697	134	11066	347	11288	471	11454	4	11673	373
10391	126	10556	74	10701	348	11067	347	11292	102	11455	4	11675	367
10392	126	10557	74	10714	32	11083	166	11293	100	11456	4	11677	402
10393	126	10558	74	10719	144	11084	1	11294	5	11457	4	11678	401
10394	126	10559	74	10720	144	11086	1	11295	5	11467	166	11679	367
10395	126	10560	74	10724	148	11087	1	11296	5	11470	463	11680	366
10396	126	10562	74	10729	88	11088	1	11297	5	11475	176	11691	466
10397	126	10563	74	10730	88	11089	1	11298	341	11476	175	11697	551
10398	126	10564	74	10731	88	11090	1	11299	341	11485	470	11699	487
10427	42	10566	74	10732	88	11091	1	11308	466	11486	117	11702	414
10431	42	10567	74	10733	83	11092	1	11310	89	11488	117	11704	542
10436	42	10568	74	10737	128	11097	230	11311	89	11489	117	11705	524
10437	42	10569	63	10738	128	11098	230	11312	89	11490	117	11706	524
10438	42	10570	63	10739	128	11099	230	11313	89	11491	117	11708	64
10439	42	10571	63	10740	128	11100	230	11314	89	11492	117	11709	64
10440	42	10572	63	10741	128	11101	230	11315	89	11493	117	11717	471
10441	42	10573	63	10742	128	11104	253	11316	89	11494	117	11718	463
10459	42	10574	63	10744	379	11105	253	11317	89	11495	117	11719	39
10460	42	10575	63	10759	463	11106	253	11318	89	11500	118	11721	366
10464	42	10576	63	10760	535	11109	22	11319	89	11501	118	11729	166
10466	42	10577	71	10764	82	11110	22	11320	22	11502	118	11733	127
10476	42	10578	71	10773	81	11118	482	11321	135	11503	118	11736	127
10478	43	10579	71	10780	357	11119	362	11324	88	11504	118	11738	132
10480	43	10580	71	10782	199	11120	365	11325	88	11505	118	11740	78

NUMERICAL INDEX

Auveco No.	Page	Auveco No.	Page	Auveco No.	Page	Auveco No.	Page	Auveco No.	Page	Auveco No.	Page	Auveco No.	Page
11741	78	11888	74	12038	695	12161	150	12348	53	12487	694	12653	251
11742	78	11895	74	12039	697	12162	139	12350	61	12488	694	12654	260
11743	78	11896	74	12040	697	12163	139	12351	61	12491	695	12655	252
11744	78	11899	74	12041	697	12164	139	12354	61	12492	695	12656	254
11746	129	11904	6	12042	697	12165	142	12359	169	12517	11	12657	259
11747	129	11905	6	12044	697	12169	716	12361	221	12518	11	12658	252
11748	129	11906	6	12045	697	12171	716	12363	169	12519	11	12666	108
11749	129	11908	6	12047	696	12172	716	12365	5	12520	86	12667	109
11761	728	11909	6	12049	696	12173	716	12367	5	12521	86	12669	108
11762	728	11910	6	12050	696	12177	716	12368	5	12522	86	12671	359
11768	102	11911	6	12057	61	12184	716	12369	5	12523	86	12675	85
11770	19	11912	6	12059	58	12185	716	12370	5	12524	86	12676	262
11771	19	11913	6	12060	29	12187	716	12374	93	12525	86	12682	700
11774	401	11914	6	12061	27	12192	716	12375	93	12526	728	12683	700
11775	230	11915	6	12062	58	12209	341	12376	93	12528	239	12684	700
11776	230	11916	6	12064	51	12210	341	12377	93	12529	239	12685	700
11777	230	11917	3	12065	52	12213	4	12378	93	12534	172	12686	700
11778	230	11918	3	12066	52	12214	4	12379	93	12535	172	12688	700
11779	230	11919	3	12067	51	12215	4	12380	93	12536	172	12689	700
11780	230	11920	3	12068	61	12216	4	12381	93	12537	172	12693	51
11782	227	11921	3	12069	359	12217	4	12382	93	12538	172	12695	85
11783	227	11922	3	12076	213	12218	4	12383	93	12539	172	12697	78
11784	4	11923	3	12077	213	12228	512	12384	93	12540	172	12698	78
11785	4	11924	3	12078	213	12232	51	12385	93	12541	172	12699	78
11786	4	11925	112	12079	169	12233	214	12386	94	12542	172	12700	78
11787	4	11926	112	12080	249	12234	214	12387	94	12543	172	12701	78
11788	4	11927	112	12081	249	12235	214	12389	94	12544	172	12703	78
11789	4	11928	112	12083	249	12236	214	12390	94	12545	172	12704	78
11790	4	11929	112	12084	249	12237	174	12391	94	12546	172	12705	78
11791	4	11931	112	12085	249	12253	66	12392	94	12547	172	12706	78
11792	4	11933	112	12086	249	12254	66	12394	95	12548	172	12707	78
11795	359	11935	53	12088	249	12255	66	12395	95	12549	172	12708	78
11796	401	11936	539	12089	249	12256	66	12396	95	12550	172	12709	78
11797	391	11948	153	12091	249	12259	66	12397	95	12551	172	12710	78
11805	92	11949	728	12092	249	12260	66	12399	95	12552	172	12711	78
11806	92	11950	728	12093	249	12265	106	12400	95	12553	172	12713	468
11807	92	11953	221	12094	249	12268	694	12404	95	12554	172	12715	85
11808	92	11954	221	12095	27	12269	694	12405	95	12555	172	12722	78
11809	92	11955	221	12097	59	12270	694	12406	95	12556	172	12723	78
11810	92	11956	221	12099	3	12271	694	12407	95	12563	471	12728	497
11811	92	11957	221	12103	728	12272	694	12419	162	12565	389	12729	497
11812	92	11958	221	12104	728	12273	694	12420	162	12566	468	12731	373
11813	92	11961	221	12105	728	12274	694	12421	162	12567	487	12735	466
11814	92	11963	221	12110	65	12276	694	12422	162	12568	497	12737	401
11815	92	11973	41	12115	66	12277	694	12423	162	12569	514	12738	59
11816	471	11974	41	12116	66	12278	694	12424	162	12571	373	12739	58
11817	242	11980	41	12117	66	12279	694	12425	162	12575	108	12740	58
11826	463	11981	41	12118	66	12280	694	12426	162	12576	577	12741	59
11827	142	11982	41	12119	66	12281	694	12427	162	12580	582	12742	59
11828	142	11983	41	12122	66	12283	695	12428	162	12583	638	12756	488
11829	142	11984	41	12123	66	12284	695	12429	162	12585	638	12757	487
11830	142	11987	41	12124	66	12285	695	12430	162	12589	616	12759	375
11831	498	11989	41	12125	66	12286	695	12431	162	12591	617	12766	374
11836	467	11990	41	12126	66	12288	695	12432	162	12592	169	12771	111
11838	465	11991	41	12127	66	12289	695	12433	162	12594	472	12772	111
11841	515	11993	41	12129	40	12290	695	12434	162	12595	64	12773	111
11842	376	11995	41	12134	358	12292	695	12435	162	12596	64	12774	111
11852	251	11998	41	12135	348	12293	695	12436	162	12598	195	12775	111
11853	242	12009	22	12137	374	12295	695	12437	162	12599	195	12776	111
11854	486	12021	694	12144	140	12300	696	12439	162	12600	176	12777	111
11855	466	12022	694	12146	144	12303	696	12440	162	12602	472	12778	111
11863	357	12023	694	12147	139	12305	696	12441	162	12605	463	12779	111
11864	108	12024	694	12148	139	12307	696	12442	162	12606	530	12781	111
11865	467	12025	694	12149	139	12314	510	12443	162	12617	85	12782	111
11871	464	12026	694	12150	139	12315	510	12444	162	12621	472	12783	111
11872	126	12027	694	12151	139	12316	510	12445	162	12622	528	12784	111
11873	126	12028	694	12152	139	12322	51	12447	162	12627	163	12785	111
11874	126	12029	694	12153	139	12323	52	12448	162	12628	163	12786	111
11876	74	12030	695	12154	142	12324	51	12470	534	12629	163	12787	111
11877	74	12031	695	12155	142	12327	54	12472	728	12630	148	12788	111
11878	74	12032	695	12156	142	12335	52	12474	728	12631	148	12789	111
11879	74	12034	695	12157	142	12336	53	12475	728	12635	682	12790	111
11881	74	12035	695	12158	143	12338	52	12477	728	12637	689	12791	150
11884	74	12036	695	12159	142	12339	61	12485	694	12642	650	12792	150
11886	74	12037	695	12160	51	12343	53	12486	694	12652	261	12794	538

NUMERICAL INDEX

Auveco No.	Page	Auveco No.	Page	Auveco No.	Page	Auveco No.	Page	Auveco No.	Page	Auveco No.	Page	Auveco No.	Page
127951	129504	13057262	1326416	1335515	13520215	13665145
127961	129514	13058262	1326514	1335615	13521215	13666145
127971	129524	13059262	1326614	1335715	13522215	13669145
127981	129534	13060262	1326714	1335915	13523214	13670145
127993	129544	13061262	1326814	1336015	13524214	13671145
128003	129554	13062262	1326914	1336115	13528214	13672145
128012	129564	13063262	1327014	1336215	13529214	13673145
128022	129574	13064262	1327114	1336315	13530214	13674145
128032	12958692	13065262	1327214	1336415	13531214	13675145
128052	12959691	13072262	1327314	1336515	13533184	13676145
128062	12960692	13095262	1327414	1336615	13535184	13677145
128072	12961692	13120262	1327514	1336715	13537184	13678145
128092	12962691	13121262	1327614	1336815	13540174	13679145
128112	12966691	13124262	1327714	1337015	13541195	13680145
128184	12971691	13128262	1327814	1337315	13542195	13681145
128204	12975164	13132262	1327914	1337415	13543176	13682145
128214	12977169	13133262	1328014	1337515	13544175	13683147
12824472	1297889	13134262	1328114	1337715	13545176	13684147
12831715	1297989	13136262	1328214	1337915	13546176	13685147
12832715	1298089	13141627	1328314	1339115	13547182	13686170
12833716	1298189	13144627	1328414	1339216	13548182	1368728
12851715	1298289	1315067	1328614	1339316	13549174	13691114
12852715	1298389	13157627	1328814	1339416	13552213	13692114
12858715	1298489	13158574	1328914	1339516	13554197	13693114
12859715	1298589	1316268	1329014	1339616	13555213	13694114
12860715	1298689	13167575	1329114	1339716	13556214	13695114
12861715	1298789	1317067	1329214	1339816	13558174	13696114
12862715	1298892	13172574	1329314	1340116	13559198	13697114
12870715	1298992	13173684	1329414	1340216	13564349	13698114
12875715	1299092	13174682	1329814	1340316	13572726	13699114
12890715	1299192	13179400	1329914	1340416	13574723	13701114
128931	12992402	13189682	1330014	1340516	13575724	1370453
128941	12993366	13191690	1330114	1340616	13577736	1370553
128951	1299597	13195689	1330214	1340915	13578725	1370726
128961	1299697	13198368	1330414	1341015	13579726	1370827
128971	1299797	13206685	1330514	1341115	13580697	1370930
128992	1299897	13207650	1330614	1341215	13581699	1371128
129002	1299997	1321568	1330814	1341315	13582699	1371258
129023	1300299	1321668	1331014	1341415	13584699	1371551
129033	1300399	1321868	1331114	1341515	13587699	13717110
129043	1300499	1322069	1331214	1341715	13590697	13718110
129053	1300599	1322167	1331414	1342015	13599698	13719110
12907341	1300699	1322367	1331614	1342115	13600698	13720110
12908341	1300799	1322467	1332214	1342215	13601698	13721110
12909375	1300899	1322568	1332314	1342415	13610697	13723110
12916132	1300999	1322767	1332414	1342615	1361353	13724110
12917132	1301099	13229682	1332514	1342915	1361453	13725110
12918132	1301199	13230628	1332614	1343015	13616538	137275
12919132	1301297	1323121	1332714	1343415	1361751	137285
12920132	1301497	1323221	1332814	13445171	1361852	137365
12921132	1301697	13233195	1332914	13446171	1361954	13746245
12922132	1301797	1323416	1333014	13447171	1362054	13747245
12923132	1301961	1323516	1333114	13449171	13625725	13748245
12924132	1302131	1323616	1333214	13450465	13626725	13749245
12925132	1302527	1323716	1333314	13453401	13628167	13750246
12926132	1302628	1323916	1333414	13454368	13629213	13751246
12927133	1302730	1324016	1333514	13456495	13630213	13752246
12929131	13030534	1324116	1333614	13457484	13631213	13753246
12930131	13031689	1324216	1333714	13458472	13632213	13754245
12931131	13039262	1324316	1333814	13461401	13634200	13755245
12932133	13040262	1324416	1333914	13464650	13636200	13756243
12933133	13041262	1324516	1334014	13465547	13639200	13757379
12934132	13042262	1324616	1334114	1346638	13640200	13766248
12935131	13043262	1324816	1334214	13467379	13643200	13767248
12936131	13044262	1324916	1334314	13469524	13644194	13768248
12937131	13045262	1325016	1334414	13470389	13647536	13769248
12938132	13046262	1325116	1334514	13472530	13656145	13770248
12939133	13047262	1325216	1334615	13475400	13657145	13773249
12940133	13049262	1325316	1334715	1347689	13658145	13774249
12943133	13051262	1325616	1334815	1347789	13659145	13782248
12944133	13052262	1325816	1334915	1348089	13660145	13796248
12946132	13053262	1326016	1335015	1348189	13661145	13805247
12947133	13054262	1326116	1335215	1349489	13662145	13807247
12948133	13055262	1326216	1335315	1349589	13663145	13808242
12949133	13056262	1326316	1335415	13514214	13664145	13810166

NUMERICAL INDEX

Auveco No.	Page	Auveco No.	Page	Auveco No.	Page	Auveco No.	Page	Auveco No.	Page	Auveco No.	Page	Auveco No.	Page
13811	166	13930	639	14104	124	14268	665	14410	43	14531	217	14723	385
13814	166	13931	639	14113	123	14269	395	14411	43	14532	217	14724	640
13816	166	13932	663	14127	258	14270	396	14412	43	14533	217	14725	647
13828	472	13933	466	14128	185	14271	663	14413	43	14541	720	14726	645
13831	2	13934	37	14130	185	14273	667	14414	43	14543	725	14727	648
13832	2	13935	38	14131	185	14274	664	14415	43	14544	496	14728	395
13833	2	13937	216	14132	185	14275	665	14417	43	14545	496	14731	662
13834	2	13939	216	14133	184	14276	681	14418	43	14546	496	14732	679
13835	2	13941	216	14135	185	14277	664	14419	43	14547	496	14736	383
13836	2	13944	216	14144	396	14278	662	14420	43	14548	509	14737	383
13837	2	13945	400	14145	466	14280	586	14421	44	14549	509	14738	385
13838	2	13946	402	14147	492	14281	587	14422	44	14550	509	14739	664
13839	2	13960	466	14150	151	14282	383	14423	44	14551	533	14745	662
13840	2	13964	100	14151	151	14284	680	14424	44	14552	550	14746	662
13841	2	13965	100	14152	151	14287	586	14425	44	14553	509	14747	663
13842	2	13966	100	14153	151	14288	585	14426	44	14559	508	14749	663
13843	538	13967	339	14154	151	14289	366	14427	44	14561	550	14750	680
13845	539	13992	401	14155	243	14290	593	14428	44	14568	221	14751	662
13847	539	13993	489	14156	98	14291	383	14429	44	14575	725	14753	485
13850	164	13994	492	14157	98	14293	593	14430	44	14576	725	14754	514
13851	164	13996	489	14158	98	14294	586	14431	44	14577	243	14755	513
13856	495	13999	488	14159	98	14296	586	14432	44	14580	179	14756	513
13858	497	14001	484	14160	98	14298	598	14433	44	14581	43	14757	368
13860	495	14002	465	14161	98	14299	379	14434	44	14582	43	14758	402
13863	129	14004	245	14162	98	14306	578	14435	44	14583	43	14764	332
13864	129	14005	245	14163	378	14308	578	14436	44	14584	43	14765	332
13865	129	14006	365	14170	719	14313	586	14437	44	14585	43	14769	733
13866	129	14007	487	14171	719	14317	585	14438	44	14586	43	14770	733
13867	129	14008	483	14172	719	14319	386	14439	44	14587	43	14773	284
13869	129	14009	468	14173	719	14323	386	14440	44	14588	43	14774	284
13871	129	14010	487	14174	719	14328	379	14441	44	14589	44	14775	284
13872	129	14011	487	14178	719	14331	639	14442	44	14590	44	14777	45
13873	129	14012	246	14185	65	14333	638	14443	44	14591	44	14778	45
13875	129	14013	483	14194	689	14334	639	14444	44	14592	44	14779	45
13876	129	14014	466	14196	223	14335	640	14445	44	14595	44	14780	45
13877	129	14016	488	14197	162	14337	648	14446	44	14598	44	14781	45
13878	129	14017	366	14198	162	14345	648	14447	44	14602	44	14782	45
13879	129	14018	526	14199	162	14346	648	14448	63	14604	45	14784	45
13880	129	14019	526	14200	162	14347	386	14449	63	14605	45	14787	45
13881	129	14020	526	14201	162	14348	384	14450	63	14606	45	14788	45
13883	129	14021	365	14202	162	14349	383	14451	63	14607	45	14789	45
13885	129	14023	245	14203	162	14352	383	14452	63	14608	45	14790	45
13887	129	14030	466	14204	162	14353	386	14453	63	14610	45	14791	45
13888	114	14031	466	14205	720	14355	382	14454	63	14611	45	14792	45
13891	114	14032	370	14206	720	14356	386	14455	63	14612	45	14793	45
13892	114	14033	472	14207	720	14357	618	14456	63	14613	45	14794	45
13893	114	14035	370	14208	720	14359	624	14457	63	14616	45	14795	45
13894	114	14036	370	14209	690	14363	400	14458	63	14617	45	14796	63
13895	114	14037	468	14210	690	14364	618	14459	63	14625	63	14797	63
13896	114	14046	2	14211	689	14365	624	14461	722	14626	63	14799	242
13897	114	14048	57	14212	690	14366	618	14462	152	14629	63	14801	137
13898	114	14053	57	14213	518	14367	365	14473	35	14632	71	14802	137
13899	114	14055	169	14215	471	14369	434	14474	173	14633	71	14803	137
13900	114	14059	124	14217	497	14376	624	14486	252	14634	71	14804	137
13902	114	14060	124	14218	536	14378	624	14487	11	14636	71	14805	137
13903	114	14063	124	14220	468	14380	386	14489	11	14637	71	14806	137
13904	114	14064	124	14225	84	14388	215	14490	11	14642	472	14807	137
13905	114	14065	124	14227	84	14389	167	14491	11	14677	224	14808	137
13906	114	14066	124	14228	84	14391	42	14493	11	14678	225	14813	134
13907	114	14067	124	14231	84	14392	42	14494	11	14685	582	14814	102
13908	114	14068	124	14235	84	14393	42	14495	11	14687	597	14819	530
13909	114	14070	124	14237	84	14394	42	14496	11	14688	597	14820	500
13910	114	14072	124	14241	84	14395	42	14497	11	14690	586	14821	465
13911	114	14074	124	14243	84	14396	42	14498	11	14695	587	14822	102
13912	114	14089	125	14244	84	14398	42	14499	11	14696	595	14824	40
13913	114	14094	125	14253	85	14400	43	14500	11	14697	595	14827	40
13914	114	14095	125	14255	585	14401	43	14501	11	14698	596	14830	363
13916	114	14096	125	14256	663	14402	43	14521	64	14700	584	14833	363
13918	114	14097	124	14258	664	14403	43	14522	64	14701	582	14834	363
13919	114	14098	124	14260	676	14404	43	14523	64	14703	584	14835	364
13920	114	14099	124	14263	665	14405	43	14524	401	14705	584	14836	221
13921	114	14100	124	14264	659	14406	43	14526	104	14709	367	14837	221
13922	37	14101	124	14265	665	14407	43	14527	104	14719	616	14838	221
13924	470	14102	124	14266	667	14408	43	14529	217	14720	386	14839	221
13925	469	14103	124	14267	667	14409	43	14530	217	14721	624	14840	221

NUMERICAL INDEX

Auveco No.	Page	Auveco No.	Page	Auveco No.	Page	Auveco No.	Page	Auveco No.	Page	Auveco No.	Page	Auveco No.	Page
14847	112	14977	21	15103	228	15204	160	15413	37	15543	372	15721	59
14848	112	14980	66	15104	228	15205	160	15414	371	15544	92	15748	731
14850	112	14985	379	15106	228	15206	160	15415	228	15545	18	15752	104
14851	112	14987	485	15107	228	15207	160	15416	228	15586	79	15753	221
14852	112	14988	522	15108	228	15208	160	15417	228	15587	79	15754	221
14853	112	14990	485	15109	228	15209	160	15418	228	15588	79	15758	35
14854	112	14991	485	15110	229	15212	721	15420	229	15589	79	15759	503
14855	65	14992	522	15111	229	15239	162	15422	229	15590	79	15764	330
14856	65	14993	486	15114	229	15240	162	15423	229	15591	79	15765	330
14857	366	14994	524	15115	229	15256	162	15424	229	15592	79	15766	330
14858	547	14995	485	15116	229	15257	162	15426	230	15594	79	15767	330
14859	4	14997	485	15117	229	15258	162	15431	230	15595	79	15768	330
14860	4	14998	486	15118	229	15259	162	15434	230	15596	79	15769	330
14861	4	15000	228	15119	229	15260	162	15436	230	15597	79	15770	330
14862	4	15003	86	15120	229	15263	162	15438	228	15598	79	15771	330
14866	71	15004	86	15121	229	15301	724	15439	228	15599	79	15772	330
14867	71	15009	86	15122	230	15310	62	15440	228	15600	79	15773	330
14868	71	15010	86	15123	230	15316	64	15441	228	15601	79	15774	27
14869	71	15011	86	15124	230	15317	64	15444	229	15603	165	15775	60
14870	71	15015	86	15125	230	15318	64	15446	229	15605	165	15776	60
14871	71	15017	87	15126	230	15325	64	15450	228	15606	165	15778	51
14873	81	15018	87	15127	230	15326	64	15453	340	15607	165	15779	52
14874	81	15035	158	15128	230	15327	64	15456	377	15608	165	15780	53
14875	81	15037	27	15129	230	15328	64	15457	377	15609	165	15783	22
14876	81	15039	167	15130	230	15329	64	15459	501	15610	165	15788	52
14877	81	15040	369	15131	230	15330	64	15461	401	15611	165	15790	53
14878	81	15042	493	15132	230	15331	64	15462	350	15618	165	15791	51
14879	112	15043	492	15133	230	15332	64	15463	350	15619	165	15792	21
14880	154	15044	493	15134	230	15333	64	15464	351	15620	165	15793	714
14881	154	15045	493	15135	230	15334	64	15466	351	15621	165	15794	714
14883	153	15046	172	15136	230	15335	64	15467	351	15622	165	15795	714
14884	157	15047	172	15137	230	15337	64	15468	638	15624	165	15796	714
14885	157	15048	172	15138	230	15345	82	15469	638	15625	165	15798	714
14887	156	15049	172	15139	230	15347	82	15470	638	15628	165	15799	714
14888	156	15050	367	15140	230	15350	82	15472	584	15632	165	15800	714
14889	156	15054	228	15141	230	15351	82	15474	584	15634	512	15801	714
14892	157	15055	228	15142	230	15355	5	15475	661	15640	80	15803	714
14895	530	15056	228	15143	230	15356	5	15478	374	15641	80	15805	714
14896	150	15057	229	15144	221	15357	5	15479	375	15642	80	15807	48
14897	150	15058	229	15145	221	15358	5	15480	373	15643	80	15811	65
14898	150	15059	229	15146	221	15366	623	15481	373	15644	80	15813	347
14899	150	15060	229	15147	221	15367	367	15488	245	15645	80	15818	52
14901	127	15061	229	15148	221	15369	181	15490	246	15646	80	15821	30
14902	127	15062	229	15150	221	15372	163	15491	246	15649	80	15827	30
14903	127	15065	228	15151	221	15373	59	15497	154	15650	80	15849	160
14904	127	15066	229	15158	149	15374	9	15498	154	15651	80	15851	216
14905	127	15067	230	15159	149	15375	9	15499	154	15652	80	15854	216
14906	127	15068	228	15160	149	15376	9	15504	157	15653	80	15858	164
14907	127	15069	228	15161	149	15377	9	15505	172	15654	80	15860	703
14908	127	15071	228	15162	149	15378	9	15506	172	15664	371	15861	703
14909	127	15072	228	15163	149	15379	9	15507	172	15666	682	15862	703
14910	127	15073	228	15164	149	15380	9	15508	172	15668	377	15863	78
14911	127	15074	228	15165	149	15381	9	15509	172	15669	401	15864	78
14912	127	15075	228	15166	149	15382	9	15512	43	15670	402	15865	78
14913	728	15076	228	15167	149	15383	9	15514	43	15672	542	15867	42
14916	728	15077	228	15168	149	15385	9	15515	44	15673	548	15868	42
14918	177	15078	229	15170	36	15386	9	15516	44	15674	548	15869	42
14920	150	15079	229	15171	27	15387	9	15517	44	15675	532	15870	42
14921	365	15080	229	15172	27	15388	9	15518	503	15676	465	15871	42
14923	129	15082	229	15180	11	15389	9	15522	524	15677	106	15872	42
14926	720	15083	229	15187	245	15390	9	15523	373	15684	251	15873	42
14927	720	15084	229	15188	221	15391	9	15525	704	15687	363	15874	42
14946	471	15085	229	15189	221	15392	9	15526	704	15688	232	15875	42
14947	52	15086	229	15190	221	15393	9	15527	223	15689	232	15876	42
14952	57	15087	229	15191	221	15394	9	15528	226	15691	735	15877	42
14953	522	15088	229	15192	221	15395	9	15529	226	15692	735	15878	42
14963	543	15089	229	15194	221	15396	9	15530	226	15694	231	15879	42
14967	548	15094	228	15195	221	15397	9	15531	284	15695	657	15880	42
14968	498	15096	229	15196	221	15398	9	15532	284	15701	526	15881	42
14970	4	15097	229	15197	221	15399	9	15533	284	15702	493	15882	42
14972	4	15098	230	15198	221	15400	9	15538	137	15705	160	15890	42
14973	4	15099	230	15199	221	15401	9	15539	137	15706	160	15892	42
14974	166	15100	228	15200	221	15402	9	15540	137	15707	396	15893	42
14975	166	15101	228	15202	221	15403	9	15541	137	15709	396	15895	42
14976	21	15102	228	15203	221	15404	9	15542	137	15711	66	15896	42

NUMERICAL INDEX

Auveco No.	Page	Auveco No.	Page	Auveco No.	Page	Auveco No.	Page	Auveco No.	Page	Auveco No.	Page	Auveco No.	Page
15898	10	16021	112	16200	717	16360	172	16571	713	16706	44	16830	65
15902	10	16022	112	16202	717	16362	8	16574	713	16707	44	16832	340
15903	10	16023	112	16204	717	16363	8	16575	713	16708	44	16833	661
15905	10	16026	222	16205	717	16364	8	16578	167	16709	44	16834	255
15910	10	16031	240	16207	717	16365	8	16585	176	16710	44	16835	486
15911	112	16032	240	16213	461	16368	8	16586	176	16711	44	16837	251
15912	112	16033	6	16230	97	16369	8	16589	30	16712	44	16838	252
15913	112	16034	6	16236	99	16370	8	16592	360	16713	44	16842	108
15914	112	16035	6	16237	99	16371	8	16593	110	16714	44	16843	623
15915	112	16036	6	16240	99	16372	8	16596	58	16715	44	16846	108
15916	112	16037	6	16242	99	16375	8	16603	702	16716	44	16849	340
15917	112	16038	6	16244	99	16376	8	16604	702	16717	44	16850	340
15918	112	16039	6	16248	99	16377	8	16609	45	16718	44	16851	82
15919	112	16040	6	16251	99	16378	8	16610	45	16720	59	16852	82
15921	151	16041	6	16252	99	16379	8	16611	45	16721	111	16856	98
15922	151	16042	6	16253	99	16380	8	16612	45	16725	448	16858	646
15923	152	16043	6	16254	99	16381	8	16613	45	16726	525	16859	645
15924	153	16044	6	16255	99	16382	8	16614	45	16727	126	16860	637
15926	171	16045	136	16256	99	16383	8	16617	63	16729	549	16861	585
15927	171	16046	136	16259	371	16384	8	16622	490	16733	511	16863	377
15928	171	16049	136	16260	401	16385	8	16624	489	16736	1	16864	256
15929	171	16051	136	16261	401	16386	8	16625	491	16739	22	16865	483
15930	171	16052	136	16262	374	16387	8	16626	330	16743	122	16868	703
15931	171	16066	136	16263	374	16388	8	16629	330	16744	122	16869	703
15932	171	16067	136	16264	341	16389	8	16631	330	16745	122	16870	703
15933	171	16070	136	16265	487	16390	336	16632	330	16746	122	16871	703
15935	153	16071	136	16267	104	16391	336	16634	330	16747	122	16872	703
15937	151	16072	136	16268	64	16392	336	16635	330	16748	122	16873	703
15938	155	16087	717	16269	65	16393	336	16636	330	16751	47	16874	703
15939	155	16088	717	16275	735	16394	336	16638	330	16754	47	16875	703
15940	512	16089	717	16276	735	16395	336	16639	330	16755	47	16876	703
15941	58	16090	717	16277	735	16396	511	16640	330	16758	47	16877	703
15944	155	16091	717	16279	735	16397	512	16642	330	16760	47	16878	703
15945	155	16092	717	16280	735	16399	511	16643	330	16761	47	16879	703
15946	154	16093	717	16283	737	16407	9	16644	330	16762	47	16880	65
15947	154	16094	717	16285	737	16411	9	16645	330	16763	71	16883	64
15948	151	16095	717	16286	737	16412	9	16646	330	16764	71	16889	3
15949	152	16096	717	16288	737	16413	9	16647	330	16766	703	16890	336
15950	152	16097	717	16289	737	16416	9	16648	330	16767	703	16891	336
15951	152	16107	717	16293	737	16418	363	16649	330	16769	65	16892	336
15952	152	16108	717	16294	721	16419	363	16650	330	16770	82	16893	52
15953	152	16115	576	16296	721	16420	161	16654	135	16771	82	16894	735
15954	152	16124	67	16297	721	16421	35	16665	168	16773	82	16896	203
15955	151	16132	372	16299	721	16422	35	16666	168	16774	64	16897	203
15956	153	16134	66	16303	721	16425	513	16667	736	16775	371	16898	203
15957	153	16136	64	16306	680	16454	332	16669	38	16776	369	16899	201
15959	153	16142	67	16308	225	16455	332	16670	38	16777	385	16901	201
15960	153	16149	7	16322	108	16456	332	16671	680	16778	400	16902	201
15962	61	16152	7	16323	36	16457	332	16672	113	16779	386	16904	201
15966	511	16159	94	16324	331	16458	332	16673	113	16780	679	16905	201
15968	511	16161	94	16325	331	16470	65	16675	113	16781	384	16906	201
15969	511	16162	94	16326	331	16475	19	16676	113	16782	595	16907	201
15970	402	16163	95	16327	331	16478	27	16677	113	16783	645	16908	201
15973	241	16164	95	16328	331	16484	140	16680	222	16784	677	16909	201
15974	333	16168	734	16330	331	16485	140	16681	222	16785	89	16910	201
15975	333	16169	734	16331	331	16486	141	16682	222	16788	90	16911	201
15978	333	16174	177	16332	331	16487	139	16683	222	16789	90	16912	201
15979	333	16175	177	16334	331	16488	139	16684	222	16791	241	16913	201
15980	333	16177	90	16335	331	16489	139	16685	222	16792	241	16914	201
15984	340	16178	90	16336	331	16491	5	16686	255	16793	48	16915	201
15997	578	16179	90	16340	347	16506	712	16687	255	16794	48	16916	201
15998	376	16180	90	16341	92	16514	179	16690	38	16795	48	16917	201
16000	596	16182	90	16342	156	16524	337	16691	656	16796	48	16918	201
16001	221	16183	90	16344	156	16525	337	16693	178	16797	48	16919	201
16004	158	16184	90	16348	156	16527	167	16694	178	16800	38	16920	201
16009	110	16187	90	16349	156	16531	29	16695	392	16801	156	16921	201
16011	110	16188	90	16351	172	16534	29	16697	43	16804	156	16922	201
16012	110	16189	90	16352	172	16544	18	16698	43	16806	154	16923	201
16013	110	16190	90	16353	172	16555	615	16699	43	16816	488	16924	201
16015	110	16191	90	16354	172	16558	656	16700	43	16818	369	16925	201
16016	110	16192	90	16355	172	16564	717	16701	43	16821	663	16926	201
16017	401	16193	90	16356	172	16565	717	16702	43	16825	585	16927	201
16018	112	16194	90	16357	172	16567	717	16703	43	16826	36	16930	4
16019	112	16195	90	16358	172	16568	717	16704	44	16828	61	16931	53
16020	112	16198	717	16359	172	16570	713	16705	44	16829	66	16934	126

NUMERICAL INDEX

Auveco No.	Page	Auveco No.	Page	Auveco No.	Page	Auveco No.	Page	Auveco No.	Page	Auveco No.	Page	Auveco No.	Page
16936	510	17049	141	17191	48	17359	325	17470	254	17579	11	17990	384
16937	510	17050	142	17192	594	17360	150	17471	248	17580	11	17991	382
16938	391	17051	142	17193	649	17361	704	17472	647	17582	11	17992	613
16939	260	17052	142	17194	657	17362	704	17475	584	17583	11	17993	615
16940	259	17053	142	17195	632	17363	704	17478	622	17584	11	17994	201
16941	496	17057	596	17196	641	17364	704	17481	658	17586	99	17995	201
16942	663	17058	586	17198	180	17366	704	17485	661	17588	705	17996	201
16949	597	17060	623	17199	180	17367	704	17488	585	17589	705	17997	201
16950	597	17064	539	17205	385	17368	704	17490	148	17596	41	17998	201
16951	656	17068	535	17206	676	17378	647	17491	148	17597	201	17999	201
16953	495	17069	502	17207	129	17379	596	17492	148	17598	189	18000	201
16954	529	17072	379	17208	129	17381	376	17493	144	17599	403	18001	201
16955	222	17073	352	17214	485	17382	500	17494	144	17602	521	18002	201
16956	222	17075	391	17215	377	17383	486	17495	65	17604	331	18003	201
16959	352	17076	372	17216	491	17385	649	17496	246	17605	331	18004	201
16960	36	17080	543	17218	389	17387	48	17498	242	17606	331	18005	201
16961	134	17081	596	17219	472	17388	48	17499	13	17607	331	18006	201
16962	180	17084	81	17220	245	17389	48	17508	500	17608	570	18007	201
16964	180	17085	138	17222	488	17390	48	17509	344	17609	586	18008	201
16965	180	17086	702	17224	663	17391	63	17510	344	17611	679	18009	201
16966	198	17087	705	17226	488	17392	63	17513	344	17612	371	18010	201
16967	177	17088	726	17227	486	17393	71	17514	344	17615	254	18011	201
16968	180	17089	581	17228	37	17394	71	17515	93	17616	493	18012	201
16969	163	17091	37	17230	467	17395	71	17516	93	17617	190	18013	201
16970	163	17092	402	17233	483	17396	71	17517	93	17618	190	18014	201
16971	163	17093	730	17237	378	17397	71	17518	93	17619	190	18015	201
16972	163	17094	112	17238	94	17398	71	17519	93	17620	189	18016	201
16973	163	17095	112	17239	94	17399	44	17520	93	17621	191	18017	201
16974	163	17096	581	17240	94	17400	44	17521	93	17622	191	18018	201
16975	163	17098	35	17241	94	17401	44	17522	93	17623	187	18019	222
16976	163	17101	246	17242	94	17403	44	17523	93	17624	186	18020	222
16977	163	17102	390	17243	94	17404	44	17524	93	17625	172	18021	222
16978	90	17103	488	17244	94	17405	44	17525	93	17626	172	18022	223
16980	66	17104	542	17245	94	17408	253	17526	93	17627	172	18023	224
16981	79	17106	488	17246	94	17410	257	17527	93	17628	222	18024	225
16983	80	17107	179	17247	94	17411	250	17528	93	17629	132	18025	225
16985	18	17108	174	17248	94	17415	250	17529	93	17631	679	18026	226
16986	62	17109	179	17249	94	17416	250	17530	93	17632	523	18027	226
16988	247	17110	178	17261	222	17419	250	17531	93	17633	642	18028	245
16989	247	17111	178	17262	222	17420	250	17532	93	17634	366	18029	541
16990	247	17112	177	17263	222	17421	250	17533	94	17636	38	18030	489
16996	222	17113	179	17264	222	17422	250	17535	94	17639	261	18031	245
16997	26	17114	177	17265	222	17423	250	17536	94	17640	261	18032	541
17000	462	17115	157	17267	573	17424	250	17537	94	17641	258	18033	381
17002	153	17118	531	17270	580	17425	250	17538	94	17642	528	18034	536
17003	625	17119	531	17271	467	17427	250	17539	94	17643	528	18102	529
17004	378	17121	257	17280	584	17428	250	17540	94	17646	575	18103	169
17006	256	17122	532	17281	584	17429	250	17541	94	17649	402	18105	499
17010	65	17123	736	17282	584	17432	247	17542	94	17650	28	18108	245
17013	88	17124	389	17287	595	17433	247	17545	470	17654	247	18109	232
17017	114	17128	469	17289	598	17434	550	17551	516	17655	247	18110	232
17018	114	17143	597	17290	616	17436	509	17552	516	17659	193	18111	232
17019	114	17144	596	17298	662	17437	509	17553	517	17661	188	18113	639
17020	114	17145	227	17315	35	17438	657	17554	517	17662	191	18114	385
17021	114	17146	227	17316	35	17439	613	17555	230	17664	371	18115	588
17022	114	17147	227	17317	516	17440	567	17558	35	17666	482	18118	471
17023	114	17148	227	17320	581	17442	580	17559	41	17667	517	18119	597
17024	114	17151	539	17323	568	17443	578	17560	41	17669	397	18121	227
17028	13	17152	35	17330	662	17450	623	17561	11	17683	190	18122	227
17031	13	17155	230	17334	661	17451	619	17562	11	17684	188	18127	701
17034	21	17156	230	17338	529	17452	383	17563	11	17685	399	18128	701
17035	22	17159	351	17339	381	17453	367	17564	11	17686	173	18129	701
17036	150	17162	487	17341	351	17454	584	17565	11	17690	181	18132	701
17037	141	17164	528	17342	639	17455	351	17566	11	17691	182	18134	331
17038	141	17167	550	17343	508	17459	60	17567	11	17974	353	18135	331
17039	142	17169	37	17347	647	17460	28	17568	11	17975	378	18136	331
17040	140	17171	37	17348	638	17461	60	17569	11	17976	508	18137	331
17041	139	17172	177	17349	638	17462	142	17570	11	17977	259	18138	331
17042	141	17173	177	17350	596	17463	180	17571	11	17978	725	18139	331
17043	141	17174	177	17351	635	17464	163	17573	11	17979	473	18140	331
17044	141	17175	176	17353	85	17465	163	17574	11	17980	35	18141	331
17045	141	17176	351	17354	537	17466	259	17575	11	17981	580	18142	331
17046	141	17188	48	17355	348	17467	254	17576	11	17983	13	18143	331
17047	141	17189	48	17356	499	17468	256	17577	11	17988	613	18144	331
17048	141	17190	48	17358	325	17469	253	17578	11	17989	607	18145	152

NUMERICAL INDEX

Auveco No.	Page	Auveco No.	Page	Auveco No.	Page	Auveco No.	Page	Auveco No.	Page	Auveco No.	Page	Auveco No.	Page
18146	152	18324	151	18456	570	18564	96	18698	168	18836	133	18935	259
18147	152	18325	151	18457	577	18565	96	18699	168	18842	385	18936	402
18148	152	18326	151	18458	385	18567	96	18700	168	18843	664	18938	260
18149	152	18327	543	18460	4	18568	96	18701	168	18844	395	18939	613
18150	152	18329	257	18461	255	18569	96	18702	168	18846	665	18947	353
18151	152	18330	382	18463	186	18570	96	18703	168	18848	389	18948	366
18152	152	18331	261	18464	186	18571	96	18705	168	18849	222	18950	395
18153	500	18334	493	18465	201	18572	96	18706	168	18853	156	18951	635
18155	513	18335	726	18466	201	18573	96	18707	168	18855	157	18952	148
18156	35	18336	60	18467	201	18576	96	18708	168	18856	157	18953	148
18157	383	18337	107	18468	201	18579	96	18713	147	18857	157	18979	345
18163	85	18338	107	18469	201	18581	96	18716	147	18858	157	18980	48
18165	594	18339	109	18470	201	18582	96	18726	222	18859	370	18981	172
18166	382	18340	60	18472	201	18583	96	18727	240	18861	387	18982	172
18167	252	18341	88	18473	201	18585	96	18728	240	18862	398	18983	172
18168	258	18342	37	18474	201	18586	96	18729	240	18864	582	18986	172
18169	256	18343	37	18475	201	18588	96	18730	240	18865	582	18987	172
18170	261	18344	37	18476	201	18590	96	18731	240	18866	582	18988	172
18174	369	18345	38	18477	201	18592	96	18732	240	18867	177	18989	172
18175	390	18346	37	18478	201	18595	96	18733	168	18868	178	18990	172
18177	47	18347	37	18479	201	18597	96	18734	168	18870	177	19000	341
18187	47	18348	37	18482	702	18598	96	18735	168	18871	183	19001	341
18194	162	18349	38	18483	702	18599	96	18736	168	18873	677	19002	341
18202	341	18352	498	18484	37	18600	96	18737	168	18874	397	19003	341
18203	341	18353	494	18485	37	18601	96	18738	168	18875	388	19004	193
18204	341	18354	36	18486	37	18605	96	18743	244	18876	396	19006	60
18205	341	18371	370	18487	37	18607	96	18744	244	18877	381	19007	222
18206	622	18373	223	18488	37	18609	96	18746	378	18878	384	19013	676
18208	102	18374	224	18489	240	18610	96	18747	656	18880	70	19014	383
18214	188	18375	225	18498	520	18611	96	18748	499	18882	616	19016	397
18215	191	18377	518	18499	253	18612	96	18749	258	18885	328	19017	355
18216	191	18379	369	18500	253	18613	96	18750	129	18887	168	19018	355
18217	188	18383	514	18501	245	18614	96	18754	569	18888	678	19019	355
18218	194	18384	513	18502	245	18617	96	18756	568	18889	259	19020	355
18236	570	18386	528	18503	527	18618	96	18757	568	18890	532	19021	355
18237	547	18387	529	18504	529	18619	96	18758	569	18891	532	19022	355
18238	38	18389	365	18508	382	18620	96	18759	568	18892	533	19023	355
18239	38	18390	476	18509	379	18622	96	18760	569	18893	523	19024	355
18240	38	18391	390	18510	379	18624	96	18762	570	18894	523	19025	244
18241	38	18392	502	18512	597	18626	96	18764	568	18895	523	19026	244
18242	245	18393	502	18515	51	18630	96	18767	569	18896	492	19027	244
18244	257	18394	546	18518	172	18635	96	18769	36	18897	366	19028	244
18245	734	18395	498	18519	172	18636	96	18770	365	18898	106	19029	244
18246	734	18396	252	18520	172	18644	96	18771	374	18899	512	19030	244
18248	382	18398	482	18521	172	18646	331	18779	35	18900	130	19031	244
18249	547	18401	109	18522	172	18647	331	18781	59	18901	130	19033	244
18251	64	18402	498	18524	178	18650	153	18798	129	18902	130	19034	244
18252	64	18404	584	18525	181	18651	154	18799	129	18903	130	19036	244
18253	65	18405	581	18526	181	18653	154	18800	129	18904	130	19037	244
18261	59	18406	581	18527	179	18654	154	18801	129	18905	130	19045	239
18262	499	18415	588	18530	183	18658	154	18802	129	18906	130	19046	239
18263	513	18416	52	18531	81	18659	154	18803	129	18907	130	19047	239
18265	645	18417	473	18533	332	18661	203	18804	129	18908	130	19048	239
18268	493	18418	473	18534	332	18662	203	18806	129	18909	130	19049	240
18269	545	18420	476	18536	332	18665	222	18807	48	18910	130	19050	240
18270	613	18422	474	18537	332	18668	193	18808	48	18911	470	19051	240
18271	384	18423	474	18539	332	18671	192	18809	48	18912	256	19053	240
18275	375	18428	474	18540	332	18673	187	18810	260	18913	245	19055	240
18277	375	18429	473	18541	332	18674	179	18811	239	18914	532	19056	240
18294	398	18436	701	18543	332	18676	188	18812	239	18915	397	19057	240
18296	29	18437	701	18544	96	18679	374	18814	239	18916	177	19058	240
18297	383	18438	701	18545	96	18680	374	18815	367	18917	178	19060	240
18298	366	18439	701	18547	96	18682	366	18816	517	18918	180	19061	240
18299	222	18440	701	18548	96	18683	365	18817	59	18919	195	19062	248
18301	370	18441	701	18549	96	18684	365	18818	382	18920	195	19065	250
18302	365	18442	701	18550	96	18685	372	18819	189	18921	195	19066	242
18303	253	18443	701	18551	96	18688	374	18820	368	18923	176	19076	192
18304	254	18444	701	18553	96	18690	154	18822	521	18924	174	19081	354
18308	491	18445	701	18554	96	18691	495	18824	392	18925	178	19084	354
18310	493	18446	701	18555	96	18692	381	18825	537	18926	503	19095	710
18312	160	18447	701	18557	96	18693	168	18827	377	18927	257	19096	710
18316	181	18448	701	18558	96	18694	168	18829	222	18930	399	19097	710
18317	189	18449	108	18559	96	18695	168	18830	222	18931	222	19098	710
18318	178	18451	157	18561	96	18696	168	18832	521	18932	222	19099	710
18320	178	18454	597	18563	96	18697	168	18835	132	18934	32	19100	710

NUMERICAL INDEX

Auveco No.	Page	Auveco No.	Page	Auveco No.	Page	Auveco No.	Page	Auveco No.	Page	Auveco No.	Page	Auveco No.	Page
19101	51	19208	201	19314	632	19430	657	19548	66	19670	583	19766	130
19102	168	19209	204	19315	623	19435	468	19552	676	19673	366	19767	130
19103	168	19210	397	19317	39	19436	531	19554	182	19676	467	19769	130
19104	168	19213	389	19318	223	19439	577	19555	182	19677	530	19770	130
19105	168	19215	241	19320	387	19440	496	19556	181	19678	379	19771	130
19106	168	19216	64	19322	633	19441	520	19557	531	19679	587	19772	130
19107	168	19219	678	19323	384	19442	324	19558	700	19680	581	19773	225
19108	397	19220	500	19324	633	19443	324	19559	700	19682	385	19774	369
19109	393	19223	582	19325	380	19444	324	19560	700	19683	381	19775	399
19110	251	19225	567	19326	514	19445	324	19561	700	19684	381	19776	608
19111	259	19228	615	19328	635	19449	380	19562	700	19686	365	19777	35
19112	385	19231	573	19330	632	19450	616	19564	700	19687	733	19778	30
19113	384	19232	573	19331	383	19451	616	19565	700	19688	733	19779	549
19114	385	19233	573	19334	388	19452	617	19566	700	19689	733	19781	507
19115	585	19234	241	19335	484	19453	594	19568	700	19690	733	19782	507
19116	381	19235	331	19337	527	19454	588	19569	700	19691	733	19783	517
19117	586	19237	30	19338	376	19455	52	19570	700	19692	733	19786	353
19118	594	19238	516	19339	549	19456	252	19571	700	19693	733	19787	485
19120	608	19239	594	19341	337	19458	253	19572	700	19694	733	19788	485
19121	371	19240	30	19343	631	19459	256	19575	700	19695	733	19790	371
19122	384	19242	484	19345	521	19460	258	19576	136	19696	733	19791	553
19123	384	19243	484	19352	370	19461	251	19577	136	19697	733	19793	536
19124	386	19244	526	19354	370	19462	251	19578	136	19698	733	19795	496
19125	186	19245	545	19355	488	19463	571	19579	136	19701	733	19797	658
19126	186	19246	646	19356	391	19464	388	19581	187	19702	733	19798	4
19127	372	19247	467	19357	475	19465	570	19582	189	19705	733	19800	477
19128	678	19248	690	19358	473	19466	393	19587	227	19706	733	19801	489
19129	398	19250	371	19359	580	19467	383	19588	224	19707	733	19802	389
19130	223	19251	60	19361	470	19468	376	19589	223	19708	733	19804	400
19131	541	19252	703	19363	469	19470	368	19590	222	19711	733	19807	692
19132	242	19253	703	19365	227	19472	495	19591	222	19712	733	19809	105
19133	242	19254	703	19367	645	19474	632	19592	222	19713	733	19810	389
19134	242	19257	397	19368	381	19475	632	19593	222	19714	733	19812	562
19136	682	19258	145	19370	475	19476	569	19594	533	19715	733	19813	192
19138	619	19259	145	19371	371	19477	581	19595	40	19716	733	19816	345
19139	222	19260	145	19373	371	19478	569	19597	40	19718	60	19817	345
19140	635	19261	145	19374	371	19479	570	19601	222	19719	387	19818	345
19141	225	19262	145	19375	66	19480	108	19602	483	19720	382	19819	351
19142	596	19263	261	19376	256	19481	380	19603	222	19721	666	19820	478
19143	588	19265	664	19378	692	19482	608	19604	222	19722	661	19821	481
19145	394	19270	392	19379	480	19483	382	19605	222	19723	571	19822	478
19147	649	19271	138	19380	659	19484	662	19607	524	19724	382	19823	530
19149	366	19272	138	19381	479	19485	39	19613	469	19725	507	19824	70
19151	197	19273	138	19385	384	19486	464	19614	469	19726	484	19826	102
19152	548	19274	647	19386	397	19487	632	19615	491	19728	382	19831	617
19153	650	19275	391	19387	495	19490	676	19616	499	19729	384	19834	372
19154	517	19276	536	19389	474	19492	607	19617	66	19730	597	19836	366
19155	378	19277	514	19390	476	19498	352	19618	227	19731	394	19837	372
19156	192	19278	59	19393	352	19499	164	19619	227	19732	468	19838	530
19157	192	19279	225	19394	352	19501	374	19620	227	19734	588	19840	664
19162	105	19281	513	19396	260	19505	666	19621	222	19735	649	19841	665
19163	105	19282	113	19397	350	19506	367	19623	188	19736	641	19842	369
19164	105	19283	113	19398	402	19511	527	19626	691	19737	580	19843	658
19165	105	19284	113	19399	502	19514	256	19627	691	19739	678	19844	561
19166	105	19285	113	19401	358	19515	257	19628	398	19740	581	19845	375
19168	85	19286	113	19404	358	19516	261	19630	222	19741	587	19846	375
19170	60	19287	113	19406	254	19519	499	19638	546	19742	609	19847	487
19171	381	19288	113	19407	597	19522	488	19639	489	19743	618	19849	524
19176	228	19289	113	19408	596	19524	403	19640	536	19744	368	19850	380
19177	228	19290	113	19410	470	19526	517	19642	537	19745	632	19851	496
19178	228	19291	113	19411	474	19527	391	19643	368	19746	365	19853	497
19183	508	19293	640	19413	521	19529	679	19644	109	19747	622	19854	488
19186	593	19294	171	19414	251	19531	659	19645	484	19748	618	19855	370
19187	665	19295	171	19415	580	19532	379	19646	587	19749	381	19880	193
19191	548	19296	171	19416	677	19533	588	19647	658	19752	517	19881	187
19194	467	19297	487	19417	61	19534	667	19648	617	19753	619	19882	180
19195	687	19298	143	19418	380	19535	667	19650	588	19754	625	19883	189
19197	373	19299	143	19419	255	19536	529	19653	60	19755	616	19885	193
19199	166	19306	622	19420	252	19537	100	19655	378	19756	666	19887	189
19202	254	19307	587	19421	530	19538	222	19657	254	19757	476	19889	191
19203	394	19308	65	19422	544	19539	222	19658	503	19758	400	19890	186
19204	661	19309	65	19424	508	19541	373	19661	190	19759	400	19891	179
19205	65	19310	549	19425	380	19545	222	19666	332	19760	372	19892	487
19206	201	19311	596	19428	399	19546	596	19668	568	19764	130	19893	368
19207	201	19312	367	19429	467	19547	593	19669	680	19765	130	19894	539

NUMERICAL INDEX

Auveco No.	Page	Auveco No.	Page	Auveco No.	Page	Auveco No.	Page	Auveco No.	Page	Auveco No.	Page	Auveco No.	Page
19897	639	20120	563	20232	472	20338	392	20435	47	20522	475	20602	579
19898	396	20122	554	20233	524	20339	107	20437	395	20523	539	20603	578
19899	608	20123	554	20234	NI 16	20341	402	20440	666	20524	537	20604	640
19900	608	20131	560	20242	720	20342	344	20443	381	20525	537	20605	608
19904	690	20138	565	20243	720	20344	365	20444	398	20526	549	20606	65
19905	647	20139	553	20244	494	20345	375	20446	35	20527	469	20607	478
19907	677	20143	563	20245	513	20346	533	20447	70	20528	365	20608	594
19908	677	20146	558	20246	187	20347	224	20448	115	20529	469	20609	378
19910	396	20147	559	20247	594	20348	646	20449	115	20530	516	20610	397
19917	98	20149	557	20248	576	20349	677	20450	65	20531	369	20611	387
19926	554	20150	561	20250	685	20350	585	20452	467	20532	515	20612	586
19927	324	20151	557	20252	400	20351	585	20453	222	20534	679	20613	646
19928	555	20152	553	20253	401	20352	596	20454	222	20535	679	20614	638
19929	555	20153	531	20254	575	20353	479	20455	60	20536	162	20615	376
19930	554	20155	552	20256	366	20355	521	20457	545	20537	730	20616	399
19931	564	20156	559	20259	60	20356	538	20458	545	20538	730	20618	151
19932	563	20157	559	20261	52	20358	520	20459	392	20539	730	20620	202
19933	563	20158	559	20262	374	20359	490	20460	387	20540	730	20621	202
19939	563	20163	494	20263	472	20360	372	20462	222	20541	377	20623	547
19940	563	20164	378	20264	515	20362	374	20463	619	20542	489	20624	369
19941	563	20165	365	20265	486	20363	527	20464	481	20543	386	20625	375
19942	563	20166	641	20266	639	20364	30	20465	622	20544	550	20626	258
19944	555	20167	372	20267	536	20365	489	20466	468	20545	523	20627	254
19945	555	20169	527	20268	499	20366	370	20468	537	20546	530	20628	254
19947	552	20170	261	20270	576	20367	523	20469	679	20547	187	20629	256
19952	552	20171	516	20271	59	20373	1	20470	679	20548	187	20630	532
19954	555	20172	188	20272	580	20374	1	20471	496	20549	190	20631	490
19955	555	20173	549	20273	524	20375	27	20472	588	20550	187	20632	491
19957	555	20175	691	20274	389	20376	29	20473	388	20551	171	20633	395
19958	555	20176	51	20275	537	20377	478	20474	240	20552	171	20634	390
19961	563	20177	370	20276	349	20378	464	20475	156	20553	171	20635	469
19964	563	20179	536	20277	190	20380	680	20476	59	20554	171	20636	629
19966	561	20180	379	20279	402	20381	384	20477	215	20555	171	20637	629
19970	552	20181	381	20280	475	20382	60	20478	163	20556	61	20638	629
19971	563	20182	379	20281	373	20383	255	20479	262	20557	61	20639	628
19972	554	20184	368	20282	202	20386	583	20480	262	20558	392	20640	628
19973	554	20186	575	20283	202	20387	583	20481	479	20559	393	20641	628
19975	564	20187	628	20284	202	20388	576	20482	528	20559	672	20642	387
19976	561	20188	400	20285	202	20389	195	20483	528	20560	171	20643	383
19977	564	20189	372	20286	202	20390	658	20484	163	20561	192	20645	629
19982	555	20190	398	20287	202	20391	658	20485	504	20562	502	20646	627
19985	554	20191	523	20289	202	20392	521	20486	162	20563	399	20647	627
19994	562	20192	370	20290	202	20393	514	20487	162	20564	595	20649	67
20007	556	20193	521	20291	202	20394	562	20488	162	20565	633	20650	68
20008	555	20194	521	20292	202	20395	501	20489	162	20566	598	20651	67
20010	556	20195	531	20293	202	20396	500	20490	162	20567	599	20653	576
20011	556	20196	675	20294	202	20397	496	20491	162	20568	599	20654	629
20016	564	20199	626	20295	202	20399	367	20492	162	20570	65	20655	630
20030	552	20201	625	20296	202	20400	517	20493	162	20571	387	20656	626
20033	557	20202	625	20298	202	20401	531	20494	162	20572	632	20657	625
20034	557	20203	629	20299	202	20402	252	20495	162	20573	633	20659	627
20035	552	20205	626	20300	202	20404	627	20496	162	20574	706	20660	610
20038	564	20206	170	20301	36	20405	689	20497	162	20575	394	20661	608
20040	565	20207	170	20303	587	20407	690	20498	162	20576	387	20663	520
20047	564	20209	156	20308	548	20408	476	20499	162	20577	677	20665	496
20055	565	20210	156	20309	352	20409	710	20500	162	20578	659	20666	486
20068	564	20211	156	20310	524	20410	710	20501	162	20579	618	20667	537
20069	564	20212	154	20311	366	20411	591	20502	704	20580	543	20668	395
20073	565	20213	154	20313	561	20412	667	20503	704	20581	538	20669	396
20088	557	20214	154	20314	628	20415	501	20504	704	20582	104	20670	392
20089	558	20215	154	20315	627	20416	108	20505	704	20583	157	20671	384
20090	553	20216	154	20316	374	20417	478	20506	704	20585	202	20672	388
20092	554	20217	155	20318	475	20420	547	20507	704	20587	202	20673	602
20094	560	20218	155	20319	372	20421	530	20508	704	20588	202	20675	548
20097	560	20219	155	20320	170	20422	501	20509	704	20589	202	20677	578
20101	560	20220	154	20322	115	20423	501	20510	704	20590	202	20678	500
20108	556	20221	155	20324	559	20424	350	20511	704	20591	202	20680	35
20110	552	20222	155	20325	562	20425	514	20512	704	20592	202	20681	202
20111	563	20223	155	20326	476	20426	225	20514	497	20593	202	20683	203
20112	563	20224	155	20327	646	20427	399	20515	397	20595	203	20687	658
20113	563	20225	155	20328	478	20428	398	20516	525	20596	204	20688	658
20114	563	20226	155	20331	578	20429	658	20517	515	20598	204	20689	712
20115	563	20227	155	20334	369	20431	664	20518	527	20599	204	20690	712
20116	563	20230	155	20335	676	20432	597	20520	477	20600	204	20691	712
20118	563	20231	155	20336	515	20434	47	20521	479	20601	204	20694	713

NUMERICAL INDEX

Auveco No.	Page	Auveco No.	Page	Auveco No.	Page	Auveco No.	Page	Auveco No.	Page	Auveco No.	Page	Auveco No.	Page
20695	713	20798	342	20884	481	20967	545	21067	601	21143	380	21219	520
20698	340	20799	342	20885	478	20968	519	21068	600	21144	403	21220	179
20699	711	20800	342	20886	601	20970	62	21069	599	21145	687	21221	660
20700	540	20801	342	20887	541	20971	255	21070	393	21146	607	21222	211
20702	210	20802	342	20888	490	20972	477	21071	659	21147	602	21223	540
20703	210	20803	342	20889	491	20973	477	21072	504	21148	519	21224	515
20705	210	20804	342	20890	546	20974	477	21073	562	21149	393	21225	677
20706	210	20807	223	20891	482	20976	477	21074	711	21150	599	21226	671
20710	210	20808	477	20892	483	20977	520	21075	711	21151	664	21227	377
20711	210	20809	477	20893	366	20979	518	21076	711	21152	75	21228	375
20712	210	20810	477	20895	664	20981	519	21077	711	21153	540	21229	381
20715	210	20811	477	20896	222	20982	540	21078	711	21154	539	21230	519
20717	211	20813	642	20897	625	20983	393	21079	561	21155	541	21231	537
20720	210	20814	392	20898	167	20984	617	21080	82	21156	479	21232	600
20721	210	20815	156	20899	167	20986	594	21081	36	21157	482	21233	601
20722	210	20816	156	20900	731	20988	489	21082	255	21158	476	21234	660
20728	210	20817	518	20901	158	20989	490	21084	610	21159	645	21235	660
20729	210	20818	161	20902	727	20990	490	21085	637	21160	602	21236	535
20730	210	20819	161	20903	726	20991	491	21086	629	21161	482	21237	667
20734	576	20822	724	20905	727	20992	491	21087	396	21162	660	21238	487
20735	400	20823	725	20906	723	20993	492	21088	388	21164	495	21239	515
20736	641	20825	480	20907	723	20994	492	21089	523	21165	515	21240	393
20737	580	20826	490	20908	678	20995	390	21090	373	21166	172	21241	375
20738	656	20827	540	20909	629	20996	390	21091	389	21167	558	21242	479
20739	542	20828	539	20910	595	20998	391	21092	504	21168	558	21243	601
20740	258	20829	389	20912	335	20999	391	21093	224	21169	399	21244	599
20741	258	20830	256	20913	335	21000	520	21094	583	21170	574	21245	260
20742	500	20831	381	20914	335	21001	64	21095	582	21171	616	21246	486
20743	656	20834	258	20915	335	21002	146	21096	583	21172	522	21247	397
20744	656	20836	345	20916	335	21003	146	21097	638	21173	573	21248	372
20746	225	20837	185	20917	335	21004	146	21098	523	21174	519	21249	675
20747	151	20838	194	20918	335	21005	147	21099	540	21175	540	21250	398
20748	151	20839	188	20919	335	21006	176	21100	552	21176	494	21251	688
20749	151	20840	193	20920	335	21007	102	21101	562	21177	481	21252	387
20750	159	20841	188	20921	335	21008	659	21102	395	21178	222	21253	368
20751	159	20842	191	20922	335	21010	678	21103	675	21179	222	21254	386
20752	159	20843	190	20923	522	21011	676	21104	675	21180	222	21255	609
20753	647	20844	188	20924	684	21012	388	21105	386	21181	37	21256	703
20754	245	20845	193	20925	685	21013	480	21106	171	21182	37	21257	372
20755	623	20846	192	20926	370	21015	665	21107	388	21183	37	21258	222
20756	479	20847	186	20927	39	21016	659	21108	639	21184	257	21259	649
20757	667	20848	185	20928	337	21017	649	21109	579	21185	512	21260	146
20758	667	20849	189	20929	337	21019	549	21110	622	21186	578	21261	146
20759	227	20850	193	20931	677	21021	543	21111	641	21187	498	21262	146
20760	380	20851	194	20932	388	21022	350	21112	485	21188	392	21263	146
20761	370	20852	190	20933	685	21023	403	21113	255	21189	399	21264	146
20763	540	20853	187	20934	479	21024	525	21114	254	21190	595	21265	146
20764	639	20854	212	20935	480	21025	537	21115	260	21191	665	21266	146
20765	398	20855	211	20936	521	21026	371	21116	222	21192	603	21267	146
20766	545	20856	211	20937	39	21027	500	21117	638	21193	558	21268	146
20767	545	20857	211	20938	467	21028	245	21118	396	21194	657	21269	146
20768	544	20859	202	20940	546	21033	181	21119	439	21195	345	21270	147
20769	537	20860	499	20942	345	21035	548	21120	676	21196	502	21271	147
20770	385	20861	553	20943	485	21036	480	21121	637	21197	502	21272	147
20771	541	20862	518	20944	390	21037	628	21122	59	21198	518	21273	147
20773	626	20863	492	20945	558	21038	598	21123	677	21199	367	21274	147
20774	478	20864	464	20948	543	21040	107	21124	259	21200	480	21275	146
20775	477	20865	477	20949	398	21041	226	21125	380	21201	614	21276	146
20776	531	20866	403	20950	481	21042	562	21126	529	21202	518	21277	147
20782	581	20867	518	20951	481	21044	628	21127	528	21203	497	21278	146
20783	579	20868	481	20952	478	21045	558	21128	478	21204	567	21279	146
20784	579	20869	676	20953	647	21046	257	21129	479	21205	587	21280	146
20785	579	20870	540	20954	587	21047	224	21130	478	21206	394	21281	146
20786	641	20872	503	20955	678	21048	48	21131	398	21207	578	21282	147
20787	254	20873	637	20956	681	21049	48	21132	660	21208	393	21283	147
20788	253	20874	375	20957	617	21050	48	21133	660	21209	571	21284	498
20789	169	20875	608	20958	617	21051	48	21134	646	21210	185	21285	637
20790	641	20876	608	20959	394	21052	48	21135	224	21211	378	21286	NI 5
20791	712	20877	608	20960	617	21053	48	21136	599	21212	178	21287	375
20792	342	20878	371	20961	637	21054	48	21137	392	21213	537	21288	376
20793	342	20879	394	20962	538	21055	48	21138	395	21214	529	21289	395
20794	342	20880	490	20963	546	21056	48	21139	393	21215	531	21290	501
20795	342	20881	387	20964	538	21059	397	21140	635	21216	580	21291	637
20796	342	20882	384	20965	520	21064	599	21141	592	21217	660	21292	600
20797	342	20883	499	20966	544	21066	600	21142	260	21218	675	21293	223





















NUMERICAL INDEX

Auveco No.	Page	Auveco No.	Page	Auveco No.	Page	Auveco No.	Page	Auveco No.	Page	Auveco No.	Page	Auveco No.	Page
21294	678	21371	606	21447	683	21528	541	21604	172	21680	NI 13	21756	NI 8
21295	382	21372	607	21448	683	21529	490	21605	609	21681	NI 10	21757	NI 14
21296	383	21373	259	21449	683	21530	654	21606	37	21682	NI 29	21758	NI 32
21297	594	21374	479	21450	388	21531	652	21607	37	21683	NI 24	21759	NI 22
21299	476	21375	482	21451	687	21532	390	21608	37	21684	NI 28	21760	NI 32
21300	515	21376	546	21452	688	21533	698	21609	35	21685	NI 28	21761	NI 31
21301	372	21377	495	21453	657	21534	324	21610	505	21686	NI 30	21762	NI 14
21302	495	21378	601	21454	595	21535	391	21611	680	21687	NI 31	21763	NI 14
21303	367	21379	399	21456	689	21536	391	21612	659	21688	NI 23	21764	NI 14
21304	516	21380	376	21457	605	21537	608	21613	681	21689	NI 25	21765	NI 14
21305	688	21381	380	21458	365	21538	672	21614	681	21690	NI 23	21766	NI 13
21306	517	21382	379	21459	649	21540	107	21615	681	21691	NI 27	21767	NI 13
21307	385	21383	390	21464	625	21541	60	21616	680	21692	NI 29	21768	NI 24
21308	567	21384	469	21465	626	21542	181	21617	638	21693	NI 29	21769	NI 22
21309	648	21385	377	21466	625	21543	583	21618	637	21694	NI 29	21770	NI 20
21310	547	21386	377	21467	626	21544	664	21619	637	21695	NI 29	21771	NI 26
21311	646	21387	498	21468	625	21545	646	21620	645	21696	NI 17	21772	NI 16
21312	599	21388	574	21469	626	21546	657	21621	640	21697	NI 27	21773	NI 17
21313	376	21390	682	21470	578	21547	677	21622	641	21698	NI 27	21774	NI 2
21314	608	21391	687	21471	324	21548	365	21623	657	21699	NI 27	21775	NI 14
21315	260	21392	372	21472	171	21549	657	21624	676	21700	NI 16	21776	NI 15
21316	476	21393	403	21473	171	21550	658	21625	609	21701	NI 25	21777	NI 15
21317	145	21394	683	21474	171	21551	386	21626	383	21702	NI 30	21778	NI 16
21318	641	21395	683	21475	171	21552	380	21627	365	21703	NI 12	21779	NI 16
21319	520	21396	684	21476	171	21553	680	21628	663	21704	NI 17	21780	NI 16
21320	255	21397	685	21477	595	21554	394	21629	652	21705	NI 17	21781	NI 16
21321	599	21398	403	21478	684	21555	579	21630	368	21706	NI 17	21782	NI 14
21322	653	21399	685	21479	687	21556	579	21631	646	21707	NI 17	21783	NI 32
21324	640	21400	494	21480	684	21557	578	21632	535	21708	NI 32	21784	NI 33
21325	676	21401	157	21481	683	21558	579	21633	381	21709	NI 23	21785	NI 33
21326	NI 4	21402	239	21482	688	21559	578	21634	384	21711	NI 22	21786	NI 33
21327	245	21403	505	21483	688	21560	368	21635	586	21712	NI 27	21787	NI 15
21328	601	21404	505	21484	605	21561	616	21636	580	21713	NI 5	21788	NI 15
21329	395	21405	506	21485	688	21562	651	21637	648	21714	NI 4	21789	NI 32
21330	602	21406	506	21487	507	21563	655	21638	393	21715	NI 5	21790	NI 11
21331	665	21407	550	21488	387	21564	651	21639	579	21716	NI 23	21791	NI 12
21332	368	21408	550	21489	388	21565	380	21640	396	21717	NI 1	21792	NI 28
21333	398	21409	506	21490	178	21566	654	21641	659	21718	NI 1	21793	NI 9
21334	380	21410	392	21491	683	21567	388	21642	660	21719	NI 1	21794	NI 12
21335	482	21411	667	21492	683	21568	655	21643	383	21720	NI 1	21795	NI 30
21336	679	21412	389	21493	682	21569	652	21644	505	21721	NI 1	21796	NI 16
21337	680	21413	618	21494	400	21570	654	21645	576	21722	NI 1	21797	NI 31
21338	373	21414	394	21495	387	21571	654	21646	648	21723	NI 1	21798	NI 4
21339	162	21415	403	21496	387	21572	651	21647	222	21724	NI 1	21799	NI 5
21340	162	21416	682	21497	385	21573	382	21648	222	21725	NI 1	21800	NI 34
21341	162	21417	572	21498	684	21574	393	21649	222	21726	NI 1	21801	NI 34
21342	162	21418	253	21499	575	21575	652	21650	225	21727	NI 1	21802	NI 34
21343	162	21419	579	21500	655	21576	444	21651	594	21728	NI 1	21803	NI 34
21344	162	21420	655	21501	655	21577	652	21652	378	21729	NI 1	21804	NI 34
21345	162	21421	376	21502	396	21578	655	21653	658	21730	NI 1	21805	NI 34
21346	390	21422	654	21503	481	21579	652	21654	395	21731	NI 1	21806	NI 34
21347	466	21423	574	21504	479	21580	655	21655	242	21732	NI 1	21807	NI 34
21348	546	21424	158	21505	609	21581	651	21656	242	21733	NI 1	21808	NI 35
21349	367	21425	602	21506	518	21582	506	21657	607	21734	NI 1	21809	NI 35
21350	367	21426	63	21507	518	21583	665	21658	NI 26	21735	NI 1	21810	NI 35
21351	501	21427	543	21508	682	21584	392	21659	631	21736	NI 1	21811	NI 35
21352	224	21428	468	21509	387	21585	654	21661	367	21737	NI 1	21812	NI 34
21353	224	21429	575	21510	684	21586	659	21662	621	21738	NI 12	21813	NI 35
21354	224	21430	575	21511	731	21587	652	21663	621	21739	NI 10	21814	NI 34
21355	601	21431	576	21512	683	21588	385	21664	649	21740	NI 11	21815	NI 33
21356	599	21432	575	21513	688	21589	367	21665	223	21741	NI 11	21816	NI 35
21357	611	21433	625	21514	688	21590	652	21666	540	21742	NI 4	21817	NI 35
21358	610	21434	626	21515	685	21591	388	21667	480	21743	NI 21	21818	NI 36
21359	680	21435	626	21516	390	21592	654	21668	519	21744	NI 2	21819	NI 36
21360	394	21436	172	21517	61	21593	654	21669	518	21745	NI 8	21820	NI 23
21361	493	21437	172	21518	469	21594	655	21670	540	21746	NI 2	21821	NI 29
21362	514	21438	172	21519	366	21595	485	21671	476	21747	NI 2	21822	NI 35
21363	605	21439	257	21520	385	21596	678	21672	490	21748	NI 28	21823	NI 22
21364	388	21440	261	21521	588	21597	580	21673	368	21749	NI 3	21824	NI 24
21365	387	21441	626	21522	519	21598	172	21674	467	21750	NI 3	21825	NI 9
21366	678	21442	547	21523	519	21599	172	21675	393	21751	NI 3	21826	NI 11
21367	640	21443	376	21524	500	21600	172	21676	394	21752	NI 3	21827	NI 10
21368	514	21444	506	21525	614	21601	545	21677	222	21753	NI 8	21828	NI 3
21369	657	21445	529	21526	349	21602	172	21678	NI 21	21754	NI 8	21829	NI 3
21370	480	21446	245	21527	631	21603	172	21679	NI 12	21755	NI 21	21830	NI 3













NUMERICAL INDEX

Auveco No.	Page	Auveco No.	Page	Auveco No.	Page	Auveco No.	Page	Auveco No.	Page	Auveco No.	Page	Auveco No.	Page
21831.....	NI 3	22014.....	NI 18	22059.....	NI 23	22104.....	NI 1	22149.....	NI 21	70132.....	286	71117.....	286
21832.....	NI 3	22015.....	NI 18	22060.....	NI 25	22105.....	NI 3	22150.....	NI 20	70133.....	286	71118.....	286
21833.....	NI 3	22016.....	NI 19	22061.....	NI 24	22106.....	NI 2	22151.....	NI 20	70134.....	286	71119.....	286
21834.....	NI 3	22017.....	NI 19	22062.....	NI 13	22107.....	NI 24	22152.....	NI 21	70135.....	286	71120.....	286
21835.....	NI 12	22018.....	NI 18	22063.....	NI 25	22108.....	NI 33	22153.....	NI 21	70136.....	286	71121.....	286
21836.....	NI 17	22019.....	NI 18	22064.....	NI 21	22109.....	NI 14	22154.....	NI 20	70137.....	286	71122.....	286
21837.....	NI 2	22020.....	NI 18	22065.....	NI 8	22110.....	NI 2	22155.....	NI 21	70138.....	286	71123.....	286
21838.....	NI 2	22021.....	NI 9	22066.....	NI 5	22111.....	NI 2	22156.....	NI 21	70139.....	286	71124.....	286
21839.....	NI 2	22022.....	NI 10	22067.....	NI 5	22112.....	NI 17	22157.....	NI 20	70140.....	286	71125.....	286
21840.....	NI 1	22023.....	NI 5	22068.....	NI 17	22113.....	NI 3	22158.....	NI 29	70141.....	286	71126.....	286
21841.....	NI 2	22024.....	NI 10	22069.....	NI 17	22114.....	NI 3	22159.....	NI 29	70142.....	286	71127.....	286
21842.....	NI 32	22025.....	NI 9	22070.....	NI 1	22115.....	NI 22	22160.....	NI 26	70143.....	286	71128.....	286
21843.....	NI 22	22026.....	NI 8	22071.....	NI 9	22116.....	NI 31	70000.....	286	70144.....	286	71129.....	286
21844.....	NI 5	22027.....	NI 10	22072.....	NI 31	22117.....	NI 8	70100.....	286	70145.....	286	71130.....	286
21845.....	NI 7	22028.....	NI 12	22073.....	NI 30	22118.....	NI 3	70101.....	286	70146.....	286	71131.....	286
21846.....	NI 28	22029.....	NI 10	22074.....	NI 3	22119.....	NI 3	70102.....	286	70147.....	286	71132.....	286
21847.....	NI 28	22030.....	NI 2	22075.....	NI 25	22120.....	NI 3	70103.....	286	70148.....	286	71133.....	286
21848.....	NI 28	22031.....	NI 9	22076.....	NI 24	22121.....	NI 11	70104.....	286	70149.....	286	71134.....	286
21849.....	NI 30	22032.....	NI 24	22077.....	NI 23	22122.....	NI 5	70105.....	286	70150.....	286	71135.....	286
21850.....	NI 25	22033.....	NI 11	22078.....	NI 27	22123.....	NI 24	70106.....	286	70151.....	286	71136.....	286
21851.....	NI 15	22034.....	NI 9	22079.....	NI 27	22124.....	NI 11	70107.....	286	70152.....	286	71137.....	286
21853.....	NI 32	22035.....	NI 11	22080.....	NI 10	22125.....	NI 30	70108.....	286	70153.....	286	71138.....	286
21854.....	NI 15	22036.....	NI 10	22081.....	NI 1	22126.....	NI 29	70109.....	286	70154.....	286	71139.....	286
21855.....	NI 20	22037.....	NI 10	22082.....	NI 23	22127.....	NI 28	70110.....	286	70155.....	286	71140.....	286
21856.....	NI 30	22038.....	NI 11	22083.....	NI 27	22128.....	NI 25	70111.....	286	70156.....	286	71141.....	286
21857.....	NI 27	22039.....	NI 25	22084.....	NI 14	22129.....	NI 12	70112.....	286	70157.....	286	71142.....	286
21858.....	NI 22	22040.....	NI 8	22085.....	NI 20	22130.....	NI 16	70113.....	286	70158.....	286	71143.....	286
21859.....	NI 22	22041.....	NI 9	22086.....	NI 16	22131.....	NI 6	70114.....	286	70159.....	286	71144.....	286
21860.....	NI 30	22042.....	NI 26	22087.....	NI 13	22132.....	NI 29	70115.....	286	71000.....	286	71145.....	286
21861.....	NI 6	22043.....	NI 26	22088.....	NI 4	22133.....	NI 13	70116.....	286	71101.....	286	71146.....	286
21862.....	NI 22	22044.....	NI 26	22089.....	NI 4	22134.....	NI 4	70117.....	286	71102.....	286	71147.....	286
21863.....	NI 18	22045.....	NI 3	22090.....	NI 15	22135.....	NI 18	70118.....	286	71103.....	286	71148.....	286
21864.....	NI 4	22046.....	NI 26	22091.....	NI 15	22136.....	NI 17	70119.....	286	71104.....	286	71149.....	286
21865.....	NI 2	22047.....	NI 26	22092.....	NI 15	22137.....	NI 33	70120.....	286	71105.....	286	71150.....	286
22003.....	NI 19	22048.....	NI 26	22093.....	NI 21	22138.....	NI 33	70121.....	286	71106.....	286	71151.....	286
22004.....	NI 19	22049.....	NI 22	22094.....	NI 33	22139.....	NI 6	70122.....	286	71107.....	286	71152.....	286
22005.....	NI 19	22050.....	NI 26	22095.....	NI 32	22140.....	NI 14	70123.....	286	71108.....	286	71153.....	286
22006.....	NI 19	22051.....	NI 29	22096.....	NI 28	22141.....	NI 14	70124.....	286	71109.....	286	71154.....	286
22007.....	NI 18	22052.....	NI 16	22097.....	NI 31	22142.....	NI 14	70125.....	286	71110.....	286	71155.....	286
22008.....	NI 19	22053.....	NI 12	22098.....	NI 31	22143.....	NI 4	70126.....	286	71111.....	286	71156.....	286
22009.....	NI 19	22054.....	NI 17	22099.....	NI 11	22144.....	NI 6	70127.....	286	71112.....	286	71157.....	286
22010.....	NI 18	22055.....	NI 24	22100.....	NI 9	22145.....	NI 20	70128.....	286	71113.....	286	71158.....	286
22011.....	NI 19	22056.....	NI 30	22101.....	NI 32	22146.....	NI 6	70129.....	286	71114.....	286	71159.....	286
22012.....	NI 19	22057.....	NI 15	22102.....	NI 31	22147.....	NI 6	70130.....	286	71115.....	286	71160.....	286
22013.....	NI 18	22058.....	NI 12	22103.....	NI 29	22148.....	NI 20	70131.....	286	71116.....	286		



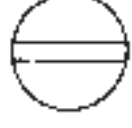







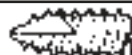

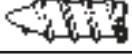

HEAD STYLES

 Binding - undercut unless otherwise specified -not recommended for phillips recess	 Fillister - deep slot used for counter bored holes	 Flat Fillister - same as standard fillister without oval top	 Flat 82+ - used where flush surface is desired	 Flat 100+ - larger head than 82° used for thin metal soft plastic
 Flat Trim - same as 82+ except diameter and countersink depth reduced	 Flat Undercut - standard 82+ with lower 1/3 countersink removed for short screws	 Hexagon - manufactured as trim hex or indented hex	 Hex Washer - same as hexagon with washer section	 Oval - same as flat head with rounded surface for appearance
 Oval Undercut - similar to flat undercut with rounded surface	 Oval Trim - same as oval - smaller diameter and countersink	 Pan - recommended to replace round, truss binder	 Round - general purpose (see pan head)	 Round Countersunk - bolts only - similar to flat head with no driving recess
 Round Washer same as round head with integral washer for bearing surface.	 Square - bolts only - large bearing surface for wrench tightening	 Square Countersunk - for use on plow bolts	 Square (Set Screw) - recommended for high torque assembly	 Truss - similar to round head with larger diameter (see pan head)

DRIVING RECESS

CROSS-RECESSED (PHILLIPS)		SQUARE SOCKET	
POZI-DRIV		SLOT & SQUARE SOCKET	
FREARSON		INDENT HEX WASHER	
PHILLIPS & SLOT		INDENT SLOTTED HEX WASHER	
SLOT		PHILLIPS PYRAMID	
CROSS-SLOT		CLUTCH	
		TORX®	

POINT STYLES

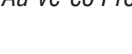
TYPE AB	
TYPE 17	
TYPE BP	
TYPE A	
TYPE B	
TYPE BT(25)	
TYPE C	
TYPE T(23)	
TYPE D(1)	
TYPE F	
TYPE G	
TYPE BF	
TYPE U	
TYPE TT	
TYPE CA	
DOG POINT	

Refer to the listing opposite page 1 for head illustrations by size.

FASTENER TERMINOLOGY

Bolt: An externally threaded, headed fastener. Difference between a bolt and a screw is: a bolt is generally used through a hole with a mating nut; a screw is used in a threaded hole without a nut.

Class Of Thread: A system used to distinguish thread tolerance differences. Classes 1A, 2A, and 3A apply to external threads, and 1B, 2B, and 3B to internal threads. Classes 2 and 3 apply to both external and internal threads.

Crest: The outermost tip of male thread from the fastener cylinder, or innermost tip of female thread.

Driving Recess: A recess in the fastener head designed to accept a driving tool.

External Thread: The male thread. Thread outside of the cylinder surface.

Internal Thread: Female thread. Thread on the inside surface of a cylinder or cone.

Left-Hand Thread: Thread that winds counter-clockwise from the starting end of a fastener.

Major Diameter: The largest diameter of a screw thread, on a straight thread it is the diameter of an imaginary cylinder which would pass through the crest of an external thread or the root of an internal thread.

Minor Diameter: On a straight thread it is the diameter of an imaginary cylinder bounding the root of an external thread or the crest of an internal thread.

Nominal Diameter: Basic diameter that determines the size and dimensional limits of fasteners.

Pitch: Distance from a point of a screw thread to a corresponding point on the next thread measured parallel to the axis.

Right-Hand Thread: A thread that winds clockwise from the starting end of a fastener (when viewed from the starting end).

Screw: A headed fastener which is externally threaded.

Sems®: A term applied to preassembled screw and washer assemblies. Washers are placed on screws before roll threading. Threads being of larger diameter than the washer hole thus prevent the washer from slipping off the screw.

Stud: A threaded rod - at both ends or for entire length.

Tapping Screw: A hardened thread screw made to cut or form its own mating thread in an untapped hole.

Teks®: A screw which drills its own hole and then threads in.

Thread Pitch: The distance from the crest of one thread to crest of another.

PLATINGS AND FINISHES

Finish	Color	Anti-Corrosion Properties	Characteristics And Uses		
Black Oxide	Black	Good (Interior Only) - 8 Hr. Salt Spray	Most Metals	Decorative finish. Used only on interior applications.	
Black Zinc	Black	Excellent - 72 Hour Salt Spray	All Metals	Rich and lustrous. With or without lacquering.	
Cadmium	Bright Silver-Gray Dull or Burnished	Very Good - 24 Hour Salt Spray	Most Metals	Non-porous metallic plating. Rich appearance, good rust resistance, low cost, good electrical conductivity. Bright silver-gray dull gray or black electroplated finish.	
Chromium (Chrome)	Bright Blue-White	Excellent - 24 Hour Salt Spray	All Metals	Used when a beautiful finish is desired. Bright blue-white lustrous appearance. Electroplated.	
Dichromate Dip	Rainbow	Excellent	All Metals	A yellow, brown, green or iridescent colored coating. Increases rust resistance. Add to Zinc or Cadmium plating.	
E-Coat	Black	Excellent - 168 Hour Salt Spray	All Metals	Added protection containing corrosion inhibitors. Excellent for exterior applications.	
Iridite	Green Olive drab Bronze	Blue Red Black	Excellent	All Metals	Coloring dip which adds rust resistance. Usually applied on Zinc or Cadmium.
JS-500	Chrome-like luster	Excellent - 500 Hour Salt Spray	All Metals	Outstanding corrosion resistant finish that provides economical corrosion protection without adversely affecting dimensions.	
Mechanical Zinc	Gray	Very Good - 48 Hour Salt Spray	All Metals	A chemical process of rust-proofing steel.	
Nickel	Silver	Very Good - 24 Hour Salt Spray	All Metals	A hard, stable, dull white or bright burnished finish. Used for appliances and hardware.	
Parkerized	Black	Excellent - 72 Hour Salt Spray	Ferrous Metals	Added protection when oiled with a non-drying petroleum oil containing corrosion inhibitors. Good lubricity.	
Phosphating	Dull, Gray, Black, or Blue	Excellent - 72 Hour Salt Spray	Ferrous Metals	A chemical process of rust-proofing steel.	
Passivating	_____	Excellent	Stainless Steels	For stainless steels. A nitric acid dip to remove foreign material and brighten finish.	
Zinc Electrogalvanized	Gray	Very Good - 24 Hour Salt Spray	All Metals	Good rust resistance, appearance & low cost.	
Zinc Electroplated	Blue To Blue-White-Gray	Very Good - 24 Hour Salt Spray	All Metals	Commonly used finish.	

TAPPING SCREWS

Diameter, Head Size & Length Identification

Oval Head Tapping Screws

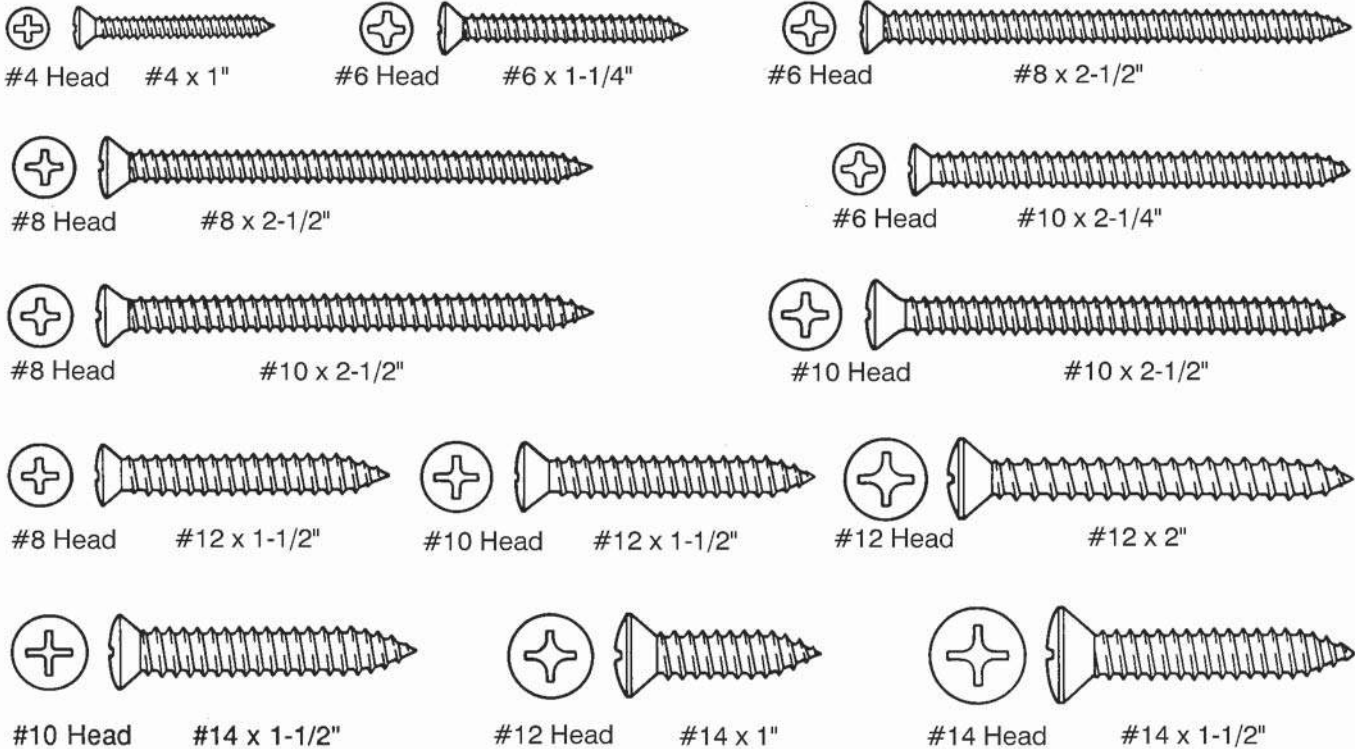

Pan Head Tapping Screws

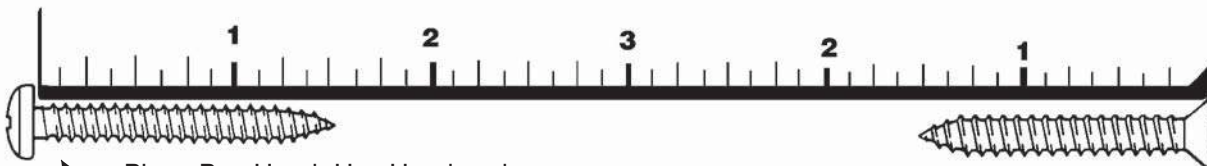
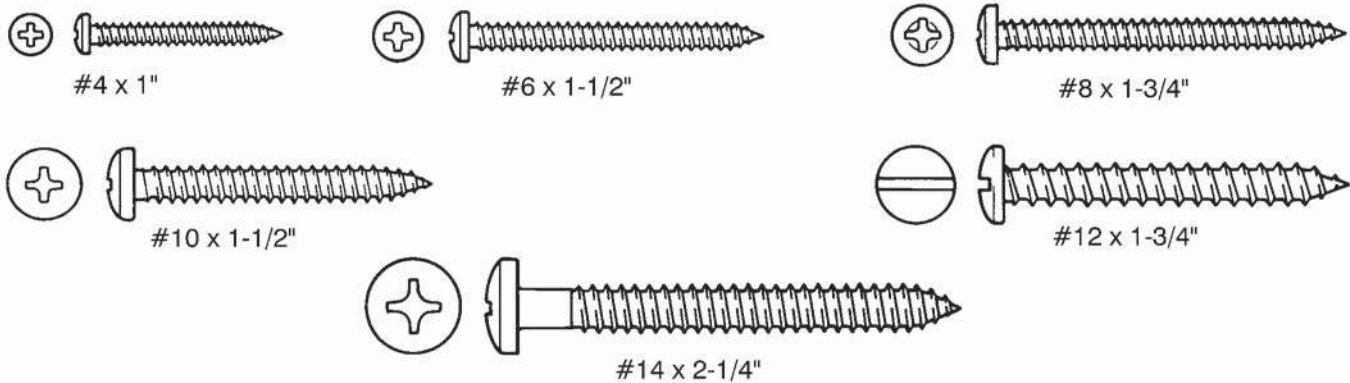

Place Pan Head, Hex Head and Hex Washer Head Screws At This End To Measure The Length (Under The Head)

Place Oval Head and Flat Head Screws In The Blackened Area To Measure The Length

Auveco Apparel And Promotional Items

Make your customers aware that you use the best Body Hardware & Specialty Fasteners in the Industry. Promotional Products and Apparel bearing the Auveco logo promote your identity as a Professional. You can select from caps, shirts, jackets, pens, coffee mugs, Post-It® note pads, golf balls, clocks, air fresheners and more.



The availability of Auveco Apparel and Promotional Items constantly changes as we add new items. Call your Auveco Customer Service Representative, or go to www.auveco.com for the most up-to-date listing of Apparel and Promotional Items.

Today



1980



1916



WORLD'S LARGEST SELECTION OF AUTOMOTIVE BODY HARDWARE & SPECIALTY FASTENERS SERVICING THE AUTOMOTIVE, PBE, INDUSTRIAL & MRO MARKETS

In 2016 Auveco (Auto Vehicle Parts Co.) will have been manufacturing and distributing specialty automotive and industrial fasteners for **100 years**. Originally, Auto Vehicle Parts Co. manufactured trim parts and accessories for horse drawn carriages. Still family owned and now four generations later, Auveco is the World's Leader in servicing our customer's needs for body hardware and specialty fasteners through our worldwide Distributors. We market our products through traditional channels of distribution, selling only to authorized Distributors and O.E. manufacturers, in three types of packaging: small "unit package" quantities, a one price "retail program" for the "PBE" Jobber store and in large "bulk quantities" for the Expeditor / Distributor and O.E. manufacturer. In addition we offer a variety of different types of assortments and merchandising aids to ensure that all the customer's needs are met.

From a humble first edition of 50 pages and 56 items, the Auveco catalog has evolved into this current version of more than 800 pages covering over 20,000 different items. While this evolution has resulted in a catalog that is light years different from the initial publication, there is one characteristic that remains as true today as it was back then. The Auveco catalog is still regarded as **THE ENCYCLOPEDIA OF THE AUTOMOTIVE BODY HARDWARE INDUSTRY**. The company's goal also remains the same as it was a century ago: **COMPLETE CUSTOMER SATISFACTION WITH OUR PRODUCTS AND SERVICE**. To maintain this lofty level of excellence we go beyond just a dedication to product availability. Of course we continually add to our product line on an almost biweekly basis but we insist upon a dedication to quality of services at all levels throughout the company as well.

We realize we must constantly improve in order to be true to our commitment to **COMPLETE CUSTOMER SATISFACTION**. This means implementing the latest technologies to improve our ability to provide for our customers' ever-changing needs. Not only do we continually upgrade our warehouse fulfillment system to achieve improvements in accuracy and order turnaround but we also continually upgrade our web site with features that enhance our ability to serve our distributors and their customers. This includes updating code that further enhances speed, stability and ability to address more of our customers' needs as well as upgrading Internet Bandwidth and supporting servers. We have seen tremendous growth in the number of distributors who rely on the 24/7 availability of the site to check stock, place and track orders, request quotes and utilize the most complete and current product information.

Web site users receive priority in our fulfillment process as orders typically are available within one hour from being entered.

Along with the increase of the eCommerce web site usage, we have seen a tremendous growth in the number of customers utilizing our EDI capabilities. We are actively trading Purchase Order, PO Acknowledgement, Advanced Shipping Notices (ASN) and Invoice documents with a growing group of trading partners. We welcome EDI inquires and provide features on our eCommerce site that enable the quick and easy upload of electronic order files directly into our system.



We continue to enhance and add features to our FasTrack Web internet based Cost Recovery software which is utilized by thousands of satisfied Body Shop users.

Our Customer Service and Technical Staff are fully trained to make sure that we can answer all your questions regarding product availability, pricing, delivery and technical information. We can even supply detailed, custom sales analysis to guide customers in the selection of new products that ensures their sales growth.

All these improvements, coupled with our ever-expanding selection of in-stock automotive hardware and our world class customer service, are designed to make Auto Vehicle Parts Co. **Your One Stop Source For Body Hardware and Specialty Fasteners**. What can you expect in the future? Our goal of further enhancing customer satisfaction is limited only by our imagination and your needs. Let us know what we can do to better serve you. We never stop trying to provide the best products and service for our customers.

As we continually strive to service our customers across the country and beyond, it's no wonder that when people around the world think of Automotive Body Hardware & Specialty Fasteners, they think of:



Auveco: From Manufacturing to Distribution



To Total Customer Satisfaction



<http://www.auveco.com>



24/7 access to:

- * Place Orders
- * Track Orders
- * Check stock
- * Check account status
- * View the most up-to-date information on new items, promotions and trade shows
- * Look up parts by O.E.M. number, competitive number, customer number & description
- * Verify product specifications
- * Utilize "FasTrack Web" the internet based recovery software system



“AuvecoPak” Retail Package Program

448 Fast Moving Retail Items



Body Hardware & Specialty Fasteners

For more detailed information on the AuvecoPak Retail Package Program, refer to pages 263-269



Over 450 Pre-Packaged Assortments
 For Every Customer's Needs
 (Refer to Section 15 - the green pages)



FasTrack Web...

A Cost Recovery System for
Automotive Body Fasteners
Used in Over 3,500 Collision Repair Facilities

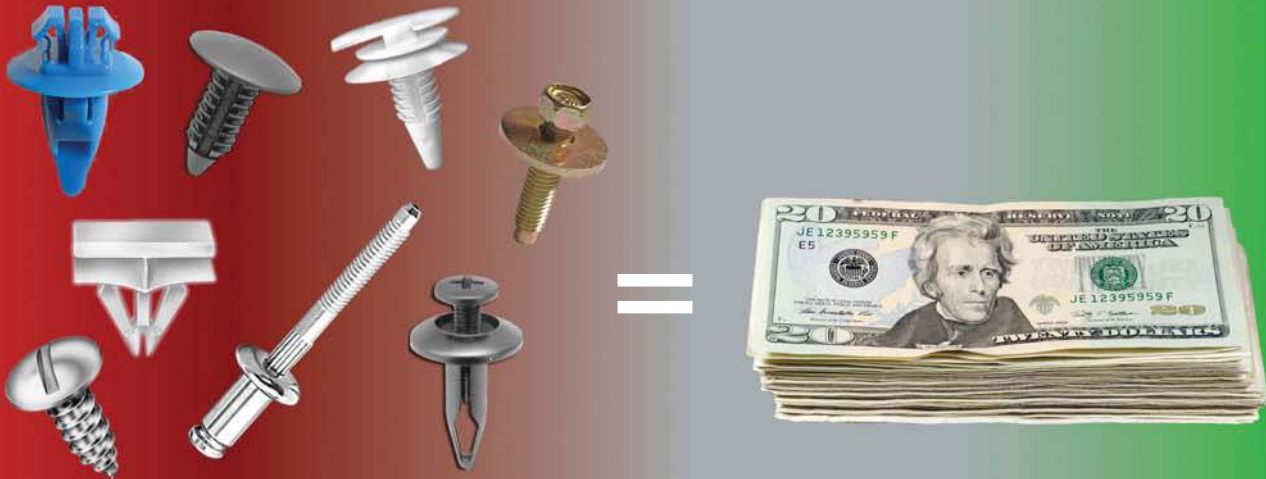

According to body shop managers, almost 100% of the vehicles being repaired require additional items be added to the initial estimate. That's typically because fasteners weren't included in the estimate or because there was hidden damage and something was missed or forgotten during the estimating process. Rather than lose money on these items, the body shop needs to create a **supplemental invoice** to submit to the insurance company to cover the cost of the additional items.

Fastrack Web is the solution to that situation. It's an easy-to-use, web based application that enables Collision Repair Shops to quickly create an invoice for those items that need to be "added on" after the work has begun. Everything from fasteners to seam sealer to tapes to sand paper and more can be included on the supplemental invoice. No longer are they a profit draining cost of doing business for the body shop.

Fastrack Web includes over **10,000 Auveco Body Hardware and Specialty Fasteners** items. 10,000 items that are **pre-loaded** with a crossover to **O.E.M. part numbers with O.E.M. List Prices**. Thus the supplemental invoices are computed at the manufacturer specific O.E.M. price which provides a standardized cost basis preferred by insurance companies.

A **Technician Usage Sheet** makes it quick and easy for the tech to keep track of any items that are missing on the estimate. Down time can be further minimized if the tech uses a **bar code scanner** (we offer a **DataLogic** scanner) to speed up the process of compiling the additional items used in the repair of the vehicle.

FasTrack Web's **vast array of additional features** also includes the ability to **manage inventory**, **email orders** to a distributor, as well as **complete usage reporting**. Features geared toward helping keep profit percentages in the black.

Auveco's FasTrack Web is today's cutting edge technology and you can be sure we will continue to improve the product so that it's always the "best in the business".

For more information on Fastrack call **800.354.9816 ext 103** or visit our www.auveco.com website where you can sign up for a **Free 2-Month Trial** and view the **tutorial video** under "**FasTrack Information**"

Auveco Is The Complete Fastener Line With Over 20,000 Items.



We Offer All Types of Custom Packaging Capabilities
To Meet Your Distribution Needs.

New "428" PLUS SYSTEM New

A surefire way to boost your sales. There is no better aid in identifying automotive body hardware and specialty fasteners than the Auveco display boards

DB-420-0
Display Board Binder
that holds up to 8 boards

DB-428-1
Retainers &
Push Type Retainers

DB-428-2
Push-Type Retainers

DB-428-3
Tapping Screws

DB-428-4
Body Bolts, Nuts & Shims

DB-428-5
Speed Nuts, Nylon Nuts,
Thread Cutting Nuts,
Push-On Retainers &
Pushnut Bolt Retainers

DB-428-6
Speciality Rivets,
Door Hinge Pins &
Bushings, Trim Clips
& Fasteners

DB-428-7
Moulding Clips,
Wire Loom Clips,
Vacuum Caps, Plastic
Plugs & Cable Straps

DB-428-8
Assortment of one each of
DB-428-1 through
DB-428-7

DB-428-9
Display Board Binder
and one each of DB-428-1
through DB-428-7



428 very popular body hardware and fastener items shrink-wrapped onto seven convenient, time-saving 11" wide by 14" long display boards. These seven boards represent the parts that we recommend every distributor should be stocking and selling to all the body shops. While they don't necessarily contain "depth of coverage" within particular product groups, they do cover all the different body shop product groups.

The back of each board contains the appropriate information on part numbers, unit package quantities, OEM numbers and size specifications. The backs are protected by a clear plastic liner.

All Numbers Are UNIT PACKAGE: 1



Celebrating 100 Years

Founded in 1916, Auveco started as a manufacturer of trim parts and accessories for horse drawn carriages. After three generations, Auveco is still family owned and now distributes the world's largest selection of specialty automotive and quality industrial fasteners. Our company goal remains the same as it was a century ago: **Complete Customer Satisfaction with our Products and Service.**



Original Auveco Building, 1916



Auveco, 2016



Auto-Vehicle Parts Co.

Cold Spring, KY 41076 (Metropolitan Cincinnati)

Sold Through Authorized Distributors